

2025
2026



MEASURING INSTRUMENTS

CATALOGUE NO. 208



QUALITY | INNOVATION | SERVICE | VALUE



The products with this mark are **INSIZE PLUS** brand, otherwise the products are **INSIZE** brand.

INSIZE is our standard quality

INSIZE PLUS is our premium quality



Please scan QR code to watch the videos of products.

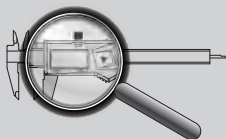

How to search:

1. Search for products according to category in PRODUCT INDEX (next 7 pages)
2. Search for products in CODE NO. INDEX (page 1216-1223)
3. Search for products in APPLICATION INDEX OF MEASURING TOOLS (page 1224-1230)



We reserve the right to change or modify the design and specification of products in this catalogue without prior notice.

Copyright © INSIZE CO., LTD. All Rights Reserved.
INSIZE is the registered trademark of INSIZE CO., LTD.

PRODUCT INDEX

1 DATA OUTPUT AND SOFTWARE

PAGE 1-27

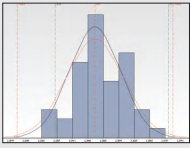

DATA MANAGEMENT SOFTWARES



DATA OUTPUT CABLES



MOBILE WORKBENCHES

2 CALIPERS

PAGE 28-83

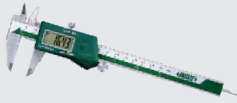

CALIPERS

3 DEPTH MEASURING TOOLS

PAGE 84-100

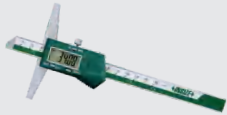

DEPTH GAUGES



DEPTH GAUGES



DEPTH MICROMETERS

4 HEIGHT MEASURING TOOLS

PAGE 101-110



DIGITAL HEIGHT GAUGES



HEIGHT GAUGES

5 COMPARISON MEASURING TOOLS

PAGE 111-126



CARBON FIBER COMPARISON GAUGES



INTERNAL/EXTERNAL MEASURING GAUGES



INTERNAL AND EXTERNAL DIAMETER COMPARISON INSTRUMENTS



OUTSIDE DIAMETER MEASURING STANDS

6 MICROMETERS

PAGE 127-196



DIGITAL MICROMETERS/SNAP GAUGES



OUTSIDE MICROMETERS



SPECIAL PURPOSE MICROMETERS



3-WIRES



MICROMETER HEADS

7 BORE DIAMETER AND CIRCUMFERENCE MEASURING TOOLS

PAGE 197-232



INSIDE MICROMETERS



INSIDE MICROMETERS



THREE POINTS INTERNAL MICROMETERS



BORE PLUG GAUGES



BORE GAUGES



CARBON FIBER BORE GAUGES



INTERNAL CHAMFER GAUGES



TELESCOPING GAUGE SETS



CIRCUMFERENCE METERS

8 ARC RADIUS MEASURING TOOLS

PAGE 233-239



OUTSIDE DIAMETER VARIATION MEASURING INSTRUMENTS



OUTSIDE DIAMETER MEASURING INSTRUMENTS



DIGITAL RADIUS GAUGES



DIGITAL ARC RADIUS CALIPERS



DIGITAL RADIUS CALIPERS

PRODUCT INDEX

9

KEYWAY AND CHAMFER MEASURING TOOLS

PAGE 240-244



KEYWAY SYMMETRY GAUGES



KEYWAY SYMMETRY DIGITAL CALIPERS



KEYWAY DEPTH GAUGES



DIGITAL CHAMFER GAUGES



DIGITAL CHAMFER GAUGES

11

INDICATING MEASURING TOOLS

PAGE 299-344



INTERNAL CALIPER GAUGES



EXTERNAL CALIPER GAUGES



THICKNESS GAUGES



RUBBER/GEOMEMBRANE/LEATHER THICKNESS GAUGES



TUBE THICKNESS GAUGES



THREAD/LEAD SCREW PITCH DIAMETER SNAP GAUGES



SNAP GAUGES



STEP AND GAP GAUGES



MINI DIGITAL HEIGHT GAUGES



HEIGHT GAUGES



CRANKSHAFT TESTERS



PERPENDICULARITY COMPARISON GAUGES



THREAD PITCH MEASURING INSTRUMENTS

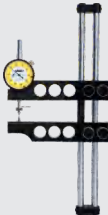

THREAD TAPER MEASURING INSTRUMENTS



THREAD HEIGHT MEASURING INSTRUMENTS



THREAD CREST DIAMETER MEASURING INSTRUMENTS



GROOVE DIAMETER MEASURING INSTRUMENTS

10

INDICATORS AND DIAL INDICATOR STANDS

PAGE 245-298



DIAL TEST INDICATORS



INDICATORS



DIAL TEST INDICATOR HOLDERS



MAGNETIC STANDS



DIAL INDICATOR STANDS (NON-MAGNETIC)



DIAL INDICATOR STANDS

12

STANDARDS AND GAUGE BLOCKS

PAGE 345-408



GAUGE BLOCKS



CALIPER/HEIGHT GAUGE CHECKERS



ANGLE GAUGE BLOCKS



PIN GAUGES



SETTING RINGS



CYLINDER GAUGES



ADJUSTABLE SNAP GAUGES

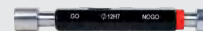

PLAIN PLUG GAUGES



SPLINE RING/PLUG GAUGES



MEASURING BALLS



THREADED HOLE LOCATION GAUGES



THREAD DEPTH GAUGES



THREAD RING/PLUG GAUGES



SEMI-AUTOMATIC THREAD INSPECTORS



EXTERNAL THREAD MEASURING DEVICES

PRODUCT INDEX

13 ANGLE, STRAIGHTNESS, FLATNESS MEASURING TOOLS PAGE 409-426



ANGLE METERS



PROTRACTORS



GRANITE SQUARES



PERPENDICULARITY TESTERS



SQUARES



STRAIGHT EDGES



STRAIGHT EDGES



OPTICAL FLATS

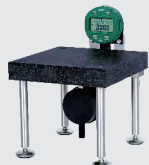

FLATNESS MEASUREMENT STANDS

14 CONCENTRICITY AND RUNOUT TESTERS PAGE 427-441



CONCENTRICITY GAUGES



BENCH CENTERS



EXPANSION MANDRELS

16 SET-UP TOOLS PAGE 487-514



GRANITE SURFACE PLATES



V-BLOCKS

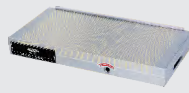

PERMANENT MAGNETIC CHUCKS



PARALLELS



PARALLEL/SQUARE SETS



ANGLE PLATE SETS

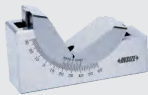

ADJUSTABLE ANGLE BLOCKS

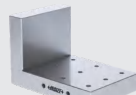

RIGHT ANGLE PLATES



SINE BARS



PRECISION VISES



STAGES

15 SIMPLE MEASURING TOOLS PAGE 442-486



FEELER GAUGES



RADIUS GAUGES



TAPER SLOT GAUGES



TAPER BORE GAUGES



WELDING GAUGES



INSIDE/OUTSIDE CALIPERS



MEASURING TAPES



MEASURING WHEELS



STEEL RULERS



DIGITAL SCALES WITH MICROSCOPE



COMBINATION SQUARES

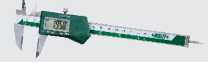

SCRIBING CALIPERS



PRECISION SCREWDRIVER SETS



LED FLASHLIGHTS



MEASURING TOOL SETS

17 ON-MACHINE MEASUREMENT PAGE 515-536



VIDEO MEASURING INSTRUMENT FOR MACHINE TOOLS



CENTERING INDICATORS



EDGE FINDERS



TRIGGER-TYPE 3D PROBES



INFRARED TRANSMISSION PROBES FOR CNC MACHINE TOOLS



VERTICAL MILLING MACHINE PERPENDICULARITY MEASURING GAUGES



ZERO SETTERS WITH CABLE



ZERO SETTERS

PRODUCT INDEX

18 LEVELS

PAGE 537-553



LEVELS



CROSS-LINE
LASER LEVELS



SELF-LEVELING
ROTARY LASERS

19 LINEAR PROBES AND SCALES

PAGE 554-576



LINEAR PROBES



LASER DISPLACEMENT
SENSORS

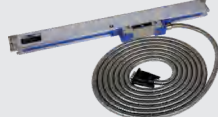

LINEAR SCALES



SCALES

21 CMM

PAGE 606-628



CMM



MEASURING ARMS



STYLI FOR CMM



GAUGE BLOCK STANDS
FOR CMM



CMM
CHECK MASTERS

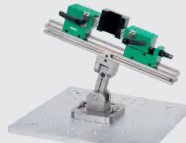

JIGS FOR CMM

23 CUTTING TOOLS INSPECTION

PAGE 675-687



TOOL PRESETTERS



CUTTING TOOLS MICROSCOPES

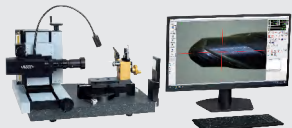

CUTTING TOOLS VISION
MEASURING SYSTEMS



SHANK RUNOUT
TESTERS

20 ROUNDNESS, PROFILE AND ROUGHNESS TESTERS

PAGE 577-605



ROUNDNESS
MEASURING MACHINES



PRECISION AIR
FLOATING
ROTARY TABLES



SURFACE PROFILE
MEASURING MACHINES



ROUGHNESS TESTERS

22 PROFILE PROJECTORS, QUICK MEASUREMENT SYSTEMS, VISION MEASURING SYSTEMS

PAGE 629-674



PROFILE
PROJECTORS

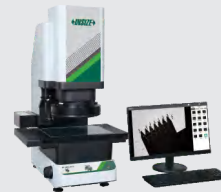

QUICK MEASUREMENT
SYSTEMS



VISION MEASURING
SYSTEMS

24 MICROSCOPES, MAGNIFIERS

PAGE 688-772



TOOLMAKER MICROSCOPES



DIGITAL MICROSCOPES



MICROSCOPES



MAGNIFIERS



TELESCOPING
INSPECTION MIRRORS

25 VIDEOSCOPIES

PAGE 773-792



VIDEOSCOPIES



RIGID BORESCOPIES

PRODUCT INDEX

26 VARIOUS INSTRUMENTS PAGE 793-816



AIR LEAKAGE TESTERS



AIR GAUGES AND DISPLAYS



DIGITAL GAP GAUGES



LASER SCAN MICROMETERS



LENGTH MEASURING MACHINES



TOTAL STATIONS



INDUSTRIAL ACOUSTIC IMAGERS



AUTOMATIC CLEANLINESS ANALYSIS SYSTEMS



AUTOMATIC VISION INSPECTION MACHINES



THREE-DIMENSION FULL-FIELD STRAIN MEASUREMENT SYSTEMS



LARGE FIELD OF VIEW DYNAMIC MEASUREMENT SYSTEMS

27 HARDNESS TESTERS PAGE 817-877



HARDNESS TESTERS



CONCRETE STRENGTH TESTERS

28 METALLOGRAPHY PREPARATION PAGE 878-896



CUTTING MACHINES



GRINDERS AND POLISHERS



MOUNTING PRESSES

29 FLAW DETECTORS PAGE 897-913



PORTABLE EDDY CURRENT FLAW DETECTORS



ULTRASONIC FLAW DETECTORS



PORTABLE MAGNETIC POWDER FLAW DETECTORS



FLUORESCENT MAGNETIC POWDER FLAW DETECTORS



UV FLAW DETECTION LIGHTS



WIRE ROPE FLAW DETECTORS

31 TESTING MACHINES, FORCE GAUGES, TENSION METERS PAGE 945-985



UNIVERSAL TESTING MACHINES

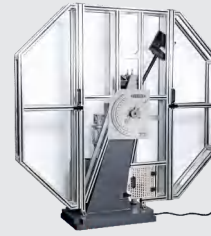

IMPACT TESTING MACHINES



FRICTION AND WEAR TESTING MACHINES



FRICTION/PEEL TESTERS



PNEUMATIC KEY LIFE TESTERS



TENSILE AND COMPRESSION TESTING MACHINES



DIGITAL SPRING TESTERS



FORCE GAUGES



TENSILE/COMPRESSION SENSORS



DIAL TENSION GAUGES



WIRE TENSION METERS



SPINDLE TENSION METERS

PRODUCT INDEX

30 COMPONENT ANALYSIS PAGE 914-944



SPECTROMETERS



FOURIER TRANSFORM INFRARED SPECTROMETERS



CARBON AND SULFUR ANALYZERS



GAS CHROMATOGRAPHIES



LIQUID CHROMATOGRAPHIES

33 COATING INSPECTION PAGE 1038-1069



COATING THICKNESS GAUGES



SURFACE PROFILE GAUGES



GLOSS METERS



HOLIDAY DETECTORS



SPECTROPHOTOMETERS



DIGITAL ADHESION TESTERS



PENCIL HARDNESS TESTERS



ROTATIONAL ABRASION TESTERS



CROSS CUT ADHESION TESTERS



CONICAL MANDREL TEST APPARATUS



PAINT FILM FLEXIBILITY TESTERS



IMPACT TESTERS

32 TORQUE TESTERS, TORQUE WRENCHES PAGE 986-1037



TORSION TESTING MACHINES



TORQUE TESTERS



TORQUE SENSORS



HANDHELD FORCE/TORQUE INDICATORS



TORQUE SCREWDRIVERS



ELECTRIC SCREWDRIVERS



DESKTOP AUTOMATIC TIGHTENING MACHINES



TORQUE WRENCHES



TORQUE ADAPTERS



TORQUE MULTIPLIERS

35 ENVIRONMENT TESTING PAGE 1104-1135



INFRARED THERMAL IMAGING CAMERAS



INFRARED THERMOMETERS



THERMOHYGRO METERS



DIFFERENTIAL PRESSURE MANOMETERS



ANEMOMETERS



HOT WIRE ANEMOMETERS



SOUND LEVEL METERS



LIGHT METERS

PRODUCT INDEX

34 PORTABLE INSTRUMENTS

PAGE 1070-1103



ELECTROMAGNETIC
ULTRASONIC
THICKNESS GAUGES



ULTRASONIC
THICKNESS GAUGES



TACHOMETERS



STROBOSCOPES



VIBRATION METERS



LASER DISTANCE
METERS



STROKE COUNTERS



DIGITAL
STOPWATCHES



DIGITAL MOISTURE
METERS



PRESSURE GAUGE
CALIBRATION PUMPS



PRESSURE
GAUGES



EDDY CURRENT
CONDUCTIVITY TESTERS



TESLAMETERS



LIGHT TRANSMITTANCE
METERS



DIGITAL GLASS
THICKNESS METERS

36 LIQUID AND GAS TESTING

PAGE 1136-1151



CONDUCTIVITY/TDS/
SALINITY/pH TESTERS



WATER QUALITY
TESTERS



REFRACTOMETERS



HANDHELD AIRBORNE
PARTICLE COUNTERS



DRY LASER PARTICLE
SIZE ANALYZERS



OPACIMETERS

37 SCALES

PAGE 1152-1185



SCALES



WEIGHTS

38 RELIABILITY TESTING

PAGE 1186-1192



SALT SPRAY
TEST CHAMBERS



TEMPERATURE AND
HUMIDITY CHAMBERS



ELECTRODYNAMIC
VIBRATION SYSTEMS

39 ELECTRONIC TESTING

PAGE 1193-1215

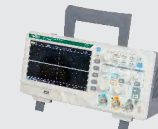

DIGITAL
OSCILLOSCOPES



AC/DC DIGITAL
POWER METERS



DC RESISTANCE
TESTERS



LCR METERS



AC/DC WITHSTANDING
VOLTAGE INSULATION
TESTERS



INSULATION
RESISTANCE
TESTERS



DC POWER SUPPLIES



DIGITAL MULTIMETERS



DIGITAL AC/DC
CLAMP METERS



VOLTAGE TESTERS



SOLDERING IRONS

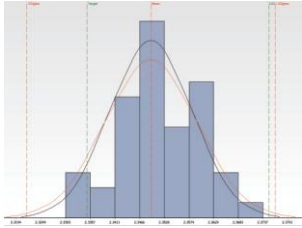

Data Management Softwares
Page 2-4



Wireless Data Transmission Systems
Page 5-15



Data Output Cables
Page 16-27



Mobile Workbenches
Page 27

MEASUREMENT DATA MANAGEMENT AND ANALYSIS SOFTWARE

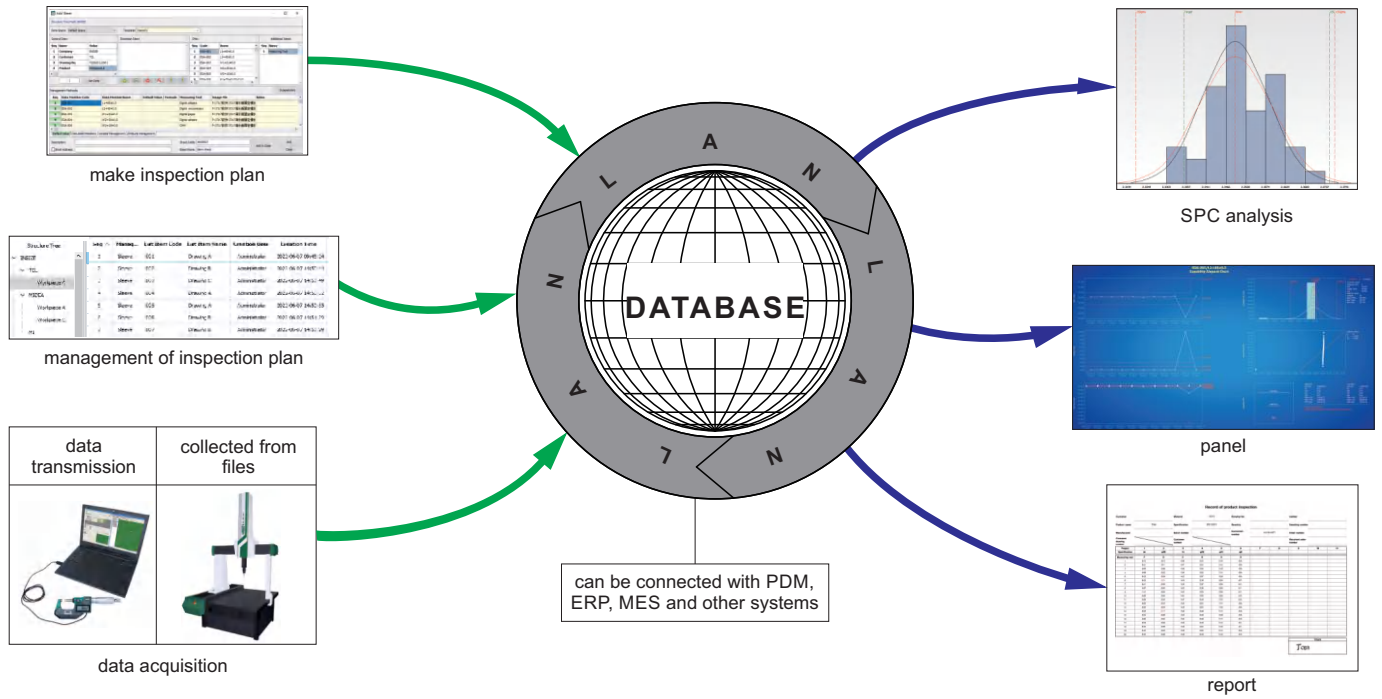

Make inspection plan

- Define the dimensions, tolerances, control range and other parameters of workpieces



define the drawing of workpieces

- define association items of data
- define the measured dimension and tolerance

Seq	Data Member Code	Data Member Name	Measuring Tool	1	2	3	4	5	6
1	DC04070001	Check type							
2	DC04070002	Serial number							
3	DC04070003	Furnace No.							
4	DC02070001	Fitness ± 0.008	CHH						
5	DC02070002	Verticality $\pm 0.01 / -0.03$	Vernier caliper						
6	DC02070003	Verticality ± 0.008	CHH						
7	DC02070004	2.335 ± 0.004	Vernier caliper						
8	DC02070005	Outside diameter $\Phi = 45 \pm 0.002$	Micrometer						
9	DC02070006	Inner diameter $\Phi = 45 \pm 0.002$	Micrometer						
10	DC02070007	Wall thickness							

Management of inspection plan

Seq	Manag...	List Item Code	List Item Name	Creation User	Creation Time
1	Sleeve	001	Drawing A	Administrator	2022-06-07 09:45:24
2	Sleeve	002	Drawing B	Administrator	2022-06-07 14:50:44
3	Sleeve	003	Drawing C	Administrator	2022-06-07 14:50:49
4	Sleeve	004	Drawing A	Administrator	2022-06-07 14:50:52
5	Sleeve	005	Drawing A	Administrator	2022-06-07 14:50:55
6	Sleeve	006	Drawing B	Administrator	2022-06-07 14:51:29
7	Sleeve	007	Drawing B	Administrator	2022-06-07 14:50:29

management by customers

```

INSIZE.COM
├── Drawing
│   ├── A0103
│   │   ├── A010301
│   │   └── A010302
│   ├── A0104
│   │   ├── A0104011
│   │   └── A0104014
│   └── B2467
│       └── B246798
    
```

management by drawings

```

INSIZE.CN
├── Production department
│   ├── Production area 1
│   │   └── Workpiece C
│   ├── Production area 2
│   │   └── Workpiece D
│   └── Production area 3
    
```

management by departments

To be continued

Continued from previous page

Data acquisition

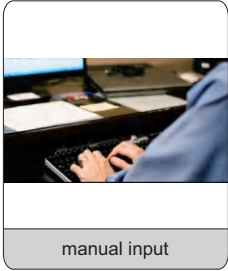

manual input

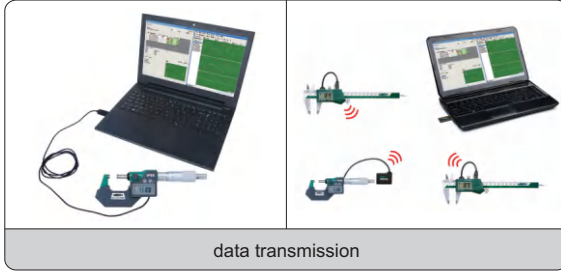

data transmission



file parsing



screen capture

Measurement data management and analysis software(Standalone Edition) - Version: 8.0 / Build: 2021.08.11.1(Evaluation Version)

<< Back Add Record +N Report View Report Print Data Analysis

By Day By Week **By Month** By Quarter By Year Data ↓

By Time Period: 2022-06-01 0:00:00 To 2022-07-01 23:59:59 Refresh Cursor ↓

Seq	Data Member Code	Data Member Name	Measuring Tool	1	2	3	4	5
				2022-06-08 10:58:07	2022-06-08 10:58:07	2022-06-08 10:58:08	2022-06-08 11:03:40	2022-06-08 11:10:40
1	DC04070001	Check type		First inspection	First inspection	Process inspection	Process inspection	Process inspection
2	DC04070002	Serial number		20220608001	20220608001	20220608001	20220608002	20220608002
3	DC04070003	Furnace No.		F00120	F00120	F00120	F00120	F00120
4	DC02070001	Flatness0.008	CFH	0.0080	0.0080	0.0080	0.0082	
5	DC02070002	2.39+0.01/-0.03	Vernier caliper	2.391	2.391	2.391	2.410	
6	DC02070003	Verticality0.008	CFH	0.0080	0.0080	0.0080	0.0080	
7	DC02070004	2.335±0.004	Vernier caliper	2.3350	2.3350	2.3350	2.3350	
8	DC02070005	Outside diameterφ=45±0.002	Micrometer	45.0020	45.0030	45.0020	44.9977	
9	DC02070006	Inner diameterφ=45±0.002	Micrometer	45.0010	45.0010	45.0010	45.0010	
10	DC02070007	Wall thickness		0.0010	0.0020	0.0010	-0.0033	
		Input User		Administrator	Administrator	Administrator	Administrator	Administrator

001(Drawing A)

M. Template Code: MTC-0-0016 M. Template Name: Sleeve M. Item Code: 001 M. Item Name: Drawing A

Other Related Info: INSIZE -> TCL -> Workpiece A

Enable Serial Port Data ID: All No Auto Match Auto Match By Data ID Auto Match By Specification Auto Switch Record

Enable Data File Import Rule: Workpiece A C:\Users\INSIZE-ENGINEER\Desktop\7317 Data import for workpiece A.xlsx Import

measurement interface

SPC

- Provide variety of quality analysis control charts



Xbar-R control chart



I-MR control chart



run control chart

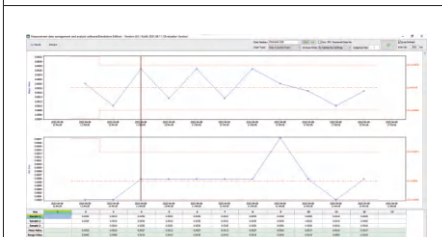

Xbar-S control chart

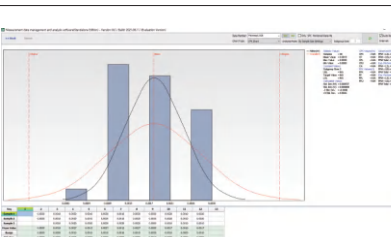

CPK control chart

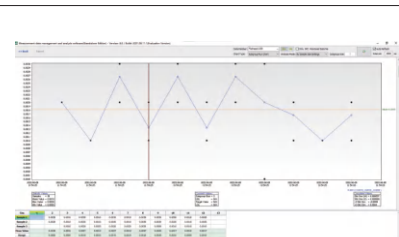

subgroup run chart

To be continued

Continued from previous page

Panel

- Real-time display of SPC charts of multiple dimensions on the panel to monitor production quality

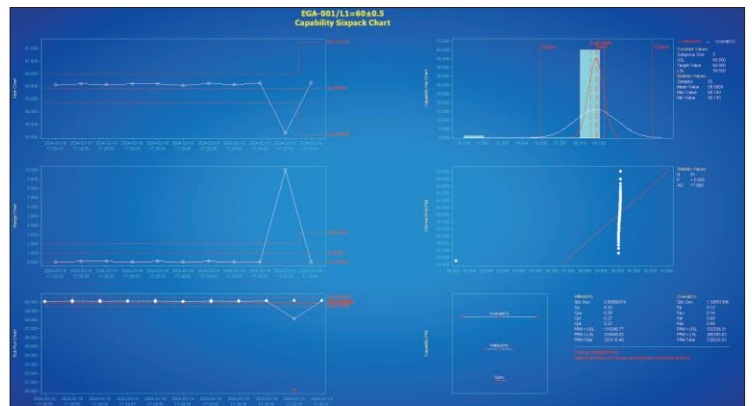

Report

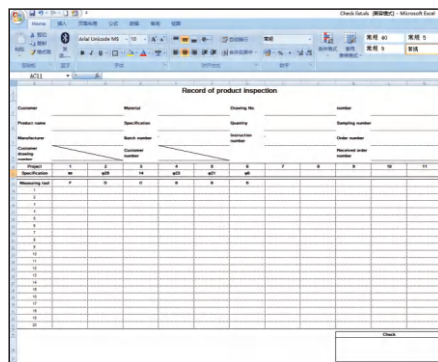

report template

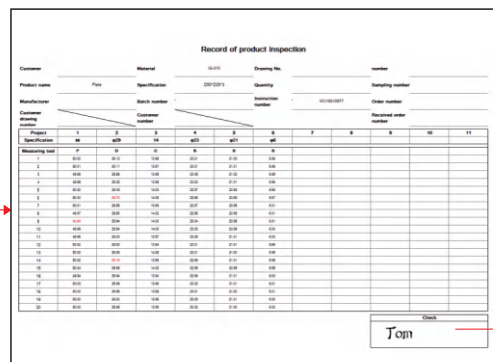

generate report

support exporting electronic signature

Complete version

Code	Data acquisition			SPC data analysis	Quality report	Real-time panel
	Manual input + Data transmission	File parsing	Screen capture			
7317	✓	✓	✓	✓	✓	✓

Acquisition+Analyze+Report

Code	Data acquisition		SPC data analysis	Quality report
	Manual input + Data transmission	File parsing		
7317-A1	✓		✓	✓
7317-A2		✓	✓	✓

Acquisition+Analyze

Code	Data acquisition		SPC data analysis
	Manual input + Data transmission	File parsing	
7317-B1	✓		✓
7317-B2		✓	✓

Acquisition+Report

Code	Data acquisition		Quality report
	Manual input + Data transmission	File parsing	
7317-C1	✓		✓
7317-C2		✓	✓

Acquisition

Code	Data acquisition	
	Manual input + Data transmission	File parsing
7317-D1	✓	
7317-D2		✓

Panel

Code	Real-time panel
7317-P	✓

WIRELESS DATA TRANSMISSION SYSTEM (ZIGBEE)



- Through wireless transmission, the readings of measuring tools can be transmitted to computers or mobile phone
- Wireless zigbee protocol, conforming to IEEE802, 2.4GHz band
- Transmission distance is 15 meter (under the condition of no obstruction and no electromagnetic interference)

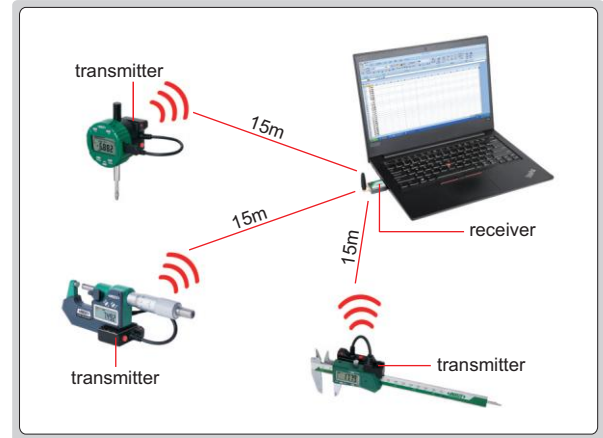

Transmitter

- Connecting to digital measuring tools such as calipers, micrometers and indicators
- CR2032 battery

Code	Description	Transmitter	Connecting with measuring tool	Transmit data
7315-25	transmitter for digital calipers			<ul style="list-style-type: none"> Press the button of the transmitter Data is transmitted once, the signal light of the transmitter flashes once
7315-22	transmitter for large digital calipers			<ul style="list-style-type: none"> Press the button of the transmitter Data is transmitted once, the signal light of the transmitter flashes once
7315-30	transmitter for digital micrometers		 for 3102, 3128, 3565 series digital micrometers	<ul style="list-style-type: none"> Press the "data" button of digital micrometer, can also press the button of the transmitter Data is transmitted once, the signal light of the transmitter flashes once, at the same time, the signal light on the digital micrometer flashes once









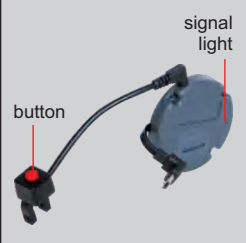
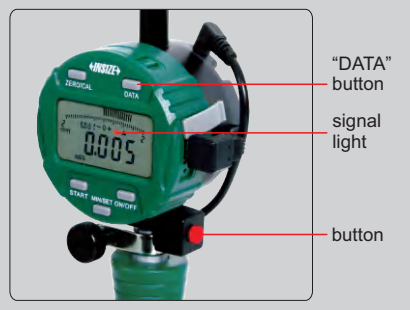
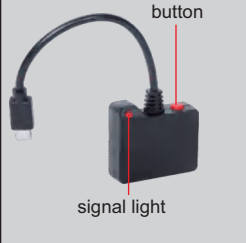

To be continued

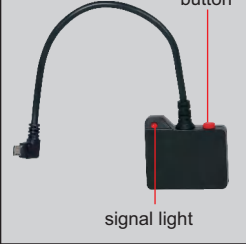
Continued from previous page

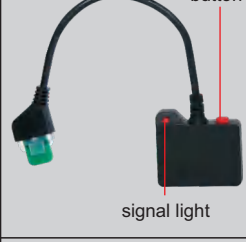
Code	Description	Transmitter	Connecting with measuring tool	Transmit data
7315-31	transmitter for digital micrometers		<p>“data” button</p> <p>signal light</p> <p>back</p>	<ul style="list-style-type: none"> Press the “data” button of digital micrometer Data is transmitted once, the signal light on the digital micrometer flashes once
7315-50M	transmitter for digital indicators	<p>button</p> <p>signal light</p>	<p>signal light</p> <p>button</p>	<ul style="list-style-type: none"> Press the button of the transmitter Data is transmitted once, the signal light of the transmitter flashes once
7315-51	transmitter for digital indicators	<p>button</p> <p>signal light</p>	<p>“DATA” button</p> <p>signal light</p> <p>button</p> <p>for 2108, 2138, 2139 series digital indicators</p> <p>signal light</p> <p>foot switch (code 7304-7, optional)</p> <p>back</p>	<ul style="list-style-type: none"> Press the “DATA” button of digital indicator, can also press the button of the transmitter Transmitter button can be fixed on request Data is transmitted once, the signal light on digital indicator flashes once
			<p>button</p> <p>for other digital indicators</p> <p>signal light</p> <p>foot switch (code 7304-7, optional)</p> <p>back</p>	<ul style="list-style-type: none"> Press the button of the transmitter Transmitter button can be fixed on request Data is transmitted once, the signal light on digital indicator flashes once

To be continued

Continued from previous page

Code	Description	Transmitter	Connecting with measuring tool	Transmit data
7315-51B	transmitter for bore gauges			<ul style="list-style-type: none"> Press the "DATA" button of digital indicator, can also press the button of the transmitter Data is transmitted once, the signal light on digital indicator flashes once
7315-2183	transmitter for digital indicators			<ul style="list-style-type: none"> Press the button of the transmitter Data is transmitted once, the signal light of the transmitter flashes once
7315-60	transmitter for high precision digital indicators			<ul style="list-style-type: none"> Press the button of the transmitter Data is transmitted once, the signal light of the transmitter flashes once
7315-80	transmitter for digital calipers/micrometers			<ul style="list-style-type: none"> Press the "SET" button of the calipers/micrometers, can also press the button of the transmitter Data is transmitted once, the signal light of the transmitter flashes once
7315-3350	transmitter for digital micrometers			<ul style="list-style-type: none"> Press the button of the transmitter Data is transmitted once, the signal light of the transmitter flashes once
7315-1150	transmitter for digital height gauges			<ul style="list-style-type: none"> Press the button of the transmitter Data is transmitted once, the signal light of the transmitter flashes once

To be continued

Continued from previous page





Code	Description	Transmitter	Connecting with measuring tool	Transmit data
7315-1151	transmitter for digital height gauges			<ul style="list-style-type: none"> Press the button of the transmitter Data is transmitted once, the signal light of the transmitter flashes once
7315-2172	transmitter for digital protractors			<ul style="list-style-type: none"> Press the button of the transmitter Data is transmitted once, the signal light of the transmitter flashes once
7315-2771	transmitter for digital protractors			<ul style="list-style-type: none"> Press the button of the transmitter Data is transmitted once, the signal light of the transmitter flashes once
7315-8001	transmitter for electronic balances		 <p>for 8001-6D, 8001-15D, 8001-30D series weighing scales and 8501 series platform scales</p>	<ul style="list-style-type: none"> Press the button of the transmitter Data is transmitted once, the signal light of the transmitter flashes once
7315-8301	transmitter for electronic balances		 	<ul style="list-style-type: none"> Press the "0.00" button of the electronic balances, can also press the button of the transmitter Data is transmitted once, the signal light of the transmitter flashes once

To be continued

Continued from previous page

Receiver (keyboard signal)

- For computers and mobile phones
- Recognized as HID keyboard device, the transmitted data is recognized by computers or mobile phones as keyboard input data and press enter key, such as 12.34↵. No need to install drivers and softwares
- Data can be transmitted to excel, word, txt etc.
- For any softwares which can receive keyboard signal

Code	Product	Description	Remark
7315-3	 <p>USB port</p>	single channel receiver	connected with 1 transmitter only
7315-6	 <p>USB port</p>	multichannel receiver	connected with 6 transmitters, each channel has status indicator
7315-7	 <p>type-C port</p>		
7315-8	 <p>micro USB port</p>		
7315-9	 <p>lightning port</p>		

Receiver (text format, virtual com port)

- For computers with windows system
- Text format virtual com port, converted to keyboard format with supplied software
- Supplied with Excel directional input software
- Measurement data can be transmitted to excel, word, txt etc. and any software which receives keyboard signal

Code	Product	Description	Remark
7315-2	 <p>USB port</p> <p>antenna</p>	multichannel receiver	connected with maximum 16 transmitters, each of them has unique identification code

To be continued

Continued from previous page

Receiver (485 communication)

- Modbus-RTU protocols , baud rate 9600
- Can be connected to a PC or PLC
- The communication address is configurable

Code	Product	Description	Remark
7315-485		multichannel receiver	connected with 6 transmitters, each channel has status indicator

Excel directional input software

- Supplied with 7315-2 receiver
- The readings of measuring tools can be transmitted to the designated area of excel, which facilitates data management and improves efficiency

Excel directional input software (included in 7315-2), application example 1

Set the display area of caliper at B4-B9, the readings of caliper are displayed at B4, B5...B9.
 Set the display area of micrometer at C4-C9, the readings of micrometer are displayed at C4, C5... C9.
 Set the display area of height gauge at D4-D9, the readings of height gauge are displayed at D4, D5... D9.

	A	B	C	D
1	Project	Length	Width	Height
2	Dimension and Tolerance	50±0.05	24±0.01	10+0.05/-0.06
3	Measuring tool	Caliper	Micrometer	Height gage
4	1	50.02	24.004	9.98
5	2	50.01	24.010	10.01
6	3	49.99	23.990	10.02
7	4	50.00	23.996	9.99
8	5	50.04	24.000	10.01
9	6	Channel 1	Channel 2	Channel 3

serial of workpieces the next data display area is indicated in green

Excel directional input software (included in 7315-2), application example 2

Set the display area of micrometer at B4-C9, data input is from the left to the right, the readings of micrometer are displayed at B4, C4, B5, C5... B9, C9.
 Set the display area of caliper at D4-D9, the readings of caliper are displayed at D4, D5... D9.
 Set the display area of depth gauge at E4-E9, the readings of depth gauge are displayed at E4, E5... E9.

	A	B	C	D	E
1	Project	External diameter1	External diameter2	Length	Depth
2	Dimension and Tolerance	Φ23+0.01/-0.02	Φ21+0.01/-0.02	50±0.04	28±0.05
3	Measuring tool	Micrometer	Micrometer	Caliper	Depth gage
4	1	23.010	21.008	49.98	28.01
5	2	23.010	21.000	49.98	27.98
6	3	22.999	21.000	50	28
7	4	23.007	20.998	50	28
8	5	23.000	20.985	50.01	28.01
9	6	23.008	Channel 1	Channel 2	Channel 3

serial of workpieces the next data display area is indicated in green

BLUETOOTH TRANSMITTERS



- Through bluetooth transmission, the readings of measuring tools can be transmitted to computers or mobile phones
- 2.4GHz band
- Recognized as HID keyboard device, the transmitted data is recognized by computers or mobile phones as keyboard input data and press enter key, such as 12.34 ↵
- No need to install drivers and softwares, data can be transmitted to excel, word, txt etc.
- For any softwares which can receive keyboard signal
- Transmission distance is 10 meter (under the condition of no obstruction and no electromagnetic interference)
- Connecting to digital measuring tools such as calipers, micrometers and indicators
- CR2032 battery

connecting with computer

connecting with mobile phone

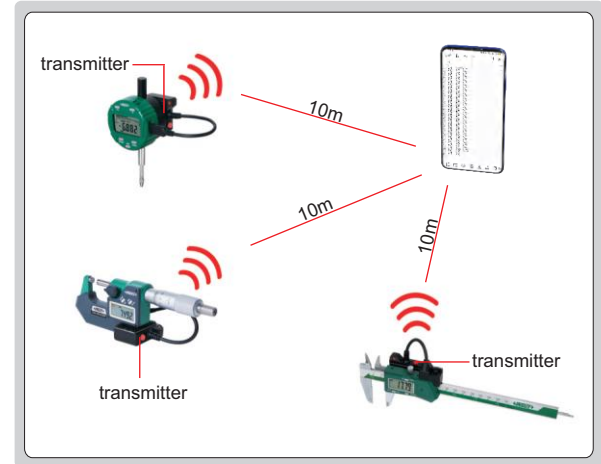
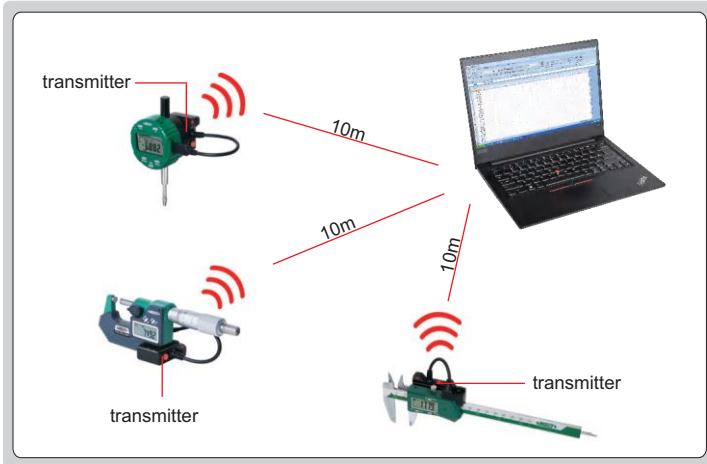

Code	Description	Transmitter	Connecting with measuring tool	Transmit data
7214-25	transmitter for digital calipers			<ul style="list-style-type: none"> ■ Press the button of the transmitter ■ Data is transmitted once, the signal light of the transmitter flashes once
7214-22	transmitter for large digital calipers			<ul style="list-style-type: none"> ■ Press the button of the transmitter ■ Data is transmitted once, the signal light of the transmitter flashes once
7214-30	transmitter for digital micrometers		 for 3102, 3128, 3565 series digital micrometers	<ul style="list-style-type: none"> ■ Press the "data" button of the digital micrometer, can also press the button of the transmitter ■ Data is transmitted once, the signal light of the transmitted flashes once, at the same time, the signal light on the digital micrometer flashes once

To be continued

Continued from previous page

Code	Description	Transmitter	Connecting with measuring tool	Transmit data
7214-31	transmitter for digital micrometers		<p>“data” button</p> <p>signal light</p> <p>back</p>	<ul style="list-style-type: none"> Press the “data” button of digital micrometer Data is transmitted once, the signal light on the digital micrometer flashes once
7214-50M	transmitter for digital indicators	<p>button</p> <p>signal light</p>	<p>signal light</p> <p>button</p> <p>for digital indicators without data button</p>	<ul style="list-style-type: none"> Press the button of the transmitter Data is transmitted once, the signal light of the transmitter flashes once
7214-51	transmitter for digital indicators	<p>signal light</p> <p>button</p>	<p>“DATA” button</p> <p>signal light</p> <p>button</p> <p>for digital indicators with data button</p> <p>signal light</p> <p>foot switch (code 7304-7, optional)</p> <p>back</p>	<ul style="list-style-type: none"> Press the “DATA” button of digital indicator, can also press the button of the transmitter Transmitter button can be fixed on request Data is transmitted once, the signal light on digital indicator flashes once
7214-51B	transmitter for bore gauges	<p>button</p> <p>signal light</p>	<p>“DATA” button</p> <p>signal light</p> <p>button</p> <p>for bore gauges with data button</p>	<ul style="list-style-type: none"> Press the “DATA” button of digital indicator, can also press the button of the transmitter Data is transmitted once, the signal light on digital indicator flashes once

WIRELESS DATA TRANSMISSION SYSTEM OF DIGITAL INDICATORS (REMOTE CONTROL)



- The readings of digital indicators can be transmitted to computers or mobile phones
- Data acquisition can be remotely controlled through the receiver
- Wireless zigbee protocol, conforming to IEEE802, 2.4GHz band
- Transmission distance is 15 meter (under the condition of no obstruction and no electromagnetic interference)

transmission method: the button on receiver is pressed once, the readings of all digital indicators are transmitted

	channel 1	channel 2	channel 3	channel 4	channel 5	channel 6
	A	B	C	D	E	F
1	24.35	0.4045	57.72	1.949	0.4075	0.03568
2	24.45	0.5045	57.82	2.049	0.5075	0.13568
3	26.35	0.4045	57.72	1.949	0.4075	0.00078
4	27.35	0.4045	57.72	1.7575	0.4075	0.0762
5	28.35	0.4045	57.72	1.7575	0.4075	0.0762
6	29.35	0.4045	57.72	1.7575	0.4075	0.07618
7	30.35	0.4045	57.72	1.7575	0.4075	0.55334
8	31.35	0.4045	57.72	1.7575	0.4075	0.61198
9	24.35	0.4045	57.72	1.7575	0.4075	0.6172

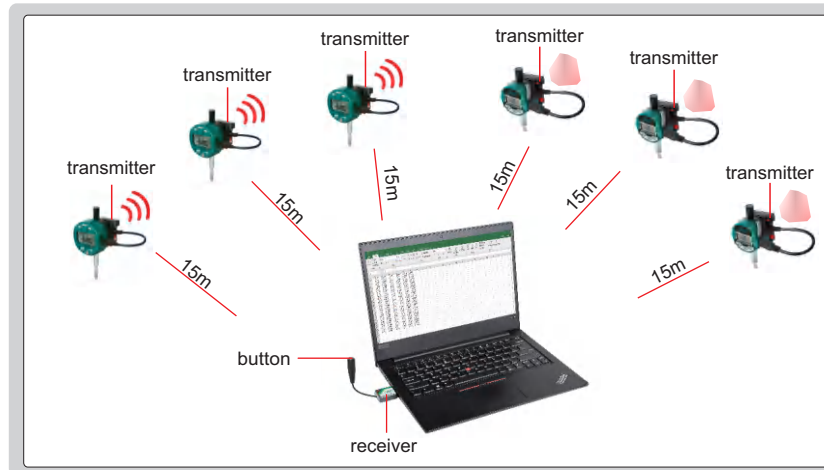

Transmitter

- Suitable for digital indicators
- CR2032 battery
- 80 hours of operation on a single battery in measurement mode





Code	Transmitter	Connecting with digital indicators	Transmit data
7213-56			<ul style="list-style-type: none"> ▪ Press and hold the button to enter the measurement mode ▪ Press the receiver button in measurement mode to acquire data

To be continued

Continued from previous page

Receiver (keyboard signal)

- For computers and mobile phones
- Recognized as HID keyboard device, the transmitted data is recognized by computers or mobile phones as keyboard input data and press enter key, such as 12.345.
- No need to install drivers and softwares
- Data can be transmitted to excel, word, txt etc.
- Suitable for any softwares which can receive keyboard signal

Code	Product	Description	Remark	Transmit data
7213-6M		multichannel receiver	connected with 6 transmitter, each channel has status indicator	<ul style="list-style-type: none"> ▪ Press the button of the receiver ▪ Data is transmitted once, the signal light of the receiver flashes once
7213-7M				
7213-8M				
7213-9M				

hand switch, code **7213-SW** (included), length 2m



COMPARISON TABLE

ZIGBEE Wireless Transmission

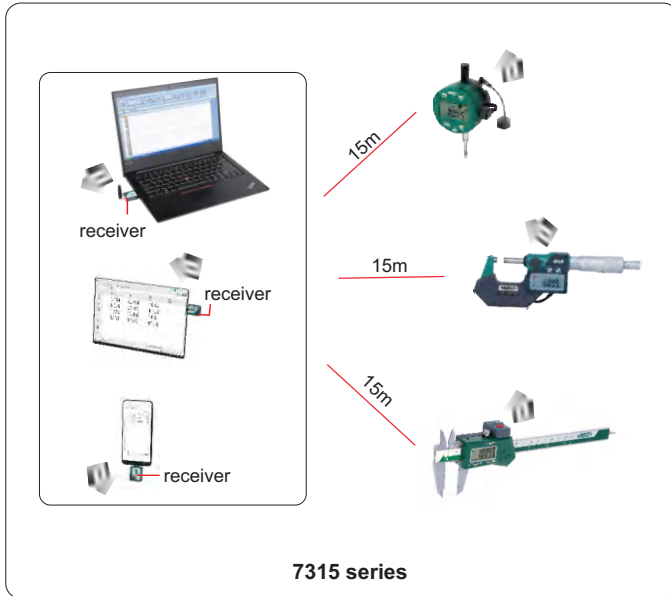

Bluetooth Wireless Transmission

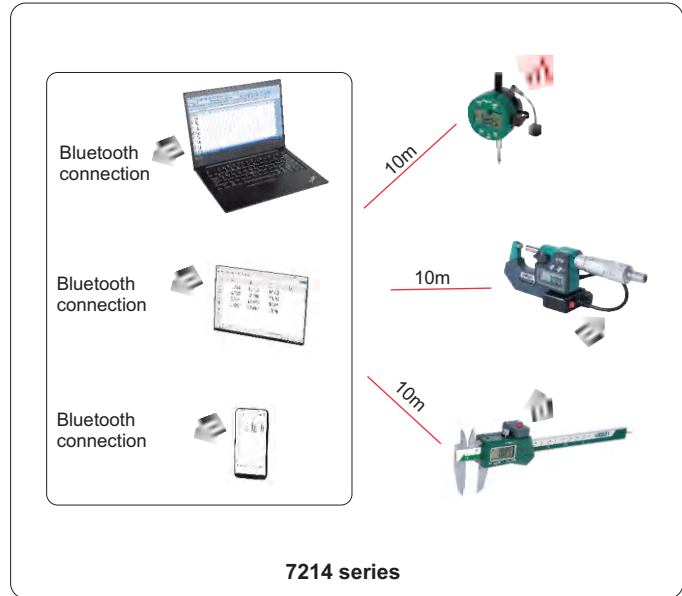

Code	7315 series	7214 series
Function	wireless transmission of measurement data from measuring tools to computers or mobile phones	
Operation system	Windows, Android or iOS	
Wireless module	Zigbee	Bluetooth 5.0
Receiver	need receiver (one receiver can be connected to 16 transmitters)	receiver is not needed, Bluetooth connection (one computer/mobile phone can be connected to 7 transmitters)
Communication type	<p>keyboard format (suitable for any software or APP which can receive keyboard input values)</p> <p>text format, virtual com port (a. connect to software which recognizes different channels and IDs according to serial communication protocols and defines data entry area for different measurement tools; b. can also use the software (included in the 7315-2 receiver) to transmit measurement data from multiple measuring tools to the designated area in Excel for easy data management)</p>	<p>keyboard format (suitable for any software or APP which can receive keyboard input values)</p>
Acquisition method	press-button single transmission	
Transmission performance	transmission performance with low power consumption, high speed, accurate and stable data, and strong anti-interference performance	transmission performance depends on the Bluetooth performance of computers/mobile phones
Transmission distance	15m	10m
Connection memory	matching operation is not needed after the computer/mobile phone is turned off and on again	need to press the button to match after the computer/mobile phone is turned off and on again

DATA OUTPUT CABLES (TEXT FORMAT, VIRTUAL COM PORT)

1) Data output cables with transmit box

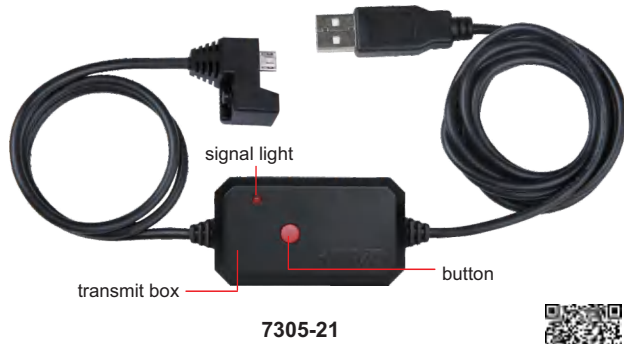

7305-21

Single transmit (can be switched to continuous transmit)





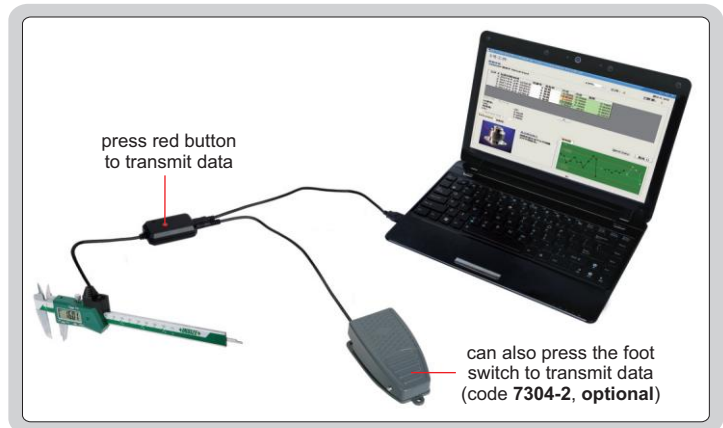





application



Code	Description	Plug to measuring tool	Plug to computer	Connecting with measuring tool	Transmit data
7305-21	cable for digital calipers (length 3m)				<ul style="list-style-type: none"> Press the button on the plug of cable, can also press the button of the transmit box, or press the foot switch Data is transmitted once, the signal light of the transmit box flashes once
7305-R21					
7305-22	cable for large digital calipers (length 2.5m)				<ul style="list-style-type: none"> Press the button of the transmit box, or press the foot switch Data is transmitted once, the signal light of the transmit box flashes once
7305-R22					
7305-30	cable for digital micrometers (length 2.5m)				<ul style="list-style-type: none"> Press the "data" button of digital micrometer, can also press the button of the transmit box, or press the foot switch Data is transmitted once, the signal light of the transmit box flashes once, at the same time, the signal light on the digital micrometer flashes once
7305-R30					
7305-31	cable for digital micrometers (length 2.5m)				<ul style="list-style-type: none"> Press the "data" button of digital micrometer, can also press the button of the transmit box, or press the foot switch Data is transmitted once, the signal light of the transmit box flashes once, at the same time, the signal light on the digital micrometer flashes once
7305-R31					

To be continued



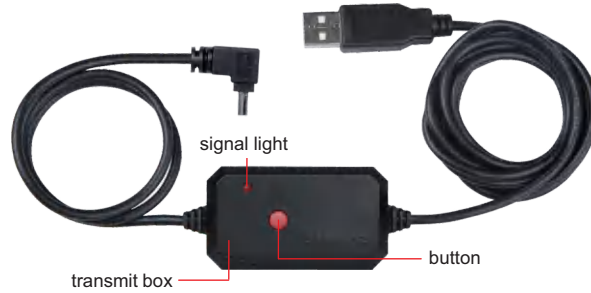

Continued from previous page

Code	Description	Plug to measuring tool	Plug to computer	Connecting with measuring tool	Transmit data
7305-50M	cable for digital gauges (length 2.5m)				<ul style="list-style-type: none"> Press the button of the transmit box, or press the foot switch Data is transmitted once, the signal light of the transmit box flashes once
7305-R50M					
7305-1150	cable for digital height gauges (length 2.5m)				<ul style="list-style-type: none"> Press the button of the transmit box, or press the foot switch Data is transmitted once, the signal light of the transmit box flashes once
7305-R1150					



7305-40M

Continuous transmit (can be switched to single transmit)

Code	Description	Plug to measuring tool	Plug to computer	Connecting with measuring tool	Transmit data
7305-40M	cable for digital indicators (length 2.5m)			 <p>for 2108, 2138, 2139 series digital indicators</p>	<p>Continuous transmit is controlled in software</p> <p>Single transmit:</p> <ul style="list-style-type: none"> Press the "DATA" button of digital indicator, can also press the button of the transmit box, or press the foot switch Data is transmitted once, the signal light of the transmit box flashes once, at the same time, the signal light on digital indicator flashes once <p>Note: long press button to zero the digital indicators; software of data transmit is included</p>
				 <p>for other digital indicators</p>	<p>Continuous transmit is controlled in software</p> <p>Single transmit:</p> <ul style="list-style-type: none"> Press the button of the transmit box, or press the foot switch Data is transmitted once, the signal light of the transmit box flashes once <p>Note: long press button to zero the digital indicators; software of data transmit is included</p>

To be continued

Continued from previous page

Code	Description	Plug to measuring tool	Plug to computer	Connecting with measuring tool	Transmit data
7305-R40M	cable for digital indicators (length 2.5m)			<p>for 2108, 2138, 2139 series digital indicators</p>	<p>Continuous transmit is controlled in software</p> <p>Single transmit:</p> <ul style="list-style-type: none"> Press the "DATA" button of digital indicator, can also press the button of the transmit box, or press the foot switch Data is transmitted once, the signal light of the transmit box flashes once, at the same time, the signal light on digital indicator flashes once <p>Note: long press button to zero the digital indicators; software of data transmit is included</p>
				<p>for other digital indicators</p>	<p>Continuous transmit is controlled in software</p> <p>Single transmit:</p> <ul style="list-style-type: none"> Press the button of the transmit box, or press the foot switch Data is transmitted once, the signal light of the transmit box flashes once <p>Note: long press button to zero the digital indicators; software of data transmit is included</p>

Software (included in 7305-40M and 7305-R40M)

- Real-time display
- Tolerance setting, automatic judgment, out-of-tolerance alarm
- Real time statistics: max, min, average, Go/No-Go number
- Can save results as Excel

The screenshot shows the software interface with several key features highlighted by red boxes and labels:

- export Excel:** Points to the 'Save' button in the top control bar.
- real-time display:** Points to the large digital display showing '12.000 mm'.
- setting zero of digital indicators:** Points to the 'Zero' button in the 'Real-time measurement' section.
- measurement results and judgment:** Points to the 'Data collection' table.
- setting tolerance and sampling period:** Points to the 'Parameters' section.

No	Value	Error	Result	Time
000001	11.756	-0.244	OK	2020-10-12 09:28:46
000002	11.730	-0.270	OK	2020-10-12 09:28:47
000003	10.940	-1.060	NG	2020-10-12 09:28:48
000004	10.120	-1.880	NG	2020-10-12 09:28:50
000005	12.000	0.000	OK	2020-10-12 09:28:52
000006	12.000	0.000	OK	2020-10-12 09:28:53
000007	11.490	-0.510	OK	2020-10-12 09:28:54
000008	10.784	-1.216	NG	2020-10-12 09:28:55
000009	10.030	-1.970	NG	2020-10-12 09:28:56
000010	10.600	-1.400	NG	2020-10-12 09:28:58

To be continued

Continued from previous page

communication protocol

- Baud: 9600bps
Data bit: 8
Stop bit 1
Check bit: None
No flow control

▪ Data output format

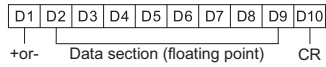

Data format example

Display	Output
1.234	➔ +0001.234 ✓
-1.234	➔ -0001.234 ✓

▪ Data output format with ID number

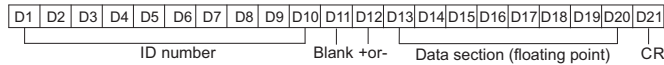

Data format example

Display	Output
1.234	➔ 4109210605 +0001.234 ✓
-1.234	➔ 4109210605 -0001.234 ✓

- The data transmission mode can be switched: single or continuous;
The data output format can be switched: with ID number or without ID number;
Data can be transmitted by command;
The digital indicators can be zeroed by command

▪ Pin definition of RS232 plug:

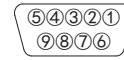

Pin No.	Symbol	Description
2	TXD	Data OUT
3	RXD	Data IN
4	VDD	+5V Power
5	GND	Ground

2) Data output cables without transmit box



7305-G3350

application



Single transmit

Code	Description	Plug to measuring tool	Plug to computer	Connecting with measuring tool	Transmit data
7305-G60	cable for high precision digital indicators (length 3m)				<ul style="list-style-type: none"> ▪ Press the "DATA" button of high precision digital indicator
7305-G3350	cable for digital micrometers (length 3m)				<ul style="list-style-type: none"> ▪ Press the "DATA" button of digital micrometer

communication protocol

- Baud: 9600bps
Data bit: 8
Stop bit 1
Check bit: None
No flow control

▪ Data output format

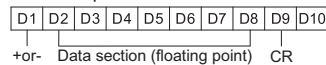

Data format example

Display	Output
1.234	➔ +0001.234 ✓
-1.234	➔ -0001.234 ✓

- Data can be transmitted by command
The digital indicators or micrometers can be zeroed by command

DATA OUTPUT CABLES (KEYBOARD FORMAT)

application

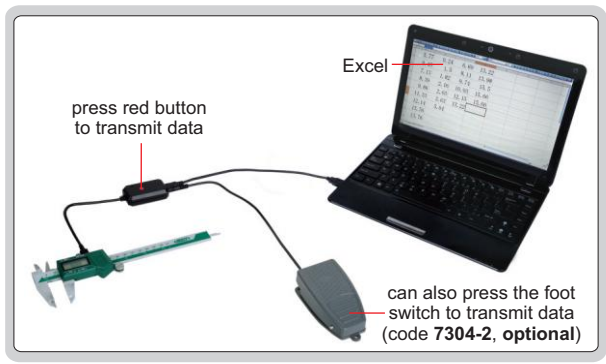

7302-21













- Recognized as HID keyboard device by computer, no need to install drivers and softwares
- Data can be transmitted to Excel, Word, txt and other files (press transmit button, which is recognized by the computer as keyboard input data and press enter key, such as 12.34)
- For any softwares which can receive keyboard signal
- Optional accessory: foot switch (code: **7304-2**), hub (code: **7324-HUB4**, **7324-HUB7**), extension cables (code: **7325-ADD5**, **7325-ADD10**)

Code	Description	Plug	Connecting with measuring tool	Transmit data
7302-21	cable for digital calipers (length 3m)			<ul style="list-style-type: none"> ▪ Press the button on the plug of cable, can also press the button of the transmit box, or press the foot switch ▪ Data is transmitted once, the signal light of the transmit box flashes once
7302-22	cable for large digital calipers (length 2.5m)			<ul style="list-style-type: none"> ▪ Press the button of the transmit box, or press the foot switch ▪ Data is transmitted once, the signal light of the transmit box flashes once
7302-30	cable for digital micrometers (length 2.5m)		 for 3102, 3128, 3565 series digital micrometers	<ul style="list-style-type: none"> ▪ Press the "data" button of digital micrometer, can also press the button of the box, or press the foot switch ▪ Data is transmitted once, the signal light of the transmit box flashes once, at the same time, the signal light on the digital micrometer flashes once
7302-31	cable for digital micrometers (length 2.5m)		 IP65	<ul style="list-style-type: none"> ▪ Press the "data" button of digital micrometer, can also press the button of the transmit box, or press the foot switch ▪ Data is transmitted once, the signal light of the transmit box flashes once, at the same time, the signal light on the digital micrometer flashes once

















To be continued

Continued from previous page

Code	Description	Plug	Connecting with measuring tool	Transmit data
7302-50M	cable for digital gauges (length 2.5m)			<ul style="list-style-type: none"> Press the button of the transmit box, or press the foot switch Data is transmitted once, the signal light of the transmit box flashes once
7302-40M	cable for digital indicators (length 2.5m)		 <p>“DATA” button signal light</p> <p>for 2108, 2138, 2139 series digital indicators</p>	<ul style="list-style-type: none"> Press the “DATA” button of digital indicator, can also press the button of the transmit box, or press the foot switch Data is transmitted once, the signal light of the transmit box flashes once, at the same time, the signal light on digital indicator flashes once <p>Note: long press button to zero the digital indicators</p>
			 <p>for other digital indicators</p>	<ul style="list-style-type: none"> Press the button of the transmit box, or press the foot switch Data is transmitted once, the signal light of the transmit box flashes once <p>Note: long press button to zero the digital indicators</p>
7302-60	cable for high precision digital indicators (length 2.5m)		 <p>“DATA” button</p>	<ul style="list-style-type: none"> Press the “DATA” button of high precision digital indicator, can also press the button of the transmit box, or press the foot switch Data is transmitted once, the signal light of the transmit box flashes once
7302-3350	cable for digital micrometers (length 2.5m)		 <p>“DATA” button</p>	<ul style="list-style-type: none"> Press the “DATA” button of digital micrometer, can also press the button of the transmit box, or press the foot switch Data is transmitted once, the signal light of the transmit box flashes once
7302-1151	cable for digital height gauges (length 2.5m)			<ul style="list-style-type: none"> Press the button of the transmit box, or press the foot switch Data is transmitted once, the signal light of the transmit box flashes once

To be continued

Continued from previous page





Code	Description	Plug	Connecting with measuring tool	Transmit data
7302-SPC7	cable for digital height gauges (length 2.5m)			<ul style="list-style-type: none"> Press the button of the transmit box, or press the foot switch Data is transmitted once, the signal light of the transmit box flashes once
7302-8001	cable for weighing scales (length 2.5m)		  <p>back</p> <p>“” button</p> <p>for 8301 and 8305 series electronic balances</p>	<ul style="list-style-type: none"> Press the “” button of electronic balance, can also press the button of the transmit box, or press the foot switch Data is transmitted once, the signal light of the transmit box flashes once
			  <p>back</p> <p>for 8001-6D, 8001-15D, 8001-30D series weighing scales and 8501 series platform scales</p>	<ul style="list-style-type: none"> Press the button of the transmit box, or press the foot switch Data is transmitted once, the signal light of the transmit box flashes once
7302-8304	cable for electronic balances (length 3m)		  <p>back</p> <p>“” button</p>	<ul style="list-style-type: none"> Press the “” button of electronic balance, can also press the button of the transmit box, or press the foot switch Data is transmitted once, the signal light of the transmit box flashes once
7302-LDM	cable for laser scan micrometers (length 3m)			<ul style="list-style-type: none"> Press the button of the transmit box, or press the foot switch Data is transmitted once, the signal light of the transmit box flashes once

485 DATA OUTPUT CABLES

- Modbus-RTU protocols
- Can be connected to a PC or PLC
- The baud rate is configurable (9600, 19200, 38400)
- The communication address is configurable



7215-50M

Code	Description	Plug	Connecting with measuring tool	Transmit data
7215-21	cable for digital calipers (length 3m)			<ul style="list-style-type: none"> ▪ Acquiring data through host computers
7215-22	cable for digital calipers (length 2.5m)			<ul style="list-style-type: none"> ▪ Acquiring data through host computers
7215-30	cable for digital micrometers (length 2.5m)		 for 3102, 3128, 3565 series digital micrometers  back	<ul style="list-style-type: none"> ▪ Acquiring data through host computers
7215-31	cable for digital micrometers (length 2.5m)		 IP65  back	<ul style="list-style-type: none"> ▪ Acquiring data through host computers
7215-40M	cable for digital indicators (length 2.5m)			<ul style="list-style-type: none"> ▪ Acquiring data through host computers
7215-50M	cable for digital gauges (length 2.5m)			<ul style="list-style-type: none"> ▪ Acquiring data through host computers

INTERFACE BOX AND DATA OUTPUT CABLES



**8-channel interface box
7210-2**



**data output cable
7305-R40M**

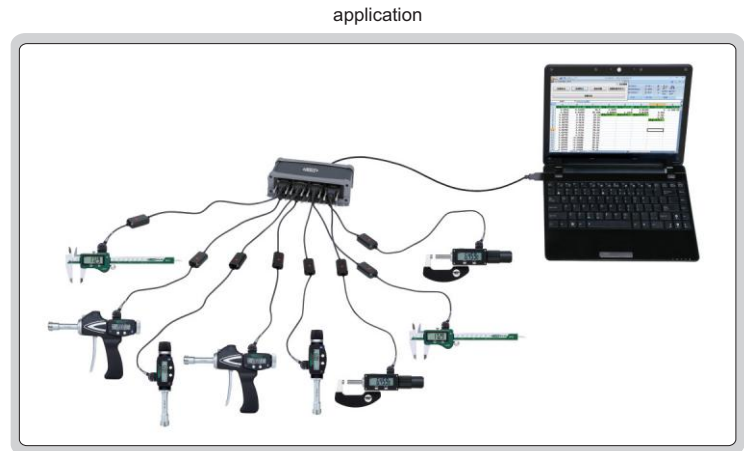

- The interface box can be connected to digital measuring tools, such as calipers, micrometers, indicators (7305-R series data output cables are needed)
- The interface box is supplied with Excel directional input software
- The interface box can be connected with 8 data output cables, each of them has unique identification code

INTERFACE BOX SPECIFICATION

Code	7210-2
Quantity of digital measuring tools to be connected	8 pcs
Output port	USB (virtual serial signal)

Excel directional input software

- Supplied with 7210-2 interface box
- The measurement data of multiple measuring tools can be transmitted to the designated area of Excel, which is convenient for data management and improves efficiency

excel directional input software application example 1

Set the display area of caliper at B4-B9, the readings of caliper are displayed at B4, B5...B9. Set the display area of micrometer at C4-C9, the readings of micrometer are displayed at C4, C5... C9. Set the display area of height gauge at D4-D9, the readings of height gauge are displayed at D4, D5... D9.

	A	B	C	D
1	Project	Length	Width	Height
2	Dimension and Tolerance	50±0.05	24±0.01	10+0.05/-0.06
3	Measuring tool	Caliper	Micrometer	Height gage
4	1	50.02	24.004	9.98
5	2	50.01	24.010	10.01
6	3	49.99	23.990	10.02
7	4	50.00	23.996	9.99
8	5	50.04	24.000	10.01
9	6	Channel 1	Channel 2	Channel 3

serial of workpieces the next data display area is indicated in green

excel directional input software application example 2

Set the display area of micrometer at B4-C9, data input is from the left to the right, the readings of micrometer are displayed at B4, C4, B5, C5... B9, C9. Set the display area of caliper at D4-D9, the readings of caliper are displayed at D4, D5... D9. Set the display area of depth gauge at E4-E9, the readings of depth gauge are displayed at E4, E5... E9.

	A	B	C	D	E
1	Project	External diameter1	External diameter2	Length	Depth
2	Dimension and Tolerance	Φ23+0.01/-0.02	Φ21+0.01/-0.02	50±0.04	28±0.05
3	Measuring tool	Micrometer	Micrometer	Caliper	Depth gage
4	1	23.010	21.008	49.98	28.01
5	2	23.010	21.000	49.98	27.98
6	3	22.999	21.000	50	28
7	4	23.007	20.998	50	28
8	5	23.000	20.985	50.01	28.01
9	6	23.008	Channel 1	Channel 2	Channel 3

serial of workpieces the next data display area is indicated in green

To be continued

Continued from previous page

DATA OUTPUT CABLE SPECIFICATION

Code	Description	Plug to measuring tool	Connecting with measuring tool	Transmit data
7305-R21	cable for digital calipers (length 3m)			<ul style="list-style-type: none"> Press the button on the plug of cable, can also press the button of the transmit box, or press the foot switch Data is transmitted once, the signal light of the transmit box flashes once
7305-R22	cable for large digital calipers (length 2.5m)			<ul style="list-style-type: none"> Press the button of the transmit box, or press the foot switch Data is transmitted once, the signal light of the transmit box flashes once
7305-R30	cable for digital micrometers (length 2.5m)			<ul style="list-style-type: none"> Press the "data" button of digital micrometer, can also press the button of the transmit box, or press the foot switch Data is transmitted once, the signal light of the transmit box flashes once, at the same time, the signal light on the digital micrometer flashes once
7305-R40M	cable for digital indicators (length 2.5m)		<p>suitable for 2108, 2138, 2139 series digital indicators</p>	<ul style="list-style-type: none"> Press the "DATA" button of digital indicator, can also press the button of the transmit box, or press the foot switch Data is transmitted once, the signal light of the transmit box flashes once, at the same time, the signal light on digital indicator flashes once
			<p>suitable for other digital indicators</p>	<ul style="list-style-type: none"> Press the button of the transmit box, or press the foot switch Data is transmitted once, the signal light of the transmit box flashes once
7305-R50M	cable for digital gauges (length 2.5m)			<ul style="list-style-type: none"> Press the button of the transmit box, or press the foot switch Data is transmitted once, the signal light of the transmit box flashes once
7305-R1150	cable for digital height gauges (length 2.5m)			<ul style="list-style-type: none"> Press the button of the transmit box, or press the foot switch Data is transmitted once, the signal light of the transmit box flashes once

connected with digital indicator



DISPLAY UNIT CODE 7106-1A

REFER TO PAGE 563
FOR DETAILS

connected with digital indicators

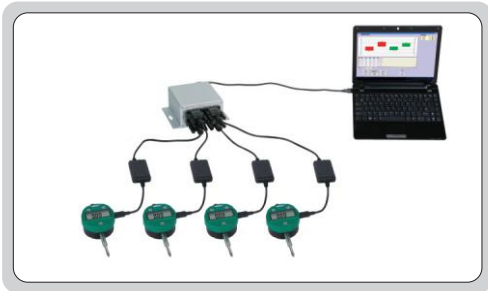

MULTICHANNEL INTERFACE BOXES

REFER TO PAGE 564
FOR DETAILS



7107-1

application

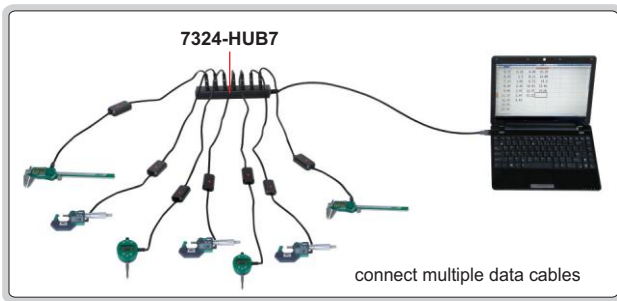

7324-HUB7

connect multiple data cables

HUBS



7324-HUB4



7324-HUB7

adapter (optional)



7324-ADAPTER

- Suitable for USB plug data cable



7324-HUB16

Code	Description	Applicable products	Note
7324-HUB4	4-channel hub (length 0.2m, USB computer plug)	7302 series data cables (USB plug) 7305 series data cables (USB plug)	no adapter required
7324-HUB7	7-channel hub (length 1m, USB computer plug)		optional: adapter (code: 7324-ADAPTER) note: adapter required for connecting high power devices
7324-HUB16	16-channel hub (length 1m, USB computer plug)		adapter is included

EXTENSION CABLES

Code	Description	Applicable products
7325-ADD5	data extension cable (length 5m, USB plug)	7302 series data cables
7325-ADD10	data extension cable (length 10m, USB plug)	7305 series data cables (USB plug)



7325-ADD5

application



FOOT SWITCH



7304-2

- For data transmission

Code	Description	Applicable products
7304-2	data transmission foot switch with cable (length 2m)	7302 series data cables 7305 series data cables

application

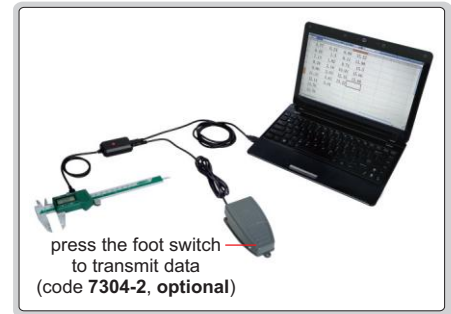

OK/NG INPUT SWITCHES



7327-FS



7327-SW

- Used with 7317 software, output OK or NG
- USB plug, length 1.5m

Code	Description
7327-FS	foot switch for OK/NG input
7327-SW	hand switch for OK/NG input

application



MOBILE WORKBENCH



7901-10A

application

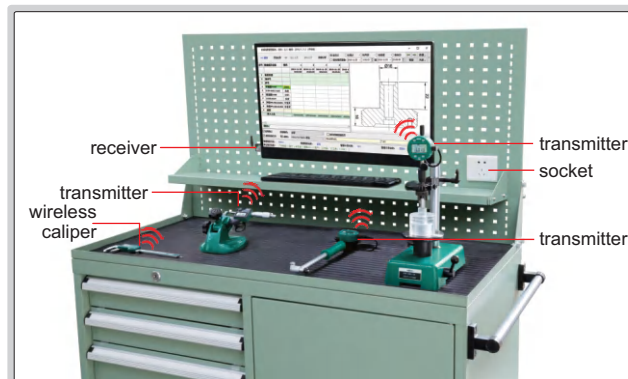

- Tabletop can support 50kg

Code	L×W×H (without caster)
7901-10A	1103×580×1502mm

Unit: mm

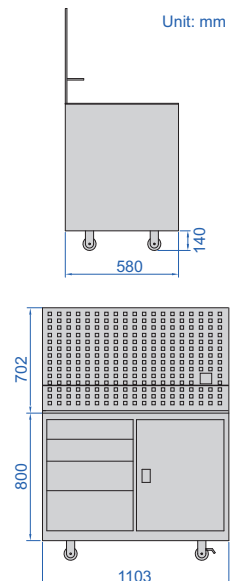



Digital Calipers
Page 29-37



Vernier Calipers
Page 37-40



Dial Calipers
Page 41



Caliper/Height Gauge Checkers
Page 47



Caliper End Grinding Machines
Page 47



Depth Base Attachments
Page 48

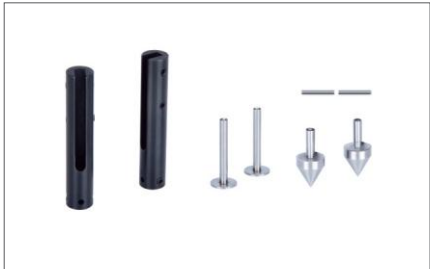

Accessory Sets For Digital Calipers
Page 48-49



Special Purpose Calipers
Page 50-83

IP67 WATERPROOF DIGITAL CALIPERS

INSIZE PLUS
MADE IN EUROPE

INSPECTION
CERTIFICATE

DATA
OUTPUT

IP67
WATERPROOF

2

- IP67 dust/waterproof
- Resolution: 0.01mm/0.0005"
- Button function: zero, mm/inch, preset, data output
- Battery CR2032
- Automatic power off, move the digital unit to turn on power
- Data output
- Meet DIN862
- Made of stainless steel
- Optional accessory:
 - wireless transmitter code **7315-80** (receiver is needed) page 7,
 - data output cable code **7302-80**,
 - accessory set for digital calipers (code **6144**, only for range 0-150mm and 0-200mm),
 - depth base attachment (code **6140**)



1195-150

Code	Range	Accuracy	Thumb roller	L	a	b	c	d	Remark
1195-150*	0-150mm/0-6"	±0.02mm	with	235	21	16.5	16	40	with depth bar
1195-200*	0-200mm/0-8"	±0.03mm	with	290	24.5	20	16	50	with depth bar
1195-300*	0-300mm/0-12"	±0.03mm	with	387	23	18.5	16	64	without depth bar

* Supplied with manufacturer inspection certificate

(mm)

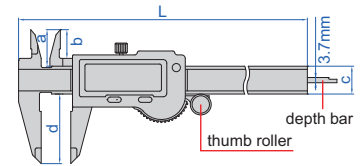

IP67 WATERPROOF DIGITAL CALIPERS

ATTENTION: IT IS NECESSARY TO SET
ZERO AFTER POWER ON EACH TIME

ATTENTION:
NO DATA OUTPUT

IP67
WATERPROOF

INSPECTION
CERTIFICATE



1118-150B

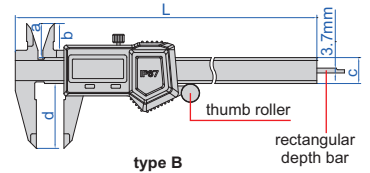

type B

- IP67 dust/waterproof
- Resolution: 0.01mm/0.0005"
- Button function: zero, on/off, mm/inch, ABS/REL, hold
- Battery CR2032
- Meet DIN862
- Made of stainless steel
- Optional accessory:
 - accessory set for digital calipers (code **6144**, only for range 0-150mm and 0-200mm),
 - depth base attachment (code **6140**)



1118-150R

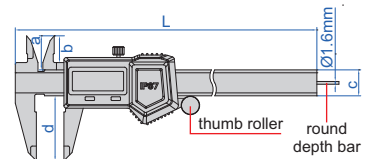

type R

Code	Range	Accuracy	Thumb roller	Type	L	a	b	c	d
1118-150B*	0-150mm/0-6"	±0.03mm	with	B	236mm	21mm	16mm	16mm	40mm
1118-200B*	0-200mm/0-8"	±0.03mm	with	B	286mm	24mm	19mm	16mm	50mm
1118-300B*	0-300mm/0-12"	±0.03mm	with	B	400mm	25mm	20.5mm	16mm	60mm
1118-150BW*	0-150mm/0-6"	±0.03mm	without	B	236mm	21mm	16mm	16mm	40mm
1118-200BW*	0-200mm/0-8"	±0.03mm	without	B	286mm	24mm	19mm	16mm	50mm
1118-300BW*	0-300mm/0-12"	±0.03mm	without	B	400mm	25mm	20.5mm	16mm	60mm
1118-150R*	0-150mm/0-6"	±0.03mm	with	R	236mm	21mm	16mm	16mm	40mm
1118-150RW*	0-150mm/0-6"	±0.03mm	without	R	236mm	21mm	16mm	16mm	40mm

* Supplied with manufacturer inspection certificate

ATTENTION: THE WORKING LIFE OF A BATTERY IS ABOUT 3-5 MONTHS

WIRELESS DIGITAL CALIPERS (ZIGBEE)

INSPECTION CERTIFICATE

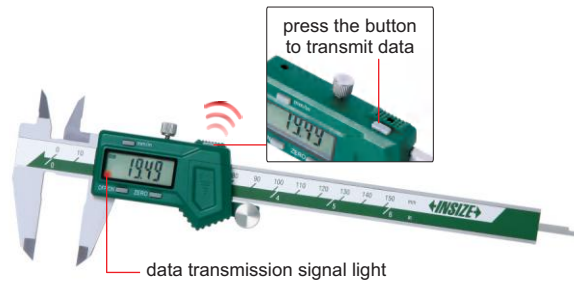

press the button to transmit data

data transmission signal light

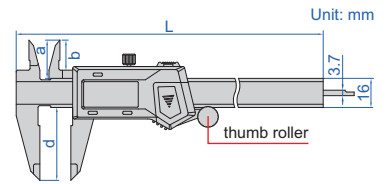

Unit: mm

thumb roller

1113-150

- Non waterproof
- Built-in wireless data transmission module, Zigbee signal
- Transmission distance is 10 meter (under the condition of no obstruction and no electromagnetic interference)
- Resolution: 0.01mm/0.0005"
- Buttons: on/off, zero, mm/inch, data transmission
- Automatic power off, move the digital unit to turn on power
- Battery CR2032
- Made of stainless steel
- Optional accessory: receiver (code 7315-2/3/6/7/8/9), accessory set for digital calipers (code 6144, only for range 0-150mm and 0-200mm), depth base attachment (code 6140)

application

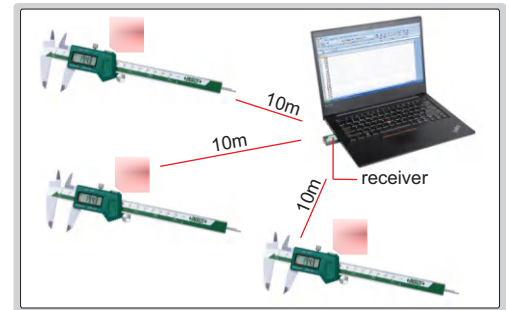

Code	Range	Accuracy	Thumb roller	L	a	b	d
1113-150 *	0-150mm/0-6"	±0.03mm	with	236	21	16	40
1113-200 *	0-200mm/0-8"	±0.03mm	with	286	24	19	50
1113-300 *	0-300mm/0-12"	±0.03mm	with	400	25	20.5	60
1113-150W *	0-150mm/0-6"	±0.03mm	without	236	21	16	40
1113-200W *	0-200mm/0-8"	±0.03mm	without	286	24	19	50
1113-300W *	0-300mm/0-12"	±0.03mm	without	400	25	20.5	60

(mm)

receiver (optional)

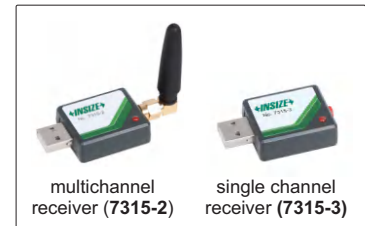

multichannel receiver (7315-2)

single channel receiver (7315-3)

* Supplied with manufacturer inspection certificate

POPULAR MODEL

DIGITAL CALIPERS (STANDARD TYPE)

- Non waterproof
- Resolution: 0.01mm/0.0005"
- Buttons: on/off, zero, mm/inch
- Automatic power off, move the digital unit to turn on power
- Battery CR2032
- Data output
- Meet DIN862
- Made of stainless steel
- Optional accessory: wireless transmitter code 7315-25 (receiver is needed) page 5, bluetooth transmitter code 7214-25 page 11, data output cable code 7302-21 page 20, accessory set for digital calipers (code 6144, only for range 0-150mm and 0-200mm), depth base attachment (code 6140)

INSPECTION CERTIFICATE

DATA OUTPUT



1108-150

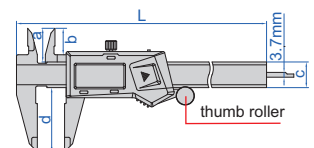

Unit: mm

thumb roller

Code	Range	Accuracy	Thumb roller	L	a	b	c	d
1108-150 *	0-150mm/0-6"	±0.02mm	with	236mm	21mm	16mm	16mm	40mm
1108-200 *	0-200mm/0-8"	±0.03mm	with	286mm	24mm	19mm	16mm	50mm
1108-250 *	0-250mm/0-10"	±0.03mm	with	350mm	25mm	20.5mm	16mm	60mm
1108-300 *	0-300mm/0-12"	±0.03mm	with	400mm	25mm	20.5mm	16mm	60mm
1108-150W *	0-150mm/0-6"	±0.02mm	without	236mm	21mm	16mm	16mm	40mm
1108-200W *	0-200mm/0-8"	±0.03mm	without	286mm	24mm	19mm	16mm	50mm
1108-300W *	0-300mm/0-12"	±0.03mm	without	400mm	25mm	20.5mm	16mm	60mm

* Supplied with manufacturer inspection certificate

DIGITAL CALIPERS (ABSOLUTE SYSTEM)



DATA OUTPUT

2

- Non waterproof
- Absolute system, low power consumption, long battery life
- Resolution: 0.01mm/0.0005"
- Buttons: on/off, mm/inch, ORIGIN, ZERO/ABS
- Automatic power off, move the digital unit to turn on power
- Battery CR2032
- Data output
- Meet DIN862
- Made of stainless steel
- Optional accessory:
 - wireless transmitter code **7315-22** (receiver is needed) page 5,
 - bluetooth transmitter code **7214-22** page 11,
 - data output cable code **7302-22** page 20,
 - accessory set for digital calipers (code **6144**, only for range 0-150mm and 0-200mm),
 - depth base attachment (code **6140**)



1103-150

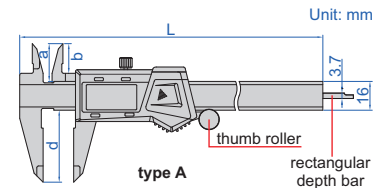

Code	Range	Accuracy	Thumb roller	Type	L	a	b	d
1103-150*	0-150mm/0-6"	±0.03mm	with	A	236mm	21mm	16.5mm	40mm
1103-200*	0-200mm/0-8"	±0.03mm	with	A	286mm	24mm	19.5mm	50mm
1103-300*	0-300mm/0-12"	±0.03mm	with	A	400mm	26mm	21.5mm	60mm
1103-150W*	0-150mm/0-6"	±0.03mm	without	A	236mm	21mm	16.5mm	40mm
1103-200W*	0-200mm/0-8"	±0.03mm	without	A	286mm	24mm	19.5mm	50mm
1103-300W*	0-300mm/0-12"	±0.03mm	without	A	400mm	26mm	21.5mm	60mm
1103-150R*	0-150mm/0-6"	±0.03mm	with	R	236mm	21mm	16.5mm	40mm
1103-150RW*	0-150mm/0-6"	±0.03mm	without	R	236mm	21mm	16.5mm	40mm

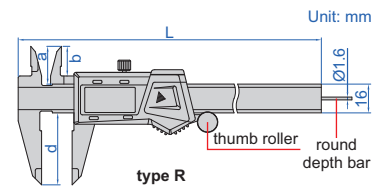

*Supplied with manufacturer inspection certificate

DIGITAL CALIPERS



ATTENTION: NO DATA OUTPUT

- Non waterproof
- Zinc alloy housing for digital unit
- Resolution: 0.01mm/0.0005"
- Buttons: zero, on/off, mm/inch
- Automatic power off, move the digital unit to turn on power
- Battery CR2032
- Meet DIN862
- Made of stainless steel
- Optional accessory:
 - accessory set for digital calipers (code **6144**, only for range 0-150mm and 0-200mm),
 - depth base attachment (code **6140**)



1114-150A

Code	Range	Accuracy	Thumb roller	L	a	b	c	d
1114-150A*	0-150mm/0-6"	±0.03mm	with	236mm	21mm	16mm	16mm	40mm
1114-200A*	0-200mm/0-8"	±0.03mm	with	286mm	24mm	19mm	16mm	50mm
1114-300A*	0-300mm/0-12"	±0.03mm	with	400mm	25mm	20.5mm	17mm	60mm
1114-150AW*	0-150mm/0-6"	±0.03mm	without	236mm	21mm	16mm	16mm	40mm
1114-200AW*	0-200mm/0-8"	±0.03mm	without	286mm	24mm	19mm	16mm	50mm
1114-300AW*	0-300mm/0-12"	±0.03mm	without	400mm	25mm	20.5mm	17mm	60mm

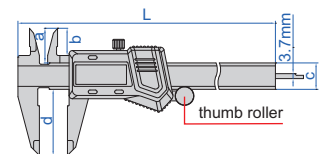

*Supplied with manufacturer inspection certificate

DIGITAL CALIPERS (FRACTION READING)



1102-150

- Non waterproof
- Resolution: 1/128", 0.01mm, 0.0005"
- Buttons: unit (inch fraction/mm/inch), on/off, zero
- Automatic power off, move the digital unit to turn on power
- Battery CR2032
- Data output (for mm and inch)
- Meet DIN862
- Made of stainless steel
- Optional accessory: wireless transmitter code **7315-25** (receiver is needed) page 5, bluetooth transmitter code **7214-25** page 11, data output cable code **7302-21** page 20, accessory set for digital calipers (code **6144**, only for range 0-150mm and 0-200mm), depth base attachment (code **6140**)



inch fraction reading



mm reading



inch reading

Code	Range	Accuracy	Thumb roller	L	a	b	d
1102-150 *	0-150mm/0-6"	±0.02mm	with	236mm	21mm	16mm	40mm
1102-200 *	0-200mm/0-8"	±0.03mm	with	286mm	24mm	19mm	50mm
1102-300 *	0-300mm/0-12"	±0.03mm	with	400mm	25mm	20.5mm	60mm
1102-150W *	0-150mm/0-6"	±0.02mm	without	236mm	21mm	16mm	40mm
1102-200W *	0-200mm/0-8"	±0.03mm	without	286mm	24mm	19mm	50mm
1102-300W *	0-300mm/0-12"	±0.03mm	without	400mm	25mm	20.5mm	60mm

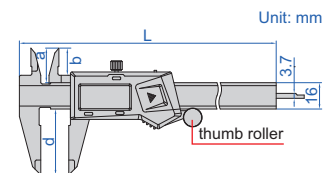

*Supplied with manufacturer inspection certificate

HEAVY DUTY 300mm DIGITAL CALIPER

- Non waterproof
- Resolution: 0.01mm/0.0005"
- Buttons: on/off, zero, mm/inch
- Automatic power off, move the digital unit to turn on power
- Battery CR2032
- Data output
- Meet DIN862
- Made of stainless steel
- Optional accessory: wireless transmitter code **7315-22** (receiver is needed) page 5, bluetooth transmitter code **7214-22** page 11, data output cable code **7302-22** page 20



1196-300

Code	Range	Thumb roller	Accuracy
1196-300 *	0-300mm/0-12"	with	±0.03mm
1196-300W *	0-300mm/0-12"	without	±0.03mm

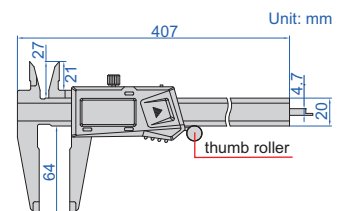

*Supplied with manufacturer inspection certificate

METRIC DIGITAL CALIPERS



LOCK READING WITH
"HOLD" BUTTON

DATA
OUTPUT

2

- Non waterproof
- Resolution: 0.01mm
- Buttons: on/off, zero, hold
- Automatic power off, move the digital unit to turn on power
- Battery CR2032
- Data output
- Meet DIN862
- Made of stainless steel
- Optional accessory:
 - wireless transmitter code **7315-25** (receiver is needed) page 5,
 - bluetooth transmitter code **7214-25** page 11,
 - data output cable code **7302-21** page 20,
 - accessory set for digital calipers (code **6144**, only for range 0-150mm and 0-200mm),
 - depth base attachment (code **6140**)



1109-150

Code	Range	Accuracy	Thumb roller	L	a	b	c	d
1109-150*	0-150mm	±0.03mm	with	236mm	21mm	16mm	16mm	40mm
1109-200*	0-200mm	±0.03mm	with	286mm	24mm	19mm	16mm	50mm
1109-300*	0-300mm	±0.03mm	with	400mm	25mm	20.5mm	16mm	60mm
1109-150W*	0-150mm	±0.03mm	without	236mm	21mm	16mm	16mm	40mm
1109-200W*	0-200mm	±0.03mm	without	286mm	24mm	19mm	16mm	50mm
1109-300W*	0-300mm	±0.03mm	without	400mm	25mm	20.5mm	16mm	60mm

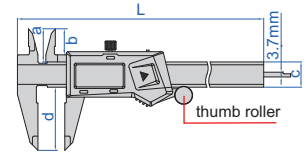

*Supplied with manufacturer inspection certificate

DIGITAL CALIPERS WITH ROUND DEPTH BAR



DATA
OUTPUT

- Non waterproof
- Resolution: 0.01mm/0.0005"
- Buttons: on/off, zero, mm/inch
- Automatic power off, move the digital unit to turn on power
- Battery CR2032
- Meet DIN862
- Made of stainless steel
- Optional accessory:
 - accessory set for digital calipers (code **6144**),
 - depth base attachment (code **6140**)



1119-150

With data interface
(optional data output cable: code **7315-25** receiver is needed page 5, **7214-25** page 11, **7302-21** page 20)

Code	Range	Accuracy	Thumb roller	L	a	b	c	d
1119-150*	0-150mm/0-6"	±0.03mm	with	236mm	21mm	16mm	16mm	40mm
1119-150W*	0-150mm/0-6"	±0.03mm	without	236mm	21mm	16mm	16mm	40mm

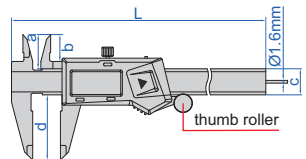

Built-in wireless (receiver code 7315-2/3/6/7/8/9 is needed)

Code	Range	Accuracy	Thumb roller	L	a	b	c	d
1119-150WL*	0-150mm/0-6"	±0.03mm	with	236mm	21mm	16mm	16mm	40mm
1119-150WWL*	0-150mm/0-6"	±0.03mm	without	236mm	21mm	16mm	16mm	40mm



round depth
bar Ø1.6mm

*Supplied with manufacturer inspection certificate

DATA
OUTPUT

INSPECTION
CERTIFICATE

LEFT HAND DIGITAL CALIPERS

2

- Non waterproof
- Designed for left handed users
- Resolution: 0.01mm/0.0005"
- Buttons: on/off, zero, mm/inch
- Automatic power off, move the digital unit to turn on power
- Battery CR2032
- Data output
- Meet DIN862
- Made of stainless steel
- Optional accessory:
wireless transmitter code **7315-22** (receiver is needed) page 5,
bluetooth transmitter code **7214-22** page 11,
data output cable code **7302-22** page 20,
accessory set for digital calipers (code **6144**, only for range 0-150mm and 0-200mm),
depth base attachment (code **6140**)



1130-150

Code	Range	Accuracy	Thumb roller	L	a	b	d
1130-150*	0-150mm/0-6"	±0.03mm	with	236mm	21mm	16mm	40mm
1130-200*	0-200mm/0-8"	±0.03mm	with	286mm	24mm	19mm	50mm
1130-300*	0-300mm/0-12"	±0.03mm	with	400mm	25mm	20.5mm	60mm
1130-150W*	0-150mm/0-6"	±0.03mm	without	236mm	21mm	16mm	40mm
1130-200W*	0-200mm/0-8"	±0.03mm	without	286mm	24mm	19mm	50mm
1130-300W*	0-300mm/0-12"	±0.03mm	without	400mm	25mm	20.5mm	60mm

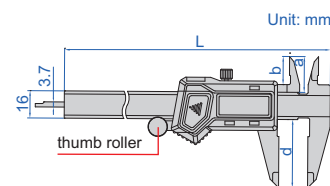

*Supplied with manufacturer inspection certificate

DATA
OUTPUT

INSPECTION
CERTIFICATE

DIGITAL CALIPERS WITH CERAMIC TIPPED JAWS

- Non waterproof
- Ceramic tipped jaws for outside measurement, extremely wear-resistant, non-magnetic and non electric conductive
- Resolution: 0.01mm/0.0005"
- Buttons: on/off, zero, mm/inch
- Automatic power off, move the digital unit to turn on power
- Battery CR2032, made of stainless steel
- Meet DIN862
- Optional accessory:
depth base attachment (code **6140**)



1193-150

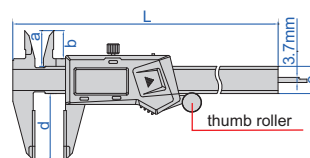

ceramic
tipped jaws



With data interface

(optional data output cable: code **7315-25** receiver is needed page 5, **7214-25** page 11, **7302-21** page 20)

Code	Range	Accuracy	Thumb roller	L	a	b	c	d
1193-150*	0-150mm/0-6"	±0.03mm	with	235mm	21mm	16.5mm	16mm	40mm
1193-200*	0-200mm/0-8"	±0.03mm	with	287mm	24mm	20mm	16mm	50mm
1193-300*	0-300mm/0-12"	±0.03mm	with	390mm	26mm	21.5mm	16mm	60mm
1193-150W*	0-150mm/0-6"	±0.03mm	without	235mm	21mm	16.5mm	16mm	40mm
1193-200W*	0-200mm/0-8"	±0.03mm	without	297mm	24mm	20mm	16mm	50mm
1193-300W*	0-300mm/0-12"	±0.03mm	without	390mm	26mm	21.5mm	16mm	60mm

Built-in wireless (receiver code **7315-2/3/6/7/8/9** is needed)

Code	Range	Accuracy	Thumb roller	L	a	b	c	d
1193-150WL*	0-150mm/0-6"	±0.03mm	with	235mm	21mm	16.5mm	16mm	40mm
1193-200WL*	0-200mm/0-8"	±0.03mm	with	287mm	24mm	20mm	16mm	50mm
1193-300WL*	0-300mm/0-12"	±0.03mm	with	390mm	26mm	21.5mm	16mm	60mm
1193-150WWL*	0-150mm/0-6"	±0.03mm	without	235mm	21mm	16.5mm	16mm	40mm
1193-200WWL*	0-200mm/0-8"	±0.03mm	without	297mm	24mm	20mm	16mm	50mm
1193-300WWL*	0-300mm/0-12"	±0.03mm	without	390mm	26mm	21.5mm	16mm	60mm

*Supplied with manufacturer inspection certificate

DIGITAL CALIPERS WITH CARBIDE TIPPED JAWS

2

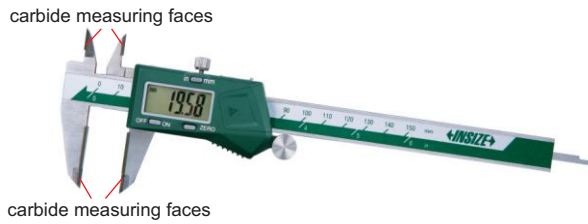

1110-150A

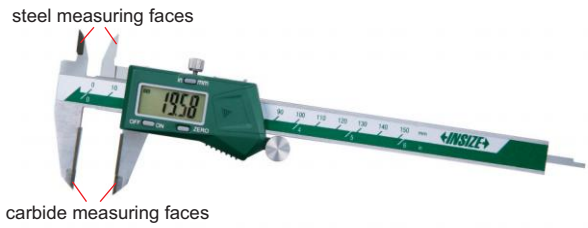

1110-150B

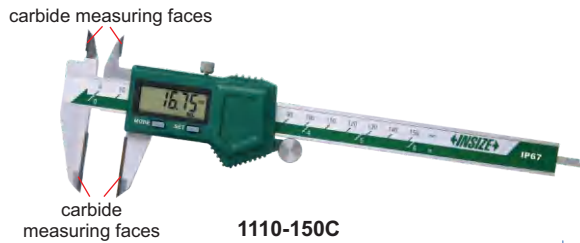

1110-150C

- Resolution: 0.01mm/0.0005"
- Buttons: on/off, zero, mm/inch
- Automatic power off, move the digital unit to turn on power
- Battery CR2032
- Meet DIN862
- Made of stainless steel
- Optional accessory: depth base attachment (code 6140)

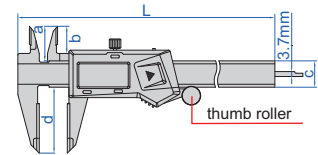

Non waterproof, with data interface

(optional data output cable: code 7315-25 receiver is needed page 5, 7214-25 page 11, 7302-21 page 20)

Code	Range	Accuracy	Thumb roller	L	a	b	c	d	Remark
1110-150A *	0-150mm/0-6"	±0.03mm	with	236mm	21mm	16mm	16mm	40mm	carbide tipped upper and lower jaws
1110-200A *	0-200mm/0-8"	±0.03mm	with	286mm	24mm	19mm	16mm	50mm	carbide tipped upper and lower jaws
1110-300A *	0-300mm/0-12"	±0.03mm	with	400mm	25mm	20.5mm	16mm	60mm	carbide tipped upper and lower jaws
1110-150AW *	0-150mm/0-6"	±0.03mm	without	236mm	21mm	16mm	16mm	40mm	carbide tipped upper and lower jaws
1110-200AW *	0-200mm/0-8"	±0.03mm	without	286mm	24mm	19mm	16mm	50mm	carbide tipped upper and lower jaws
1110-300AW *	0-300mm/0-12"	±0.03mm	without	400mm	25mm	20.5mm	16mm	60mm	carbide tipped upper and lower jaws
1110-150B *	0-150mm/0-6"	±0.03mm	with	236mm	21mm	16mm	16mm	40mm	carbide tipped lower jaws
1110-200B *	0-200mm/0-8"	±0.03mm	with	286mm	24mm	19mm	16mm	50mm	carbide tipped lower jaws
1110-300B *	0-300mm/0-12"	±0.03mm	with	400mm	25mm	20.5mm	16mm	60mm	carbide tipped lower jaws
1110-150BW *	0-150mm/0-6"	±0.03mm	without	236mm	21mm	16mm	16mm	40mm	carbide tipped lower jaws
1110-200BW *	0-200mm/0-8"	±0.03mm	without	286mm	24mm	19mm	16mm	50mm	carbide tipped lower jaws
1110-300BW *	0-300mm/0-12"	±0.03mm	without	400mm	25mm	20.5mm	16mm	60mm	carbide tipped lower jaws

Non waterproof, built-in wireless (receiver code 7315-2/3/6/7/8/9 is needed)

Code	Range	Accuracy	Thumb roller	L	a	b	c	d	Remark
1110-150AWL *	0-150mm/0-6"	±0.03mm	with	236mm	21mm	16mm	16mm	40mm	carbide tipped upper and lower jaws
1110-200AWL *	0-200mm/0-8"	±0.03mm	with	286mm	24mm	19mm	16mm	50mm	carbide tipped upper and lower jaws
1110-300AWL *	0-300mm/0-12"	±0.03mm	with	400mm	25mm	20.5mm	16mm	60mm	carbide tipped upper and lower jaws
1110-150AWWL *	0-150mm/0-6"	±0.03mm	without	236mm	21mm	16mm	16mm	40mm	carbide tipped upper and lower jaws
1110-200AWWL *	0-200mm/0-8"	±0.03mm	without	286mm	24mm	19mm	16mm	50mm	carbide tipped upper and lower jaws
1110-300AWWL *	0-300mm/0-12"	±0.03mm	without	400mm	25mm	20.5mm	16mm	60mm	carbide tipped upper and lower jaws
1110-150BWL *	0-150mm/0-6"	±0.03mm	with	236mm	21mm	16mm	16mm	40mm	carbide tipped lower jaws
1110-200BWL *	0-200mm/0-8"	±0.03mm	with	286mm	24mm	19mm	16mm	50mm	carbide tipped lower jaws
1110-300BWL *	0-300mm/0-12"	±0.03mm	with	400mm	25mm	20.5mm	16mm	60mm	carbide tipped lower jaws
1110-150BWWL *	0-150mm/0-6"	±0.03mm	without	236mm	21mm	16mm	16mm	40mm	carbide tipped lower jaws
1110-200BWWL *	0-200mm/0-8"	±0.03mm	without	286mm	24mm	19mm	16mm	50mm	carbide tipped lower jaws
1110-300BWWL *	0-300mm/0-12"	±0.03mm	without	400mm	25mm	20.5mm	16mm	60mm	carbide tipped lower jaws

IP67 dust/waterproof, without data interface

Code	Range	Accuracy	Thumb roller	L	a	b	c	d	Remark
1110-150C *	0-150mm/0-6"	±0.03mm	with	236mm	21mm	16mm	16mm	40mm	carbide tipped upper and lower jaws
1110-150D *	0-150mm/0-6"	±0.03mm	with	236mm	21mm	16mm	16mm	40mm	carbide tipped lower jaws
1110-150CW *	0-150mm/0-6"	±0.03mm	without	236mm	21mm	16mm	16mm	40mm	carbide tipped upper and lower jaws
1110-150DW *	0-150mm/0-6"	±0.03mm	without	236mm	21mm	16mm	16mm	40mm	carbide tipped lower jaws

* Supplied with manufacturer inspection certificate

DATA OUTPUT

DIGITAL CALIPERS

- Non waterproof
- Resolution: 0.01mm/0.0005"
- Buttons: on/off, zero, mm/inch
- Automatic power off, move the digital unit to turn on power
- Battery CR2032
- Made of stainless steel



1170-300

With data interface (optional data output cable: code 7315-25 receiver is needed page 5, 7214-25 page 11, 7302-21 page 20)

Code	Range	Accuracy	a	c	d	e	L
1170-200	0-200mm/0-8"	±0.03mm	12mm	17mm	60mm	10mm	314mm
1170-306	0-300mm/0-12"	±0.04mm	12mm	17mm	60mm	10mm	420mm
1170-300	0-300mm/0-12"	±0.06mm	12mm	17mm	90mm	10mm	420mm

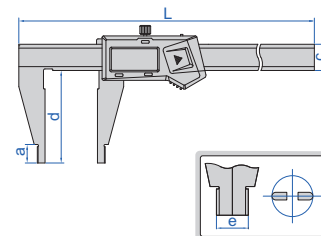

Built-in wireless (receiver code 7315-2/3/6/7/8/9 is needed)

Code	Range	Accuracy	a	c	d	e	L
1170-200WL	0-200mm/0-8"	±0.03mm	12mm	17mm	60mm	10mm	314mm
1170-306WL	0-300mm/0-12"	±0.04mm	12mm	17mm	60mm	10mm	420mm
1170-300WL	0-300mm/0-12"	±0.06mm	12mm	17mm	90mm	10mm	420mm

DATA OUTPUT

DIGITAL CALIPERS

- Non waterproof
- Resolution: 0.01mm/0.0005"
- Buttons: on/off, zero, mm/inch
- Automatic power off, move the digital unit to turn on power
- Battery CR2032
- Made of stainless steel



1171-300

With data interface (optional data output cable: code 7315-25 receiver is needed page 5, 7214-25 page 11, 7302-21 page 20)

Code	Range	Accuracy	a	b	c	d	e	L
1171-200	0-200mm/0-8"	±0.03mm	12mm	38mm	17mm	60mm	10mm	320mm
1171-250	0-250mm/0-10"	±0.03mm	12mm	38mm	17mm	60mm	10mm	365mm
1171-306	0-300mm/0-12"	±0.04mm	12mm	38mm	17mm	60mm	10mm	420mm
1171-300	0-300mm/0-12"	±0.06mm	12mm	38mm	17mm	90mm	10mm	420mm

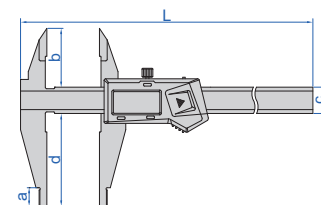

Built-in wireless (receiver code 7315-2/3/6/7/8/9 is needed)

Code	Range	Accuracy	a	b	c	d	e	L
1171-200WL	0-200mm/0-8"	±0.03mm	12mm	38mm	17mm	60mm	10mm	320mm
1171-250WL	0-250mm/0-10"	±0.03mm	12mm	38mm	17mm	60mm	10mm	365mm
1171-306WL	0-300mm/0-12"	±0.04mm	12mm	38mm	17mm	60mm	10mm	420mm
1171-300WL	0-300mm/0-12"	±0.06mm	12mm	38mm	17mm	90mm	10mm	420mm

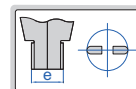

MINI DIGITAL CALIPERS

ATTENTION:
NO DATA OUTPUT

2

- Non waterproof
- Resolution: 0.01mm/0.0005"
- Buttons: zero, mm/inch, on/off
- Automatic power off, move the digital unit to turn on power
- Battery LR44
- Meet DIN862
- Made of stainless steel



1111-100A

Code	Range	Accuracy	L
1111-75A	0-75mm/0-3"	±0.02mm	144mm
1111-100A	0-100mm/0-4"	±0.02mm	170mm

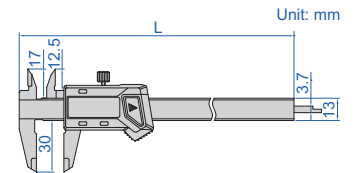

PLASTIC DIGITAL CALIPER

ATTENTION:
NO DATA OUTPUT

- Non waterproof
- Made of hard plastic, non-magnetic and non electric conductive
- Prevent workpieces from scratching by calipers
- Resolution: 0.01mm/0.0005"
- Buttons: on/off, zero, mm/inch
- Battery CR2032, automatic power off



1139-150

Code	Range	Accuracy
1139-150	0-150mm/0-6"	±0.1mm

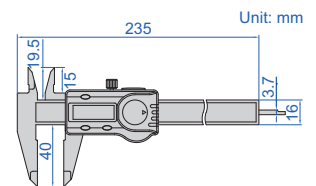

MINI VERNIER CALIPERS

- Meet DIN862
- Made of stainless steel
- Satin chrome plated reading surface

Code	Range	Graduation	Accuracy
1204-70	0-70mm	0.05mm	±0.05mm

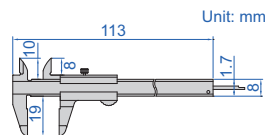

1204-70

Code	Range	Graduation	Accuracy
1203-1003	0-100mm	0.05mm	±0.05mm

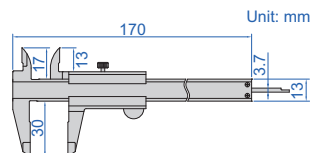

1203-1003

Code	Range	Graduation	Accuracy
1201-1003	0-100mm	0.05mm	±0.05mm

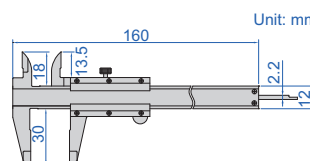

1201-1003

POPULAR MODEL

VERNIER CALIPERS

2



1205-150S

Graduation 0.05mm/1/128" (mm)

Code	Range	Accuracy	L	a	b	c	d
1205-150S	0-150mm/0-6"	±0.05mm	235	20.5	15.5	16	40
1205-200S	0-200mm/0-8"	±0.05mm	290	23.5	19	17	50
1205-250S	0-250mm/0-10"	±0.05mm	364	27.5	22	20	64
1205-300S	0-300mm/0-12"	±0.05mm	414	27.5	22	20	64

Graduation 0.05mm (mm)

Code	Range	Accuracy	L	a	b	c	d
1205-1503S	0-150mm	±0.05mm	235	20.5	15.5	16	40
1205-2003S	0-200mm	±0.05mm	290	23.5	19	17	50
1205-2503S	0-250mm	±0.05mm	350	26	21.5	16	60
1205-3003S	0-300mm	±0.05mm	414	27.5	22	20	64

Graduation 0.02mm/0.001" (mm)

Code	Range	Accuracy	L	a	b	c	d
1205-1502S	0-150mm/0-6"	±0.03mm	235	20.5	15.5	16	40
1205-2002S	0-200mm/0-8"	±0.03mm	290	23.5	19	17	50
1205-2502S	0-250mm/0-10"	±0.03mm	364	27.5	22	20	64
1205-3002S	0-300mm/0-12"	±0.03mm	414	27.5	22	20	64

Graduation 0.02mm (mm)

Code	Range	Accuracy	L	a	b	c	d
1205-1501S	0-150mm	±0.03mm	235	20.5	15.5	16	40
1205-2001S	0-200mm	±0.03mm	290	23.5	19	17	50
1205-2501S	0-250mm	±0.03mm	350	26	21.5	16	60
1205-3001S	0-300mm	±0.03mm	414	27.5	22	20	64

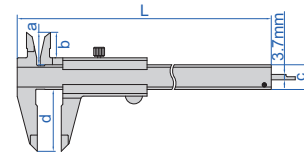

- Meet DIN862
- Made of stainless steel
- Satin chrome plated reading surface

VERNIER CALIPER WITH ROUND DEPTH BAR



1202-150

- Graduation 0.05mm/1/128"
- Round depth bar
- Meet DIN862
- Made of stainless steel
- Satin chrome plated reading surface

Code	Range	Accuracy
1202-150	0-150mm/0-6"	±0.05mm

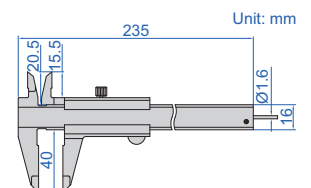

VERNIER CALIPERS WITH FINE ADJUSTMENT

- Graduation 0.02mm/0.001"
- With fine adjustment
- Meet DIN862
- Made of stainless steel
- Satin chrome plated reading surface

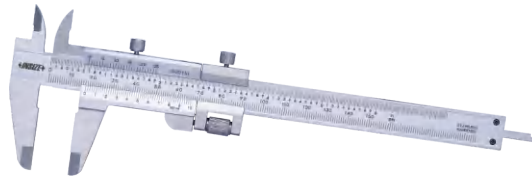

1233-130

Code	Range	Accuracy	L	a	b	c	d	(mm)
1233-130	0-130mm/0-5"	±0.03mm	230	20.5	16.5	16	40	
1233-180	0-180mm/0-7"	±0.03mm	295	23.5	19	16	50	
1233-280	0-280mm/0-11"	±0.03mm	410	26	20	20	60	

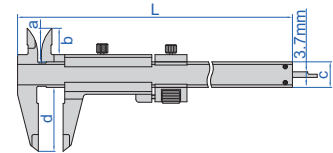

VERNIER CALIPERS WITH THUMB CLAMP

- Meet DIN862
- With thumb clamp
- Made of stainless steel
- Satin chrome plated reading surface

Graduation 0.05mm/1/128" (mm)

Code	Range	Accuracy	L	a	b	c	d	(mm)
1223-150	0-150mm/0-6"	±0.05mm	230	20.5	16.5	16	40	
1223-200	0-200mm/0-8"	±0.05mm	295	23.5	19	16	50	



1223-150

Graduation 0.02mm/0.001" (mm)

Code	Range	Accuracy	L	a	b	c	d	(mm)
1223-1502	0-150mm/0-6"	±0.03mm	230	20.5	16.5	16	40	
1223-2002	0-200mm/0-8"	±0.03mm	295	23.5	19	16	50	

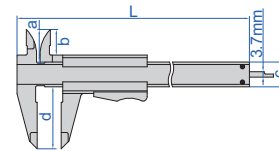

VERNIER CALIPERS WITH CARBIDE TIPPED JAWS

- Carbide tipped jaws for inside and outside measurements
- Meet DIN862
- Made of stainless steel
- Satin chrome plated reading surface

Graduation 0.05mm/1/128" (mm)

Code	Range	Accuracy	L	a	b	c	d	(mm)
1238-150	0-150mm/0-6"	±0.05mm	230	21	16.5	16	40	
1238-200	0-200mm/0-8"	±0.05mm	295	24	19	16	50	
1238-300	0-300mm/0-12"	±0.05mm	410	25	20	16	60	

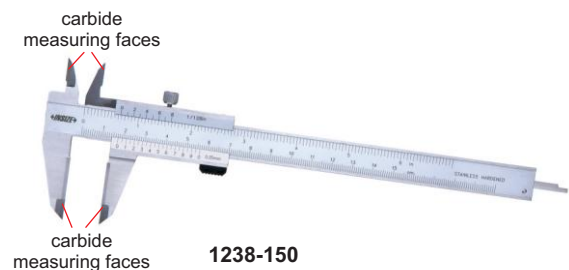

1238-150

Graduation 0.02mm/0.001" (mm)

Code	Range	Accuracy	L	a	b	c	d	(mm)
1238-1502	0-150mm/0-6"	±0.03mm	230	21	16.5	16	40	
1238-2002	0-200mm/0-8"	±0.03mm	295	24	19	16	50	
1238-3002	0-300mm/0-12"	±0.03mm	410	25	20	16	60	

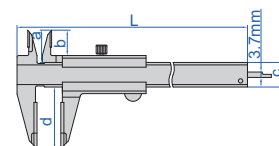

VERNIER CALIPERS

1217-3001

- With fine adjustment
- Made of stainless steel
- Satin chrome plated reading surface

Code	Range	Graduation	Accuracy	L
1217-2503	0-250mm	0.05mm	±0.05mm	360mm
1217-3001	0-300mm	0.02mm	±0.03mm	410mm

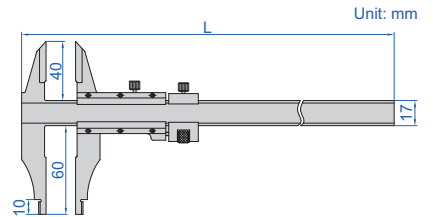
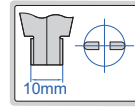
**ATTENTION:
NOT HARDENED**
PURE COPPER
VERNIER CALIPERS (ANTI MAGNETIC)

- Suitable for magnetic parts
- Made of pure copper

1224-150A

Code	Range	Graduation	Accuracy
1224-150A	0-150mm	0.02mm	±0.05mm
1224-1501A	0-150mm	0.05mm	±0.05mm

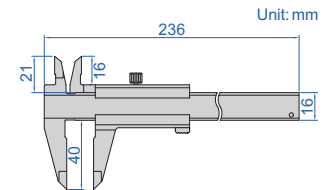
LEFT HAND VERNIER CALIPERS

- Designed for left handed users
- Made of stainless steel
- Satin chrome plated reading surface

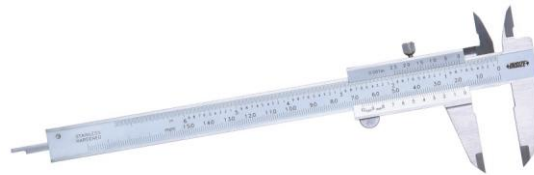
1239-1502

Code	Range	Graduation	Accuracy
1239-150	0-150mm/0-6"	0.05mm/1/128"	±0.05mm
1239-1503	0-150mm	0.05mm	±0.05mm
1239-1502	0-150mm/0-6"	0.02mm/0.001"	±0.03mm
1239-1501	0-150mm	0.02mm	±0.03mm

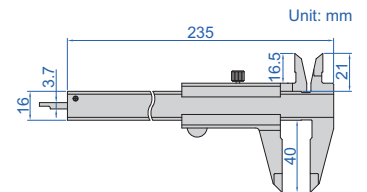
TEETH VERNIER CALIPER

- Used for teeth
- Made of stainless steel

1226-70

Code	Range	Graduation	Accuracy
1226-70	0-70mm	0.1mm	±0.1mm

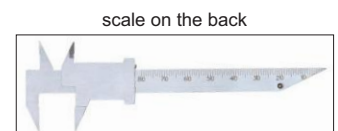
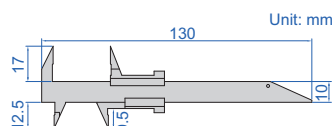

DIAL CALIPERS



1312-150A

INSPECTION
CERTIFICATE

SHOCK
PROOF

- Shockproof dial indicator
- Made of stainless steel

Dial indicator graduation: 0.02mm

Code	Range	Accuracy	Thumb roller	L	a	b	c	d	D	t
1312-150A*	0-150mm	±0.03mm	with	235	21	16.5	16	40	Ø39	6.5
1312-200A*	0-200mm	±0.03mm	with	288	24	19	16	48	Ø39	6.5
1312-300A*	0-300mm	±0.03mm	with	410	28	22	20	62	Ø44.5	7.5
1312-100AW*	0-100mm	±0.02mm	without	165	18	13	13	30	Ø32	6

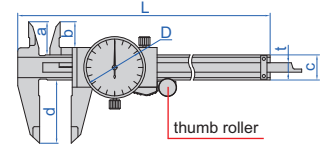

Dial indicator graduation: 0.01mm

Code	Range	Accuracy	Thumb roller	L	a	b	c	d	D	t
1311-150A*	0-150mm	±0.03mm	with	235	21	16.5	16	40	Ø39	6.5
1311-200A*	0-200mm	±0.03mm	with	288	24	19	16	48	Ø39	6.5
1311-300A*	0-300mm	±0.03mm	with	410	28	22	20	62	Ø44.5	7.5

*Supplied with manufacturer inspection certificate

DIAL CALIPERS WITH CARBIDE TIPPED JAWS

carbide measuring faces



carbide measuring faces 1339-150

INSPECTION
CERTIFICATE

SHOCK
PROOF

- Shockproof dial indicator
- Dial indicator graduation: 0.02mm
- Carbide tipped jaws for inside and outside measurements
- Made of stainless steel

Code	Range	Accuracy	L	a	b	c	d	D	t
1339-150*	0-150mm	±0.03mm	235	21	16.5	16	40	Ø39	6.5
1339-200*	0-200mm	±0.03mm	288	24	19	16	48	Ø39	6.5
1339-300*	0-300mm	±0.03mm	410	28	22	20	62	Ø44.5	7.5

*Supplied with manufacturer inspection certificate

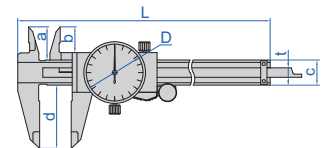

DIAL CALIPERS



1316-500

SHOCK
PROOF

- Shockproof dial indicator
- Dial indicator graduation: 0.02mm
- Made of stainless steel

Code	Range	Accuracy	a	c	d	e	L
1316-500	0-500mm	±0.05mm	18	21	90	20	650
1316-600	0-600mm	±0.05mm	18	21	90	20	750
1316-1000	0-1000mm	±0.07mm	24	28	150	20	1190
1316-1500	0-1500mm	±0.11mm	24	28	150	20	1690

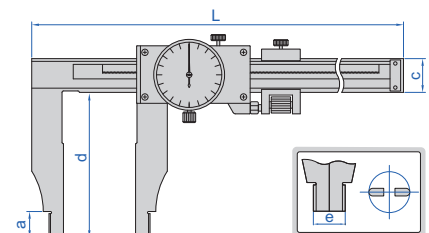

DATA
OUTPUT

POPULAR
MODEL

DIGITAL CALIPERS

2



1106-501

- Non waterproof
- Resolution: 0.01mm/0.0005"
- Button function: on/off, zero, mm/inch, ABS, data preset
- Battery CR2032
- Made of stainless steel
- Optional accessory: accessory set for large digital calipers (code **6145-500/6146-500B**, for calipers with c=24mm)

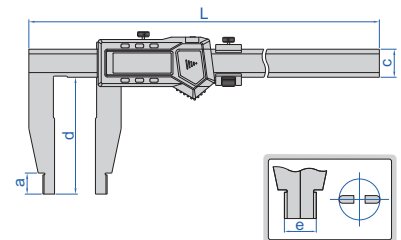

With data interface

(mm)

Code	Range	Accuracy	a	c	d	e	L	Data output cable (optional)
1106-301	0-300mm/0-12"	±0.05mm	18	24	100	20	420	7315-22 (receiver is needed) page 5, 7214-22 page 11, 7302-22 page 20
1106-302	0-300mm/0-12"	±0.05mm	18	24	150	20	475	
1106-451	0-450mm/0-18"	±0.05mm	18	24	100	20	625	
1106-501	0-500mm/0-20"	±0.05mm	18	24	100	20	675	
1106-502	0-500mm/0-20"	±0.06mm	18	24	150	20	675	
1106-503	0-500mm/0-20"	±0.06mm	24	31	200	20	675	7315-20B (receiver is needed), 7302-SPC1A
1106-505	0-500mm/0-20"	±0.08mm	24	42	300	20	675	
1106-601	0-600mm/0-24"	±0.05mm	18	24	100	20	770	7315-22 (receiver is needed) page 5, 7214-22 page 11, 7302-22 page 20
1106-602	0-600mm/0-24"	±0.06mm	18	24	150	20	770	
1106-603	0-600mm/0-24"	±0.06mm	24	31	200	20	825	
1106-802	0-800mm/0-32"	±0.07mm	24	31	150	20	1025	
1106-1002	0-1000mm/0-40"	±0.08mm	24	31	150	20	1220	
1106-1003	0-1000mm/0-40"	±0.08mm	24	31	200	20	1220	7315-20B (receiver is needed), 7302-SPC1A
1106-1005	0-1000mm/0-40"	±0.10mm	24	42	300	20	1220	
1106-1502	0-1500mm/0-60"	±0.11mm	24	42	150	20	1780	
1106-1503	0-1500mm/0-60"	±0.12mm	24	42	200	20	1780	
1106-2002	0-2000mm/0-80"	±0.14mm	24	42	150	20	2290	
1106-2003	0-2000mm/0-80"	±0.14mm	24	42	200	20	2290	
1106-2502	0-2500mm/0-100"	±0.22mm	24	42	150	20	2800	
1106-3002	0-3000mm/0-120"	±0.26mm	24	42	150	20	3300	

Built-in wireless (receiver code 7315-2/3/6/7/8/9 is needed)

Code	Range	Accuracy	a	c	d	e	L
1106-301WL	0-300mm/0-12"	±0.05mm	18mm	24mm	100mm	20mm	420mm
1106-302WL	0-300mm/0-12"	±0.05mm	18mm	24mm	150mm	20mm	420mm
1106-451WL	0-450mm/0-18"	±0.05mm	18mm	24mm	100mm	20mm	625mm
1106-501WL	0-500mm/0-20"	±0.05mm	18mm	24mm	100mm	20mm	675mm
1106-502WL	0-500mm/0-20"	±0.06mm	18mm	24mm	150mm	20mm	675mm
1106-601WL	0-600mm/0-24"	±0.05mm	18mm	24mm	100mm	20mm	770mm
1106-602WL	0-600mm/0-24"	±0.06mm	18mm	24mm	150mm	20mm	770mm

DIGITAL CALIPERS

DATA OUTPUT



1117-501

- Non waterproof
- Resolution: 0.01mm/0.0005"
- Button function: on/off, zero, mm/inch, ABS, data preset
- Battery CR2032
- Made of stainless steel
- Optional accessory: accessory set for large digital calipers (code 6145-500/6146-500B, for calipers with c=24mm)

With data interface (optional data output cable: code 7315-22 receiver is needed page 5, 7214-22 page 11, 7302-22 page 20)

Code	Range	Accuracy	a	b	c	d	e	L
1117-301	0-300mm/0-12"	±0.05mm	18mm	56mm	24mm	100mm	20mm	420mm
1117-501	0-500mm/0-20"	±0.05mm	18mm	56mm	24mm	100mm	20mm	675mm
1117-502	0-500mm/0-20"	±0.06mm	24mm	56mm	24mm	150mm	20mm	675mm
1117-601	0-600mm/0-24"	±0.05mm	18mm	56mm	24mm	100mm	20mm	770mm
1117-802	0-800mm/0-32"	±0.07mm	24mm	67mm	31mm	150mm	20mm	1025mm
1117-1002	0-1000mm/0-40"	±0.08mm	24mm	67mm	31mm	150mm	20mm	1220mm

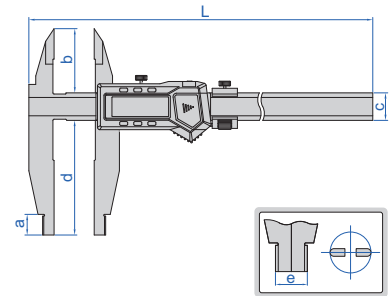

Built-in wireless (receiver code 7315-2/3/6/7/8/9 is needed)

Code	Range	Accuracy	a	b	c	d	e	L
1117-301WL	0-300mm/0-12"	±0.05mm	18mm	56mm	24mm	100mm	20mm	420mm
1117-501WL	0-500mm/0-20"	±0.05mm	18mm	56mm	24mm	100mm	20mm	675mm
1117-502WL	0-500mm/0-20"	±0.06mm	24mm	56mm	24mm	150mm	20mm	675mm
1117-601WL	0-600mm/0-24"	±0.05mm	18mm	56mm	24mm	100mm	20mm	770mm

DIGITAL CALIPERS

DATA OUTPUT



1136-501

- Non waterproof
- Resolution: 0.01mm/0.0005"
- Button function: on/off, zero, mm/inch, ABS, data preset
- Battery CR2032
- Made of stainless steel
- Optional accessory: accessory set for large digital calipers (code 6145-500/6146-500B, for calipers with c=24mm)

With data interface (optional data output cable: code 7315-22 receiver is needed page 5, 7214-22 page 11, 7302-22 page 20, for calipers with c=24mm or 31mm)

Code	Range	Accuracy	a	b	c	d	L
1136-301	0-300mm/0-12"	±0.05mm	18	45	24	100	420
1136-451	0-450mm/0-18"	±0.05mm	18	45	24	100	625
1136-501	0-500mm/0-20"	±0.05mm	18	45	24	100	675
1136-502	0-500mm/0-20"	±0.06mm	18	45	24	150	675
1136-503	0-500mm/0-20"	±0.06mm	24	60	31	200	675
1136-601	0-600mm/0-24"	±0.05mm	18	45	24	100	770
1136-1002	0-1000mm/0-40"	±0.08mm	24	60	31	150	1220
1136-1502	0-1500mm/0-60"	±0.11mm	24	60	42	150	1780
1136-2002	0-2000mm/0-80"	±0.14mm	24	60	42	150	2290

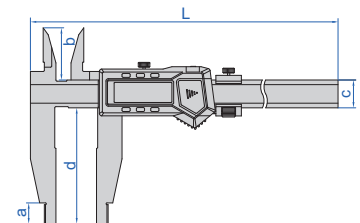
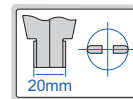

Built-in wireless (receiver code 7315-2/3/6/7/8/9 is needed)

Code	Range	Accuracy	a	b	c	d	L
1136-301WL	0-300mm/0-12"	±0.05mm	18	45	24	100	420
1136-451WL	0-450mm/0-18"	±0.05mm	18	45	24	100	625
1136-501WL	0-500mm/0-20"	±0.05mm	18	45	24	100	675
1136-502WL	0-500mm/0-20"	±0.06mm	18	45	24	150	675
1136-601WL	0-600mm/0-24"	±0.05mm	18	45	24	100	770

DATA
OUTPUT

DIGITAL CALIPERS

1135-601

- Non waterproof
- Resolution: 0.01mm/0.0005"
- Button function: on/off, zero, mm/inch, ABS, data preset
- Battery CR2032
- Made of stainless steel

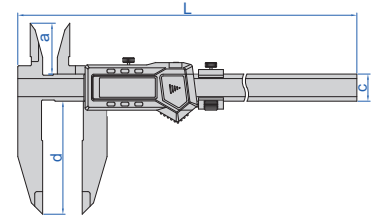

With data interface (optional data output cable:
code 7315-22 receiver is needed page 5,
7214-22 page 11, 7302-22 page 20)

Code	Range	Accuracy	a	c	d	L
1135-451	0-450mm/0-18"	±0.05mm	45	24	100	625
1135-601	0-600mm/0-24"	±0.05mm	45	24	100	770
1135-1002	0-1000mm/0-40"	±0.08mm	60	31	150	1220

Built-in wireless
(receiver code 7315-2/3/6/7/8/9 is needed)

Code	Range	Accuracy	a	c	d	L
1135-451WL	0-450mm/0-18"	±0.05mm	45	24	100	625
1135-601WL	0-600mm/0-24"	±0.05mm	45	24	100	770

VERNIER CALIPERS (SOLID TYPE)

- With fine adjustment
- Made of stainless steel
- Satin chrome plated reading surface

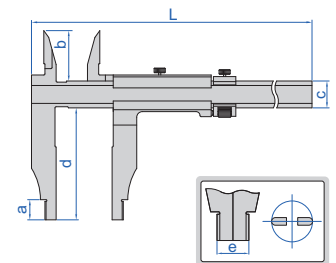

1236-521

 solid type
(without screw)

Graduation 0.05mm/1/128" (mm)

Code	Range	Accuracy	a	b	c	d	e	L
1236-394	0-300mm/0-12"	±0.07mm	12	38	20	90	10	450
1236-514	0-500mm/0-20"	±0.07mm	18	45	24	100	20	670
1236-524	0-500mm/0-20"	±0.08mm	18	45	24	150	20	670
1236-614	0-600mm/0-24"	±0.08mm	18	45	24	100	20	770
1236-824	0-800mm/0-32"	±0.09mm	24	60	31	150	20	1030
1236-1024	0-1000mm/0-40"	±0.12mm	24	60	31	150	20	1230

Graduation 0.02mm (mm)

Code	Range	Accuracy	a	b	c	d	e	L
1236-511	0-500mm	±0.05mm	18	45	24	100	20	670
1236-521	0-500mm	±0.06mm	18	45	24	150	20	670
1236-1021	0-1000mm	±0.08mm	24	60	31	150	20	1230

VERNIER CALIPERS (SOLID TYPE)

- Graduation 0.05mm/1/128"
- With fine adjustment
- Made of stainless steel
- Satin chrome plated reading surface

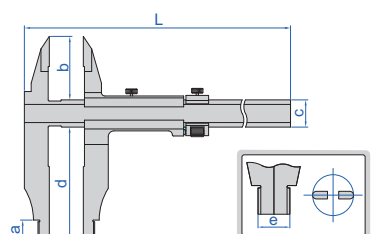

1207-514

 solid type
(without screw)

(mm)

Code	Range	Accuracy	a	b	c	d	e	L
1207-394	0-300mm/0-12"	±0.07mm	12	40	20	90	10	440
1207-514	0-500mm/0-20"	±0.07mm	18	56	24	100	20	670
1207-524	0-500mm/0-20"	±0.08mm	18	56	24	150	20	670
1207-824	0-800mm/0-32"	±0.09mm	24	67	31	150	20	930
1207-1024	0-1000mm/0-40"	±0.12mm	24	67	31	150	20	1230

VERNIER CALIPERS (SOLID TYPE)

2

- With fine adjustment
- Made of stainless steel
- Satin chrome plated reading surface



1208-511

Graduation 0.05mm/1/128"

(mm)

Code	Range	Accuracy	a	c	d	e	L
1208-214	0-200mm/0-8"	±0.06mm	10	20	100	10	330
1208-394	0-300mm/0-12"	±0.07mm	10	20	90	10	410
1208-324	0-300mm/0-12"	±0.07mm	18	24	150	20	410
1208-524	0-500mm/0-20"	±0.08mm	18	24	150	20	670
1208-614	0-600mm/0-24"	±0.08mm	18	24	100	20	770
1208-624	0-600mm/0-24"	±0.09mm	18	24	150	20	770
1208-824	0-800mm/0-32"	±0.09mm	24	31	150	20	1030
1208-1024	0-1000mm/0-40"	±0.12mm	24	31	150	20	1230
1208-1524	0-1500mm/0-60"	±0.16mm	24	42	150	20	1820
1208-2024	0-2000mm/0-80"	±0.20mm	24	42	150	20	2330

solid type
(without screw)



Graduation 0.02mm

(mm)

Code	Range	Accuracy	a	c	d	e	L
1208-511	0-500mm	±0.05mm	18	24	100	20	670
1208-521	0-500mm	±0.06mm	18	24	150	20	670
1208-1021	0-1000mm	±0.08mm	24	31	150	20	1230
1208-1521	0-1500mm	±0.11mm	24	42	150	20	1820

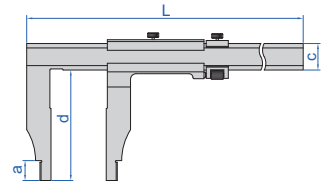
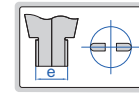

VERNIER CALIPERS (SOLID TYPE)

- With fine adjustment
- Made of stainless steel
- Satin chrome plated reading surface

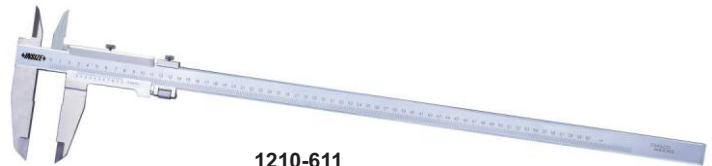

1210-611

Graduation 0.05mm/1/128"

(mm)

Code	Range	Accuracy	a	c	d	L
1210-614	0-600mm/0-24"	±0.08mm	45	24	100	770
1210-1024	0-1000mm/0-40"	±0.12mm	60	31	150	1230

Graduation 0.02mm

(mm)

Code	Range	Accuracy	a	c	d	L
1210-611	0-600mm	±0.05mm	45	24	100	770
1210-1021	0-1000mm	±0.08mm	60	31	150	1230

solid type
(without screw)

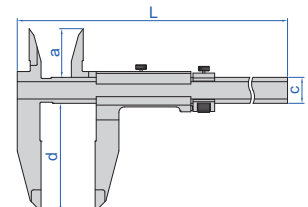

POPULAR MODEL

VERNIER CALIPERS (SEPARATE TYPE)

2

- With fine adjustment
- Made of stainless steel
- Satin chrome plated reading surface



1214-500

Graduation 0.02mm/0.001" (mm)

Code	Range	Accuracy	a	c	d	e	L
1214-300	0-300mm/0-12"	±0.05mm	10	20	75	10	410
1214-450	0-450mm/0-18"	±0.05mm	18	24	100	20	620
1214-500	0-500mm/0-20"	±0.05mm	18	24	100	20	670
1214-600	0-600mm/0-24"	±0.05mm	18	24	100	20	770
1214-1000	0-1000mm/0-40"	±0.08mm	24	32	140	20	1216
1214-1500	0-1500mm/0-60"	±0.12mm	24	42	200	20	1830
1214-2000	0-2000mm/0-80"	±0.14mm	24	42	200	20	2320

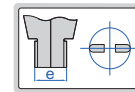
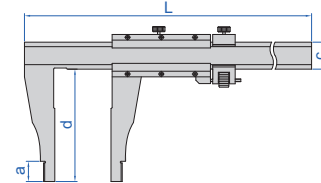

separate type
(with screws)



Graduation 0.05mm/1/128" (mm)

Code	Range	Accuracy	a	c	d	e	L
1214-6004	0-600mm/0-24"	±0.08mm	18	24	100	20	770
1214-1004	0-1000mm/0-40"	±0.12mm	24	32	140	20	1216

LONG JAW VERNIER CALIPERS (SEPARATE TYPE)

- With fine adjustment
- Made of stainless steel
- Satin chrome plated reading surface



1215-1032

Graduation 0.02mm/0.001" (mm)

Code	Range	Accuracy	a	c	d	e	L
1215-392	0-300mm/0-12"	±0.05mm	10	17	90	10	410
1215-322	0-300mm/0-12"	±0.05mm	18	24	150	20	470
1215-522	0-500mm/0-20"	±0.06mm	18	24	150	20	670
1215-532	0-500mm/0-20"	±0.06mm	18	24	200	20	670
1215-622	0-600mm/0-24"	±0.06mm	18	24	150	20	770
1215-642	0-600mm/0-24"	±0.08mm	24	32	250	20	870
1215-822	0-800mm/0-32"	±0.07mm	24	32	150	20	1020
1215-832	0-800mm/0-32"	±0.07mm	24	32	200	20	1020
1215-1032	0-1000mm/0-40"	±0.08mm	24	32	200	20	1220
1215-1052	0-1000mm/0-40"	±0.11mm	24	42	300	20	1330
1215-3052	0-3000mm/0-120"	±0.26mm	24	50	300	20	3360

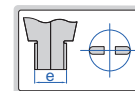
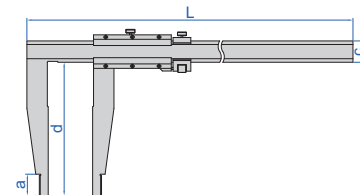

separate type
(with screws)

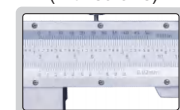

Graduation 0.05mm/1/128" (mm)

Code	Range	Accuracy	a	c	d	e	L
1215-524	0-500mm/0-20"	±0.08mm	18	24	150	20	670
1215-1034	0-1000mm/0-40"	±0.12mm	24	32	200	20	1330

CALIPER INSPECTION GAUGE BLOCK AND RING GAUGE SETS

REFER TO PAGE 355
FOR DETAILS

2



4176-30

CALIPER/HEIGHT GAUGE CHECKERS

REFER TO PAGE 360
FOR DETAILS



horizontal use



vertical use

6884-300

CALIPER END GRINDING MACHINE CODE 6309



- Used for grinding the depth measuring surface of the end of calipers

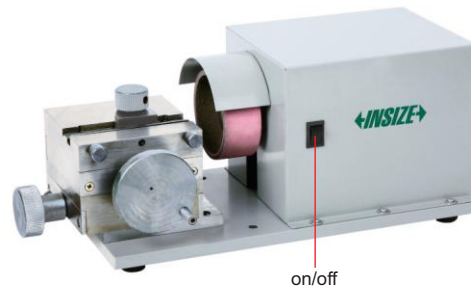

on/off

application

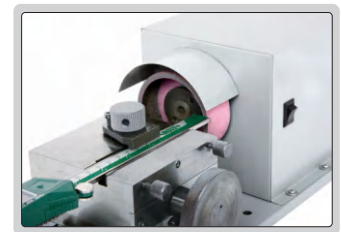

SPECIFICATION

Power supply	220V, 50/60Hz
Dimension (L×W×H)	370×200×160mm
Weight	15kg

CALIPER/MICROMETER LAPPING MACHINE CODE 6318

REFER TO PAGE 191
FOR DETAILS



lapping measuring surfaces of
caliper lower jaws



- For lapping measuring surfaces of caliper lower jaws

DEPTH BASE ATTACHMENTS



6140



6140-16B

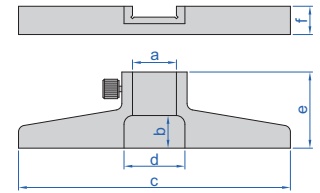
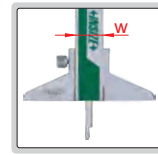

2

(mm)

Code	a	b	c	d	e	f
6140	16.5	9	75	18	30	6
6140-300A	20	15	125	22	34	9
6140-16B	16	12.5	75	24.5	30	11
6140-300B	20	15	125	28	35	13

- To increase the stability of depth measurement
- Made of stainless steel

Application

Code	Type	Application
6140	narrow base (f=6mm)	suitable for 1195/1118/1113/1108/1103/1114/1109/1130/1193/1110 series digital calipers with beam width (w) 16mm
6140-300A	narrow base (f=9mm)	suitable for 1196 series digital calipers with beam width (w) 20mm
6140-16B	wide base (f=11mm), high stability	suitable for 1195/1118/1113/1108/1103/1114/1109/1130/1193/1110 series digital calipers and 1312/1311/1339 series dial calipers with beam width (w) 16mm
6140-300B	wide base (f=13), high stability	suitable for 1196 series digital calipers and 1312/1311/1339 series dial calipers with beam width (w) 20mm

ACCESSORY SET FOR DIGITAL CALIPERS CODE 6144



16-20mm

measuring internal groove diameter (h≤3.5mm)

measuring center distance

0-6mm

spherical points for groove diameter (inside hole) measurement

0-6mm

flat points for external groove diameter measurement

6144

Unit: mm

Ø9.5
3.7
50
Ø3

Unit: mm

2-M3x0.5
Ø2
3
M3.0x0.5

Unit: mm

25
Ø3
Ø10±0.005
0.8

disk points (stainless steel)

Unit: mm

Ø10±0.005
Ø3
10
60°

conical points (stainless steel)

Unit: mm

Ø2
12
SR2

spherical/flat points (stainless steel)

- Suitable for 0-150mm/0-6" and 0-200mm/0-8" digital calipers (thickness of lower jaws≤3.7mm)

Code
6144

**ACCESSORY SET FOR LARGE DIGITAL CALIPERS
CODE 6145-500**



6145-500

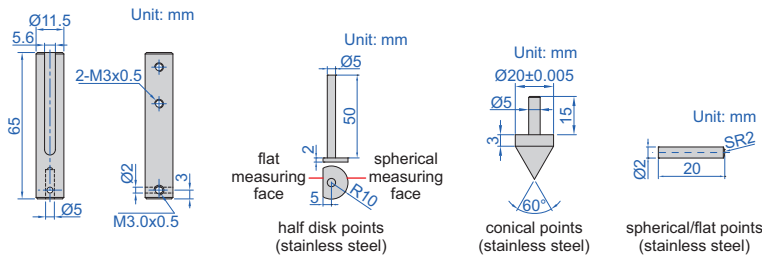

■ Suitable for 0-500mm/0-20" and 0-600mm/0-24" digital calipers (thickness of lower jaws ≤ 5.6mm)

Code
6145-500

**ACCESSORY SET FOR LARGE DIGITAL CALIPERS (WITH SIDE POINTS)
CODE 6146-500B**



6146-500B

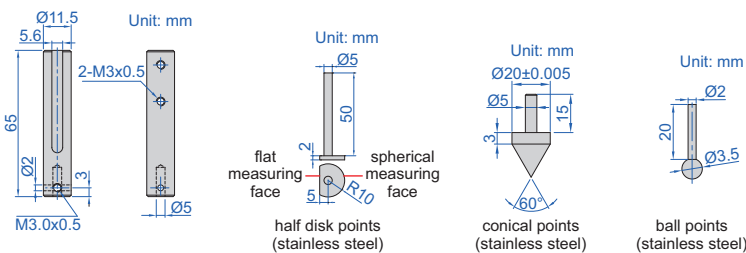

■ Suitable for 0-500mm/0-20" and 0-600mm/0-24" digital calipers (thickness of lower jaws ≤ 5.6mm)

Code
6146-500B

UNIVERSAL CALIPERS



DATA OUTPUT



1125-600

- Non waterproof
- Buttons: on/off, set, mm/inch, ABS, preset (+, -)
- Automatic power off, move the digital unit to turn on power
- Battery CR2032
- Made of stainless steel

With data interface (optional data output cable: code 7315-22 receiver is needed page 5, 7214-22 page 11, 7302-22 page 20)

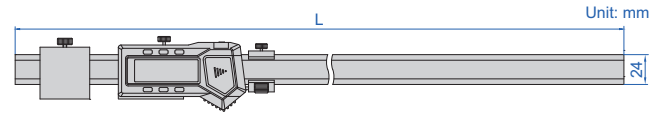

Code	Range *	Resolution	Accuracy	L
1125-600	0-600mm/0-24"	0.01mm/0.0005"	±0.05mm	778mm
1125-1000	0-1000mm/0-40"	0.01mm/0.0005"	±0.07mm	1205mm

Built-in wireless (receiver code 7315-2/3/6/7/8/9 is needed)

Code	Range *	Resolution	Accuracy	L
1125-600WL	0-600mm/0-24"	0.01mm/0.0005"	±0.05mm	778mm
1125-1000WL	0-1000mm/0-40"	0.01mm/0.0005"	±0.07mm	1205mm

*The range changes according to different points

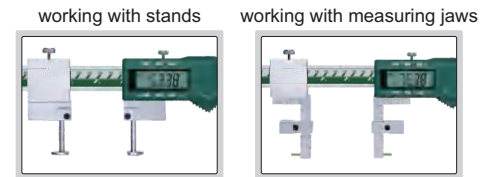

Half disk points (included)

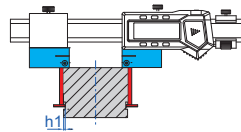
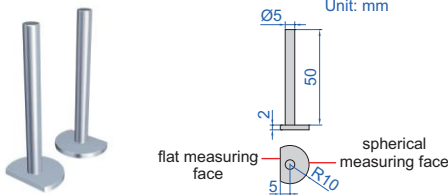

measuring external groove diameter with flat measuring face (depth $h1 \leq 2.5\text{mm}$)

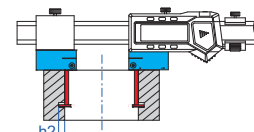

measuring internal groove diameter with spherical measuring face (depth $h2 \leq 7.5\text{mm}$)

Conical points (optional)

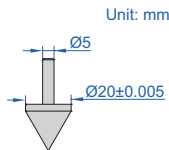

Code
1125-T101

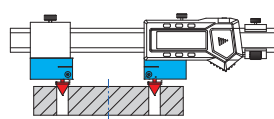

measuring center distance

Round shoulder points (optional)

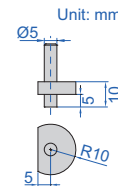

Code
1125-T102

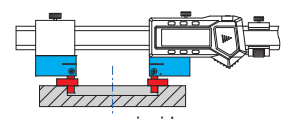

measure inside diameter of shallow hole

Flat shoulder points (optional)

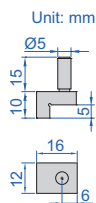

Code
1125-T103

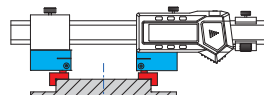

measure outside diameter of low boss

Spherical points (included)

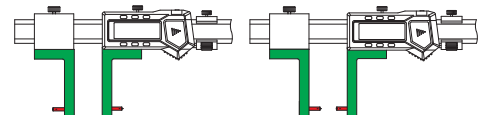
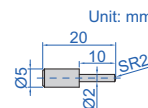

Point sleeve (optional)

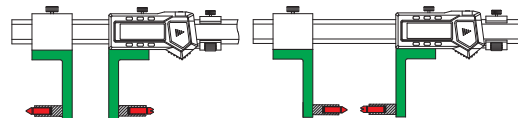

working with multifunctional points, ball points and screw thread points

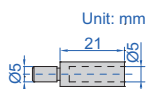

Code
1125-T104

Stands (included)

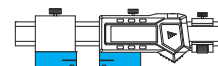
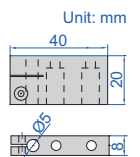

To be continued

Continued from previous page

Depth stop (included)

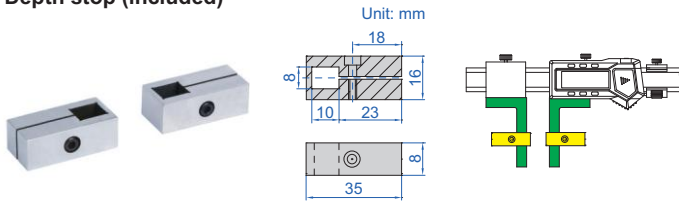

Measuring jaws (included)

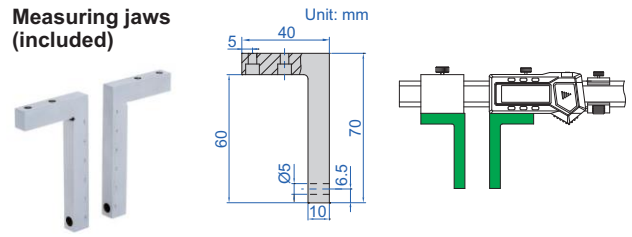

Multifunctional points 7392* (optional, page 52)



*It is necessary to use point sleeve (code 1125-T104) for these points

Ball points 7391* (optional, page 52)



Screw thread points 7381*, 7321* (optional, page 52)



DIGITAL CALIPERS WITH INTERCHANGEABLE POINTS

DATA OUTPUT



1526-200

- Non waterproof
- Supplied with 3 pairs of points and zero setting block for external measurement
- Resolution: 0.01mm/0.0005"
- Buttons: on/off, set, mm/inch, preset (+, -)
- Automatic power off, move the digital unit to turn on power
- Battery CR2032
- Made of stainless steel
- Optional accessory: points



short spherical points (included) Unit: mm



long spherical/flat points (included) Unit: mm



spherical blade points (included) Unit: mm

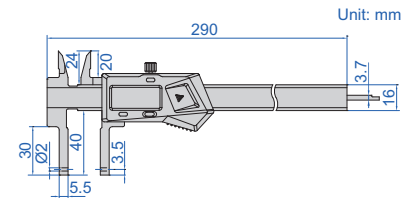

With data interface

Code	Data output cable (optional)
1526-200	7315-25 (receiver is needed) page 5, 7214-25 page 11, 7302-21 page 20

Built-in wireless

Code	Receiver (optional)
1526-200WL	code 7315-2/3/6/7/8/9

Point	Range	Accuracy	Application
short spherical points	12-212mm/0.5-8.5" (internal)	±0.03mm	for grooves inside small hole
long spherical/flat points	24-224mm/1-8.8" (internal) 0-187mm/0-7.5" (external)	±0.03mm	spherical points for grooves inside hole flat points for external grooves
spherical blade points	24-224mm/1-8.8" (internal) 0-187mm/0-7.5" (external)	±0.03mm	for narrow grooves inside hole

zero setting block for external measurement (included)



install points

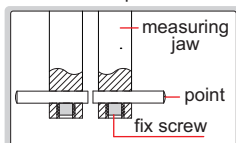

measure internal and external grooves

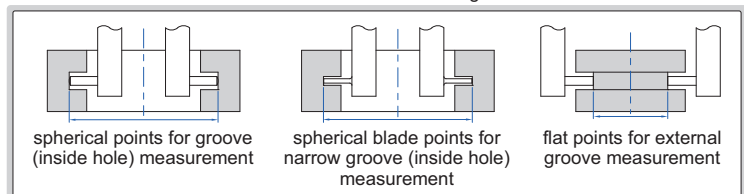

To be continued

Continued from previous page

Depth stop (optional)

Code
6143

6143

for external groove measurement

for internal groove measurement

Point sleeve (optional)

1526-T101

installation

Code
1526-T101

Ball points (optional)

7391-T5

* It is necessary to use point sleeve (code **1526-T101**) for these points

** Range of **1526-200** and **1526-200WL** after installing the points and point sleeve

Code	Ball dia. (D)	Range**
7391-T3*	SØ2.0mm	75-275mm/3.0-10.8" (internal) 0-146mm/0-5.7" (external)
7391-T4*	SØ2.5mm	76-276mm/3.0-10.8" (internal) 0-145mm/0-5.7" (external)
7391-T5*	SØ3.0mm	77-277mm/3.0-10.9" (internal) 0-144mm/0-5.6" (external)
7391-T6*	SØ3.5mm	78-278mm/3.1-10.9" (internal) 0-143mm/0-5.6" (external)
7391-T7*	SØ4.0mm	79-279mm/3.1-10.9" (internal) 0-142mm/0-5.5" (external)
7391-T8*	SØ4.5mm	80-280mm/3.2-11.0" (internal) 0-141mm/0-5.5" (external)
7391-T9*	SØ5.0mm	81-281mm/3.2-11.0" (internal) 0-140mm/0-5.5" (external)
7391-T10*	SØ6.0mm	83-283mm/3.3-11.1" (internal) 0-138mm/0-5.4" (external)

Multifunctional points (optional)

7392-T1

7392-T4

7392-T7

7392-T2

7392-T5

7392-T8

7392-T3

7392-T6

7392-T9

Code	Type
7392-T1*	flat
7392-T2*	spherical
7392-T3*	spline
7392-T4*	disk
7392-T5*	blade
7392-T6*	knife-edge point
7392-T7*	point
7392-T8*	knife-edge point
7392-T9*	point

* It is necessary to use point sleeve (code **1526-T101**) for these points

Range**
66-266mm/2.6-10.5" (internal), 0-155mm/0-6.1" (external)

** Range of **1526-200** and **1526-200WL** after installing the points and point sleeve

Screw thread points (optional)

7321-T16

7381-T11

Internal thread (60° thread angle)

Code	Pitch
7321-T11*	0.4-0.5mm/64-48TPI
7321-T12*	0.6-0.9mm/44-28TPI
7321-T13*	1-1.75mm/24-14TPI
7321-T14*	2-3mm/13-9TPI
7321-T15*	3.5-5mm/8-5TPI
7321-T16*	5.5-7mm/4.5-3.5TPI
7321-T1S*	6 pairs/set, including all above points

External thread (60° thread angle)

Code	Pitch
7381-T11*	0.4-0.5mm/64-48TPI
7381-T12*	0.6-0.9mm/44-28TPI
7381-T13*	1-1.75mm/24-14TPI
7381-T14*	2-3mm/13-9TPI
7381-T15*	3.5-5mm/8-5TPI
7381-T16*	5.5-7mm/4.5-3.5TPI
7381-TS*	6 pairs/set, including all above points

Range**
66-266mm/2.6-10.5" (internal)
0-155mm/0-6.1" (external)

** Range of **1526-200** and **1526-200WL** after installing the points and point sleeve

* It is necessary to use point sleeve (code **1526-T101**) for these points

DIGITAL CALIPERS WITH INTERCHANGEABLE POINTS

DATA
OUTPUT



2

short spherical/flat points (included) Unit: mm

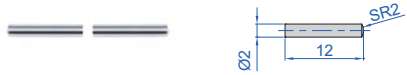

long spherical/flat points (included) Unit: mm



short spherical blade points (included) Unit: mm

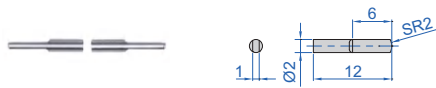

long spherical blade points (included) Unit: mm

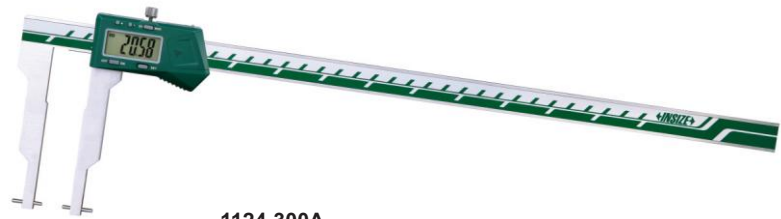
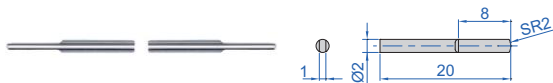

1124-300A

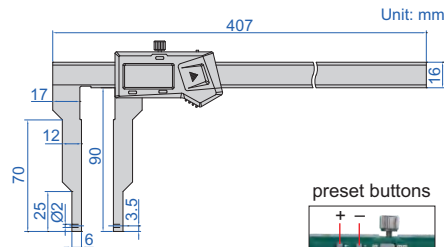

preset buttons



zero setting block for external measurement (included)



- Non waterproof
- Supplied with 4 pairs of points and zero setting block for external measurement
- Resolution: 0.01mm/0.0005"
- Buttons: on/off, set, mm/inch, preset (+, -)
- Automatic power off, move the digital unit to turn on power
- Battery CR2032
- Made of stainless steel
- Optional accessory: points (code 1526-T101, 7392, 7391, 7381, 7321), depth stop (code 6143)

install points

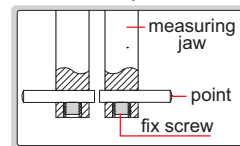

depth stop 6143 (optional)



measure internal and external grooves

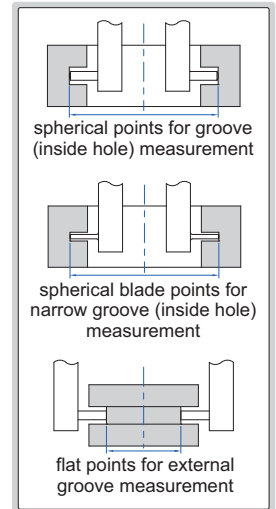

With data interface

Code	Data output cable (optional)
1124-300A	7315-25 (receiver is needed) page 5, 7214-25 page 11, 7302-21 page 20

Built-in wireless

Code	Receiver (optional)
1124-300AWL	code 7315-2/3/6/7/8/9

Point	Range	Accuracy	Application
short spherical/flat points	24-324mm/1-12.7" (internal) 0-288mm/0-11.3" (external)	±0.04mm	spherical points for grooves inside hole (small hole) flat points for external grooves
long spherical/flat points	40-340mm/1.5-13.3" (internal) 0-272mm/0-10.7" (external)	±0.04mm	spherical points for grooves inside hole (large hole) flat points for external grooves
short spherical blade points	24-324mm/1-12.7" (internal) 0-288mm/0-11.3" (external)	±0.04mm	for narrow grooves inside hole (small hole)
long spherical blade points	40-340mm/1.5-13.3" (internal) 0-272mm/0-10.7" (external)	±0.04mm	for narrow grooves inside hole (large hole)

Multifunctional points 7392* (optional, page 52)

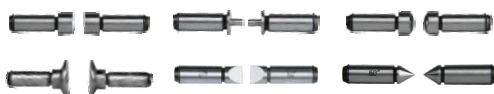

Ball points 7391* (optional, page 52)



Screw thread points 7381*, 7321* (optional, page 52)



* It is necessary to use point sleeve (code 1526-T101) for these points

DATA
OUTPUT

VARIOUS POINTS ARE
AVAILABLE (PAGE 272-276)

DIGITAL CALIPERS WITH INTERCHANGEABLE POINTS



2

preset buttons

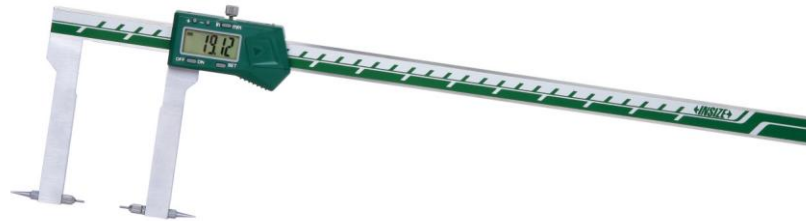

1530-300

- Non waterproof
- Supplied with 4 pairs of points and zero setting block for external measurement
- Resolution: 0.01mm/0.0005"
- Buttons: on/off, set, mm/inch, preset (+, -)
- Automatic power off, move the digital unit to turn on power
- Battery CR2032
- Made of stainless steel
- Optional accessory: points (page 272~276), depth stop (code 6143)

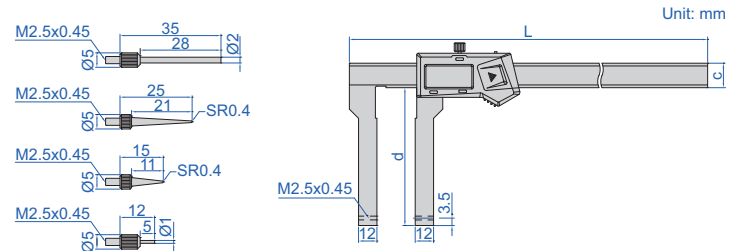

measure internal and external grooves

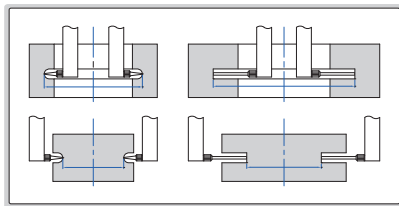

4 pairs of points (included)

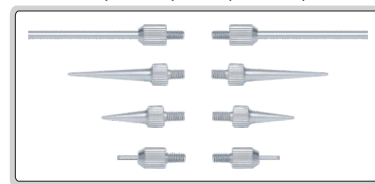

zero setting block for
external measurement
(included)



Code	Range*	Accuracy	L	d	c	Data output cable (optional)
1530-300	0-300mm/0-12"	±0.06mm	407mm	90mm	16mm	7315-25 (receiver is needed) page 5, 7214-25 page 11, 7302-21 page 20
1530-500	0-500mm/0-20"	±0.08mm	740mm	100mm	24mm	7315-22 (receiver is needed) page 5, 7214-22 page 11, 7302-22 page 20

Built-in wireless
(receiver code 7315-2/3/6/7/8/9 is needed)

Code	Range*	Accuracy	L	d	c
1530-300WL	0-300mm/0-12"	±0.06mm	407mm	90mm	16mm
1530-500WL	0-500mm/0-20"	±0.08mm	740mm	100mm	24mm

*For different points, the measuring range changes accordingly

depth stop 6143 (optional)



DIGITAL INSIDE GROOVE CALIPERS

2

preset buttons



1520-150



1520-150P

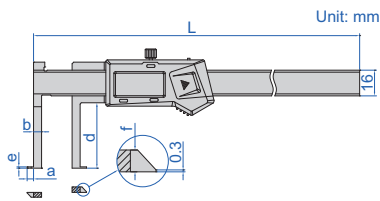

type A

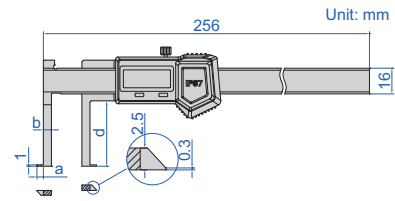

type B

- Measure diameter of grooves inside small bores
- Resolution: 0.01mm/0.0005"
- Buttons type A: on/off, set, mm/inch, preset (+, -), type B: on/off, zero, mm/inch, ABS/REL, hold
- Battery CR2032
- Made of stainless steel
- Optional accessory: depth stop (code **6143**)

depth stop 6143
(optional)

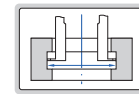

Non waterproof, with data interface

(optional data output cable: code 7315-25 receiver is needed page 5, 7214-25 page 11, 7302-21 page 20)

Code	Range	Type	Accuracy	L	a	b	d	e	f
1520-150	11-150mm/0.43-6"	A	±0.04mm	236mm	3.5mm	5mm	41mm	1mm	2.5mm
1520-200	16-200mm/0.63-8"	A	±0.04mm	285mm	5mm	7mm	41mm	1mm	3mm
1520-300	20-300mm/0.79-12"	A	±0.05mm	398mm	7.5mm	9mm	62mm	2mm	4mm

Non waterproof, built-in wireless (receiver code 7315-2/3/6/7/8/9 is needed)

Code	Range	Type	Accuracy	L	a	b	d	e	f
1520-150WL	11-150mm/0.43-6"	A	±0.04mm	236mm	3.5mm	5mm	41mm	1mm	2.5mm
1520-200WL	16-200mm/0.63-8"	A	±0.04mm	285mm	5mm	7mm	41mm	1mm	3mm
1520-300WL	20-300mm/0.79-12"	A	±0.05mm	398mm	7.5mm	9mm	62mm	2mm	4mm

IP67 dust/waterproof, no automatic power off, set zero after power on each time, without data interface

Code	Range	Type	Accuracy	a	b	d
1520-150P	14-150mm/0.56-6"	B	±0.04mm	5mm	7mm	30mm
1520-1501P	8-150mm/0.31-6"	B	±0.04mm	2mm	4mm	40mm

DATA
OUTPUT

DIGITAL INSIDE POINT CALIPERS

 depth stop 6143
(optional)

preset buttons

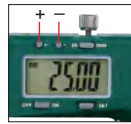
 1121-150A
type A

 1121-150B
type B

- Non waterproof
- Measure groove diameter
- Resolution: 0.01mm/0.0005"
- Buttons type A: on/off, set, mm/inch, preset (+, -)
type B: on/off, zero, mm/inch
- Automatic power off, move the digital unit to turn on power
- Battery CR2032
- Data output
- Made of stainless steel
- Optional accessory: depth stop
(code 6143, for calipers with c=16mm)

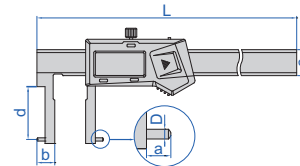
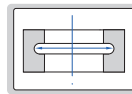

Preset (no need to add the width of the jaws on the reading), with data interface

(mm)

Code	Range	Type	Accuracy	L	a	b	c	d	D	Data output cable (optional)
1121-150A	24-150mm/0.94-6"	A	±0.04mm	250	5	12	16	28	Ø2	7315-25 (receiver is needed) page 5, 7214-25 page 11, 7302-21 page 20
1121-1501	35-150mm/1.38-6"	A	±0.05mm	250	6	17.5	16	60	Ø2	
1121-200A	25-200mm/0.98-8"	A	±0.04mm	310	5	12.5	16	37	Ø2	
1121-2001	40-200mm/1.57-8"	A	±0.05mm	310	7	20	16	70	Ø3	
1121-300A	30-300mm/1.18-12"	A	±0.07mm	410	5	15	16	50	Ø2	
1121-3001A	50-300mm/1.97-12"	A	±0.07mm	410	8	25	16	77	Ø3	7315-22 (receiver is needed) page 5, 7214-22 page 11, 7302-22 page 20
1121-500A	40-500mm/1.57-20"	A	±0.07mm	680	5	20	24	90	Ø3	
1121-5001	60-500mm/2.36-20"	A	±0.08mm	680	10	30	24	120	Ø3	
1121-5002	80-500mm/3.15-20"	A	±0.08mm	680	16	40	24	150	Ø3	

Preset (no need to add the width of the jaws on the reading), built-in wireless (receiver code 7315-2/3/6/7/8/9 is needed)

Code	Range	Type	Accuracy	L	a	b	c	d	D
1121-150AWL	24-150mm/0.94-6"	A	±0.04mm	250mm	5mm	12mm	16mm	28mm	Ø2mm
1121-1501WL	35-150mm/1.38-6"	A	±0.05mm	250mm	6mm	17.5mm	16mm	60mm	Ø2mm
1121-200AWL	25-200mm/0.98-8"	A	±0.04mm	310mm	5mm	12.5mm	16mm	37mm	Ø2mm
1121-2001WL	40-200mm/1.57-8"	A	±0.05mm	310mm	7mm	20mm	16mm	70mm	Ø3mm
1121-300AWL	30-300mm/1.18-12"	A	±0.07mm	410mm	5mm	15mm	16mm	50mm	Ø2mm
1121-3001AWL	50-300mm/1.97-12"	A	±0.07mm	410mm	8mm	25mm	16mm	77mm	Ø3mm
1121-500AWL	40-500mm/1.57-20"	A	±0.07mm	680mm	5mm	20mm	24mm	90mm	Ø3mm
1121-5001WL	60-500mm/2.36-20"	A	±0.08mm	680mm	10mm	30mm	24mm	120mm	Ø3mm
1121-5002WL	80-500mm/3.15-20"	A	±0.08mm	680mm	16mm	40mm	24mm	150mm	Ø3mm

No preset (need to add the width of the jaws on the reading)

Code	Range	Type	Accuracy	L	a	b	c	d	D
1121-150B	50-150mm/1.97-6"	B	±0.06mm	270mm	8mm	25mm	20mm	90mm	Ø3mm
1121-200B	60-200mm/2.36-8"	B	±0.06mm	320mm	10mm	30mm	20mm	100mm	Ø3mm
1121-300B	60-300mm/2.36-12"	B	±0.07mm	420mm	10mm	30mm	20mm	110mm	Ø3mm

DIGITAL INSIDE GROOVE CALIPERS

depth stop 6143
(optional)



- Measure groove diameter
- Resolution: 0.01mm/0.0005"
- Buttons type A: on/off, set, mm/inch, preset (+, -)
type B: on/off, zero, mm/inch
type C: on/off, zero, mm/inch, ABS/REL, hold
- Battery CR2032
- Made of stainless steel
- Optional accessory: depth stop
(code 6143, for calipers with c=16mm)

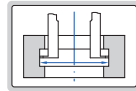
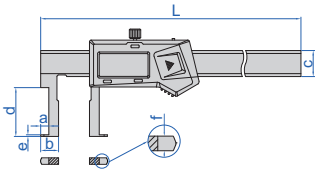

preset buttons



1120-150A
type A



1120-150B
type B



1120-150P
type C

Non waterproof, preset (no need to add the width of the jaws on the reading), with data interface

(mm)

Code	Range	Type	Accuracy	L	a	b	c	d	e	f	Data output cable (optional)
1120-150A	22-150mm/0.87-6"	A	±0.04mm	250	5	11	16	30	1	4	7315-25 (receiver is needed) page 5, 7214-25 page 11, 7302-21 page 20
1120-1501	35-150mm/1.38-6"	A	±0.06mm	250	6	17.5	16	60	1.5	4	
1120-200A	25-200mm/0.98-8"	A	±0.04mm	310	5	12.5	16	40	1	4	
1120-2001	40-200mm/1.57-8"	A	±0.06mm	310	7	20	16	70	2.5	4	
1120-300A	30-300mm/1.18-12"	A	±0.05mm	410	5	15	16	50	1.5	4	
1120-3001	50-300mm/1.97-12"	A	±0.07mm	410	8	25	16	80	2.5	4	7315-22 (receiver is needed) page 5, 7214-22 page 11, 7302-22 page 20
1120-500	40-500mm/1.57-20"	A	±0.07mm	680	5	20	24	90	2.2	5.5	
1120-5001	60-500mm/2.36-20"	A	±0.08mm	680	10	30	24	120	3.4	5.5	
1120-5002	80-500mm/3.15-20"	A	±0.08mm	680	16	40	24	150	5.2	5.5	

Non waterproof, preset (no need to add the width of the jaws on the reading),
built-in wireless (receiver code 7315-2/3/6/7/8/9 is needed)

Code	Range	Type	Accuracy	L	a	b	c	d	e	f
1120-150AWL	22-150mm/0.87-6"	A	±0.04mm	250mm	5mm	11mm	16mm	30mm	1mm	4mm
1120-1501WL	35-150mm/1.38-6"	A	±0.06mm	250mm	6mm	17.5mm	16mm	60mm	1.5mm	4mm
1120-200AWL	25-200mm/0.98-8"	A	±0.04mm	310mm	5mm	12.5mm	16mm	40mm	1mm	4mm
1120-2001WL	40-200mm/1.57-8"	A	±0.06mm	310mm	7mm	20mm	16mm	70mm	2.5mm	4mm
1120-300AWL	30-300mm/1.18-12"	A	±0.05mm	410mm	5mm	15mm	16mm	50mm	1.5mm	4mm
1120-3001WL	50-300mm/1.97-12"	A	±0.07mm	410mm	8mm	25mm	16mm	80mm	2.5mm	4mm
1120-500WL	40-500mm/1.57-20"	A	±0.07mm	680mm	5mm	20mm	24mm	90mm	2.2mm	5.5mm
1120-5001WL	60-500mm/2.36-20"	A	±0.08mm	680mm	10mm	30mm	24mm	120mm	3.4mm	5.5mm
1120-5002WL	80-500mm/3.15-20"	A	±0.08mm	680mm	16mm	40mm	24mm	150mm	5.2mm	5.5mm

Non waterproof, no preset (need to add the width of the jaws on the reading)

Code	Range	Type	Accuracy	L	a	b	c	d	e	f
1120-150B	50-150mm/1.97-6"	B	±0.06mm	270mm	8mm	25mm	20mm	90mm	3.4mm	4mm
1120-200B	60-200mm/2.36-8"	B	±0.06mm	320mm	10mm	30mm	20mm	100mm	3.4mm	4mm
1120-300B	60-300mm/2.36-12"	B	±0.07mm	420mm	10mm	30mm	20mm	110mm	3.4mm	4mm

IP67 dust/waterproof, no automatic power off, set zero after power on each time,
no preset (need to add the width of the jaws on the reading), without data interface

Code	Range	Type	Accuracy	L	a	b	c	d	e	f
1120-150P	22-150mm/0.87-6"	C	±0.04mm	250mm	5mm	11mm	16mm	30mm	1mm	4mm

INSIDE GROOVE VERNIER CALIPER

- Measure diameter of grooves inside bores
- Made of stainless steel
- Satin chrome plated reading surface



1262-150A

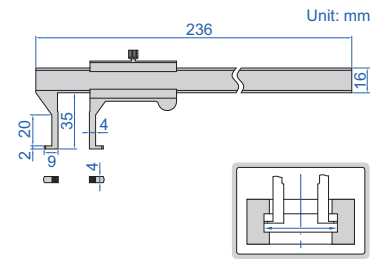

2

Code	Range	Graduation	Accuracy
1262-150A	18-150mm	0.02mm	±0.04mm

DIGITAL INSIDE GROOVE CALIPERS

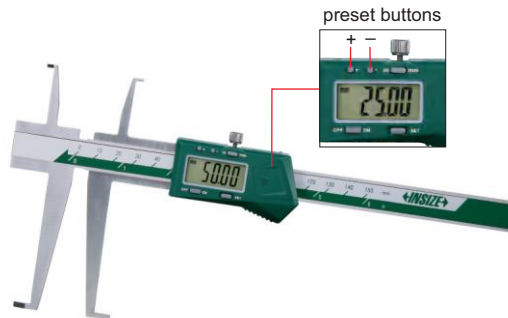

depth stop 6143 (optional)

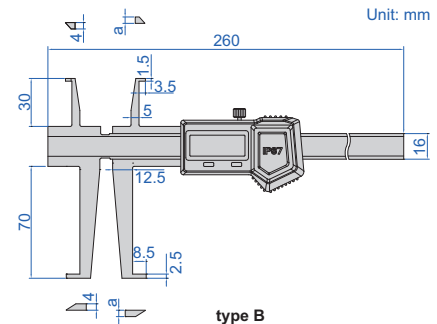
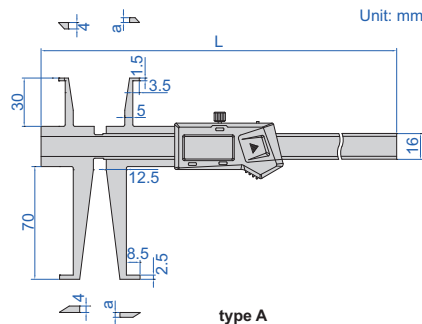

- Measure diameter of grooves inside bores
- Resolution: 0.01mm/0.0005"
- Buttons type A: on/off, set, mm/inch, preset (+, -)
type B: on/off, zero, mm/inch, ABS/REL, hold
- Battery CR2032
- Made of stainless steel
- Optional accessory: depth stop (code 6143)

sizes to be measured (use upper jaws)

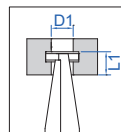

D1	L1
Ø9	<8
Ø10	<15
Ø11~200	<30

sizes to be measured (use lower jaws)

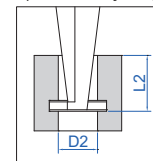

(mm)	
D2	L2
Ø17	<16
Ø18	<28
Ø19	<40
Ø20	<50
Ø21	<58
Ø22~200	<70

Non waterproof, with data interface

(optional data output cable: code 7315-25 receiver is needed page 5, 7214-25 page 11, 7302-21 page 20)

Code	Range of upper jaw	Range of lower jaw	Type	Accuracy	L	a
1176-150	9-150mm/0.35-6"	17-150mm/0.70-6"	A	±0.04mm	260mm	3mm
1176-200	9-200mm/0.35-8"	17-200mm/0.70-8"	A	±0.05mm	320mm	3.5mm

Non waterproof, built-in wireless (receiver code 7315-2/3/6/7/8/9 is needed)

Code	Range of upper jaw	Range of lower jaw	Type	Accuracy	L	a
1176-150WL	9-150mm/0.35-6"	17-150mm/0.70-6"	A	±0.04mm	260mm	3mm
1176-200WL	9-200mm/0.35-8"	17-200mm/0.70-8"	A	±0.05mm	320mm	3.5mm

IP67 dust/waterproof, without data interface, no automatic power off, set zero after power on each time

Code	Range of upper jaw	Range of lower jaw	Type	Accuracy	a
1176-150P	9-150mm/0.35-6"	17-150mm/0.70-6"	B	±0.04mm	4mm

INSIDE GROOVE CALIPERS

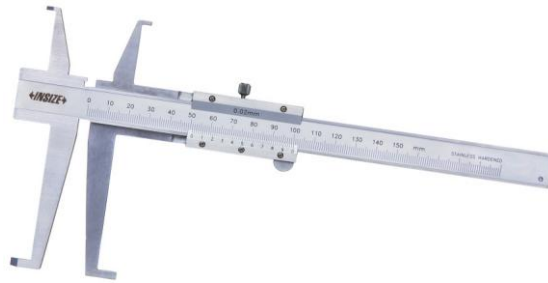

1199-150

depth stop 6143 (optional)



- Measure diameter of grooves inside bores
- Graduation: 0.02mm
- Made of stainless steel
- Optional accessory: depth stop (code 6143)

sizes to be measured (use upper jaws)

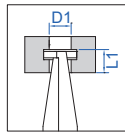

(mm)	
D1	L1
Ø9	<8
Ø10	<12
Ø11	<15
Ø12	<20
Ø13-300	<30

sizes to be measured (use lower jaws)

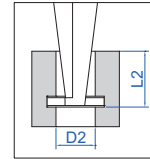

(mm)	
D2	L2
Ø18	<30
Ø19	<40
Ø20	<45
Ø21	<55
Ø22	<60
Ø23-300	<70

Code	Range of upper jaw	Range of lower jaw	Accuracy	L	a	b
1199-150	9-150mm	18-150mm	±0.04mm	248mm	1.6mm	2.5mm
1199-200	9-200mm	18-200mm	±0.05mm	298mm	1.8mm	2.8mm
1199-300	9-300mm	18-300mm	±0.06mm	398mm	2.0mm	3.0mm

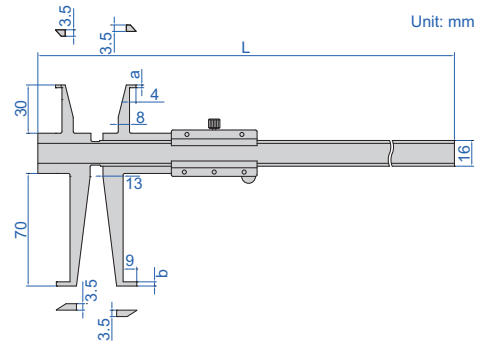

Unit: mm

INSIDE GROOVE DIAL CALIPERS

SHOCK PROOF

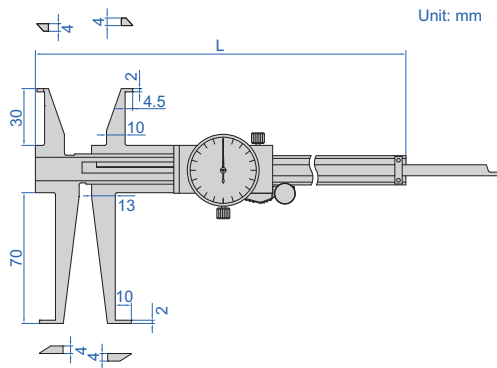

Unit: mm



1376-150

- Measure diameter of grooves inside bores
- Shockproof dial indicator
- Dial indicator graduation: 0.02mm
- Made of stainless steel
- Optional accessory: depth stop (code 6143)

sizes to be measured (use upper jaws)

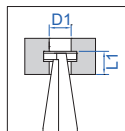

(mm)	
D1	L1
Ø11	<8
Ø12	<10
Ø13	<15
Ø14	<20
Ø15-300	<30

sizes to be measured (use lower jaws)

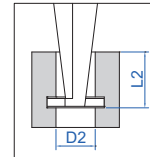

(mm)	
D2	L2
Ø18	<20
Ø19	<28
Ø20	<35
Ø21	<40
Ø22	<50
Ø23-300	<70

Code	Range of upper jaw	Range of lower jaw	Accuracy	L
1376-150	11-150mm	18-150mm	±0.03mm	240mm
1376-200	11-200mm	18-200mm	±0.03mm	290mm
1376-300	11-300mm	18-300mm	±0.04mm	390mm

DIGITAL INSIDE GROOVE CALIPERS

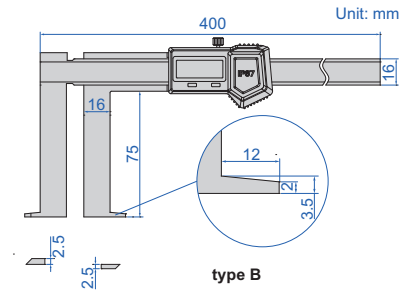
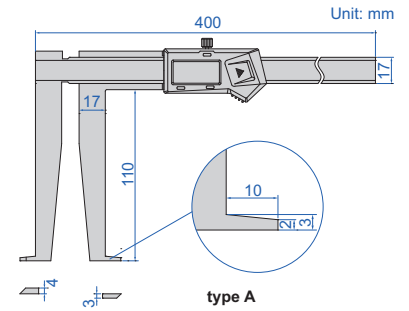
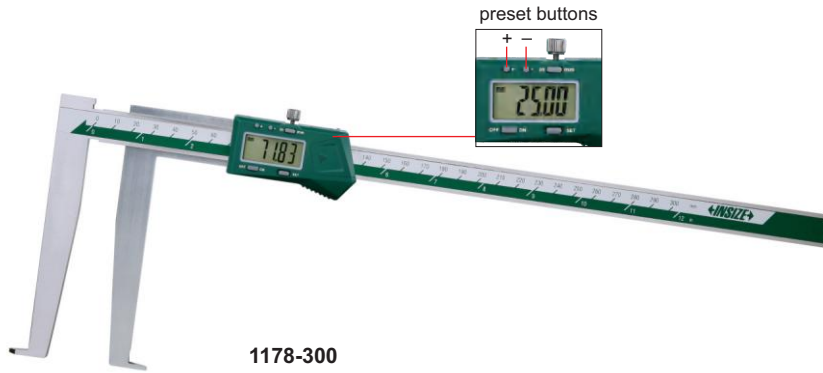

- Measure diameter of grooves inside bores
- Resolution: 0.01mm/0.0005"
- Buttons type A: on/off, set, mm/inch, preset (+, -)
type B: on/off, zero, mm/inch, ABS/REL, hold
- Battery CR2032
- Made of stainless steel
- Optional accessory: depth stop (code **6143**)

Non waterproof, with data interface (optional data output cable:
code 7315-25 receiver is needed page 5, 7214-25 page 11, 7302-21 page 20)

Code	Range	Type	Accuracy
1178-300	25-300mm/1.18-12"	A	±0.05mm

depth stop **6143**
(optional)



Non waterproof, built-in wireless
(receiver code 7315-2/3/6/7/8/9 is needed)

Code	Range	Type	Accuracy
1178-300WL	25-300mm/1.18-12"	A	±0.05mm

IP67 dust/waterproof, no automatic power off, set zero
after power on each time, without data interface

Code	Range	Type	Accuracy
1178-300P	33-300mm/1.30-12"	B	±0.05mm

DIGITAL DEEP HOLE INSIDE GROOVE CALIPERS

DATA OUTPUT

preset buttons



1129-300

- Non waterproof
- Measure diameter of grooves inside deep holes
- Resolution: 0.01mm/0.0005"
- Buttons: on/off, set, mm/inch, preset (+, -)
- Automatic power off, move the digital unit to turn on power
- Battery CR2032
- Made of stainless steel
- Optional accessory: depth stop (code 6143)

depth stop 6143 (optional)

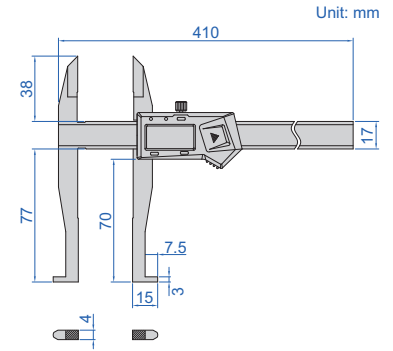

With data interface (optional data output cable: code 7315-25 receiver is needed page 5, 7214-25 page 11, 7302-21 page 20)

Code	Range of upper jaw	Range of lower jaw	Accuracy
1129-300	0-300mm/0-12"	30-300mm/1.2-12"	±0.06mm

Built-in wireless (receiver code 7315-2/3/6/7/8/9 is needed)

Code	Range of upper jaw	Range of lower jaw	Accuracy
1129-300WL	0-300mm/0-12"	30-300mm/1.2-12"	±0.06mm

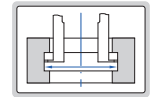

DIGITAL INSIDE GROOVE CALIPERS

DATA OUTPUT

- Non waterproof
- Measure diameter or distance of grooves
- Resolution: 0.01mm/0.0005"
- Buttons: on/off, set, mm/inch, preset (+, -)
- Automatic power off, move the digital unit to turn on power
- Battery CR2032
- Made of stainless steel



1128-200

preset buttons

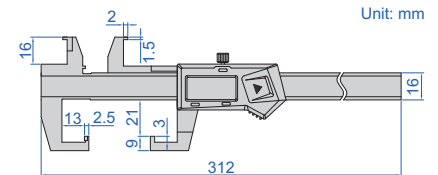

With data interface (optional data output cable: code 7315-25 receiver is needed page 5, 7214-25 page 11, 7302-21 page 20)

Code	Range of upper jaw	Range of lower jaw	Accuracy
1128-200	10-200mm/0.39-8"	3-200mm/0.12-8"	±0.03mm

Built-in wireless (receiver code 7315-2/3/6/7/8/9 is needed)

Code	Range of upper jaw	Range of lower jaw	Accuracy
1128-200WL	10-200mm/0.39-8"	3-200mm/0.12-8"	±0.03mm

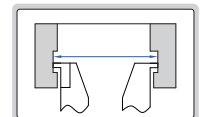
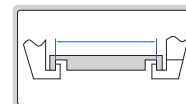

DATA
OUTPUT

DIGITAL INSIDE GROOVE CALIPERS



1191-150

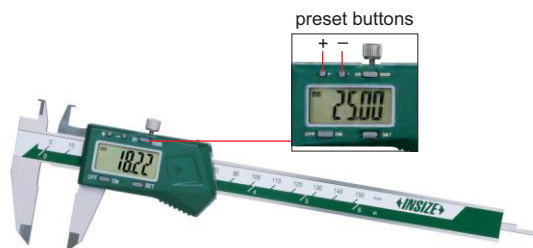

1191-150B

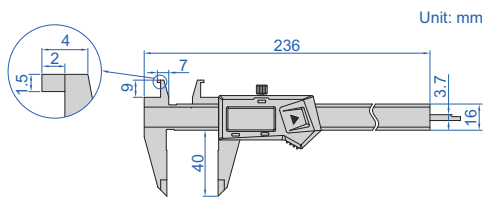

type A

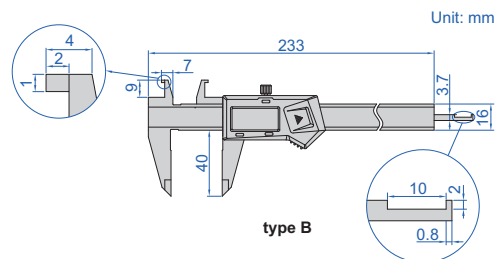

type B

- Non waterproof
- Upper jaws for measuring diameter of grooves
- Resolution: 0.01mm/0.0005"
- Buttons type A: on/off, zero, mm/inch
type B: on/off, set, mm/inch, preset (+, -)
- Automatic power off, move the digital unit to turn on power
- Battery CR2032
- Made of stainless steel

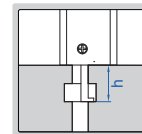
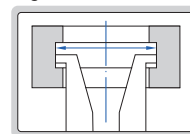
 measure depth of grooves
(h<10mm, only for type B)

 measure diameter of
grooves 8-150mm

With data interface

(optional data output cable: code 7315-25 receiver is needed page 5, 7214-25 page 11, 7302-21 page 20)

Code	Range of upper jaw	Range of lower jaw	Accuracy	Type
1191-150	8-150mm/0.3-6"	0-150mm/0-6"	±0.03mm	A
1191-150B	8-150mm/0.3-6"	0-150mm/0-6"	±0.03mm	B

Built-in wireless (receiver code 7315-2/3/6/7/8/9 is needed)

Code	Range of upper jaw	Range of lower jaw	Accuracy	Type
1191-150WL	8-150mm/0.3-6"	0-150mm/0-6"	±0.03mm	A
1191-150BWL	8-150mm/0.3-6"	0-150mm/0-6"	±0.03mm	B

INSIDE GROOVE VERNIER CALIPER

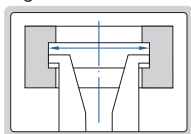
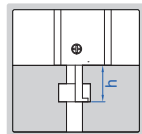
 measure diameter of
grooves 8-150mm

 measure depth of
grooves (h<10mm)

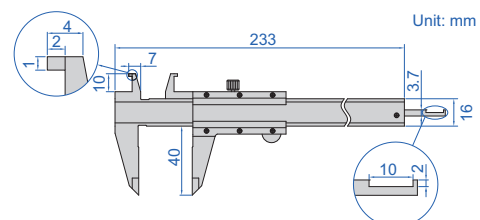
1291-150



- Graduation: 0.02mm
- Made of stainless steel
- Satin chrome plated reading surface

Code	Range of upper jaw	Range of lower jaw	Accuracy
1291-150	8-150mm	0-150mm	±0.03mm

DIGITAL OUTSIDE NECK CALIPERS

DATA OUTPUT

- Non waterproof
- Measure grooves and recesses
- Resolution: 0.01mm/0.0005"
- Buttons: on/off, zero, mm/inch
- Automatic power off, move the digital unit to turn on power
- Battery CR2032
- Made of stainless steel
- Optional accessory: depth stop (code **6143**, for calipers with e=16mm)



1187-150A

depth stop 6143 (optional)

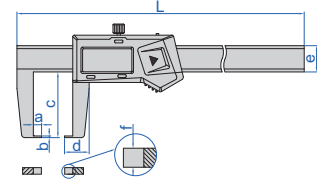
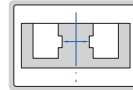

With data interface

Code	Range	Accuracy	L	a	b	c	d	e	f	Data output cable (optional)
1187-150A	0-150mm/0-6"	±0.04mm	250	5	1	40	15	16	4	7315-25 (receiver is needed) page 5, 7214-25 page 11, 7302-21 page 20
1187-200A	0-200mm/0-8"	±0.05mm	310	9	1.5	80	23	16	4	
1187-300A	0-300mm/0-12"	±0.06mm	490	12	2	150	36	24	4	7315-22 (receiver is needed) page 5, 7214-22 page 11, 7302-22 page 20
1187-500A	0-500mm/0-20"	±0.07mm	690	12	2	150	36	24	5.5	

Built-in wireless (receiver code 7315-2/3/6/7/8/9 is needed)

Code	Range	Accuracy	L	a	b	c	d	e	f
1187-150AWL	0-150mm/0-6"	±0.04mm	250mm	5mm	1mm	40mm	15mm	16mm	4mm
1187-200AWL	0-200mm/0-8"	±0.05mm	310mm	9mm	1.5mm	80mm	23mm	16mm	4mm
1187-300AWL	0-300mm/0-12"	±0.06mm	490mm	12mm	2mm	150mm	36mm	24mm	4mm
1187-500AWL	0-500mm/0-20"	±0.07mm	690mm	12mm	2mm	150mm	36mm	24mm	5.5mm

DIGITAL OUTSIDE POINT CALIPERS

DATA OUTPUT

- Non waterproof
- Measure wall thickness inside bores and recesses
- Resolution: 0.01mm/0.0005"
- Buttons: on/off, zero, mm/inch
- Automatic power off, move the digital unit to turn on power
- Battery CR2032
- Made of stainless steel
- Optional accessory: depth stop (code **6143**)



1185-150A

depth stop 6143 (optional)

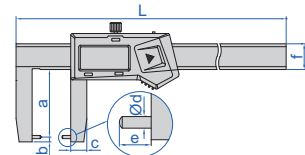
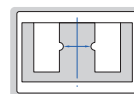

With data interface

Code	Range	Accuracy	L	a	b	c	Ød	e	f	Data output cable (optional)
1185-150A	0-150mm/0-6"	±0.04mm	250	40	3	10	2	5	16	7315-25 (receiver is needed) page 5, 7214-25 page 11, 7302-21 page 20
1185-200A	0-200mm/0-8"	±0.05mm	310	80	3	14	3	9	16	
1185-300A	0-300mm/0-12"	±0.06mm	490	150	3	20	3	12	24	7315-22 (receiver is needed) page 5, 7214-22 page 11, 7302-22 page 20

Built-in wireless (receiver code 7315-2/3/6/7/8/9 is needed)

Code	Range	Accuracy	L	a	b	c	Ød	e	f
1185-150AWL	0-150mm/0-6"	±0.04mm	250mm	40mm	3mm	10mm	2mm	5mm	16mm
1185-200AWL	0-200mm/0-8"	±0.05mm	310mm	80mm	3mm	14mm	3mm	9mm	16mm
1185-300AWL	0-300mm/0-12"	±0.06mm	490mm	150mm	3mm	20mm	3mm	12mm	24mm

DIGITAL OUTSIDE GROOVE CALIPERS

 DATA
OUTPUT

- Non waterproof
- Measure grooves and recesses in small spaces
- Resolution: 0.01mm/0.0005"
- Buttons: on/off, zero, mm/inch
- Automatic power off, move the digital unit to turn on power
- Battery CR2032
- Made of stainless steel



1535-100



With data interface (optional data output cable:
code 7315-25 receiver is needed page 5,
7214-25 page 11, 7302-21 page 20)

Code	Range	Accuracy
1535-100	0-100mm/0-4"	±0.03mm

Built-in wireless
(receiver code 7315-2/3/6/7/8/9 is needed)

Code	Range	Accuracy
1535-100WL	0-100mm/0-4"	±0.03mm

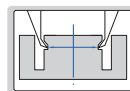
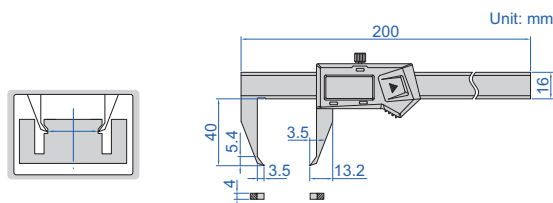

DEPTH STOP FOR CALIPERS

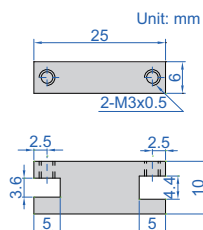

6143

 Code
6143

- Supplied in pair
- Made of stainless steel
- Suitable for caliper series 1124, 1526, 1530, 1199, 1520, 1176, 1178, 1120, 1121, 1187, 1129, 1185 and 1376

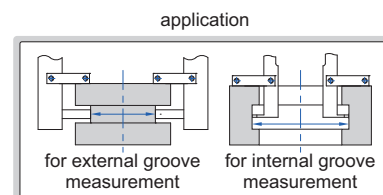

DIGITAL SMALL POINT CALIPERS

 DATA
OUTPUT

- Non waterproof
- Small pointed jaws fit into small grooves and recesses
- Resolution: 0.01mm/0.0005"
- Buttons: on/off, zero, mm/inch
- Automatic power off, move the digital unit to turn on power
- Battery CR2032
- Made of stainless steel



1169-150

With data interface (optional data output cable:
code 7315-25 receiver is needed page 5,
7214-25 page 11, 7302-21 page 20)

Code	Range	Accuracy
1169-150	0-150mm/0-6"	±0.03mm

Built-in wireless
(receiver code 7315-2/3/6/7/8/9 is needed)

Code	Range	Accuracy
1169-150WL	0-150mm/0-6"	±0.03mm

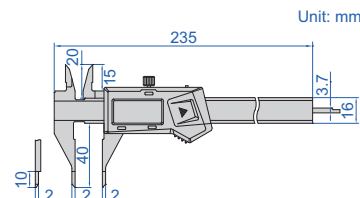
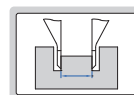

DIGITAL POINT CALIPERS

DATA
OUTPUT

2

- Non waterproof
- Pointed jaws fit into small grooves and recesses
- Resolution: 0.01mm/0.0005"
- Buttons: on/off, zero, mm/inch
- Automatic power off, move the digital unit to turn on power
- Battery CR2032
- Made of stainless steel



1183-150A

With data interface (optional data output cable:
code 7315-25 receiver is needed page 5, 7214-25 page 11, 7302-21 page 20)

Code	Range	Accuracy	L	a	b	c
1183-150A	0-150mm/0-6"	±0.03mm	236mm	40mm	21mm	16.5mm
1183-200A	0-200mm/0-8"	±0.03mm	286mm	50mm	24mm	19.5mm
1183-300A	0-300mm/0-12"	±0.03mm	400mm	60mm	25mm	21.5mm

Built-in wireless (receiver code 7315-2/3/6/7/8/9 is needed)

Code	Range	Accuracy	L	a	b	c
1183-150AWL	0-150mm/0-6"	±0.03mm	236mm	40mm	21mm	16.5mm
1183-200AWL	0-200mm/0-8"	±0.03mm	286mm	50mm	24mm	19.5mm
1183-300AWL	0-300mm/0-12"	±0.03mm	400mm	60mm	25mm	21.5mm

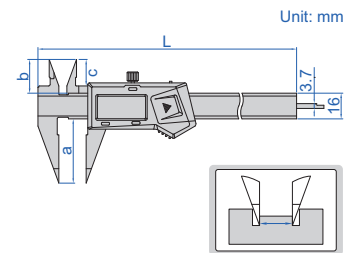

DIGITAL CALIPERS WITH POSITIONING SURFACES

DATA
OUTPUT

- Non waterproof
- Lower jaws with positioning surfaces, for measuring inside diameters quickly
- Resolution: 0.01mm/0.0005"
- Buttons: on/off, set, mm/inch, preset (+, -)
- Automatic power off, move the digital unit to turn on power
- Battery CR2032
- Made of stainless steel



1534-200

With data interface (optional data output cable:
code 7315-25 receiver is needed page 5,
7214-25 page 11, 7302-21 page 20)

Code	Range	Accuracy
1534-200	0-200mm/0-8"	±0.03mm

Built-in wireless
(receiver code 7315-2/3/6/7/8/9 is needed)

Code	Range	Accuracy
1534-200WL	0-200mm/0-8"	±0.03mm

preset buttons

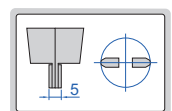
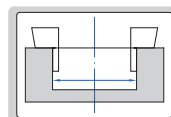
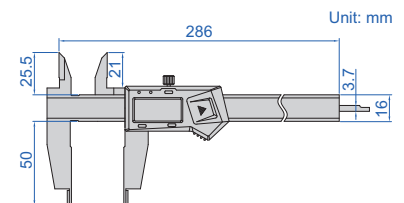
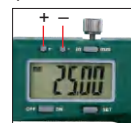

DATA
OUTPUT

DIGITAL INSIDE KNIFE-EDGE CALIPERS

2



1123-150A

- Non waterproof
- Measure diameter of deep step holes
- Resolution: 0.01mm/0.0005"
- Buttons: on/off, zero, mm/inch
- Automatic power off, move the digital unit to turn on power
- Battery CR2032
- Made of stainless steel

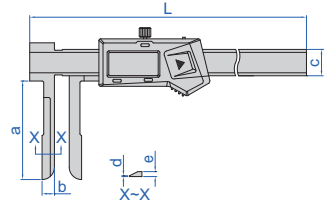
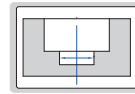

With data interface

(mm)

Code	Range	Accuracy	L	a	b	c	d	e	Data output cable (optional)
1123-150A	15-150mm/0.6-6"	±0.05mm	250	60	12	16	0.3	3.5	7315-25 (receiver is needed) page 5, 7214-25 page 11, 7302-21 page 20
1123-200A	20-200mm/0.8-8"	±0.06mm	305	100	17	16	0.3	3.5	
1123-300A	24-300mm/0.9-12"	±0.06mm	500	150	22	24	0.5	3.5	7315-22 (receiver is needed) page 5, 7214-22 page 11, 7302-22 page 20

Built-in wireless (receiver code 7315-2/3/6/7/8/9 is needed)

Code	Range	Accuracy	L	a	b	c	d	e
1123-150AWL	15-150mm/0.6-6"	±0.05mm	250mm	60mm	12mm	16mm	0.3mm	3.5mm
1123-200AWL	20-200mm/0.8-8"	±0.06mm	305mm	100mm	17mm	16mm	0.3mm	3.5mm

DATA
OUTPUT

DIGITAL CALIPERS WITH KNIFE-EDGE LOWER JAWS

- Non waterproof
- Measure diameter of narrow grooves
- Resolution: 0.01mm/0.0005"
- Buttons: on/off, zero, mm/inch
- Automatic power off, move the digital unit to turn on power
- Battery CR2032
- Made of stainless steel



1532-200

With data interface (optional data output cable:
code 7315-25 receiver is needed page 5,
7214-25 page 11, 7302-21 page 20)

Code	Range	Accuracy
1532-200	0-200mm/0-8"	±0.03mm

Built-in wireless
(receiver code 7315-2/3/6/7/8/9 is needed)

Code	Range	Accuracy
1532-200WL	0-200mm/0-8"	±0.03mm

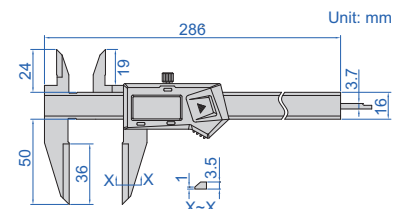
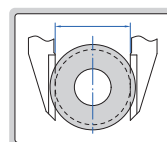

DIGITAL CALIPERS WITH LONG UPPER JAWS

DATA OUTPUT

2

- Non waterproof
- Long upper jaws for measuring diameter of deep holes
- Resolution: 0.01mm/0.0005"
- Buttons: on/off, zero, mm/inch
- Automatic power off, move the digital unit to turn on power
- Battery CR2032
- Made of stainless steel



1138-200

With data interface (optional data output cable: code 7315-25 receiver is needed page 5, 7214-25 page 11, 7302-21 page 20)

Code	Range	Accuracy
1138-200	0-200mm/0-8"	±0.04mm

Built-in wireless (receiver code 7315-2/3/6/7/8/9 is needed)

Code	Range	Accuracy
1138-200WL	0-200mm/0-8"	±0.04mm

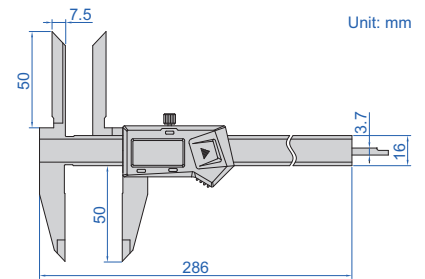
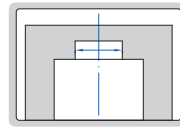

DIAL CALIPERS WITH LONG UPPER JAWS

SHOCK PROOF



1338-300

- Long upper jaws for measuring diameter of deep holes
- Shockproof dial indicator
- Dial indicator graduation: 0.02mm
- Made of stainless steel

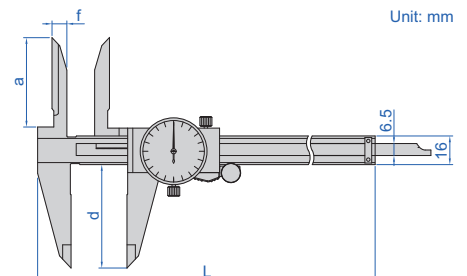
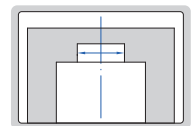

Code	Range	Accuracy	L	a	d	f
1338-150	0-150mm	±0.03mm	236	40	40	6.5
1338-200	0-200mm	±0.03mm	288	45	50	7.5
1338-300	0-300mm	±0.04mm	400	50	60	8

DIGITAL CENTERLINE AND EDGE TO CENTER CALIPERS



1521-2002

- Non waterproof
- Measure hole center distance in the same or offset planes and edge to hole center distance
- Resolution: 0.01mm/0.0005"
- Buttons: on/off, set, mm/inch, preset (+, -)
- Automatic power off, move the digital unit to turn on power
- Battery CR2032
- Made of stainless steel

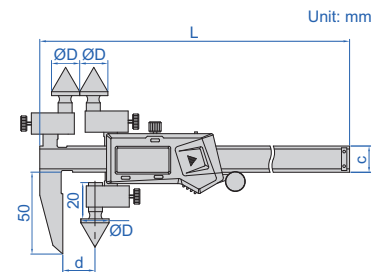

With data interface (optional data output cable:

code 7315-25 receiver is needed page 5, 7214-25 page 11, 7302-21 page 20)

(mm)

Code	Range	Accuracy	ØD	d	L	c
1521-150	5-140mm/0.2-5.5"	±0.05mm	5	5	236	16
1521-1501	10-140mm/0.4-5.5"	±0.05mm	10	10	236	16
1521-1502	20-140mm/0.8-5.5"	±0.05mm	20	20	236	16
1521-200	5-190mm/0.2-7.5"	±0.05mm	5	5	285	16
1521-2001	10-190mm/0.4-7.5"	±0.05mm	10	10	285	16
1521-2002	20-190mm/0.8-7.5"	±0.05mm	20	20	285	16
1521-300	5-290mm/0.2-11.5"	±0.07mm	5	5	385	17
1521-3001	10-290mm/0.4-11.5"	±0.07mm	10	10	385	17
1521-3002	20-290mm/0.8-11.5"	±0.07mm	20	20	385	17

measure hole center distance

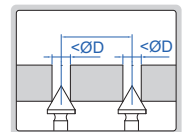

Built-in wireless (receiver code 7315-2/3/6/7/8/9 is needed)

(mm)

Code	Range	Accuracy	ØD	d	L	c
1521-150WL	5-140mm/0.2-5.5"	±0.05mm	5	5	236	16
1521-1501WL	10-140mm/0.4-5.5"	±0.05mm	10	10	236	16
1521-1502WL	20-140mm/0.8-5.5"	±0.05mm	20	20	236	16
1521-200WL	5-190mm/0.2-7.5"	±0.05mm	5	5	285	16
1521-2001WL	10-190mm/0.4-7.5"	±0.05mm	10	10	285	16
1521-2002WL	20-190mm/0.8-7.5"	±0.05mm	20	20	285	16
1521-300WL	5-290mm/0.2-11.5"	±0.07mm	5	5	385	17
1521-3001WL	10-290mm/0.4-11.5"	±0.07mm	10	10	385	17
1521-3002WL	20-290mm/0.8-11.5"	±0.07mm	20	20	385	17

measure edge to hole center distance

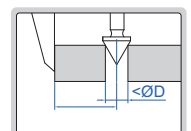

DIGITAL CENTERLINE AND EDGE TO CENTER CALIPERS

DATA
OUTPUT

2



1525-300

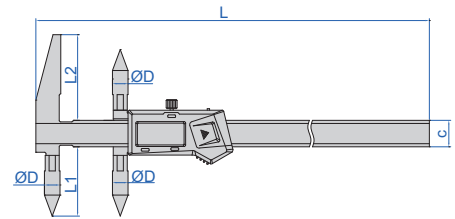

- Non waterproof
- Measure hole center distance or edge to hole center distance
- Resolution: 0.01mm/0.0005"
- Buttons: on/off, set, mm/inch, preset (+, -)
- Automatic power off, move the digital unit to turn on power
- Battery CR2032
- Made of stainless steel

measure edge to hole center distance

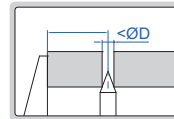

measure hole center distance

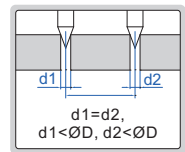

With data interface

(mm)

Code	Range of upper jaw (edge to center)	Range of lower jaw (center to center)	Accuracy	ØD	L1	L2	c	L	Data output cable (optional)
1525-300	5-300mm/0.2-12"	10-300mm/0.4-12"	±0.08mm	10	44.5	55	17	410	7315-25 (receiver is needed) page 5, 7214-25 page 11, 7302-21 page 20
1525-3001	10-300mm/0.4-12"	20-300mm/0.8-12"	±0.08mm	20	48	60	17	410	
1525-500	10-500mm/0.4-20"	20-500mm/0.8-20"	±0.09mm	20	50	60	24	690	7315-22 (receiver is needed) page 5, 7214-22 page 11, 7302-22 page 20
1525-1000	15-1000mm/0.6-40"	30-1000mm/1.2-40"	±0.12mm	30	70	81	31	1255	
1525-1500	15-1500mm/0.6-60"	30-1500mm/1.2-60"	±0.15mm	30	70	81	31	1760	

Built-in wireless (receiver code 7315-2/3/6/7/8/9 is needed)

(mm)

Code	Range of upper jaw (edge to center)	Range of lower jaw (center to center)	Accuracy	ØD	L1	L2	c	L
1525-300WL	5-300mm/0.2-12"	10-300mm/0.4-12"	±0.08mm	10	44.5	55	17	410
1525-3001WL	10-300mm/0.4-12"	20-300mm/0.8-12"	±0.08mm	20	48	60	17	410
1525-500WL	10-500mm/0.4-20"	20-500mm/0.8-20"	±0.09mm	20	50	60	24	690

DATA
OUTPUT

DIGITAL OFFSET CENTERLINE CALIPERS

1192-150A

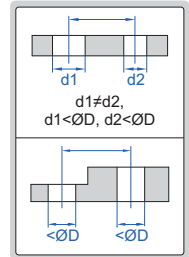
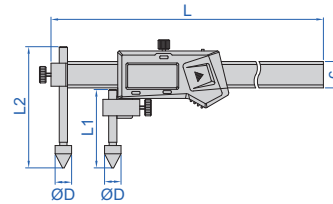

- Non waterproof
- Measure hole center distance in the same or offset planes
- Resolution: 0.01mm/0.0005"
- Buttons: on/off, set, mm/inch, preset (+, -)
- Automatic power off, move the digital unit to turn on power
- Battery CR2032
- Made of stainless steel

With data interface

Code	Range	Accuracy	c	ØD	L1	L2	L	Data output cable (optional)
1192-150A	10-150mm/0.4-6"	±0.05mm	16mm	10mm	46mm	79mm	236mm	7315-25 (receiver is needed) page 5, 7214-25 page 11, 7302-21 page 20
1192-200A	10-200mm/0.4-8"	±0.07mm	16mm	10mm	46mm	79mm	286mm	
1192-300A	10-300mm/0.4-12"	±0.09mm	16mm	10mm	46mm	79mm	396mm	
1192-500A	20-500mm/0.8-20"	±0.09mm	24mm	20mm	70mm	110mm	683mm	
1192-1000A	30-1000mm/1.2-40"	±0.12mm	31mm	30mm	75mm	120mm	1255mm	7315-22 (receiver is needed) page 5, 7214-22 page 11, 7302-22 page 20
1192-1500A	30-1500mm/1.2-60"	±0.15mm	31mm	30mm	75mm	120mm	1760mm	

Built-in wireless (receiver code 7315-2/3/6/7/8/9 is needed)

Code	Range	Accuracy	c	ØD	L1	L2	L
1192-150AWL	10-150mm/0.4-6"	±0.05mm	16mm	10mm	46mm	79mm	236mm
1192-200AWL	10-200mm/0.4-8"	±0.07mm	16mm	10mm	46mm	79mm	286mm
1192-300AWL	10-300mm/0.4-12"	±0.09mm	16mm	10mm	46mm	79mm	396mm
1192-500AWL	20-500mm/0.8-20"	±0.09mm	24mm	20mm	52mm	112mm	725mm

 DATA
OUTPUT

DIGITAL BACK-JAW CENTERLINE CALIPERS

1177-200

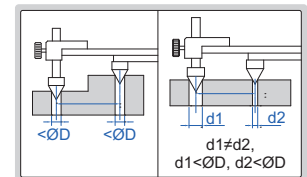
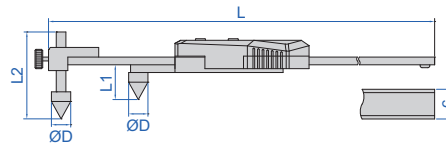

- Non waterproof
- Measure hole center distance in the same or offset planes
- Resolution: 0.01mm/0.0005"
- Buttons: on/off, set, mm/inch, preset (+, -)
- Automatic power off, move the digital unit to turn on power
- Battery CR2032
- Made of stainless steel

With data interface

Code	Range	Accuracy	ØD	c	L1	L2	L	Data output cable (optional)
1177-200	10-200mm/0.4-8"	±0.10mm	10mm	16mm	18mm	45mm	310mm	7315-25 (receiver is needed) page 5, 7214-25 page 11, 7302-21 page 20
1177-300	10-300mm/0.4-12"	±0.10mm	10mm	16mm	18mm	45mm	410mm	
1177-500	20-500mm/0.8-20"	±0.10mm	20mm	24mm	26mm	70mm	692mm	7315-22 (receiver is needed) page 5, 7214-22 page 11, 7302-22 page 20
1177-1000	30-1000mm/1.2-40"	±0.12mm	30mm	31mm	39mm	70mm	1242mm	
1177-1500	30-1500mm/1.2-60"	±0.15mm	30mm	31mm	39mm	70mm	1745mm	

Built-in wireless (receiver code 7315-2/3/6/7/8/9 is needed)

Code	Range	Accuracy	ØD	c	L1	L2	L
1177-200WL	10-200mm/0.4-8"	±0.10mm	10mm	16mm	18mm	45mm	310mm
1177-300WL	10-300mm/0.4-12"	±0.10mm	10mm	16mm	18mm	45mm	410mm
1177-500WL	20-500mm/0.8-20"	±0.10mm	20mm	24mm	26mm	70mm	692mm

back-jaw



DIGITAL BACK-JAW EDGE TO CENTER CALIPERS

DATA
OUTPUT

2

- Non waterproof
- Measure edge to hole center distance
- Resolution: 0.01mm/0.0005"
- Buttons: on/off, set, mm/inch, preset (+, -)
- Automatic power off, move the digital unit to turn on power
- Battery CR2032
- Made of stainless steel

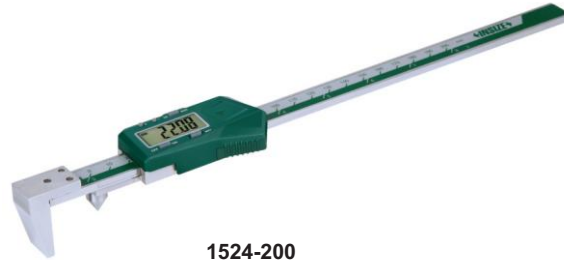

1524-200

back-jaw



With data interface (optional data output cable:
code 7315-25 receiver is needed page 5,
7214-25 page 11, 7302-21 page 20)

Code	Range	Accuracy	L
1524-200	5-200mm/0.2-8"	±0.1mm	310mm
1524-300	5-300mm/0.2-12"	±0.1mm	410mm

Built-in wireless
(receiver code 7315-2/3/6/7/8/9 is needed)

Code	Range	Accuracy	L
1524-200WL	5-200mm/0.2-8"	±0.1mm	310mm
1524-300WL	5-300mm/0.2-12"	±0.1mm	410mm

preset buttons

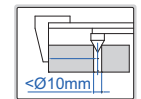
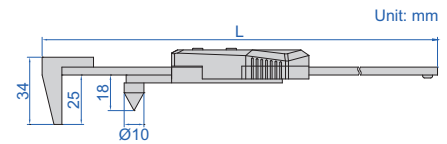
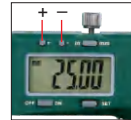

DIGITAL BLADE CALIPERS

DATA
OUTPUT



1188-150A

- Non waterproof
- The blade jaws fit into small grooves
- Resolution: 0.01mm/0.0005"
- Buttons: on/off, zero, mm/inch
- Automatic power off, move the digital unit to turn on power
- Battery CR2032
- Made of stainless steel

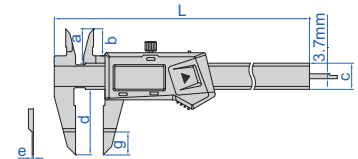
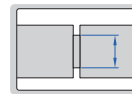

With data interface (optional data output cable: code 7315-25 receiver is needed page 5, 7214-25 page 11, 7302-21 page 20)

Code	Range	Accuracy	L	a	b	c	d	e	g
1188-150A	0-150mm/0-6"	±0.03mm	235mm	21mm	16.5mm	16mm	40mm	0.85mm	17mm
1188-200A	0-200mm/0-8"	±0.03mm	297mm	24mm	20mm	16mm	50mm	0.85mm	17mm
1188-300A	0-300mm/0-12"	±0.04mm	390mm	26mm	21.5mm	16mm	60mm	1.00mm	17mm

Built-in wireless (receiver code 7315-2/3/6/7/8/9 is needed)

Code	Range	Accuracy	L	a	b	c	d	e	g
1188-150AWL	0-150mm/0-6"	±0.03mm	235mm	21mm	16.5mm	16mm	40mm	0.85mm	17mm
1188-200AWL	0-200mm/0-8"	±0.03mm	297mm	24mm	20mm	16mm	50mm	0.85mm	17mm
1188-300AWL	0-300mm/0-12"	±0.04mm	390mm	26mm	21.5mm	16mm	60mm	1.00mm	17mm

DATA
OUTPUT

DIGITAL HOOK CALIPERS

2



1122-300

- Non waterproof
- Measure width and distance of grooves inside bores
- Resolution: 0.01mm/0.0005"
- Buttons: on/off, zero, mm/inch
- Automatic power off, move the digital unit to turn on power
- Battery CR2032
- Made of stainless steel

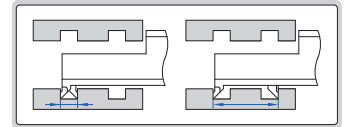
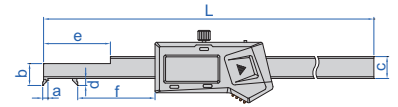

With data interface (optional data output cable: code 7315-25 receiver is needed page 5, 7214-25 page 11, 7302-21 page 20)

Code	Range	Accuracy	L	a	b	c	d	e	f
1122-150	3-150mm/0.12-6"	±0.03mm	260mm	3mm	12mm	12.5mm	4mm	24mm	27mm
1122-200	3-200mm/0.12-8"	±0.03mm	310mm	3mm	12mm	12.5mm	4mm	24mm	27mm
1122-300	4-300mm/0.16-12"	±0.04mm	466mm	4mm	14mm	15mm	5mm	86mm	89mm

Built-in wireless (receiver code 7315-2/3/6/7/8/9 is needed)

Code	Range	Accuracy	L	a	b	c	d	e	f
1122-150WL	3-150mm/0.12-6"	±0.03mm	260mm	3mm	12mm	12.5mm	4mm	24mm	27mm
1122-200WL	3-200mm/0.12-8"	±0.03mm	310mm	3mm	12mm	12.5mm	4mm	24mm	27mm
1122-300WL	4-300mm/0.16-12"	±0.04mm	466mm	4mm	14mm	15mm	5mm	86mm	89mm

DATA
OUTPUT

DIGITAL EXTERNAL HOOK CALIPERS



1164-200

- Non waterproof
- Measure width and distance of grooves inside bores
- Resolution: 0.01mm/0.0005"
- Buttons: on/off, zero, mm/inch
- Automatic power off, move the digital unit to turn on power
- Battery CR2032
- Made of stainless steel

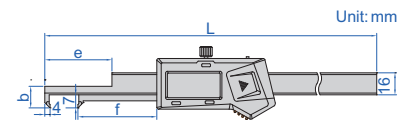

With data interface (optional data output cable: code 7315-25 receiver is needed page 5, 7214-25 page 11, 7302-21 page 20)

Code	Range	Accuracy	L	b	e	f
1164-150	0-150mm/0-6"	±0.03mm	275mm	14mm	52mm	50mm
1164-200	0-200mm/0-8"	±0.03mm	325mm	14mm	52mm	50mm
1164-300	0-300mm/0-12"	±0.04mm	460mm	15mm	82mm	80mm

Built-in wireless (receiver code 7315-2/3/6/7/8/9 is needed)

Code	Range	Accuracy	L	b	e	f
1164-150WL	0-150mm/0-6"	±0.03mm	275mm	14mm	52mm	50mm
1164-200WL	0-200mm/0-8"	±0.03mm	325mm	14mm	52mm	50mm
1164-300WL	0-300mm/0-12"	±0.04mm	460mm	15mm	82mm	80mm

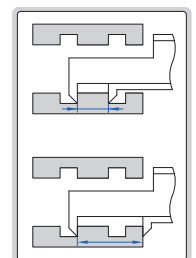

DIGITAL V SHAPE CALIPER

DIRECT READING,
CALCULATION IS NOT REQUIRED

DATA
OUTPUT

2



1539-3

- Non waterproof
- Measure outside diameter of three number of flutes (such as taps, reamers, end mills and gears)
- Resolution: 0.01mm/0.0005"
- Buttons: on/off, zero, mm/inch
- Battery CR2032
- Automatic power off, move the digital unit to turn on power
- Data output
- Made of stainless steel
- Optional accessory:
wireless transmitter code **7315-25** (receiver is needed) page 5,
bluetooth transmitter code **7214-25** page 11,
data output cable code **7302-21** page 20

Code	Range	Accuracy
1539-3	Ø4-Ø40mm/0.16"-1.58" DIA	±0.03mm

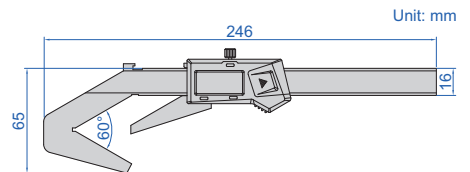

V SHAPE VERNIER CALIPER



1273-403

- Measure outside diameter of three number of flutes (such as taps, reamers, end mills and gears)
- Made of stainless steel
- Satin chrome plated reading surface

Code	Range	Graduation	Accuracy
1273-403	Ø4-40mm	0.05mm	±0.05mm

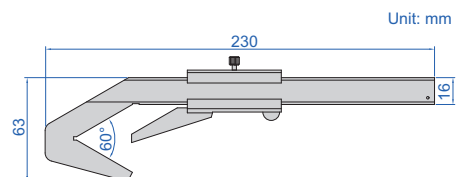

DIRECT READING,
CALCULATION IS NOT REQUIRED

DATA
OUTPUT

DIGITAL V TYPE CALIPERS

2

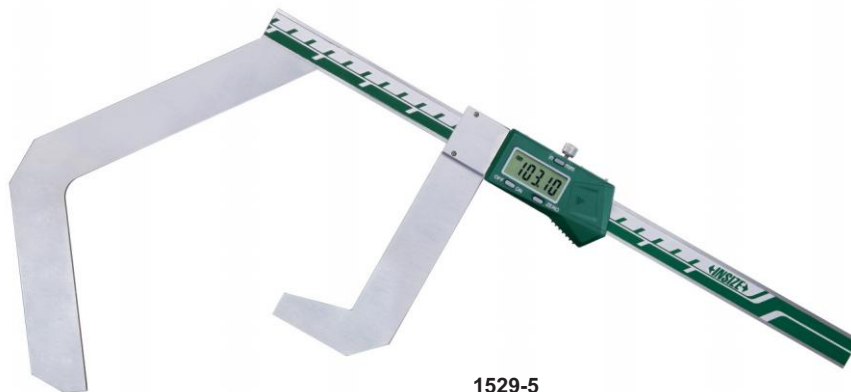

1529-5

- Non waterproof
- Measure the outside diameter of odd number of flutes (such as taps, reamers, end mills and gears)
- Resolution: 0.01mm/0.0005"
- Buttons: on/off, zero, mm/inch
- Battery CR2032
- Automatic power off, move the digital unit to turn on power
- Data output
- Made of stainless steel
- Optional accessory: Ø50mm calibration cylinder (code **6316-50**), wireless transmitter code **7315-25** (receiver is needed) page 5, bluetooth transmitter code **7214-25** page 11, data output cable code **7302-21** page 20

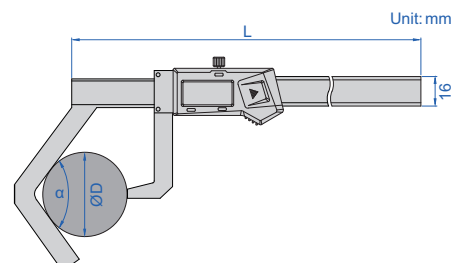

Ø50mm calibration cylinder
(code **6316-50**, optional)



Code	Range (ØD)	Flutes	Accuracy	Angle α	L
1529-3	Ø50-Ø200mm/2-8" DIA	3	±0.06mm	60°	390mm
1529-5	Ø50-Ø200mm/2-8" DIA	5	±0.06mm	108°	318mm
1529-19	Ø50-Ø200mm/2-8" DIA	19	±0.06mm	85°15'47"	336mm
1529-23	Ø50-Ø200mm/2-8" DIA	23	±0.06mm	70°26'5"	362mm
1529-31	Ø50-Ø200mm/2-8" DIA	31	±0.06mm	75°29'2"	355mm

V SHAPE VERNIER CALIPERS

- Measure outside diameter of odd number of flutes (such as taps, reamers, end mills and gears)
- Made of stainless steel
- Satin chrome plated reading surface
- Optional accessory: 4mm pin gauge (code **4110-4D00**), Ø50mm calibration cylinder (code **6316-50**)



1229-3

Code	Range (ØD)	Graduation	Accuracy	Flutes	Angle α	L	c
1229-3	Ø4-60mm	0.02mm	±0.04mm	3	60°	260mm	16mm
1229-35	Ø50-200mm	0.02mm	±0.06mm	3	60°	516mm	20mm
1229-5	Ø4-60mm	0.02mm	±0.04mm	5	108°	210mm	16mm
1229-55	Ø50-200mm	0.02mm	±0.06mm	5	108°	360mm	20mm

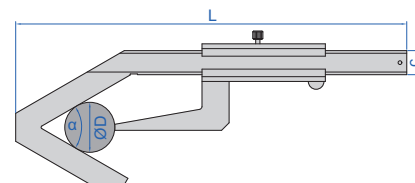

DIGITAL CALIPERS WITH ONE DIRECTION UPPER JAWS

DATA OUTPUT

2



1184-200



1184-150A

- Non waterproof
- Resolution: 0.01mm/0.0005"
- Buttons: zero, power on/off, inch/mm
- Automatic power off, move the digital unit to turn on power
- Battery CR2032
- Data output
- Made of stainless steel
- Optional accessory: wireless transmitter code **7315-25** (receiver is needed) page 5, bluetooth transmitter code **7214-25** page 11, data output cable code **7302-21** page 20

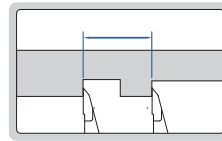
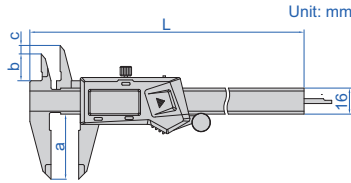

jaws with same height used for measuring the distance in same level

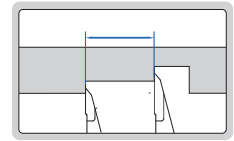

jaws with different height used for measuring the distance in different level

Jaws with same height (mm)

Code	Range	Accuracy	L	a	b	c
1184-150	0-150mm/0-6"	±0.03mm	236	40	17	0
1184-200	0-200mm/0-8"	±0.03mm	286	50	20	0
1184-300	0-300mm/0-12"	±0.03mm	400	60	22	0

Jaws with different height (mm)

Code	Range	Accuracy	L	a	b	c
1184-150A	0-150mm/0-6"	±0.03mm	236	40	17	5
1184-200A	0-200mm/0-8"	±0.03mm	286	50	20	8
1184-300A	0-300mm/0-12"	±0.03mm	400	60	22	10

DIGITAL OFFSET CALIPERS

DATA OUTPUT



1186-150A

- Non waterproof
- The left jaw can slide up and down to facilitate measurement of stepped sections
- Resolution: 0.01mm/0.0005"
- Buttons: on/off, zero, mm/inch
- Automatic power off, move the digital unit to turn on power
- Battery CR2032
- Made of stainless steel

With data interface (optional data output cable: code **7315-25** receiver is needed page 5, **7214-25** page 11, **7302-21** page 20) (mm)

Code	Range	Accuracy	L	a	b	c	d	e	f
1186-150A	0-150mm/0-6"	±0.04mm	249	40	16.5	10	110	17	7
1186-200A	0-200mm/0-8"	±0.04mm	299	50	19.5	10	120	17	7
1186-300A	0-300mm/0-12"	±0.05mm	399	60	20.5	10	130	17	7

Built-in wireless (receiver code **7315-2/3/6/7/8/9** is needed) (mm)

Code	Range	Accuracy	L	a	b	c	d	e	f
1186-150AWL	0-150mm/0-6"	±0.04mm	249	40	16.5	10	110	17	7
1186-200AWL	0-200mm/0-8"	±0.04mm	299	50	19.5	10	120	17	7
1186-300AWL	0-300mm/0-12"	±0.05mm	399	60	20.5	10	130	17	7

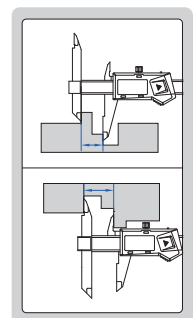
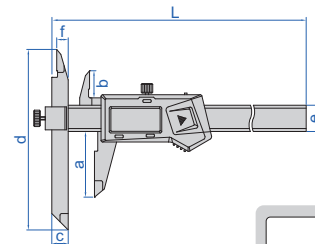

DATA OUTPUT

DIGITAL TUBE THICKNESS CALIPERS

- Non waterproof
- Measure wall thickness of tubes
- Resolution: 0.01mm/0.0005"
- Buttons: on/off, zero, mm/inch
- Automatic power off, move the digital unit to turn on power
- Battery CR2032
- Made of stainless steel



1161-150A

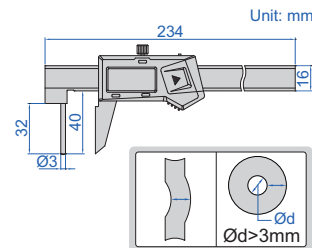

With data interface (optional data output cable: code 7315-25 receiver is needed page 5, 7214-25 page 11, 7302-21 page 20)

Code	Range	Accuracy
1161-150A	0-150mm/0-6"	±0.05mm

Built-in wireless (receiver code 7315-2/3/6/7/8/9 is needed)

Code	Range	Accuracy
1161-150AWL	0-150mm/0-6"	±0.05mm

DATA OUTPUT

DIGITAL RTJ RING GROOVE CALIPERS

- Non waterproof
- Angle of RTJ ring groove: 23°
- Measure ring grooves of flange
- Resolution: 0.01mm/0.0005"
- Button function: on/off, set, zero, mm/inch, data preset
- Battery CR2032
- Made of stainless steel

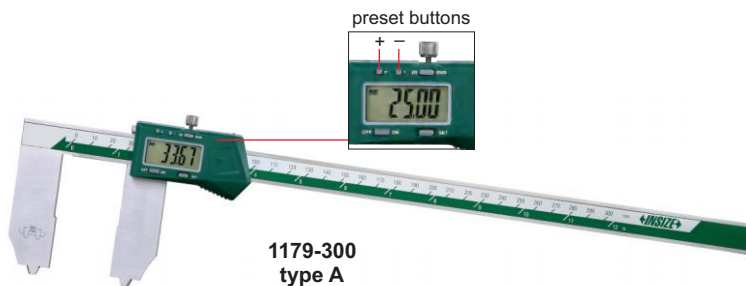

1179-300 type A

applicable for RTJ ring grooves with angle 23°

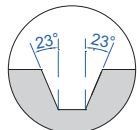

d and e need to be added on the reading

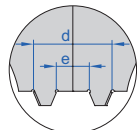

1179-600 type B

measure outside diameter of RTJ ring groove

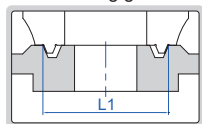

measure inside diameter of RTJ ring groove

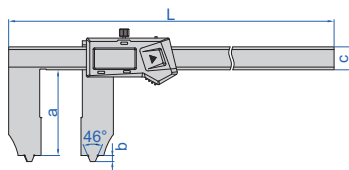
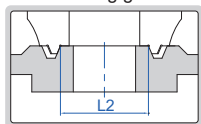

type A

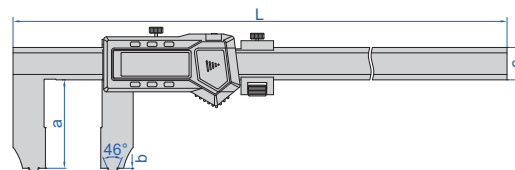

type B

With data interface

(mm)

Code	Range (inside diameter of RTJ ring groove)	Range (outside diameter of RTJ ring groove)	Accuracy	Type	L	a	b	c	d	e	Data output cable (optional)
1179-300	10-300mm/0.4-12"	25-300mm/1-12"	±0.06mm	A	410	63.5	4.5	17	25	10	7315-25 (receiver is needed) page 5, 7214-25 page 11, 7302-21 page 20
1179-600	10-600mm/0.4-24"	25-600mm/1-24"	±0.07mm	B	770	65.5	4.5	24	25	10	7315-22 (receiver is needed) page 5, 7214-22 page 11, 7302-22 page 20
1179-1000	15-1000mm/0.6-40"	30-1000mm/1.2-40"	±0.09mm	B	1220	90	5	31	30	15	

Built-in wireless (receiver code 7315-2/3/6/7/8/9 is needed)

(mm)

Code	Range (inside diameter of RTJ ring groove)	Range (outside diameter of RTJ ring groove)	Accuracy	Type	L	a	b	c	d	e
1179-300WL	10-300mm/0.4-12"	25-300mm/1-12"	±0.06mm	A	410	63.5	4.5	17	25	10
1179-600WL	10-600mm/0.4-24"	25-600mm/1-24"	±0.07mm	B	770	65.5	4.5	24	25	10

DIGITAL CALIPERS WITH INTERCHANGEABLE BALL TIPS

DATA OUTPUT

2

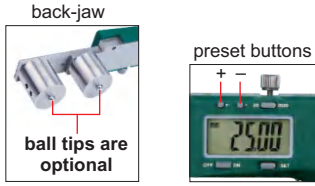

- Non waterproof
- Resolution 0.01mm/0.0005"
- Buttons: on/off, set, mm/inch, preset (+, -)
- Automatic power off, move the digital unit to turn on power
- Battery CR2032
- Made of stainless steel
- Optional accessory: ball tips

With data interface (optional data output cable: code 7315-25 receiver is needed page 5, 7214-25 page 11, 7302-21 page 20)

Code	Range	Accuracy
1527-3001	(22.22+D)~300mm*	±0.03mm

Built-in wireless (receiver code 7315-2/3/6/7/8/9 is needed)

Code	Range	Accuracy
1527-3001WL	(22.22+D)~300mm*	±0.03mm

*"D" is the diameter of ball tips.



1527-3001

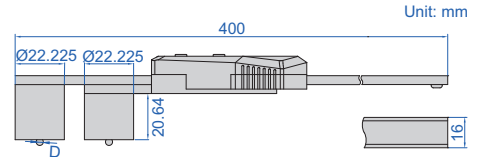

Ball tips (optional, supplied in pair)



Code	Diameter (D)	Accuracy of diameter	Type	Material
1527-T101	1/16" (Ø1.5875mm)	±0.005mm	A	ruby
1527-T102	1/8" (Ø3.175mm)	±0.005mm	B	stainless steel
1527-T103	3/16" (Ø4.7625mm)	±0.005mm	B	stainless steel
1527-T104	1/4" (Ø6.35mm)	±0.005mm	B	stainless steel
1527-T105	3/8" (Ø9.525mm)	±0.005mm	B	stainless steel
1527-T106	1/2" (Ø12.7mm)	±0.005mm	B	stainless steel

DIGITAL CALIPERS WITH INTERCHANGEABLE BALL TIPS

DATA OUTPUT

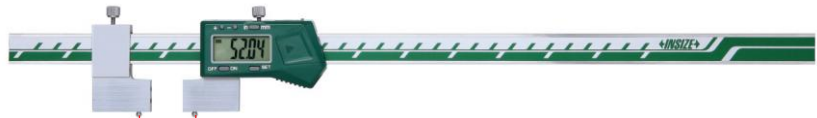
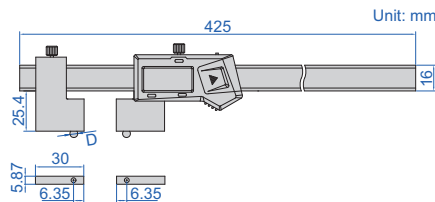

ball tips are optional

1528-3001



- Non waterproof
- Resolution 0.01mm/0.0005"
- Buttons: on/off, set, mm/inch, preset (+, -)
- Automatic power off, move the digital unit to turn on power
- Battery CR2032
- Made of stainless steel
- Optional accessory: ball tips

With data interface (optional data output cable: code 7315-25 receiver is needed page 5, 7214-25 page 11, 7302-21 page 20)

Code	Range	Accuracy
1528-3001	(12.7+D)~300mm*	±0.03mm

Built-in wireless (receiver code 7315-2/3/6/7/8/9 is needed)

Code	Range	Accuracy
1528-3001WL	(12.7+D)~300mm*	±0.03mm

*"D" is the diameter of ball tips.

Ball tips (optional, supplied in pair)



Code	Diameter (D)	Accuracy of diameter	Type	Material
1527-T101	1/16" (Ø1.5875mm)	±0.005mm	A	ruby
1527-T102	1/8" (Ø3.175mm)	±0.005mm	B	stainless steel
1527-T103	3/16" (Ø4.7625mm)	±0.005mm	B	stainless steel
1527-T104	1/4" (Ø6.35mm)	±0.005mm	B	stainless steel
1527-T105	3/8" (Ø9.525mm)	±0.005mm	B	stainless steel
1527-T106	1/2" (Ø12.7mm)	±0.005mm	B	stainless steel

RELATIVE PRODUCT: CRIMP HEIGHT
MICROMETER (CODE 3266-25BA, 3566-25BA)

 DATA
OUTPUT

DIGITAL CRIMP HEIGHT CALIPERS

- Non waterproof
- Measure crimp height
- Resolution: 0.01mm/0.0005"
- Buttons: on/off, zero, mm/inch
- Automatic power off, move the digital unit to turn on power
- Battery CR2032, meet DIN862
- Made of stainless steel



1165-150A

 With data interface (optional data output cable:
code 7315-25 receiver is needed page 5,
7214-25 page 11, 7302-21 page 20)

Code	Range	Accuracy
1165-150A	0-150mm/0-6"	±0.03mm

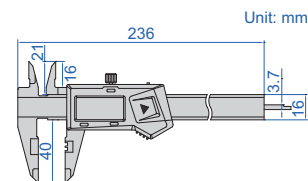
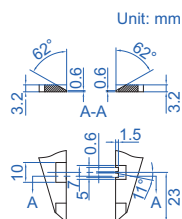

Built-in wireless

(receiver code 7315-2/3/6/7/8/9 is needed)

Code	Range	Accuracy
1165-150AWL	0-150mm/0-6"	±0.03mm

 DATA
OUTPUT

DIGITAL CALIPERS WITH LARGE MEASURING FACES



1172-200

- Non waterproof
- Measure diameter of wire ropes, and thickness of soft materials like rubber, sponge, etc.
- Resolution: 0.01mm/0.0005"
- Buttons: on/off, zero, mm/inch
- Automatic power off, move the digital unit to turn on power
- Battery CR2032
- Made of stainless steel

 With data interface (optional data output cable:
code 7315-25 receiver is needed page 5,
7214-25 page 11, 7302-21 page 20)

Code	Range	Accuracy
1172-200	0-200mm/0-8"	±0.07mm

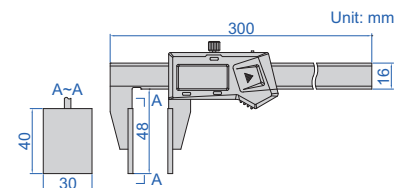

Built-in wireless

(receiver code 7315-2/3/6/7/8/9 is needed)

Code	Range	Accuracy
1172-200WL	0-200mm/0-8"	±0.07mm

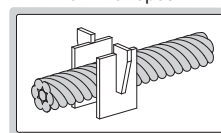
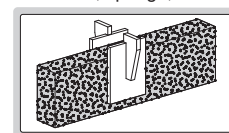
 measure diameter
of wire ropes

 measure thickness of
rubber, sponge, etc.

DIGITAL CALIPERS WITH DISK FACES

DATA
OUTPUT

2

- Non waterproof
- Measure thickness of soft sheets
- Resolution: 0.01mm/0.0005"
- Buttons: on/off, zero, mm/inch
- Automatic power off, move the digital unit to turn on power
- Battery CR2032
- Made of stainless steel



1533-150

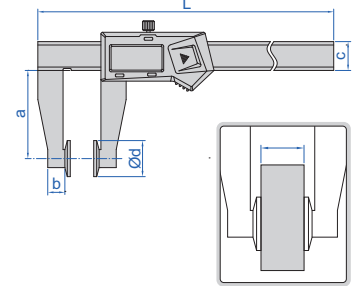

With data interface

(mm)

Code	Range	Accuracy	L	a	b	c	Ød	Data output cable (optional)
1533-150	0-150mm/0-6"	±0.04mm	245	50	11	16	20	7315-25 (receiver is needed) page 5, 7214-25 page 11, 7302-21 page 20
1533-200	0-200mm/0-8"	±0.05mm	310	80	11	16	30	
1533-500	0-500mm/0-20"	±0.07mm	680	150	12.5	24	50	7315-22 (receiver is needed) page 5, 7214-22 page 11, 7302-22 page 20

Built-in wireless (receiver code 7315-2/3/6/7/8/9 is needed)

(mm)

Code	Range	Accuracy	L	a	b	c	Ød
1533-150WL	0-150mm/0-6"	±0.04mm	245	50	11	16	20
1533-200WL	0-200mm/0-8"	±0.05mm	310	80	11	16	30
1533-500WL	0-500mm/0-20"	±0.07mm	680	150	12.5	24	50

DIGITAL WALL THICKNESS CALIPERS

DATA
OUTPUT

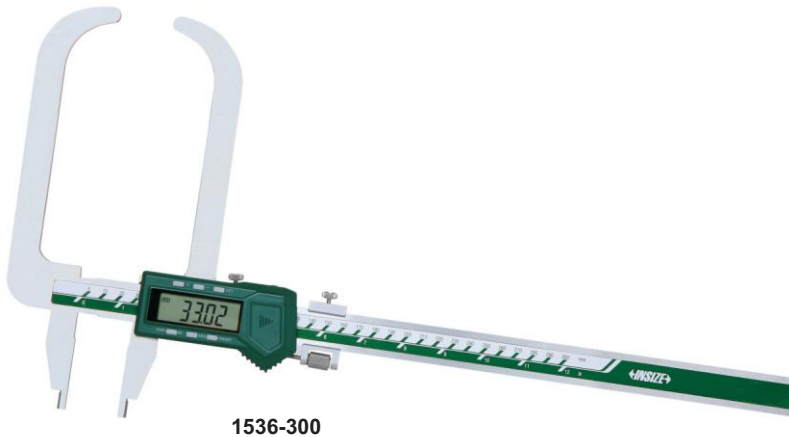

1536-300

- Non waterproof
- Measure wall thickness of helmets, domes and curved pots
- Resolution: 0.01mm/0.0005"
- Buttons: on/off, zero, mm/inch, ABS, data preset
- Automatic power off, move the digital unit to turn on power
- Battery CR2032
- Made of stainless steel

With data interface (optional data output cable: code 7315-22 receiver is needed page 5, 7214-22 page 11, 7302-22 page 20)

Code	Range	Accuracy
1536-300	0-300mm/0-12"	±0.05mm

Built-in wireless (receiver code 7315-2/3/6/7/8/9 is needed)

Code	Range	Accuracy
1536-300WL	0-300mm/0-12"	±0.05mm

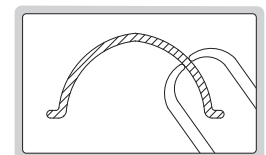
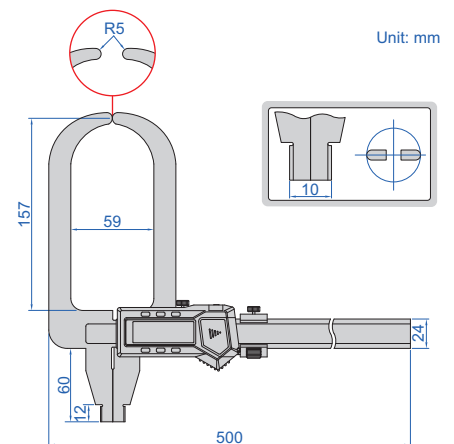

DIGITAL GEAR TOOTH CALIPERS

ATTENTION:
NO DATA OUTPUT

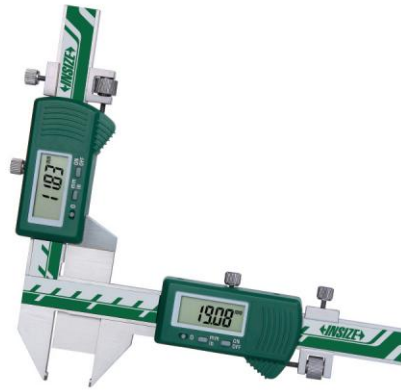
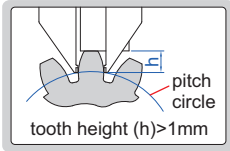

1181-M25A

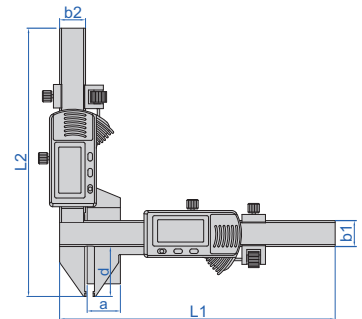

- Non waterproof
- Resolution: 0.01mm/0.0005"
- Carbide tips
- Measure the tooth thickness by positioning the tooth height (for tooth height > 1mm)
- Buttons: zero, on/off, mm/inch
- Automatic power off, move the digital unit to turn on power
- Battery CR2032
- Made of stainless steel

Code	Range	Accuracy of height measurement	Accuracy of thickness measurement	Total accuracy	L1	L2	a	b1	b2	d
1181-M25A	M1-25mm	±0.03mm	±0.03mm	±0.04mm	170mm	165.5mm	21mm	16mm	16mm	30.5mm
1181-M50A	M5-50mm	±0.03mm	±0.03mm	±0.04mm	220mm	190mm	50.5mm	16mm	16mm	55mm

GEAR TOOTH VERNIER CALIPER

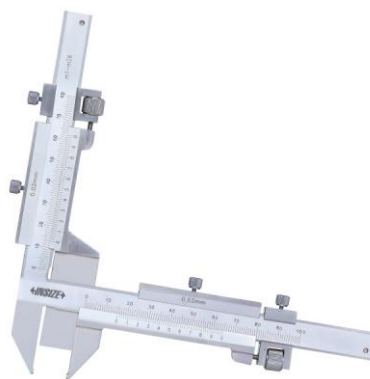
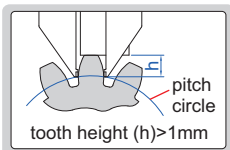

1281-M26A

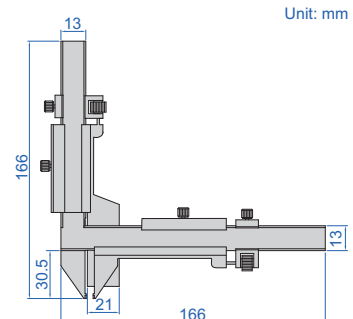

- Carbide tips
- Measure the tooth thickness by positioning the tooth height (for tooth height > 1mm)
- Made of stainless steel
- Satin chrome plated reading surface

Code	Range	Graduation	Accuracy of height measurement	Accuracy of thickness measurement	Total accuracy
1281-M26A	M1-26mm	0.02mm	±0.03mm	±0.03mm	±0.04mm

DIGITAL DISK BRAKE CALIPERS

RELATIVE PRODUCT: DISK BRAKE MICROMETER (CODE 3288-, 3588-)

DATA OUTPUT

2

- Non waterproof
- Measure thickness of disk brakes
- Resolution 0.01mm/0.0005"
- Buttons: on/off, zero, mm/inch
- Automatic power off, move the digital unit to turn on power
- Battery CR2032
- Made of stainless steel



1162-125A

With data interface (optional data output cable: code 7315-25 receiver is needed page 5, 7214-25 page 11, 7302-21 page 20)

Code	Range	Accuracy
1162-125A	0-125mm/0-5"	±0.05mm

Built-in wireless (receiver code 7315-2/3/6/7/8/9 is needed)

Code	Range	Accuracy
1162-125AWL	0-125mm/0-5"	±0.05mm

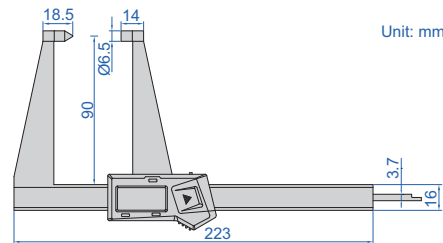

DIGITAL DISK BRAKE AND PAD CALIPERS

RELATIVE PRODUCT: DISK BRAKE MICROMETER (CODE 3288-, 3588-)

DATA OUTPUT

- Non waterproof
- Measure thickness of disk brakes and pad wear
- Resolution: 0.01mm/0.0005"
- Buttons: on/off, zero, mm/inch
- Automatic power off, move the digital unit to turn on power
- Battery CR2032
- Made of stainless steel



1167-150A

With data interface (optional data output cable: code 7315-25 receiver is needed page 5, 7214-25 page 11, 7302-21 page 20)

Code	Range	Accuracy
1167-150A	0-150mm/0-6"	±0.07mm

Built-in wireless (receiver code 7315-2/3/6/7/8/9 is needed)

Code	Range	Accuracy
1167-150AWL	0-150mm/0-6"	±0.07mm

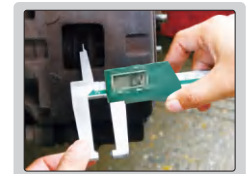
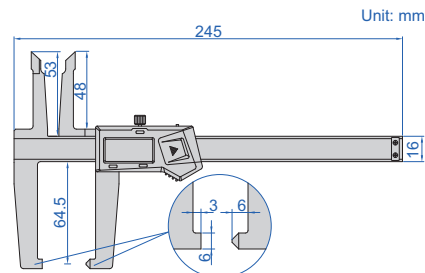

RELATIVE PRODUCT: DISK BRAKE MICROMETER (CODE 3288-, 3588-)

DATA OUTPUT

DIGITAL DRUM BRAKE CALIPERS

2



1168-300A

- Non waterproof
- Measure internal and external diameter of drum brakes
- Resolution 0.01mm/0.0005"
- Buttons: on/off, zero, mm/inch
- Automatic power off, move the digital unit to turn on power
- Battery CR2032
- Made of stainless steel

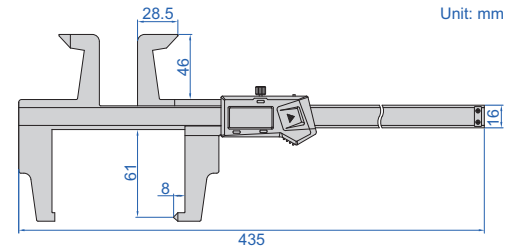

With data interface (optional data output cable: code 7315-25 receiver is needed page 5, 7214-25 page 11, 7302-21 page 20)

Code	Range	Accuracy
1168-300A	0-300mm/0-12"	±0.07mm

Built-in wireless (receiver code 7315-2/3/6/7/8/9 is needed)

Code	Range	Accuracy
1168-300AWL	0-300mm/0-12"	±0.07mm



DATA OUTPUT

DIGITAL DRUM BRAKE CALIPER

calibration block (included)



1538-300

- Non waterproof
- Measure internal diameter of drum brakes
- Resolution: 0.01mm/0.0005"
- Buttons: on/off, zero, mm/inch
- Automatic power off, move the digital unit to turn on power
- Battery CR2032
- Data output
- Made of stainless steel
- Optional accessory: wireless transmitter code 7315-22 (receiver is needed) page 5, bluetooth transmitter code 7214-22 page 11, data output cable code 7302-22 page 20

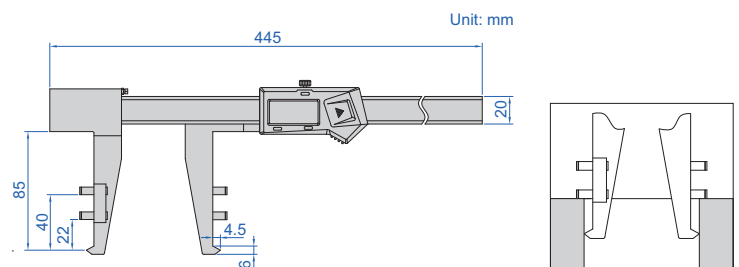

Code	Range	Accuracy
1538-300	30-300mm/1.2-12"	±0.05mm

DIGITAL ARC RADIUS CALIPERS

REFER TO PAGE 238
FOR DETAILS



1189-200B

DIGITAL SCRIBING CALIPERS

REFER TO PAGE 479
FOR DETAILS



1166-150A

KEYWAY SYMMETRY DIGITAL CALIPERS

REFER TO PAGE 241
FOR DETAILS



1531-60

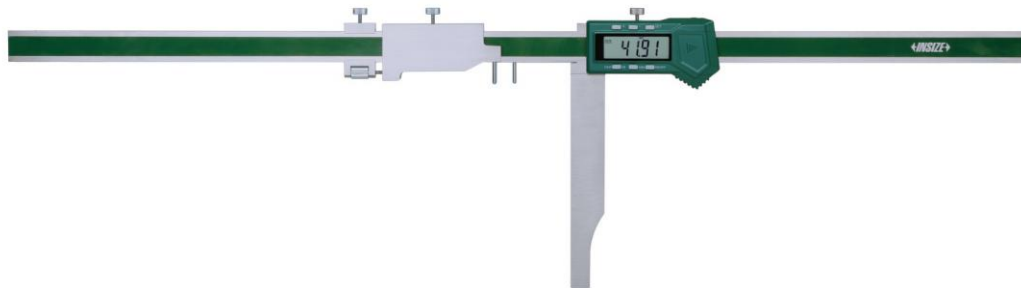

1531-200



Digital Depth Gauges
Page 85-89



Dial Depth Gauges
Page 89



Vernier Depth Gauges
Page 90-92



Extension Bases
Page 92



Mini Depth Gauges
Page 92-93



Depth Gauges
Page 94-97



Depth Micrometers
Page 98-99



Measuring Tools Dynamometers
Page 99



Depth Micrometer Checkers
Page 100

IP67 WATERPROOF DIGITAL DEPTH GAUGES

ATTENTION: NO DATA OUTPUT

ATTENTION: IT IS NECESSARY TO SET ZERO AFTER POWER ON EACH TIME

IP67
WATERPROOF

- IP67 dust/waterproof
- Resolution: 0.01mm/0.0005"
- Button function: zero, on/off, mm/inch, ABS/REL, hold
- Meet DIN862
- Battery CR2032
- Made of stainless steel



1149-150

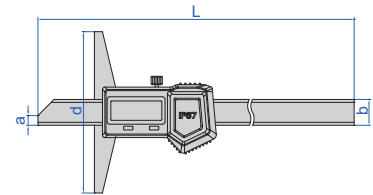

Code	Range	Accuracy	L	a	b	d
1149-150	0-150mm/0-6"	±0.03mm	240mm	6mm	16mm	100mm
1149-200	0-200mm/0-8"	±0.03mm	290mm	6mm	16mm	100mm
1149-300	0-300mm/0-12"	±0.03mm	390mm	6mm	16mm	150mm

DIGITAL DEPTH GAUGES (STANDARD TYPE)

POPULAR MODEL

DATA OUTPUT

- Non waterproof
- Buttons: on/off, zero, mm/inch
- Automatic power off, move the digital unit to turn on power
- Meet DIN862 (except 0-500mm/0-20", 0-1000mm/0-40", 0-1500mm/0-60")
- Battery CR2032
- Made of stainless steel



1141-150A

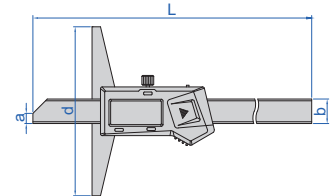

With data interface

Code	Range	Resolution	Accuracy	L	a	b	d	Data output cable (optional)
1141-150A	0-150mm/0-6"	0.01mm/0.0005"	±0.03mm	230	6	14.5	100	7315-25 (receiver is needed) page 5, 7214-25 page 11, 7302-21 page 20
1141-200A	0-200mm/0-8"	0.01mm/0.0005"	±0.03mm	280	6	14.5	100	
1141-300A	0-300mm/0-12"	0.01mm/0.0005"	±0.03mm	380	6	14.5	150	
1141-500A	0-500mm/0-20"	0.01mm/0.0005"	±0.05mm	585	7	15	150	7315-22 (receiver is needed) page 5, 7214-22 page 11, 7302-22 page 20
1141-5001A	0-500mm/0-20"	0.01mm/0.0005"	±0.05mm	585	7	15	200	
1141-1000A	0-1000mm/0-40"	0.01mm/0.0005"	±0.07mm	1188	7	18	150	
1141-10001A	0-1000mm/0-40"	0.01mm/0.0005"	±0.07mm	1188	7	18	200	
1141-10002A	0-1000mm/0-40"	0.01mm/0.0005"	±0.07mm	1188	7	18	250	
1141-10003A	0-1000mm/0-40"	0.01mm/0.0005"	±0.07mm	1188	7	18	300	
1141-1500A	0-1500mm/0-60"	0.01mm/0.0005"	±0.11mm	1695	7	18	200	

Built-in wireless (receiver code 7315-2/3/6/7/8/9 is needed)

Code	Range	Resolution	Accuracy	L	a	b	d
1141-150AWL	0-150mm/0-6"	0.01mm/0.0005"	±0.03mm	230mm	6mm	14.5mm	100mm
1141-200AWL	0-200mm/0-8"	0.01mm/0.0005"	±0.03mm	280mm	6mm	14.5mm	100mm
1141-300AWL	0-300mm/0-12"	0.01mm/0.0005"	±0.03mm	380mm	6mm	14.5mm	150mm
1141-500AWL	0-500mm/0-20"	0.01mm/0.0005"	±0.05mm	585mm	7mm	15mm	150mm
1141-5001AWL	0-500mm/0-20"	0.01mm/0.0005"	±0.05mm	585mm	7mm	15mm	200mm
1141-1000AWL	0-1000mm/0-40"	0.01mm/0.0005"	±0.07mm	1188mm	7mm	18mm	150mm
1141-10001AWL	0-1000mm/0-40"	0.01mm/0.0005"	±0.07mm	1188mm	7mm	18mm	200mm
1141-10002AWL	0-1000mm/0-40"	0.01mm/0.0005"	±0.07mm	1188mm	7mm	18mm	250mm
1141-10003AWL	0-1000mm/0-40"	0.01mm/0.0005"	±0.07mm	1188mm	7mm	18mm	300mm
1141-1500AWL	0-1500mm/0-60"	0.01mm/0.0005"	±0.11mm	1695mm	7mm	18mm	200mm

**DATA
OUTPUT**

DIGITAL DEPTH GAUGES WITH MOUNTING HOLES FOR EXTENSION BASE

- Non waterproof
- Resolution: 0.01mm/0.0005"
- Buttons: on/off, zero, mm/inch
- Automatic power off, move the digital unit to turn on power
- Meet DIN862
- Battery CR2032
- Made of stainless steel
- Optional accessory:
extension base (code 6141)

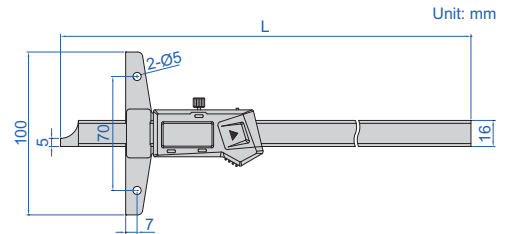
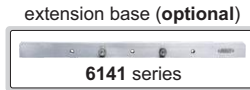
1147-300

With data interface (optional data output cable:
code 7315-25 receiver is needed page 5,
7214-25 page 11, 7302-21 page 20)

Code	Range	Accuracy	L
1147-150	0-150mm/0-6"	±0.03mm	237mm
1147-200	0-200mm/0-8"	±0.03mm	287mm
1147-300	0-300mm/0-12"	±0.03mm	403mm
1147-500	0-500mm/0-20"	±0.05mm	605mm
1147-700	0-700mm/0-28"	±0.06mm	805mm

Built-in wireless (receiver code 7315-2/3/6/7/8/9 is needed)

Code	Range	Accuracy	L
1147-150WL	0-150mm/0-6"	±0.03mm	237mm
1147-200WL	0-200mm/0-8"	±0.03mm	287mm
1147-300WL	0-300mm/0-12"	±0.03mm	403mm
1147-500WL	0-500mm/0-20"	±0.05mm	605mm
1147-700WL	0-700mm/0-28"	±0.06mm	805mm

**DATA
OUTPUT**

DIGITAL HOOK DEPTH GAUGES

- Non waterproof
- Resolution: 0.01mm/0.0005"
- Buttons: on/off, zero, mm/inch
- Automatic power off, move the digital unit to turn on power
- Battery CR2032
- Made of stainless steel

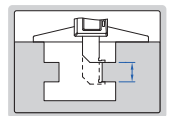
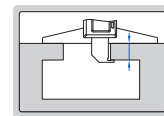
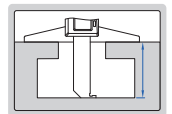

1142-150A

With data interface

Code	Range	Accuracy	L	d	a	b	c	Data output cable (optional)
1142-150A	0-150mm/0-6"	±0.03mm	230mm	100mm	5mm	2mm	14.5mm	7315-25 (receiver is needed) page 5, 7214-25 page 11, 7302-21 page 20
1142-200A	0-200mm/0-8"	±0.03mm	280mm	100mm	5mm	2mm	14.5mm	
1142-300A	0-300mm/0-12"	±0.04mm	380mm	150mm	5mm	2mm	14.5mm	
1142-500A	0-500mm/0-20"	±0.05mm	585mm	150mm	8mm	3mm	15mm	7315-22 (receiver is needed) page 5, 7214-22 page 11, 7302-22 page 20
1142-5001A	0-500mm/0-20"	±0.05mm	585mm	200mm	8mm	3mm	15mm	
1142-1000A	0-1000mm/0-40"	±0.07mm	1188mm	150mm	10mm	4mm	18mm	
1142-10001A	0-1000mm/0-40"	±0.07mm	1188mm	200mm	10mm	4mm	18mm	
1142-10002A	0-1000mm/0-40"	±0.07mm	1188mm	250mm	10mm	4mm	18mm	

Built-in wireless (receiver code 7315-2/3/6/7/8/9 is needed)

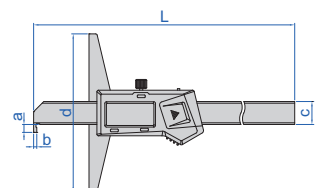
Code	Range	Accuracy	L	d	a	b	c
1142-150AWL	0-150mm/0-6"	±0.03mm	230mm	100mm	5mm	2mm	14.5mm
1142-200AWL	0-200mm/0-8"	±0.03mm	280mm	100mm	5mm	2mm	14.5mm
1142-300AWL	0-300mm/0-12"	±0.04mm	380mm	150mm	5mm	2mm	14.5mm
1142-500AWL	0-500mm/0-20"	±0.05mm	585mm	150mm	8mm	3mm	15mm
1142-5001AWL	0-500mm/0-20"	±0.05mm	585mm	200mm	8mm	3mm	15mm
1142-1000AWL	0-1000mm/0-40"	±0.07mm	1188mm	150mm	10mm	4mm	18mm
1142-10001AWL	0-1000mm/0-40"	±0.07mm	1188mm	200mm	10mm	4mm	18mm
1142-10002AWL	0-1000mm/0-40"	±0.07mm	1188mm	250mm	10mm	4mm	18mm



DIGITAL DOUBLE HOOK DEPTH GAUGES

DATA OUTPUT

- Non waterproof
- Resolution: 0.01mm/0.0005"
- Buttons: on/off, zero, mm/inch
- Automatic power off, move the digital unit to turn on power
- Meet DIN862
- Battery CR2032
- Made of stainless steel



1144-150A

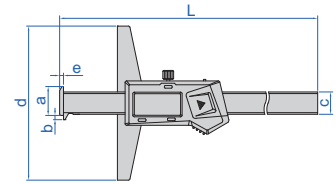

With data interface

(mm)

Code	Range	Accuracy	L	d	a	b	c	e	Data output cable (optional)
1144-150A	0-150mm/0-6"	±0.03mm	233	100	21.5	3.5	14.5	2.5	7315-25 (receiver is needed) page 5, 7214-25 page 11, 7302-21 page 20
1144-200A	0-200mm/0-8"	±0.03mm	283	100	21.5	3.5	14.5	2.5	
1144-300A	0-300mm/0-12"	±0.03mm	383	150	21.5	3.5	14.5	2.5	
1144-500A	0-500mm/0-20"	±0.05mm	585	150	25	5	15	3	7315-22 (receiver is needed) page 5, 7214-22 page 11, 7302-22 page 20
1144-5001A	0-500mm/0-20"	±0.05mm	585	200	25	5	15	3	
1144-1000A	0-1000mm/0-40"	±0.07mm	1188	150	32	7	18	4	
1144-10001A	0-1000mm/0-40"	±0.07mm	1188	200	32	7	18	4	
1144-10002A	0-1000mm/0-40"	±0.07mm	1188	250	32	7	18	4	

Built-in wireless (receiver code 7315-2/3/6/7/8/9 is needed)

Code	Range	Accuracy	L	d	a	b	c	e
1144-150AWL	0-150mm/0-6"	±0.03mm	233mm	100mm	21.5mm	3.5mm	14.5mm	2.5mm
1144-200AWL	0-200mm/0-8"	±0.03mm	283mm	100mm	21.5mm	3.5mm	14.5mm	2.5mm
1144-300AWL	0-300mm/0-12"	±0.03mm	383mm	150mm	21.5mm	3.5mm	14.5mm	2.5mm
1144-500AWL	0-500mm/0-20"	±0.05mm	585mm	150mm	25mm	5mm	15mm	3mm
1144-5001AWL	0-500mm/0-20"	±0.05mm	585mm	200mm	25mm	5mm	15mm	3mm
1144-1000AWL	0-1000mm/0-40"	±0.07mm	1188mm	150mm	32mm	7mm	18mm	4mm
1144-10001AWL	0-1000mm/0-40"	±0.07mm	1188mm	200mm	32mm	7mm	18mm	4mm
1144-10002AWL	0-1000mm/0-40"	±0.07mm	1188mm	250mm	32mm	7mm	18mm	4mm

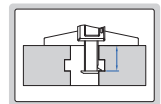
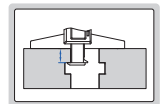

DIGITAL DOUBLE HOOK DEPTH GAUGE

DATA OUTPUT

- Non waterproof
- Resolution: 0.01mm/0.0005"
- Buttons: on/off, zero, mm/inch, ABS/INC, data hold, TOL, set
- ABS/INC is for absolute and incremental measurement
- TOL is for tolerance measurement
- Made of stainless steel
- LR44 battery, data output
- Supplied with gauge block for zero setting
- Optional accessory: extension base, wireless transmitter code 7315-1150 (receiver is needed) page 7, data output cable (keyboard format) code 7302-SPC7 page 22

Code	Range	Accuracy
1540-300	0-300mm/0-12"	±0.04mm

Extension base (optional)

Code	L
1540-L300	300mm
1540-L400	400mm
1540-L500	500mm
1540-L600	600mm
1540-L800	800mm

gauge block for zero setting (included)



1540-300

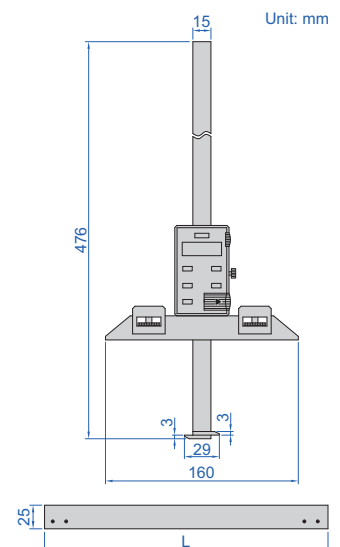

Unit: mm

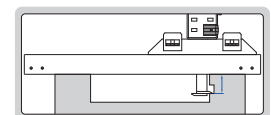
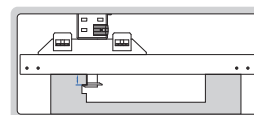



MEASURE DEPTH OF SMALL HOLES (>Ø4mm)

DATA OUTPUT

DIGITAL DEPTH GAUGES WITH ROUND DEPTH BAR

MEASURE WIDTH AND DEPTH OF GROOVES INSIDE BORE

- Non waterproof
- Resolution: 0.01mm/0.0005"
- Supplied with three interchangeable points (flat, spherical, disk)
- Buttons: on/off, set, mm/inch, preset (+, -)
- Automatic power off, move the digital unit to turn on power
- Battery CR2032
- Made of stainless steel
- Optional accessory: extension base (code 6141, for 1148-120, 1148-120WL, 1148-200, 1148-200WL, 1148-300 and 1148-300WL)



1148-100S



1148-120

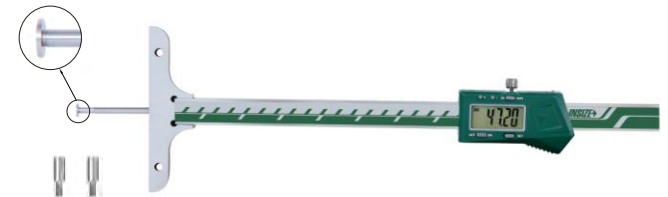

1148-200

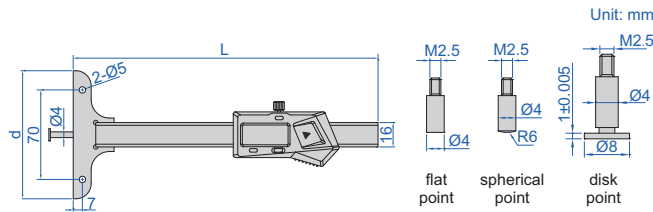

Unit: mm
flat point spherical point disk point

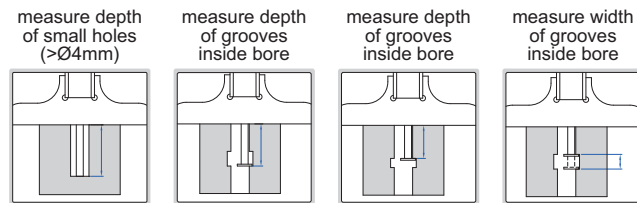

With data interface (optional data output cable: code 7315-25 receiver is needed page 5, 7214-25 page 11, 7302-21 page 20)

Code	Range*	Accuracy	L	d	Remark
1148-100S	0-100mm/0-4"	±0.02mm	200mm	45mm	
1148-100	0-100mm/0-4"	±0.02mm	200mm	85mm	
1148-120	0-120mm/0-4.7"	±0.03mm	300mm	101mm	one-hand use, with mounting holes for extension base
1148-200	0-200mm/0-8"	±0.03mm	300mm	101mm	with mounting holes for extension base
1148-300	0-300mm/0-12"	±0.04mm	400mm	101mm	with mounting holes for extension base

one-hand use of 1148-120 and 1148-120WL



extension base for 1148-120, 1148-120WL, 1148-200, 1148-200WL, 1148-300 and 1148-300WL (optional)



Built-in wireless (receiver code 7315-2/3/6/7/8/9 is needed)

Code	Range*	Accuracy	L	d	Remark
1148-100SWL	0-100mm/0-4"	±0.02mm	200mm	45mm	
1148-100WL	0-100mm/0-4"	±0.02mm	200mm	85mm	
1148-120WL	0-120mm/0-4.7"	±0.03mm	300mm	101mm	one-hand use, with mounting holes for extension base
1148-200WL	0-200mm/0-8"	±0.03mm	300mm	101mm	with mounting holes for extension base
1148-300WL	0-300mm/0-12"	±0.04mm	400mm	101mm	with mounting holes for extension base

1148-P103 (optional), measure width of bottom grooves inside blind hole

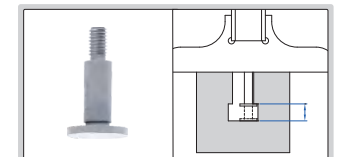

*When disk points are used, the range is reduced by 10mm

OPTIONAL DISK POINTS

Code	Description	H	Remark
1148-P101	0.5mm disk point	0.5±0.005mm	for narrow grooves
1148-P102	0.7mm disk point	0.7±0.005mm	for narrow grooves
1148-P103	1mm disk point	1±0.005mm	for grooves inside blind hole
1148-P104	0.5mm disk point	0.5±0.005mm	for grooves inside blind hole

1148-P101 (optional)

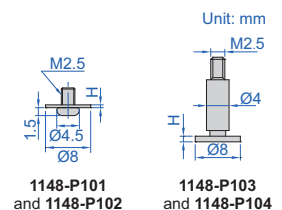

1148-P101 and 1148-P102

1148-P103 and 1148-P104

DIGITAL POINT DEPTH GAUGES

DATA
OUTPUT

3

- Non waterproof
- Resolution: 0.01mm/0.0005"
- Buttons: on/off, zero, mm/inch
- Automatic power off, move the digital unit to turn on power
- Meet DIN862
- Battery CR2032
- Made of stainless steel



1143-200A

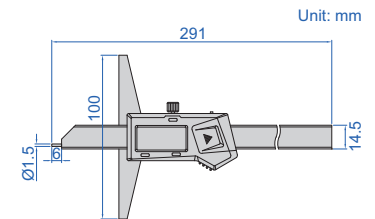

With data interface (optional data output cable: code 7315-25 receiver is needed page 5, 7214-25 page 11, 7302-21 page 20)

Code	Range	Accuracy
1143-200A	0-200mm/0-8"	±0.03mm

Built-in wireless (receiver code 7315-2/3/6/7/8/9 is needed)

Code	Range	Accuracy
1143-200AWL	0-200mm/0-8"	±0.03mm

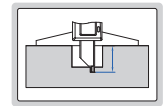

DIAL DEPTH GAUGES

SHOCK
PROOF



1340-150

- Shockproof dial indicator
- Made of stainless steel

Code	Range	Graduation	Accuracy	L
1340-150	0-150mm	0.02mm	±0.03mm	232mm
1340-200	0-200mm	0.02mm	±0.03mm	282mm
1340-300	0-300mm	0.02mm	±0.04mm	382mm

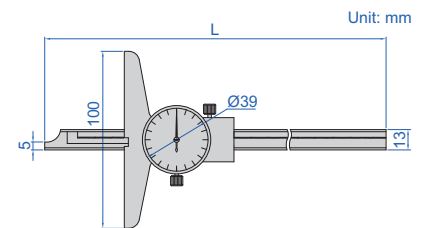

DIAL DEPTH GAUGES WITH ROUND BAR

SHOCK
PROOF

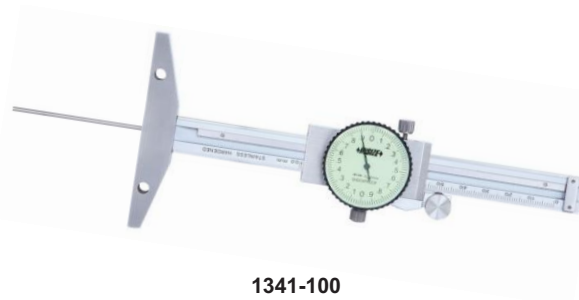

1341-100

- Shockproof dial indicator
- Dial indicator graduation: 0.02mm
- Made of stainless steel

Code	Range	Accuracy	L
1341-100	0-100mm	±0.02mm	181mm
1341-150	0-150mm	±0.03mm	234mm
1341-200	0-200mm	±0.03mm	284mm

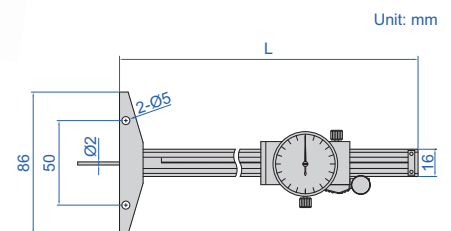

POPULAR MODEL

VERNIER DEPTH GAUGES (STANDARD TYPE)

- Made of stainless steel
- Satin chrome plated reading surface



1240-2001

Graduation 0.05mm

Code	Range	Accuracy	L	d	c
1240-150	0-150mm	±0.05mm	250mm	100mm	10mm
1240-200	0-200mm	±0.05mm	300mm	100mm	10mm
1240-300	0-300mm	±0.08mm	400mm	100mm	10mm
1240-500	0-500mm	±0.09mm	605mm	150mm	11mm

Graduation 0.02mm

Code	Range	Accuracy	L	d	c											
1240-1501	0-150mm	±0.03mm	250mm	100mm	10mm											
1240-2001	0-200mm	±0.03mm	300mm <td 100mm	10mm	1240-3001	0-300mm	±0.04mm	400mm	100mm	10mm	1240-5001	0-500mm	±0.05mm	605mm	150mm	11mm
1240-3001	0-300mm	±0.04mm	400mm	100mm	10mm											
1240-5001	0-500mm	±0.05mm	605mm	150mm	11mm											

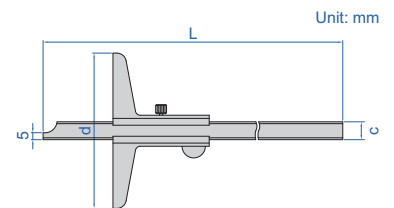

WITH MOUNTING HOLES FOR EXTENSION BASE

VERNIER DEPTH GAUGES



1247-2001

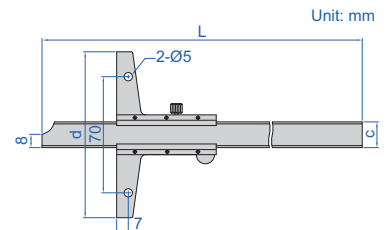

- Made of stainless steel
- Satin chrome plating finish on reading surface
- Optional accessory: extension base (code 6141)

extension base (optional)

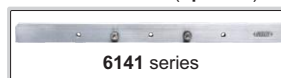

Range	L	c	d
0-150mm	240mm	16mm	100mm
0-200mm	290mm	16mm	100mm
0-300mm	390mm	16mm	100mm
0-600mm	704mm	16mm	150mm
0-1000mm	1140mm	16mm	200mm

Code	Range	Accuracy	Graduation
1247-150	0-150mm	±0.05mm	0.05mm
1247-200	0-200mm	±0.05mm	0.05mm
1247-300	0-300mm	±0.08mm	0.05mm
1247-600	0-600mm	±0.10mm	0.05mm
1247-1000	0-1000mm	±0.15mm	0.05mm

Code	Range	Accuracy	Graduation
1247-1501	0-150mm	±0.03mm	0.02mm
1247-2001	0-200mm	±0.03mm	0.02mm
1247-3001	0-300mm	±0.04mm	0.02mm
1247-6001	0-600mm	±0.05mm	0.02mm
1247-1001	0-1000mm	±0.07mm	0.02mm

VERNIER DEPTH GAUGES WITH FINE ADJUSTMENT

WITH MOUNTING HOLES FOR EXTENSION BASE



1249-1501

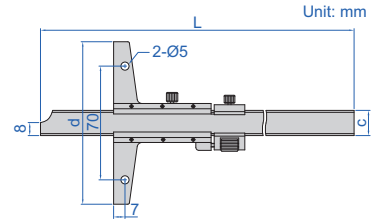

- With fine adjustment
- Made of stainless steel
- Satin chrome plating finish on reading surface
- Optional accessory: extension base (code **6141**)

extension base (optional)



Graduation 0.02mm

Code	Range	Accuracy
1249-1501	0-150mm	±0.03mm
1249-2001	0-200mm	±0.03mm
1249-3001	0-300mm	±0.04mm

Graduation 0.05mm

Code	Range	Accuracy
1249-150	0-150mm	±0.05mm
1249-200	0-200mm	±0.05mm
1249-300	0-300mm	±0.08mm

Range	L	c	d
0-150mm	256mm	16mm	100mm
0-200mm	306mm	16mm	100mm
0-300mm	406mm	16mm	100mm

VERNIER HOOK DEPTH GAUGES

WITH MOUNTING HOLES FOR EXTENSION BASE

extension base (optional)



1248-1501

- Made of stainless steel
- Satin chrome plating finish on reading surface
- Optional accessory: extension base (code **6141**)

Graduation 0.05mm

Code	Range	Accuracy	L
1248-150	0-150mm	±0.05mm	266mm
1248-200	0-200mm	±0.05mm	316mm
1248-300	0-300mm	±0.08mm	416mm

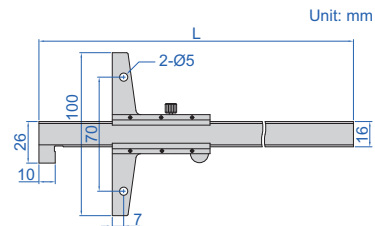

Graduation 0.02mm

Code	Range	Accuracy	L
1248-1501	0-150mm	±0.03mm	266mm
1248-2001	0-200mm	±0.03mm	316mm
1248-3001	0-300mm	±0.04mm	416mm

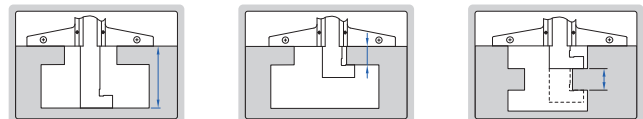

VERNIER HOOK DEPTH GAUGE

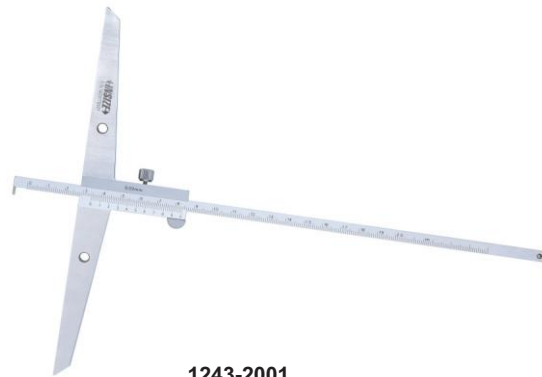

1243-2001

- Graduation 0.02mm
- Made of stainless steel
- Satin chrome plating finish on reading surface

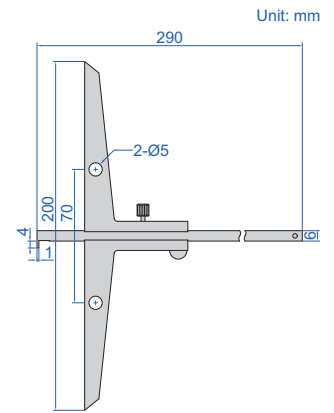

Unit: mm

3

Code	Range	Accuracy
1243-2001	0-200mm	±0.04mm

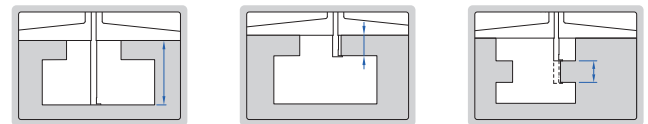

EXTENSION BASES



6141-260

- Supplied with two screws
- Made of stainless steel
- Suitable for depth gauges series 1147, 1148, 1247, 1248 and 1249

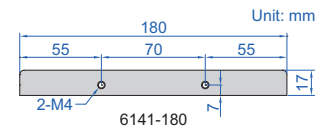

Unit: mm

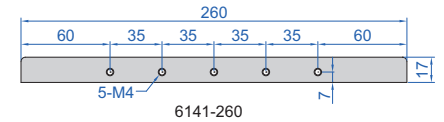
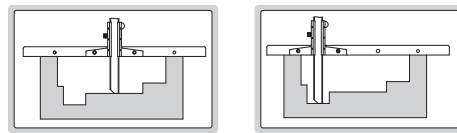

6141-260

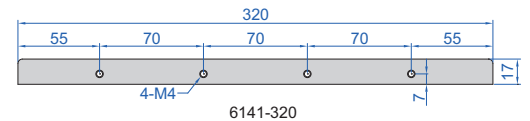

6141-320

Code	Length
6141-180	180mm
6141-260	260mm
6141-320	320mm
6141-600	600mm

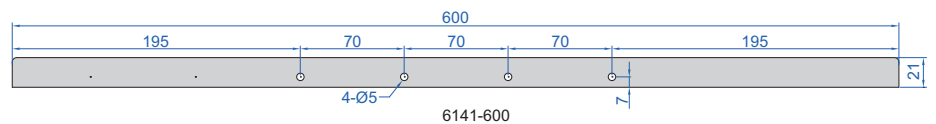

6141-600

MINI VERNIER DEPTH GAUGE

- Graduation: 0.1mm
- Made of stainless steel



1244-30

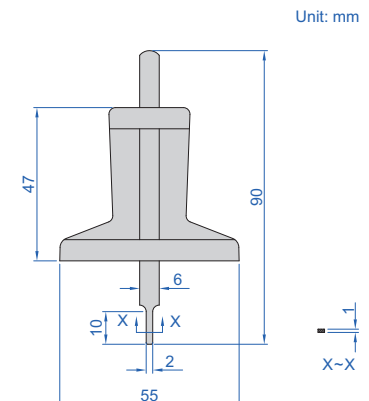

Unit: mm

Code	Range	Accuracy
1244-30	0-30mm	±0.10mm

MINI DIGITAL DEPTH GAUGES

DATA OUTPUT



- Non waterproof
- Measure depth of small groove and hole, also measure depth of tire tread
- Resolution: 0.01mm/0.0005"
- Buttons: on/off, zero, mm/inch
- Supplied with zero set surface
- Automatic power off, move the digital unit to turn on power
- Battery CR2032
- Made of stainless steel



1145-25A

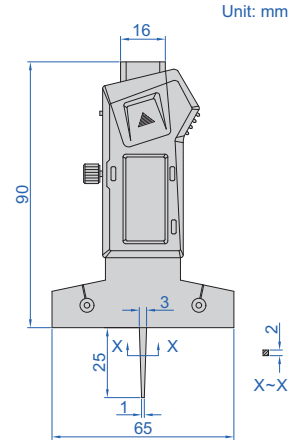

With data interface (optional data output cable: code 7315-25 receiver is needed page 5, 7214-25 page 11, 7302-21 page 20)

Code	Range	Accuracy
1145-25A	0-25mm/0-1"	±0.03mm

Built-in wireless (receiver code 7315-2/3/6/7/8/9 is needed)

Code	Range	Accuracy
1145-25AWL	0-25mm/0-1"	±0.03mm

MINI DIGITAL DEPTH GAUGES WITH ROUND BAR

DATA OUTPUT



- Non waterproof
- Measure depth of small groove and hole
- Resolution: 0.01mm/0.0005"
- Buttons: on/off, set, mm/inch, preset (+,-)
- Automatic power off, move the digital unit to turn on power
- Battery CR2032
- Made of stainless steel



1140-25

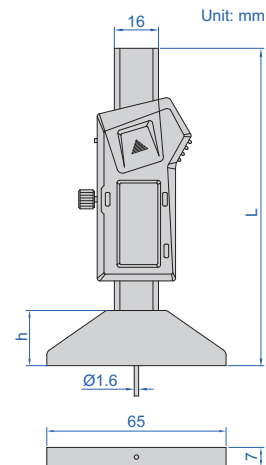

With data interface (optional data output cable: code 7315-25 receiver is needed page 5, 7214-25 page 11, 7302-21 page 20)

Code	Range	Accuracy	L	h
1140-25	0-25mm/0-1"	±0.02mm	114mm	20mm
1140-50	0-50mm/0-2"	±0.02mm	140mm	20mm
1140-100	0-100mm/0-4"	±0.02mm	190mm	20mm
1140-150	0-150mm/0-6"	±0.03mm	236mm	16mm

Built-in wireless (receiver code 7315-2/3/6/7/8/9 is needed)

Code	Range	Accuracy	L	h
1140-25WL	0-25mm/0-1"	±0.02mm	114mm	20mm
1140-50WL	0-50mm/0-2"	±0.02mm	140mm	20mm
1140-100WL	0-100mm/0-4"	±0.02mm	190mm	20mm
1140-150WL	0-150mm/0-6"	±0.03mm	236mm	16mm

DIAL DEPTH GAUGES

Unit: mm

- Accuracy: $\pm 0.017\text{mm}$
- Stainless steel base
- Pointed tip



2343-102

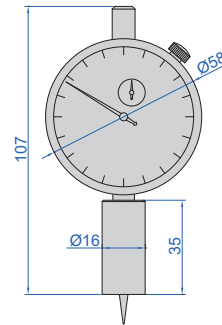

2343-101

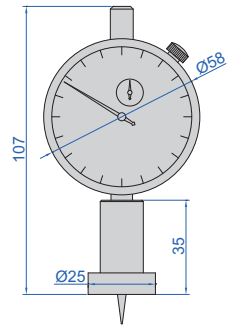

2343-102

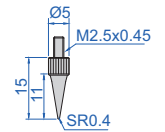

pointed tip

Code	Range	Dial indicator stroke	Dial indicator graduation	Base
2343-101	0-10mm	10mm	0.01mm	$\varnothing 16\text{mm}$
2343-102	0-10mm	10mm	0.01mm	$\varnothing 25\text{mm}$

DATA
OUTPUT

DIGITAL DEPTH GAUGES

Unit: mm

- Button function: on/off, zero, mm/inch, ABS, data preset, change measuring direction
- CR2032 battery, automatic power off (time is adjustable)
- Data output
- Stainless steel base
- Pointed tip
- Optional accessory:
wireless transmitter code **7315-50M** (receiver is needed) page 6,
bluetooth transmitter code **7214-50M** page 12,
data output cable code **7302-40M** page 21



2142-102

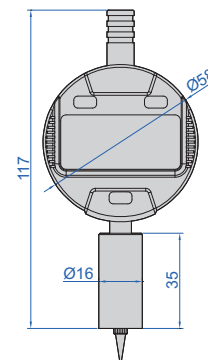

2142-101/2142-301

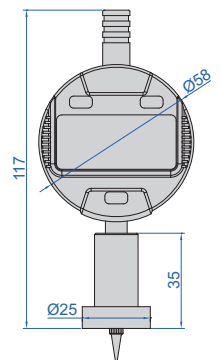

2142-102/2142-302

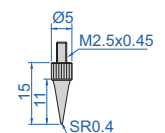

pointed tip

Code	Range	Digital indicator stroke	Digital indicator resolution	Accuracy	Base
2142-101	0-12.7mm/0-0.5"	12.7mm/0.5"	0.01mm/0.0005"	$\pm 20\mu\text{m}$	$\varnothing 16\text{mm}$
2142-102	0-12.7mm/0-0.5"	12.7mm/0.5"	0.01mm/0.0005"	$\pm 20\mu\text{m}$	$\varnothing 25\text{mm}$
2142-301	0-12.7mm/0-0.5"	12.7mm/0.5"	0.001mm/0.00005"	$\pm 5\mu\text{m}$	$\varnothing 16\text{mm}$
2142-302	0-12.7mm/0-0.5"	12.7mm/0.5"	0.001mm/0.00005"	$\pm 5\mu\text{m}$	$\varnothing 25\text{mm}$

DIAL DEPTH GAUGE

- Accuracy: $\pm 0.017\text{mm}$
- Stainless steel base
- Supplied with pointed tip and ball tip



2341-101A

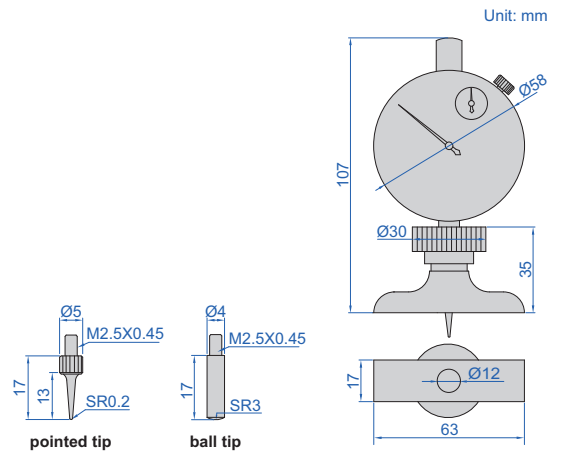

Code	Range	Dial indicator stroke	Dial indicator graduation
2341-101A	0-10mm	10mm	0.01mm

DIAL DEPTH GAUGES



2342-202

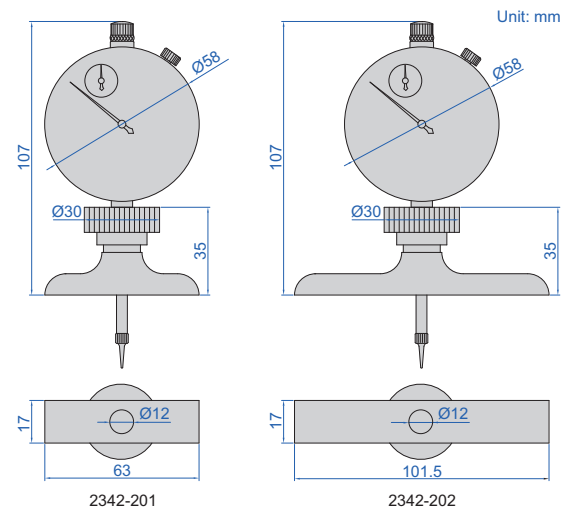

2141-10 (optional),
can be customized
according to workpieces

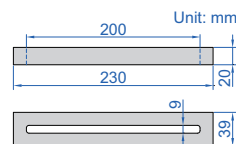

- Dial indicator graduation: 0.01mm
- Accuracy: $\pm 0.03\text{mm}$
- Stainless steel base
- Extension rods: 25mm (1pc), 50mm (1pc), 75mm (1pc), 100mm (2pcs)
- Supplied with pointed tip and ball tip
- Optional accessory:
granite extension holder (code 2141-10)

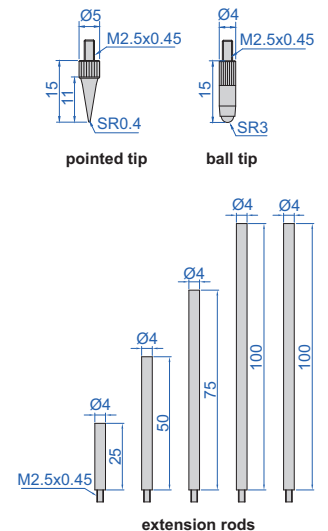
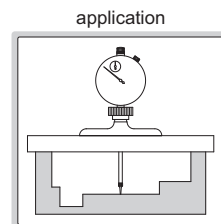

Code	Range	Dial indicator stroke	Base
2342-201	0-300mm	30mm	63×17mm
2342-202	0-300mm	30mm	101.5×17mm

DATA
OUTPUT

DIGITAL DEPTH GAUGES

3



2141-202A

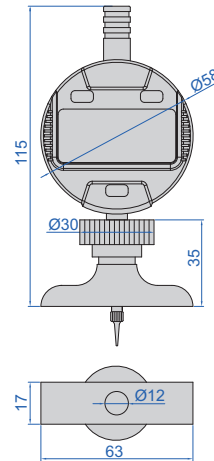

2141-201A/2141-301

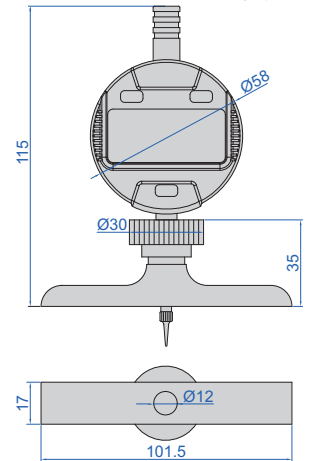

2141-202A/2141-302

Unit: mm

- Button function: on/off, zero, mm/inch, ABS, data preset, change measuring direction
- CR2032 battery, automatic power off (time is adjustable)
- Data output
- Stainless steel base
- Extension rods: 12.5mm (1pc), 25mm (1pc), 50mm (1pc), 75mm (1pc), 100mm (2pcs)
- Supplied with pointed tip and ball tip
- Optional accessory:
wireless transmitter code **7315-50M** (receiver is needed) page 6,
bluetooth transmitter code **7214-50M** page 12,
data output cable code **7302-40M** page 21,
granite extension holder (code **2141-10**)

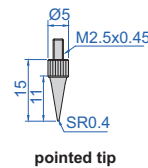

pointed tip

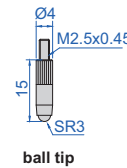

ball tip

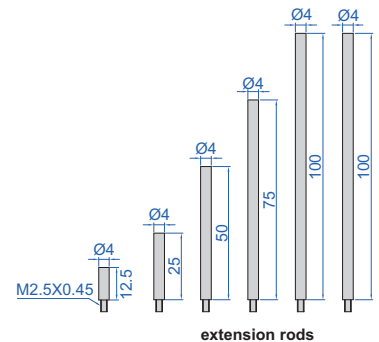

extension rods



2141-10 (optional),
can be customized
according to workpieces

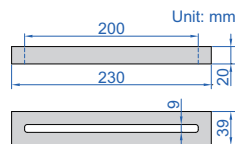

Unit: mm

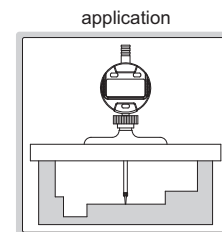

application

Code	Range	Digital indicator stroke	Digital indicator resolution	Accuracy	Base
2141-201A	0-300mm/0-12"	12.7mm/0.5"	0.01mm/0.0005"	±20µm	63×17mm
2141-202A	0-300mm/0-12"	12.7mm/0.5"	0.01mm/0.0005"	±20µm	101.5×17mm
2141-301	0-300mm/0-12"	12.7mm/0.5"	0.001mm/0.00005"	±5µm	63×17mm
2141-302	0-300mm/0-12"	12.7mm/0.5"	0.001mm/0.00005"	±5µm	101.5×17mm

DIGITAL DEPTH GAUGE (60° KNIFE EDGE BASE)

DATA OUTPUT

3

- Button function: on/off, zero, inch/mm, ABS, data preset, change measuring direction
- CR2032 battery, automatic power off (time is adjustable)
- Data output
- Stainless steel base with 60° knife edge
- Optional accessory: wireless transmitter code **7315-50M** (receiver is needed) page 6, bluetooth transmitter code **7214-50M** page 12, data output cable code **7302-40M** page 21



front view

side view

2143-101

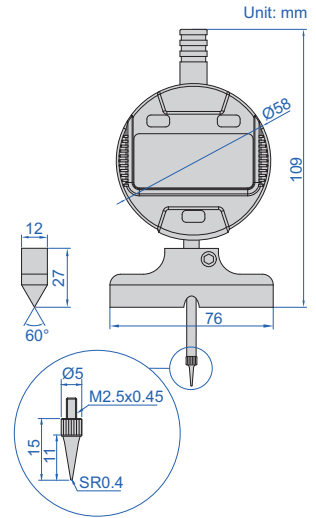

Code	Range	Digital indicator stroke	Digital indicator resolution	Accuracy
2143-101	0-12.7mm/0-0.5"	12.7mm/0.5"	0.01mm/0.0005"	±20µm

DIGITAL GROOVE GAUGES

DATA OUTPUT



2145-202

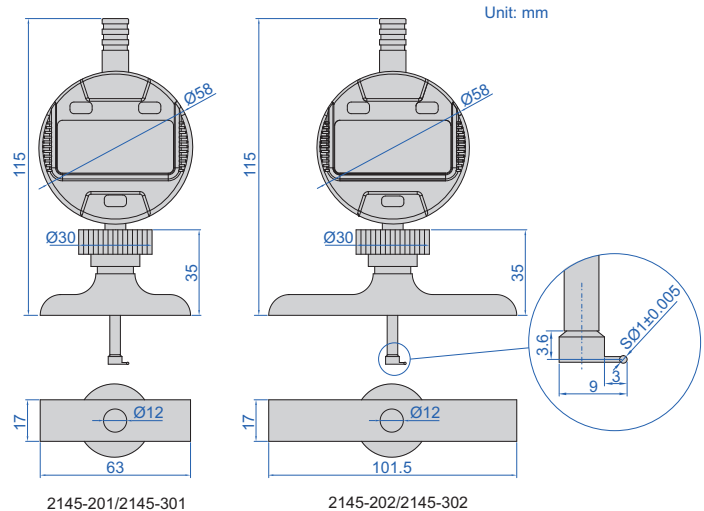

2145-201/2145-301

2145-202/2145-302

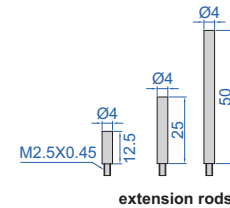

extension rods

measure width (b) and depth (a) of groove

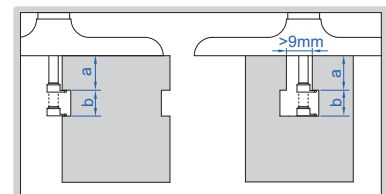

- Button function: on/off, zero, mm/inch, absolute/incremental measurement, data preset, change measuring direction
- CR2032 battery, automatic power off (time is adjustable)
- Data output
- Stainless steel base
- Supplied with extension rods: 12.5mm (1pc), 25mm (1pc), 50mm (1pc)
- Supplied with groove point
- Optional accessory: wireless transmitter code **7315-50M** (receiver is needed) page 6, bluetooth transmitter code **7214-50M** page 12, data output cable code **7302-40M** page 21

Code	Range (a)	Digital indicator stroke (b)	Digital indicator resolution	Accuracy	Base
2145-201	0-85mm/0-3.35"	12.7mm/0.5"	0.01mm/0.0005"	±20µm	63×17mm
2145-202	0-85mm/0-3.35"	12.7mm/0.5"	0.01mm/0.0005"	±20µm	101.5×17mm
2145-301	0-85mm/0-3.35"	12.7mm/0.5"	0.001mm/0.00005"	±5µm	63×17mm
2145-302	0-85mm/0-3.35"	12.7mm/0.5"	0.001mm/0.00005"	±5µm	101.5×17mm

DIGITAL DEPTH MICROMETERS

IP65
WATERPROOF

DATA
OUTPUT

- Resolution: 0.001mm/0.00005"
- Micrometer head accuracy: $\pm 3\mu\text{m}$
- Rod accuracy: $\pm(2+L/75)\mu\text{m}$, L is the measuring range in mm
- Button function: on/off, set, mm/inch, data transmit
- IP65 dust/waterproof
- Data output
- Automatic power off
- Rods with flat end
- Ratchet stop
- Optional accessory:
wireless transmitter code **7315-31** (receiver is needed) page 6,
bluetooth transmitter code **7214-31** page 12,
data output cable code **7302-31** page 20



3540-50

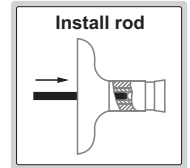

Code	Range	Rods	L
3540-25	0-25mm/0-1"	1 pc	101.5mm
3540-50	0-50mm/0-2"	2 pcs	101.5mm
3540-100	0-100mm/0-4"	4 pcs	101.5mm
3540-150	0-150mm/0-6"	6 pcs	101.5mm
3540-300	0-300mm/0-12"	12 pcs	101.5mm
3540-B25	0-25mm/0-1"	1 pc	63mm
3540-B50	0-50mm/0-2"	2 pcs	63mm
3540-B100	0-100mm/0-4"	4 pcs	63mm
3540-B150	0-150mm/0-6"	6 pcs	63mm
3540-B300	0-300mm/0-12"	12 pcs	63mm

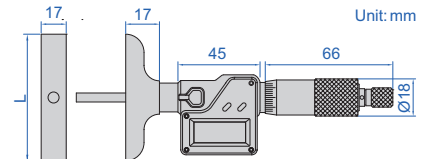
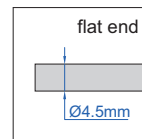

DEPTH MICROMETERS

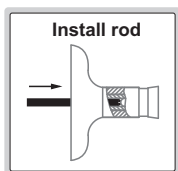

- Meet DIN863-2
- Graduation: 0.01mm
- Micrometer head accuracy: $\pm 3\mu\text{m}$
- Rod accuracy: $\pm(2+L/75)\mu\text{m}$, L is the measuring range in mm
- Rods with flat or spherical end
- Ratchet stop



3240-100

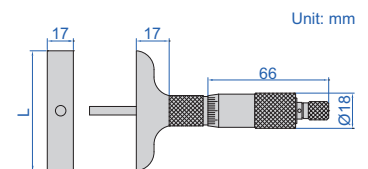

Flat end

Code	Range	Rods	L
3240-25	0-25mm	1 pc	101.5mm
3240-50	0-50mm	2 pcs	101.5mm
3240-75	0-75mm	3 pcs	101.5mm
3240-100	0-100mm	4 pcs	101.5mm
3240-150	0-150mm	6 pcs	101.5mm
3240-200	0-200mm	8 pcs	101.5mm
3240-300	0-300mm	12 pcs	101.5mm
3240-B25	0-25mm	1 pc	63mm
3240-B50	0-50mm	2 pcs	63mm
3240-B100	0-100mm	4 pcs	63mm
3240-B150	0-150mm	6 pcs	63mm
3240-B300	0-300mm	12 pcs	63mm

Spherical end

Code	Range	Rods	L
3240-25S	0-25mm	1 pc	101.5mm
3240-50S	0-50mm	2 pcs	101.5mm
3240-100S	0-100mm	4 pcs	101.5mm
3240-150S	0-150mm	6 pcs	101.5mm
3240-300S	0-300mm	12 pcs	101.5mm
3240-B25S	0-25mm	1 pc	63mm
3240-B50S	0-50mm	2 pcs	63mm
3240-B100S	0-100mm	4 pcs	63mm
3240-B150S	0-150mm	6 pcs	63mm
3240-B300S	0-300mm	12 pcs	63mm

DEPTH MICROMETERS



3241-100

- Meet DIN863-2
- Graduation: 0.01mm
- Micrometer head accuracy: $\pm 3\mu\text{m}$
- Rod accuracy: $\pm (2+L/75)\mu\text{m}$, L is the measuring range in mm
- Rods with flat end
- Ratchet stop

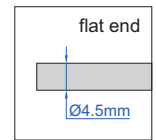
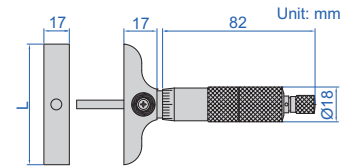

Code	Range	Rods	L
3241-25	0-25mm	1 pc	101.5mm
3241-50	0-50mm	2 pcs	101.5mm
3241-75	0-75mm	3 pcs	101.5mm
3241-100	0-100mm	4 pcs	101.5mm
3241-150	0-150mm	6 pcs	101.5mm
3241-200	0-200mm	8 pcs	101.5mm
3241-300	0-300mm	12 pcs	101.5mm
3241-B25	0-25mm	1 pc	63mm
3241-B50	0-50mm	2 pcs	63mm
3241-B100	0-100mm	4 pcs	63mm
3241-B150	0-150mm	6 pcs	63mm
3241-B300	0-300mm	12 pcs	63mm

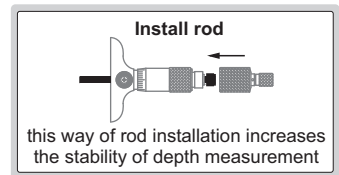

MEASURING TOOLS DYNAMOMETERS

REFER TO PAGE 187 FOR DETAILS



ISF-DGD15



check the measuring force of depth gauges



CYLINDER GAUGE BLOCKS FOR DEPTH MICROMETERS

- Made of special alloy steel, hardness HRC64, high stability, wear resistance and easy combination
- Meet ISO3650 grade 1



4179-25

Code	Length (L)
4179-25 *	25mm
4179-50 *	50mm
4179-75 *	75mm
4179-100 *	100mm
4179-125 *	125mm
4179-150 *	150mm
4179-175 *	175mm
4179-200 *	200mm
4179-225 *	225mm
4179-250 *	250mm
4179-275 *	275mm

* Supplied with manufacturer inspection certificate

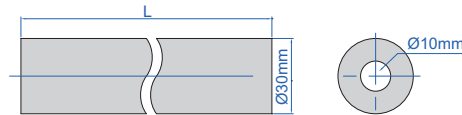

application



DEPTH MICROMETER CHECKERS

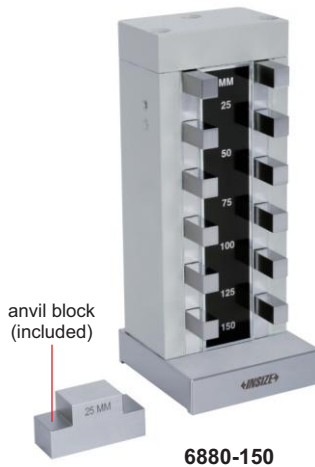

6880-150

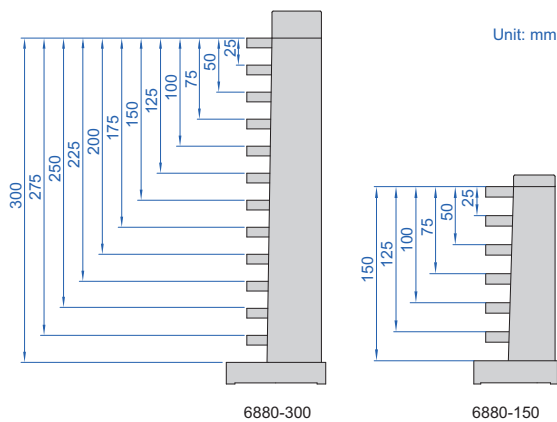

6880-300

6880-150

- To check depth micrometers and set zero
- Constructed with steel gauge blocks
- Supplied with anvil block

Code	Size	Range (mm)	Accuracy
6880-150 *	0-150mm	25, 50, 75, 100, 125, 150	±2µm
6880-300 *	0-300mm	25, 50, 75, 100, 125, 150, 175, 200, 225, 250, 275, 300	±3µm

* Supplied with manufacturer inspection certificate

application





Digital Height Gauges
Page 102-104



Dial Indicator Stands
Page 104



Height Gauges
Page 105-110



Height Gauge Checkers
Page 110



DATA OUTPUT

HIGH PRECISION DIGITAL HEIGHT GAUGES

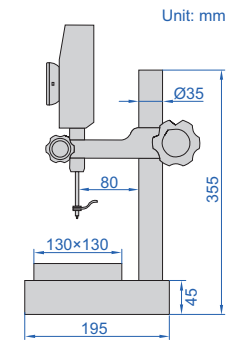
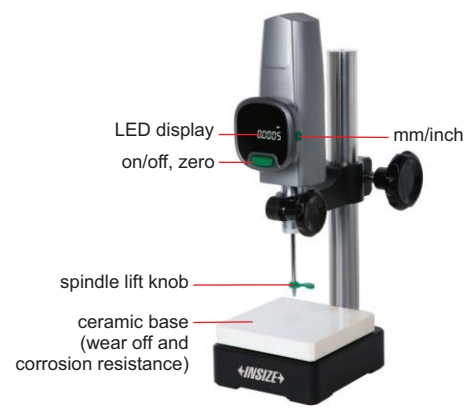

1155-505



power supplied by charge pal

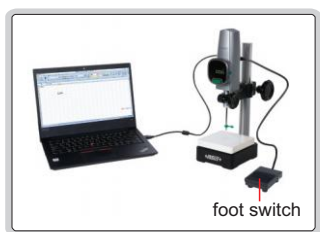

data transmitted to Excel without software; short press the foot switch to transmit data, long press to zero

measuring tips (included)

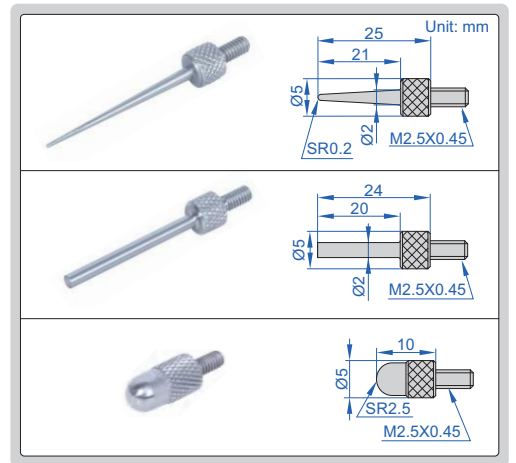

- High stability, high precision, high response speed (5000mm/s)
- High brightness LED display
- Ceramic base flatness: 1µm

Code	Range	Resolution	Accuracy (at 20°C)	Measuring force	Output	Power supply
1155-505	0~50mm	0.5µm/0.00002" (can switch to: 1µm/0.00005")	1.5µm	0.8~1.2N	USB	5V/1A (adapter or charge pal)
1155-510	0~50mm	0.1µm/0.000005" (can switch to: 1µm/0.00005")	1µm	0.8~1.2N	USB	5V/1A (adapter or charge pal)

OPTIONAL ACCESSORY

Contact point	code 6282
Charge pal	1155-5-POB
Data output cable (including foot switch)	1155-5-FOS

STANDARD DELIVERY

Main unit	1 pc
-----------	------

DIGITAL HEIGHT GAUGES

DATA OUTPUT



4



1157-501

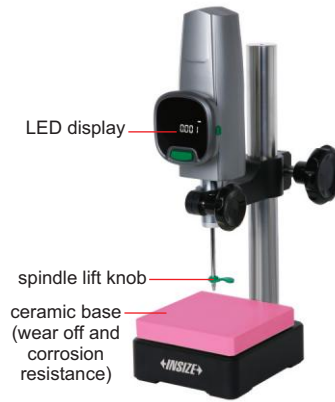
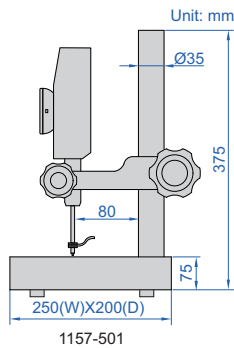

1157-502

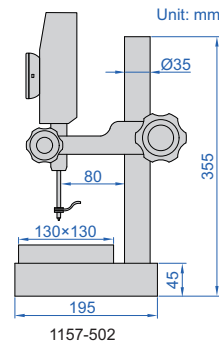

- Buttons: on/off, zero, mm/inch, max./min./max.-min.
- High response speed (5000mm/s)
- High brightness LED display



power supplied by charge pal

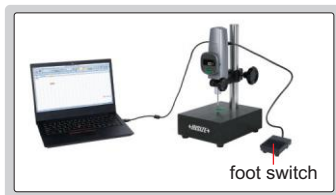

data transmitted to Excel without software; short press the foot switch to transmit data, long press to zero

measuring tips (included)

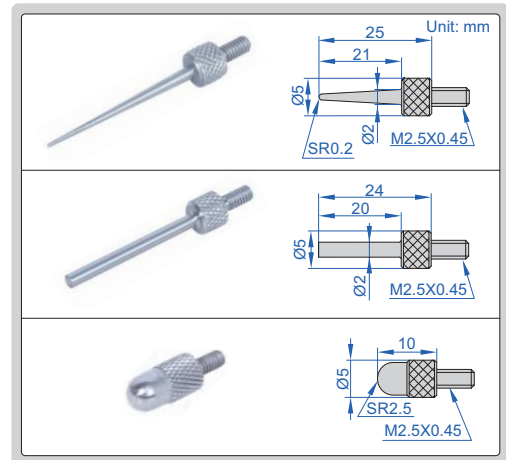

Code	Range	Resolution	Accuracy (at 20°C)	Measuring force	Output	Power supply	Base
1157-501	0~50mm	1µm/0.00005"	3µm	0.8~1.2N	USB	5V/1A (adapter or charge pal)	granite (flatness: 2µm)
1157-502	0~50mm	1µm/0.00005"	3µm	0.8~1.2N	USB	5V/1A (adapter or charge pal)	ceramic (flatness: 1µm)

OPTIONAL ACCESSORY

Contact point	code 6282
Charge pal	1155-5-POB
Data output cable (including foot switch)	1155-5-FOS

STANDARD DELIVERY

Main unit	1 pc
-----------	------



DATA OUTPUT

LARGE RANGE DIGITAL HEIGHT GAUGE

- High stability, high precision, high response speed (5000mm/s)
- High brightness LED display
- Granite base flatness: 3µm

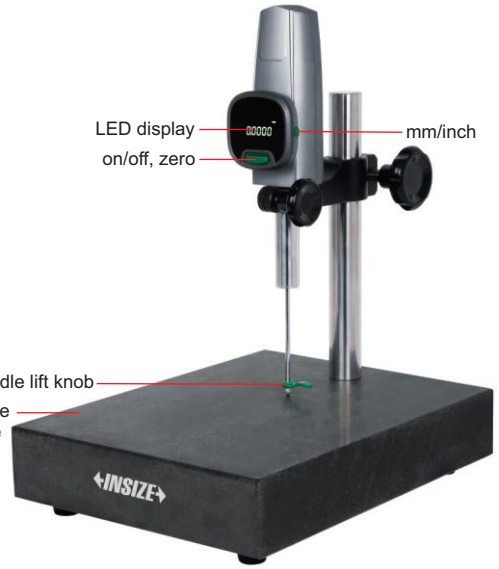
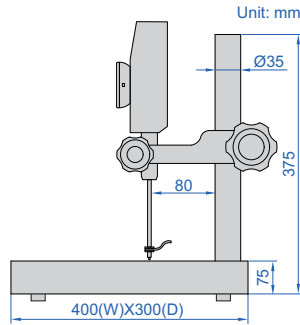

1158-100

measuring tips (included)

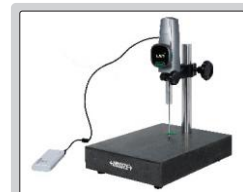
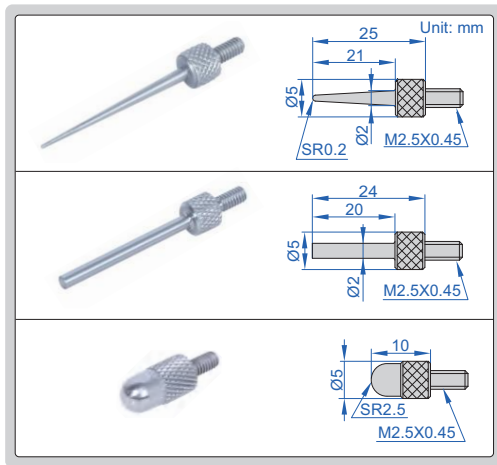

power supplied by charge pal



data transmitted to Excel without software; short press the foot switch to transmit data, long press to zero

Code	Range	Resolution	Accuracy (at 20°C)	Measuring force	Output	Power supply
1158-100	0~100mm	0.1µm/0.000005" (can switch to: 1µm/0.00005")	3µm	0.8~1.2N	USB	5V/1A (adapter or charge pal)

OPTIONAL ACCESSORY

Contact point	code 6282
Charge pal	1155-5-POB
Data output cable (including foot switch)	1155-5-FOS

STANDARD DELIVERY

Main unit	1 pc
-----------	------

DIAL INDICATOR STANDS

REFER TO PAGE 290-298 FOR DETAILS



6862-1001



6864-250T



6867-250

DIGITAL HEIGHT GAUGES

DATA
OUTPUT

4

- Non waterproof
- Resolution: 0.01mm/0.0005"
- Buttons: on/off, zero, mm/inch, ABS/INC, data hold, TOL, set
- ABS/INC is for absolute and incremental measurement
- TOL is for tolerance measurement
- Carbide tipped scriber
- Made of stainless steel (except the base)
- LR44 battery, data output
- Supplied with dial test indicator holder
- Supplied with dust cover (except 1150-1500/2000)
- Optional accessory:
 - wireless transmitter code **7315-1150** (receiver is needed) page 7,
 - data output cable (keyboard format) code **7302-SPC7** page 22,
 - clamp for protractors (code **2372-CLAMP**, for 1150-300)

scriber (included)

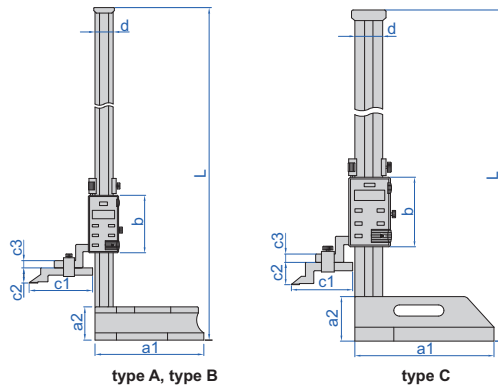
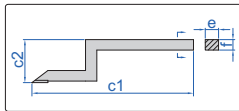

1150-1000

1150-500

1150-300

clamp for protractors (optional)
for 1150-300

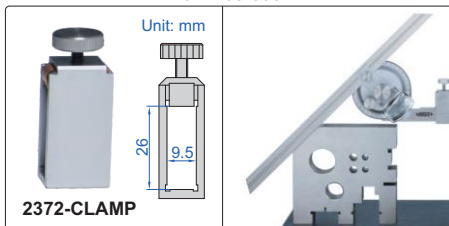

dial test indicator holder (included)

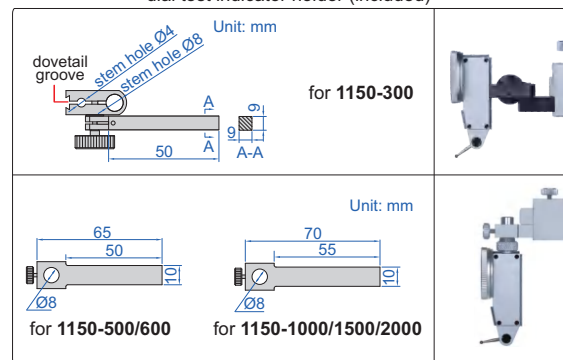

Code	Range	Type	Accuracy	L	a1	a2	b	c1	c2	c3	d	e	f
1150-300	0-300mm/0-12"	A	±0.04mm	485mm	138mm	45mm	95mm	80mm	30mm	10mm	28mm	9mm	9mm
1150-500	0-500mm/0-20"	B	±0.06mm	720mm	180mm	55mm	95mm	103mm	25mm	12mm	30mm	10mm	12mm
1150-600	0-600mm/0-24"	B	±0.06mm	820mm	180mm	55mm	95mm	103mm	25mm	12mm	30mm	10mm	12mm
1150-1000	0-1000mm/0-40"	C	±0.08mm	1275mm	250mm	80mm	125mm	110mm	39mm	15mm	50mm	10mm	15mm
1150-1500	0-1500mm/0-60"	C	±0.12mm	1790mm	280mm	80mm	125mm	110mm	39mm	15mm	50mm	10mm	15mm
1150-2000	0-2000mm/0-80"	C	±0.16mm	2290mm	280mm	80mm	125mm	110mm	39mm	15mm	50mm	10mm	15mm



DIGITAL HEIGHT GAUGES WITH DRIVING WHEEL

- Non waterproof
- Resolution: 0.01mm/0.0005"
- Buttons: on/off, zero, mm/inch, preset +, preset -, ABS/INC
- Automatic power off, move the digital unit to turn on power
- Carbide tipped scriber
- Made of stainless steel
- Battery CR2032
- Data output
- Supplied with dust cover
- With dial test indicator holder
- Optional accessory: wireless transmitter code **7315-22** (receiver is needed) page 5, bluetooth transmitter code **7214-22** page 11, data output cable code **7302-22** page 20, clamp for protractors (code **2372-CLAMP**)

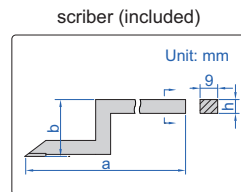
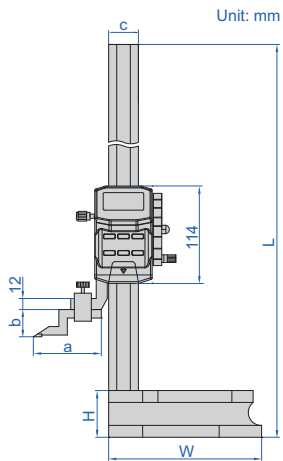

dial test indicator holder (included)

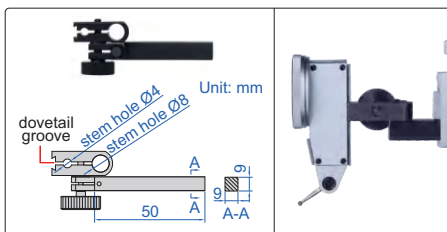

clamp for protractors (optional)

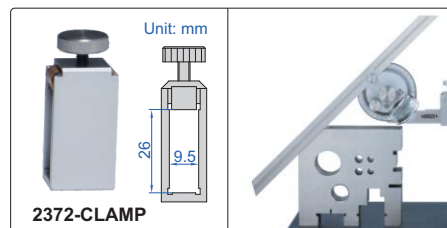

Code	Range	Accuracy	L	W	H	a	b	c	h
1156-300*	0-300mm/0-12"	±0.03mm	515mm	180mm	55mm	80mm	30mm	35mm	9mm
1156-600*	0-600mm/0-24"	±0.05mm	815mm	180mm	55mm	80mm	30mm	35mm	9mm
1156-1000*	0-1000mm/0-40"	±0.07mm	1220mm	265mm	70mm	92mm	48mm	40mm	12mm

* Supplied with manufacturer inspection certificate

DIGITAL HEIGHT GAUGES

dial test indicator holder (included)

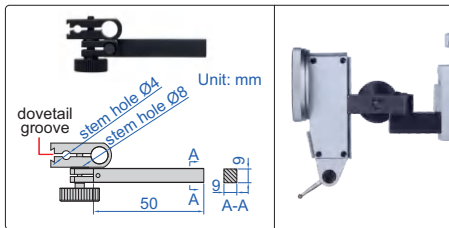

- Non waterproof
- Resolution: 0.01mm/0.0005"
- Buttons: on/off, zero, mm/inch, data hold, ABS/INC, preset
- ABS/INC is for absolute and incremental measurement
- Automatic power off, move the digital unit to turn on power
- Carbide tipped scriber
- Made of stainless steel
- Battery CR2032, data output
- With driving wheel
- With dial test indicator holder
- Supplied with dust cover
- Optional accessory: wireless transmitter code **7315-1151** (receiver is needed) page 8, data output cable code **7302-1151** page 21, clamp for protractors (code **2372-CLAMP**)



1151-300A

scriber (included)

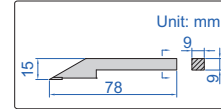

driving wheel on the back

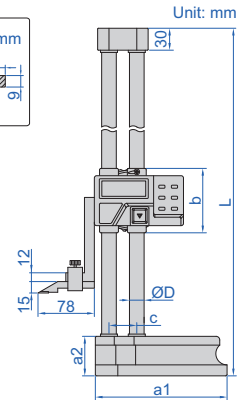

clamp for protractors (optional)

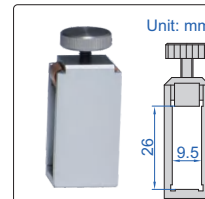

2372-CLAMP

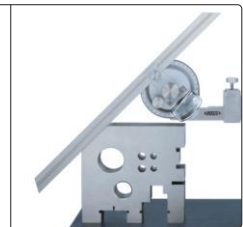

Code	Range	Accuracy	L	a1	a2	b	c	ØD
1151-300A	0-300mm/0-12"	±0.04mm	475	135	43	84	33	15
1151-450A	0-450mm/0-18"	±0.05mm	660	180	54	88	38	20
1151-600A	0-600mm/0-24"	±0.05mm	810	180	54	88	38	20

DIAL HEIGHT GAUGES

dial test indicator holder (included)

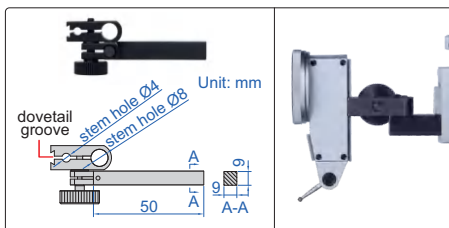

- Dial indicator graduation: 0.01mm
- One counter reads in the plus direction and another in the minus direction, so incremental measurement can be made in either direction
- Carbide tipped scriber
- Made of stainless steel (except the base)
- With driving wheel
- With dial test indicator holder
- Supplied with dust cover
- Optional accessory: clamp for protractors (code **2372-CLAMP**)

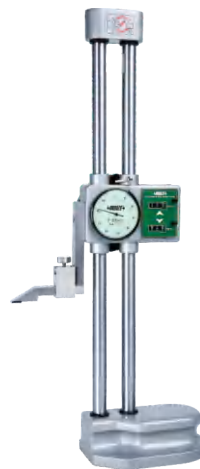

1351-300

scriber (included)

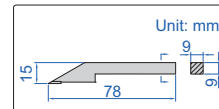

driving wheel on the back

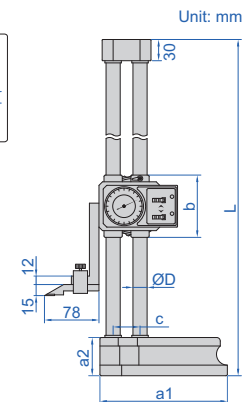

clamp for protractors (optional)

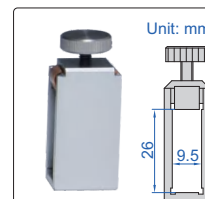

2372-CLAMP



Code	Range	Accuracy	L	a1	a2	b	c	ØD
1351-300	0-300mm	±0.04mm	475	135	43	84	33	15
1351-450	0-450mm	±0.05mm	660	180	54	88	38	20
1351-600	0-600mm	±0.05mm	810	180	54	88	38	20

DATA
OUTPUT

MINI DIGITAL HEIGHT GAUGES

- Non waterproof
- Resolution: 0.01mm/0.0005"
- Buttons: on/off, zero, mm/inch
- Automatic power off, move the digital unit to turn on power
- Carbide tipped scriber
- With fine adjustment
- Made of stainless steel
- Battery CR2032
- Optional accessory: dial test indicator holder (code **7151-CL1**)



1154-150

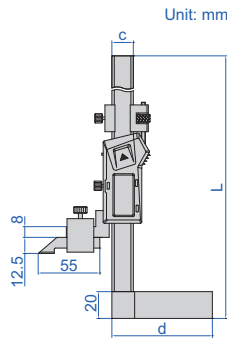

scriber (included)

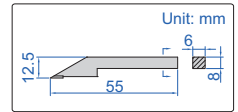

dial test indicator holder (optional)

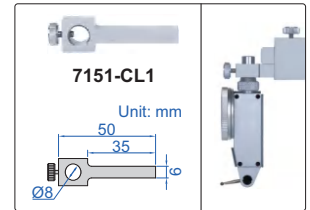

Code	Range	Accuracy	L	c	d	Data output cable (optional)
1154-150	0-150mm/0-6"	±0.03mm	280mm	16mm	75mm	7315-25 (receiver is needed) page 5, 7214-25 page 11, 7302-21 page 20
1154-200	0-200mm/0-8"	±0.03mm	340mm	20mm	90mm	7315-22 (receiver is needed) page 5, 7214-22 page 11, 7302-22 page 20

Built-in wireless (receiver code 7315-2/3/6/7/8/9 is needed)

Code	Range	Accuracy	L	c	d
1154-150WL	0-150mm/0-6"	±0.03mm	280mm	16mm	75mm

4

MINI VERNIER HEIGHT GAUGES

- Graduation: 0.02mm/0.001"
- Carbide tipped scriber
- Made of stainless steel (except the base)
- Satin chrome plated scale
- Optional accessory: dial test indicator holder (code **7151-CL1**)

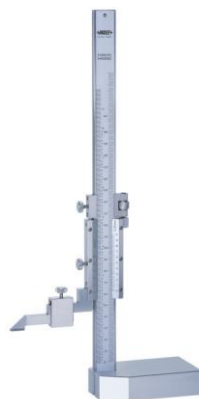

1253-200

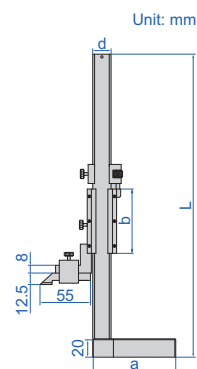

scriber (included)

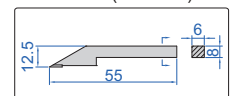

dial test indicator holder (optional)

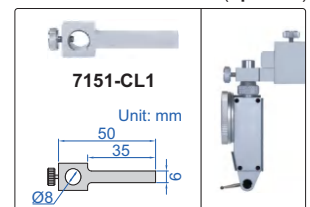

Code	Range	Accuracy	L	a	b	d
1253-150	0-150mm/0-6"	±0.03mm	265	75	57	16
1253-200	0-200mm/0-8"	±0.03mm	325	90	70	20

(mm)

VERNIER HEIGHT GAUGES

- Graduation: 0.02mm/0.001"
- Adjustable main scale to set zero
- Carbide tipped scribe
- Made of stainless steel (except the base)
- Satin chrome plated scale
- Supplied with magnifier
- With fine adjustment
- Supplied with dust cover
- Optional accessory: dial test indicator holder (code **6293-6**), clamp for protractors (code **2372-CLAMP**)

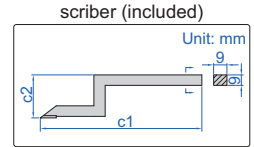
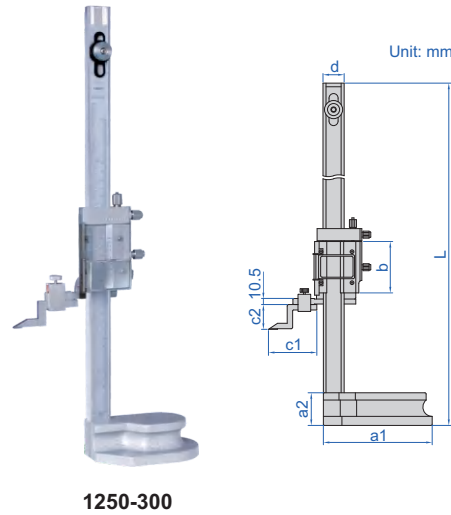

1250-300

clamp for protractors (optional)

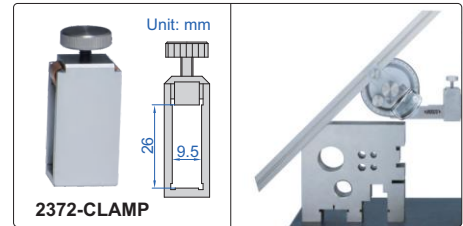

2372-CLAMP

dial test indicator holder (optional)

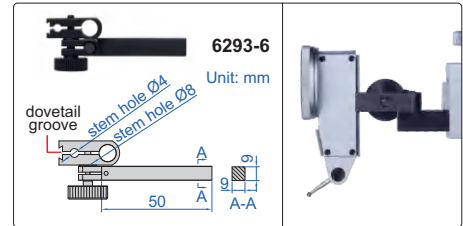

6293-6

Code	Range	Accuracy	L	a1	a2	b	c1	c2	d
1250-300	0-300mm/0-12"	±0.04mm	545	135	43	75	80	30	28
1250-450	0-450mm/0-18"	±0.05mm	720	180	54	85	80	41	35
1250-600	0-600mm/0-24"	±0.05mm	870	180	54	85	80	41	35

VERNIER HEIGHT GAUGES (BASIC TYPE)

- Graduation: 0.02mm/0.001"
- Carbide tipped scribe
- Made of stainless steel (except the base)
- Satin chrome plated scale
- With dial test indicator holder
- Supplied with dust cover

POPULAR MODEL

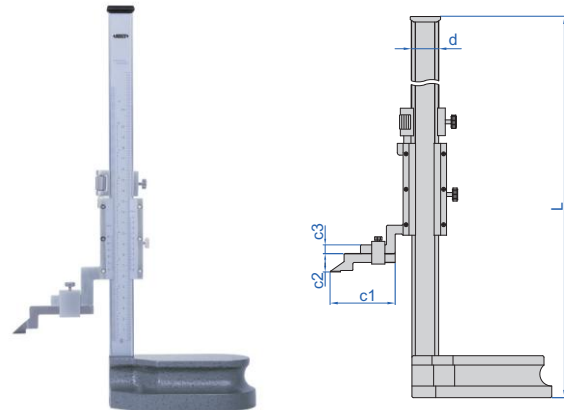

1251-200

dial test indicator holder (included)

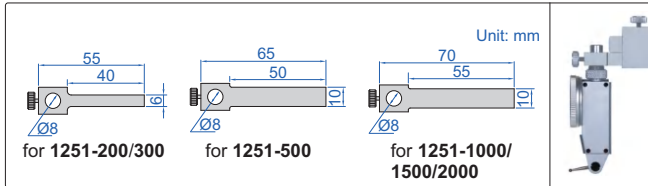

for **1251-200/300**

for **1251-500**

for **1251-1000/1500/2000**

Code	Range	Accuracy	L	c1	c2	c3	d	e	f
1251-200	0-200mm/0-8"	±0.03mm	370	76	25	10	23	6	8
1251-300	0-300mm/0-12"	±0.04mm	470	76	25	10	23	6	8
1251-500	0-500mm/0-20"	±0.05mm	720	105	25	12	30	10	12
1251-1000	0-1000mm/0-40"	±0.07mm	1275	110	39	15	50	10	15
1251-1500	0-1500mm/0-60"	±0.11mm	1790	110	39	15	50	10	15
1251-2000	0-2000mm/0-80"	±0.14mm	2290	110	39	15	50	10	15

scribe (included)

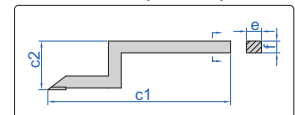

SCRIBERS FOR HEIGHT GAUGES



7150-SC3

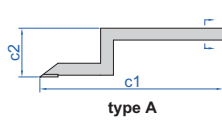

type A

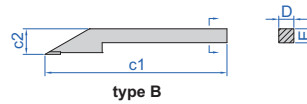

type B

- Carbide tipped

Code	For height gauges	Type	c1	c2	D	E
7150-SC2	1150-500, 1150-600	A	103mm	25mm	10mm	12mm
7150-SC3	1150-1000, 1150-1500, 1150-2000	A	110mm	39mm	10mm	15mm
7150-SC4	1351-300, 1351-450, 1351-600, 1151-300A, 1151-450A, 1151-600A	B	78mm	15mm	9mm	9mm
7150-SC6	1250-300, 1156-300, 1156-600, 1150-300	A	80mm	30mm	9mm	9mm
7150-SC7	1250-450, 1250-600	A	80mm	41mm	9mm	9mm
7150-SC9	1253-150, 1253-200, 1154-150	B	55mm	12.5mm	6mm	8mm
7150-SC10	1156-1000	A	92mm	48mm	9mm	12mm

REFER TO PAGE 360 FOR DETAILS

CALIPER/HEIGHT GAUGE CHECKERS

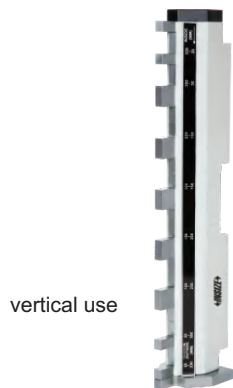

vertical use



horizontal use

6884-300



Carbon Fiber Comparison Gauges
Page 112-113



Comparison Gauges
Page 114-115



Internal/External Measuring Gauges
Page 116-123



**Internal And External Diameter
Comparison Instruments**
Page 124-125



Outside Diameter Measuring Stands
Page 126

CARBON FIBER RODS, LIGHT WEIGHT, NOT EASY TO DEFORM, NO TEMPERATURE EXPAND, SUITABLE FOR THIN-WALL WORKPIECES AND LARGE-SIZE WORKPIECES

CARBON FIBER COMPARISON GAUGES

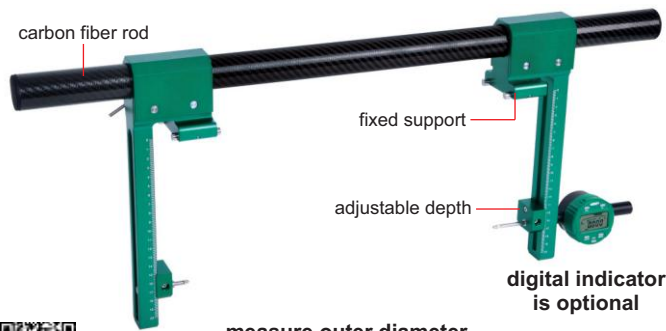

measure outer diameter



measure inside diameter, minimum diameter is 220mm

2931-D1000B



- Measure outer diameter, inside diameter, holes distance and cylindrical workpiece length
- Carbon fiber rods, light weight, not easy to deform, no temperature expand
- Optional accessory: cylinder gauge blocks (code 4001), digital indicators (code 2138-25SP/2139-25SP/2103-25SP/2104-25SP)

Code	Maximum measuring range (L)	Measuring depth (H)	Repeatability	Weight
2931-D1000A	1000mm	0-100mm	5μm	2.0kg
2931-D1000B	1000mm	0-200mm	10μm	2.3kg
2931-D1000C	1000mm	0-300mm	25μm	2.6kg
2931-D1500A	1500mm	0-100mm	8μm	2.3kg
2931-D1500B	1500mm	0-200mm	15μm	2.6kg
2931-D1500C	1500mm	0-300mm	30μm	2.9kg
2931-D2000A	2000mm	0-100mm	10μm	2.6kg
2931-D2000B	2000mm	0-200mm	20μm	2.9kg
2931-D2000C	2000mm	0-300mm	35μm	3.2kg
2931-D2500A	2500mm	0-100mm	12μm	2.9kg
2931-D2500B	2500mm	0-200mm	25μm	3.2kg
2931-D2500C	2500mm	0-300mm	50μm	3.5kg
2931-D3000A	3000mm	0-100mm	14μm	3.2kg
2931-D3000B	3000mm	0-200mm	30μm	3.5kg
2931-D3000C	3000mm	0-300mm	60μm	3.8kg
2931-D4000A	4000mm	0-100mm	16μm	3.8kg
2931-D4000B	4000mm	0-200mm	35μm	4.1kg
2931-D4000C	4000mm	0-300mm	65μm	4.4kg
2931-D5000A	5000mm	0-100mm	25μm	4.4kg
2931-D5000B	5000mm	0-200mm	40μm	4.7kg
2931-D5000C	5000mm	0-300mm	70μm	5.0kg
2931-D6000A	6000mm	0-100mm	28μm	8.4kg
2931-D6000B	6000mm	0-200mm	50μm	8.8kg
2931-D6000C	6000mm	0-300mm	80μm	9.2kg
2931-D7000A	7000mm	0-100mm	30μm	9.2kg
2931-D7000B	7000mm	0-200mm	55μm	9.6kg
2931-D7000C	7000mm	0-300mm	100μm	10kg
2931-D8000A	8000mm	0-100mm	32μm	10kg
2931-D8000B	8000mm	0-200mm	60μm	10.4kg
2931-D8000C	8000mm	0-300mm	110μm	10.8kg
2931-D9000A	9000mm	0-100mm	35μm	10.7kg
2931-D9000B	9000mm	0-200mm	70μm	11.1kg
2931-D9000C	9000mm	0-300mm	120μm	11.5kg

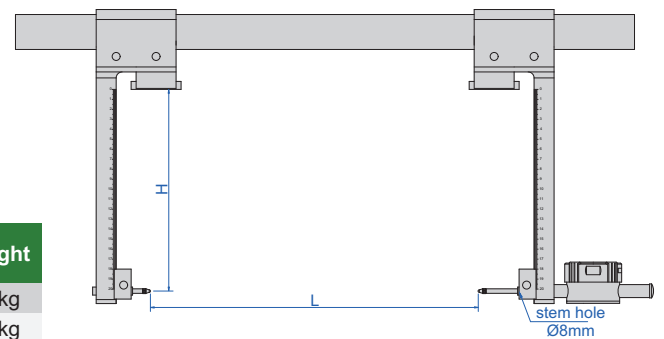

application

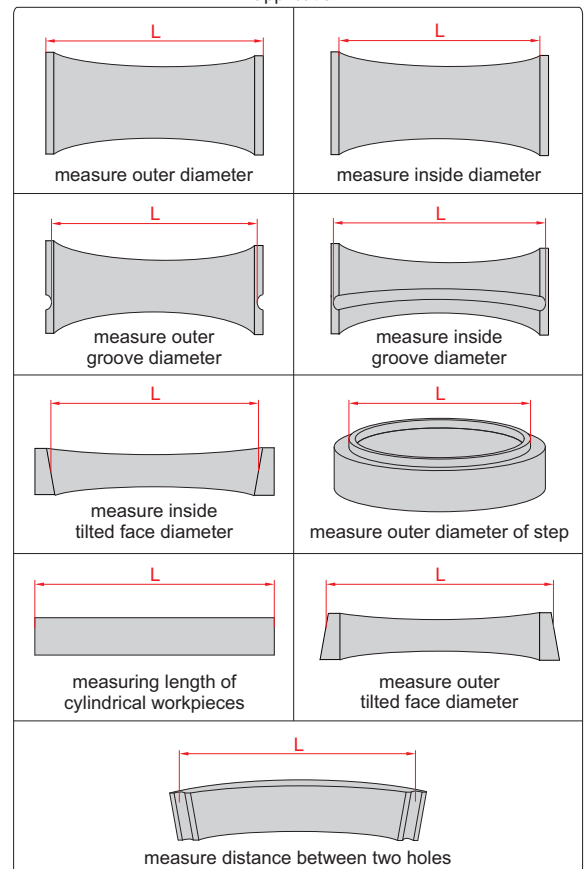

To be continued

Continued from previous page

5



Calibration bracket (optional)

Code	Remark
2931-J□□□□	can be customized according to carbon fiber comparison gauges, including 2 measuring brackets and multiple support brackets to support gauge blocks

Calibration jaw (optional, supplied in pair)

Code	Remark
2931-F	made of carbide

application

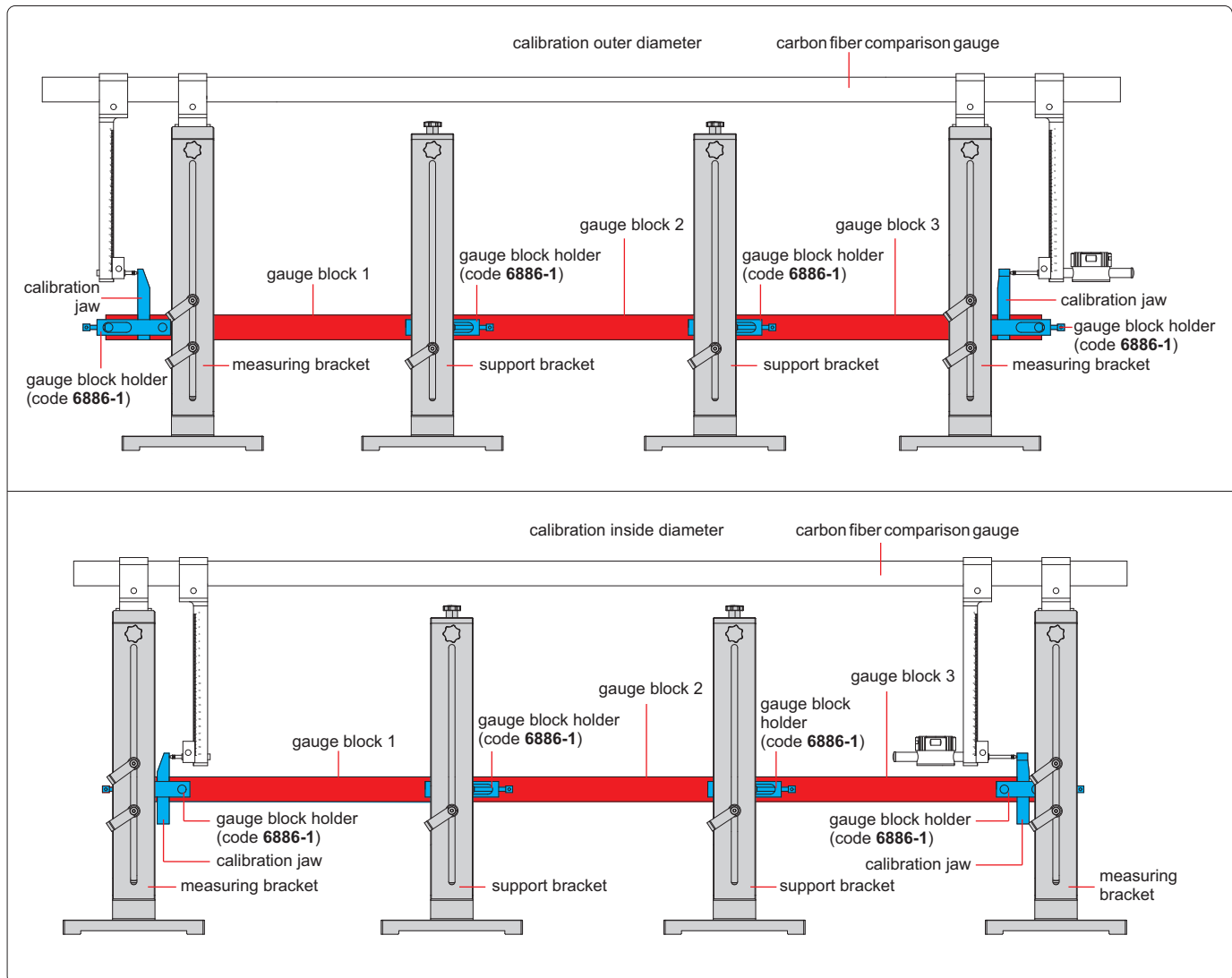



CUSTOMIZABLE MEASURING
JAWS AND POINTS

COMPARISON GAUGES

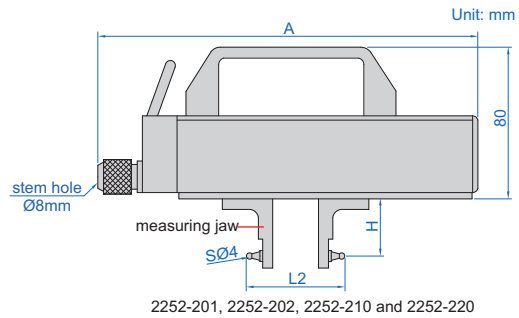
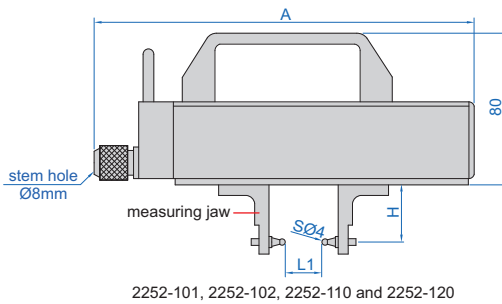
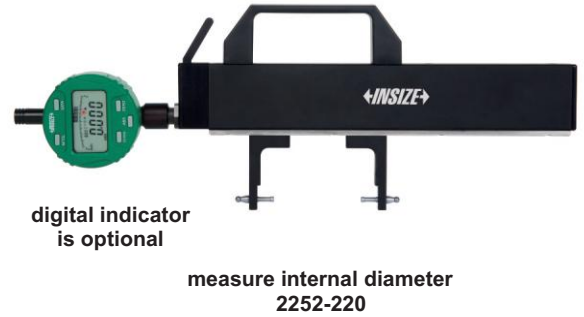

- Measure external diameter, internal diameter and over-pin diameter of gears
- Total range of movable point: 8mm, effective range of movable point: ± 2 mm
- Optional accessory: digital indicator (code **2138-10F**), gauge block grade 1 (**4101-B** series)

Measure external diameter

Code	Range of external diameter (L1)	Accuracy*	Repeatability	A	H
2252-101	25-90mm/1-3.54"	$\pm 5\mu\text{m}$	1 μm	195mm	40mm
2252-102	25-140mm/1-5.51"	$\pm 5\mu\text{m}$	1 μm	245mm	40mm
2252-110	25-90mm/1-3.54"	$\pm 5\mu\text{m}$	2 μm	195mm	70mm
2252-120	25-140mm/1-5.51"	$\pm 5\mu\text{m}$	2 μm	245mm	70mm

Measure internal diameter

Code	Range of external diameter (L2)	Accuracy*	Repeatability	A	H
2252-201	42-105mm/1.65-4.13"	$\pm 5\mu\text{m}$	1 μm	195mm	40mm
2252-202	42-160mm/1.65-6.30"	$\pm 5\mu\text{m}$	1 μm	245mm	40mm
2252-210	42-105mm/1.65-4.13"	$\pm 5\mu\text{m}$	2 μm	195mm	70mm
2252-220	42-160mm/1.65-6.30"	$\pm 5\mu\text{m}$	2 μm	245mm	70mm

*Within ± 2 mm effective range

external diameter measurement application

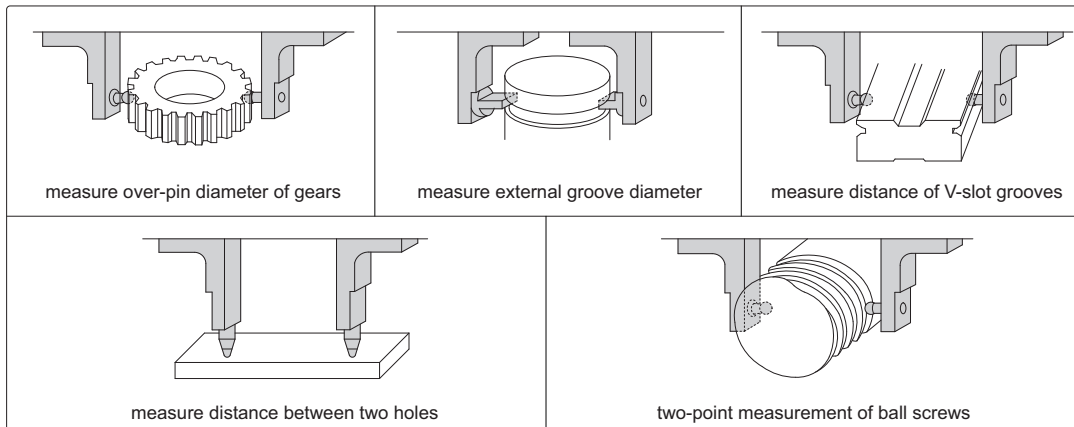

To be continued

Continued from previous page

5

internal diameter measurement application

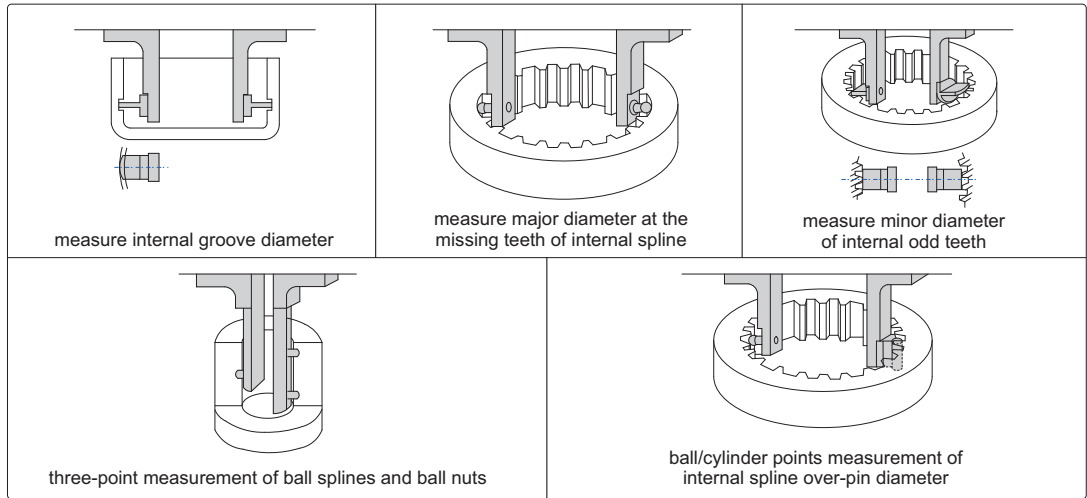

customizable points

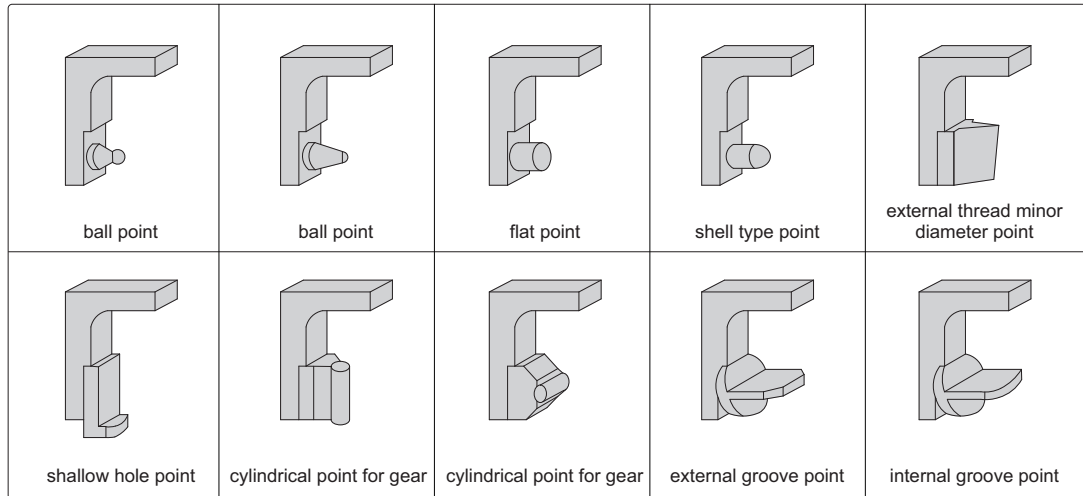

customizable measuring jaws

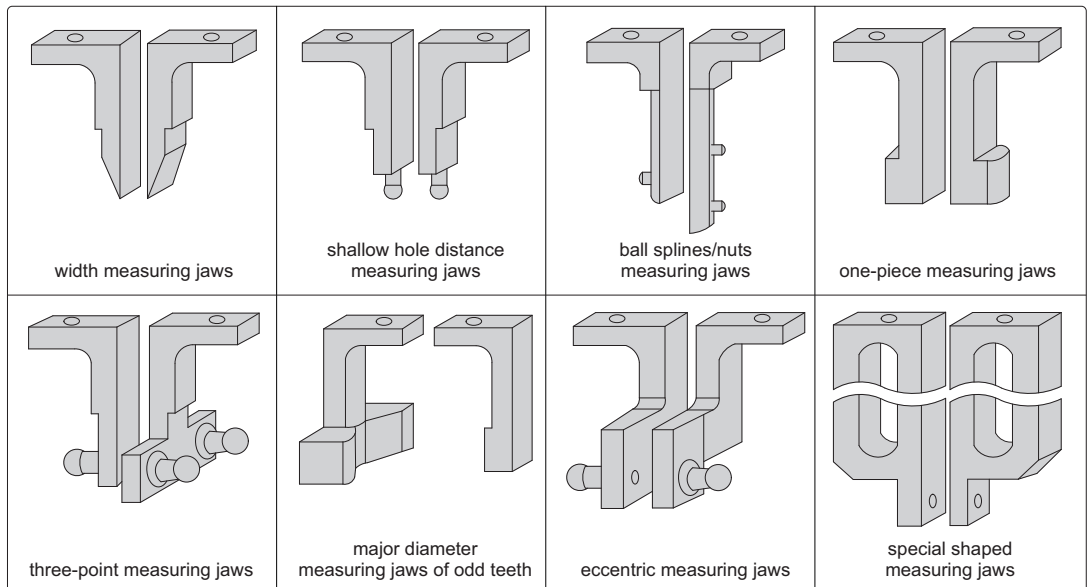



DATA
OUTPUT

DIGITAL INTERNAL MEASURING GAUGES

- Measure internal dimensions
- Resolution: 0.001mm/0.00005"
- Accuracy: 5µm
- Repeatability: 1µm
- Movable point stroke: 5mm/0.02"
- Point height is adjustable, h=2-25mm
- CR2032 battery, automatic power off (time is adjustable)
- Data output



2932-451

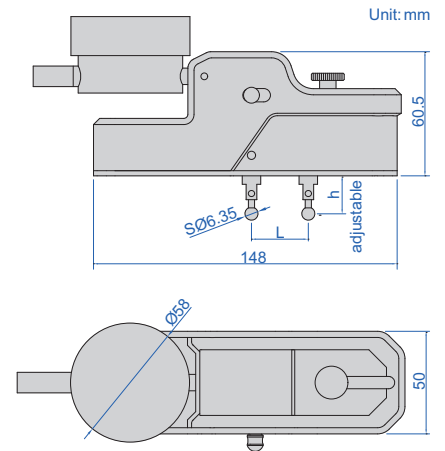

Code	Measuring range (L) *	Indicator	Data output cable (optional)
2932-45	24-50mm/0.95-2"	Button function: on/off, inch/mm, zero, data preset, change measuring direction, absolute/incremental measurement	7315-50M (receiver is needed) page 6, 7214-50M page 12, 7302-40M page 21
2932-451	24-50mm/0.95-2"	With transmission button and signal light Reading in digital and analog Display can be rotated by 320° Button function: on/off, inch/mm, zero, data preset, change measuring direction, absolute/incremental measurement, max./min./TIR measurement, tolerance Go and No-Go display	7315-51 (receiver is needed) page 6, 7214-51 page 12, 7302-40M page 21

* The measuring range will change according to different measuring points

Disk points (optional, supplied in pair)

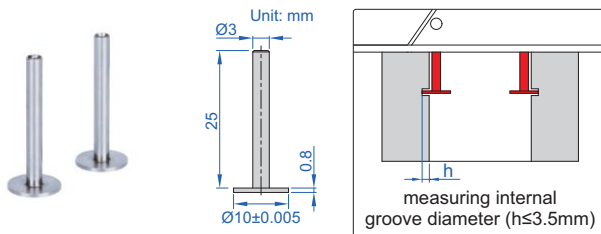

Code	Measuring range	Material
2932-S101	30-55mm/1.2-2.2"	stainless steel

Conical points (optional, supplied in pair)

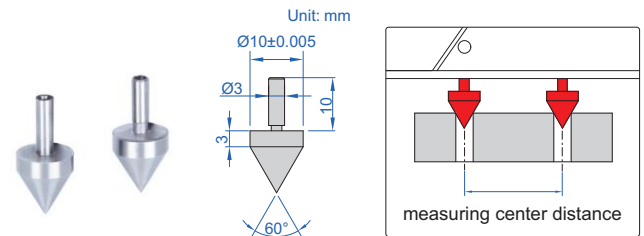

Code	Measuring range	Material
2932-S102	20-45mm/0.8-1.8"	stainless steel

Spherical points (optional, supplied in pair)

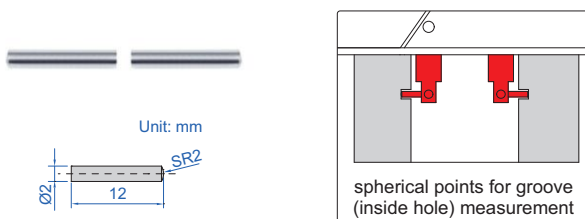

Code	Measuring range	Material
2932-S103	30-60mm/1.2-2.4"	stainless steel

Spherical blade points (optional, supplied in pair)

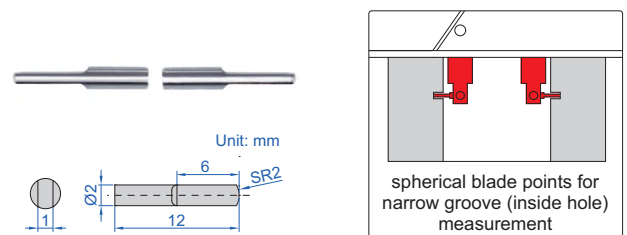

Code	Measuring range	Material
2932-S104	30-60mm/1.2-2.4"	stainless steel

To be continued

Continued from previous page

Ball points (optional, supplied in pair)



1527-T104

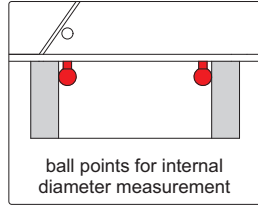
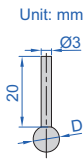

Point sleeve (optional, supplied in pair)

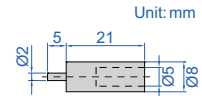

Code

1526-T101

installation

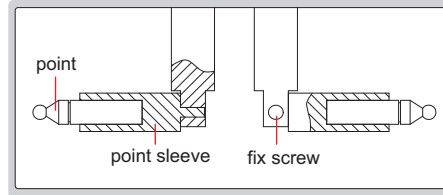

5

Code	Diameter (D)	Accuracy of diameter	Material
1527-T102	1/8" (Ø3.175mm)	±0.005mm	stainless steel
1527-T103	3/16" (Ø4.7625mm)	±0.005mm	stainless steel
1527-T104	1/4" (Ø6.35mm)	±0.005mm	stainless steel
1527-T105	3/8" (Ø9.525mm)	±0.005mm	stainless steel
1527-T106	1/2" (Ø12.7mm)	±0.005mm	stainless steel

Multifunctional points (optional, supplied in pair)



7392-T1



7392-T2



7392-T3



7392-T4



7392-T5



7392-T6



7392-T7



7392-T8



7392-T9

Measuring range **

80-105mm/3.2-4.2"

** After installing points and point sleeve

Code	Type
7392-T1 *	flat
7392-T2 *	spherical
7392-T3 *	spline
7392-T4 *	disk
7392-T5 *	blade
7392-T6 *	knife-edge
7392-T7 *	point
7392-T8 *	knife-edge
7392-T9 *	point

* It is necessary to use point sleeve (code 1526-T101) for these points

Screw thread points (optional, supplied in pair)



7321-T16

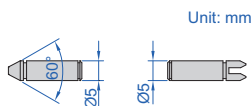

Measuring range **

80-105mm/3.2-4.2"

** After installing points and point sleeve

Internal thread (60° thread angle)

Code	Pitch
7321-T11 *	0.4-0.5mm/64-48TPI
7321-T12 *	0.6-0.9mm/44-28TPI
7321-T13 *	1-1.75mm/24-14TPI
7321-T14 *	2-3mm/13-9TPI
7321-T15 *	3.5-5mm/8-5TPI
7321-T16 *	5.5-7mm/4.5-3.5TPI
7321-T1S *	6 pairs/set, including all above points

* It is necessary to use point sleeve (code 1526-T101) for these points

Ball points (optional, supplied in pair)



7391-T5

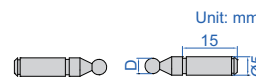

Measuring range **

80-105mm/3.2-4.2"

** After installing points and point sleeve

Code	Ball dia. (D)
7391-T2 *	SØ1.5mm
7391-T3 *	SØ2.0mm
7391-T4 *	SØ2.5mm
7391-T5 *	SØ3.0mm
7391-T6 *	SØ3.5mm
7391-T7 *	SØ4.0mm
7391-T8 *	SØ4.5mm
7391-T9 *	SØ5.0mm
7391-T10 *	SØ6.0mm

* It is necessary to use point sleeve (code 1526-T101) for these points



DATA
OUTPUT

DIGITAL EXTERNAL MEASURING GAUGES

- Measure external dimensions
- Resolution: 0.001mm/0.00005"
- Accuracy: 5µm
- Repeatability: 1µm
- Movable point stroke: 5mm/0.02"
- Point height is adjustable, h=2-25mm
- CR2032 battery, automatic power off (time is adjustable)
- Data output



2934-401

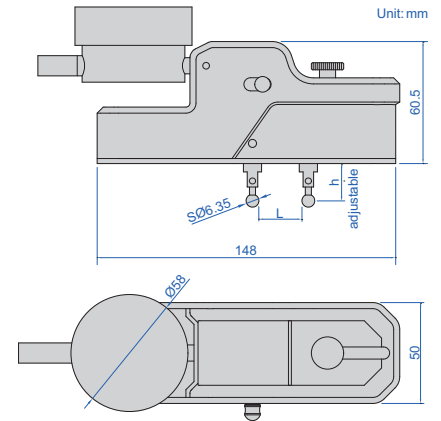

Code	Measuring range (L) *	Indicator	Data output cable (optional)
2934-40	13-38mm/0.51-1.5"	Button function: on/off, inch/mm, zero, data preset, change measuring direction, absolute/incremental measurement	7315-50M (receiver is needed) page 6, 7214-50M page 12, 7302-40M page 21
2934-401	13-38mm/0.51-1.5"	With transmission button and signal light Reading in digital and analog Display can be rotated by 320° Button function: on/off, inch/mm, zero, data preset, change measuring direction, absolute/incremental measurement, max./min./TIR measurement, tolerance Go and No-Go display	7315-51 (receiver is needed) page 6, 7214-51 page 12, 7302-40M page 21

* The measuring range will change according to different measuring points

Disk points (optional, supplied in pair)

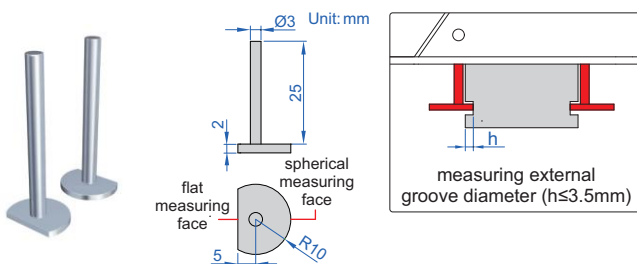

Code	Measuring range	Material
2934-S101	10-35mm/0.4-1.4"	stainless steel

Conical points (optional, supplied in pair)

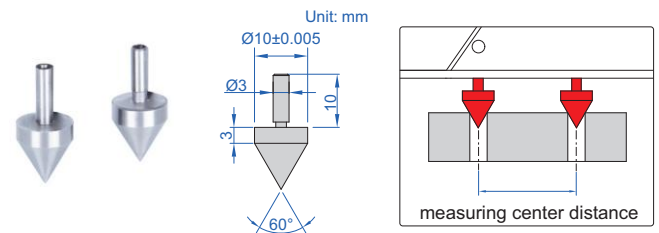

Code	Measuring range	Material
2932-S102	20-45mm/0.8-1.8"	stainless steel

Flat shoulder points (optional, supplied in pair)

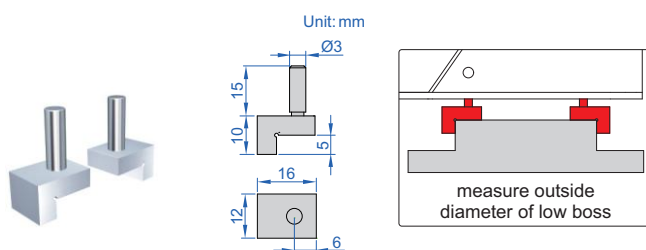

Code	Measuring range	Material
2934-S102	30-55mm/1.2-2.2"	stainless steel

Ball points (optional, supplied in pair)

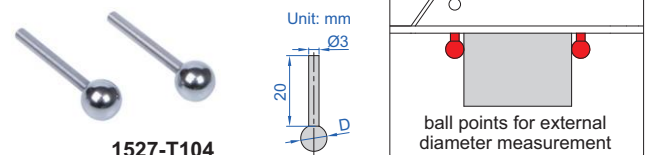

Code	Diameter (D)	Accuracy of diameter	Material
1527-T102	1/8" (Ø3.175mm)	±0.005mm	stainless steel
1527-T103	3/16" (Ø4.7625mm)	±0.005mm	stainless steel
1527-T104	1/4" (Ø6.35mm)	±0.005mm	stainless steel
1527-T105	3/8" (Ø9.525mm)	±0.005mm	stainless steel
1527-T106	1/2" (Ø12.7mm)	±0.005mm	stainless steel

LARGE RANGE DIGITAL INTERNAL MEASURING GAUGES

DATA OUTPUT



2933-331



5

- Measure internal dimensions
- Resolution: 0.001mm/0.00005"
- Accuracy: 5µm
- Repeatability: 1µm
- Movable point stroke: 5mm/0.02"
- Point height is adjustable, h=2-25mm
- CR2032 battery, automatic power off (time is adjustable)
- Data output

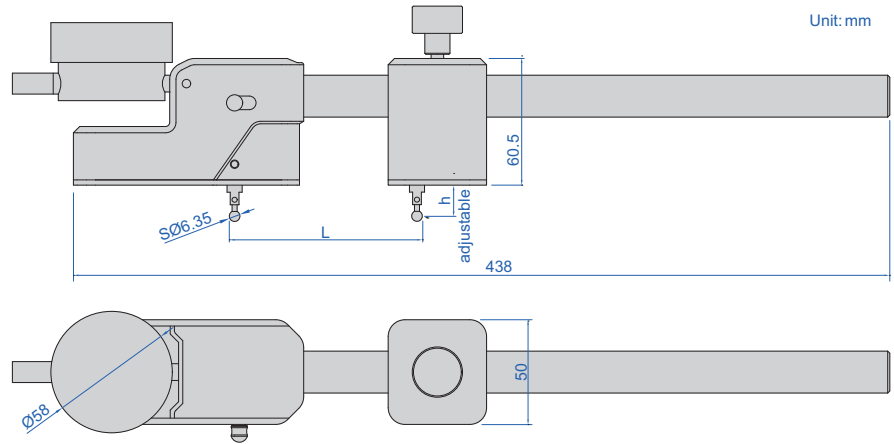

Code	Measuring range (L) *	Indicator	Data output cable (optional)
2933-330	48-330mm/1.89-13"	Button function: on/off, inch/mm, zero, data preset, change measuring direction, absolute/incremental measurement	7315-50M (receiver is needed) page 6, 7214-50M page 12, 7302-40M page 21
2933-331	48-330mm/1.89-13"	With transmission button and signal light Reading in digital and analog Display can be rotated by 320° Button function: on/off, inch/mm, zero, data preset, change measuring direction, absolute/incremental measurement, max./min./TIR measurement, tolerance Go and No-Go display	7315-51 (receiver is needed) page 6, 7214-51 page 12, 7302-40M page 21

*The measuring range will change according to different measuring points

To be continued

Continued from previous page

Disk points (optional, supplied in pair)

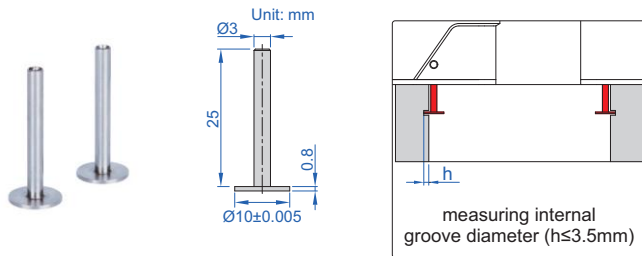

Code	Measuring range	Material
2932-S101	52-330mm/2.05-13"	stainless steel

Conical points (optional, supplied in pair)

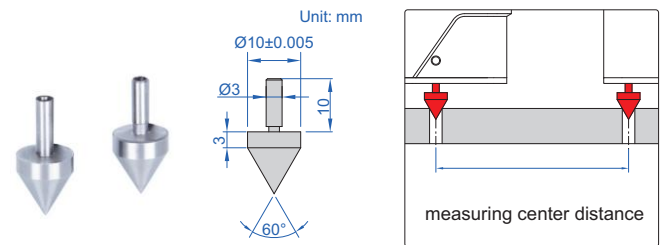

Code	Measuring range	Material
2932-S102	42-320mm/1.65-12.6"	stainless steel

Spherical points (optional, supplied in pair)

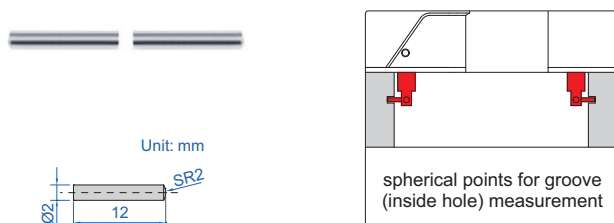

Code	Measuring range	Material
2932-S103	55-330mm/2.16-13"	stainless steel

Spherical blade points (optional, supplied in pair)

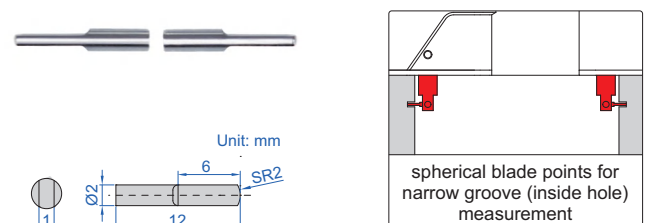

Code	Measuring range	Material
2932-S104	55-330mm/2.16-13"	stainless steel

Ball points (optional, supplied in pair)

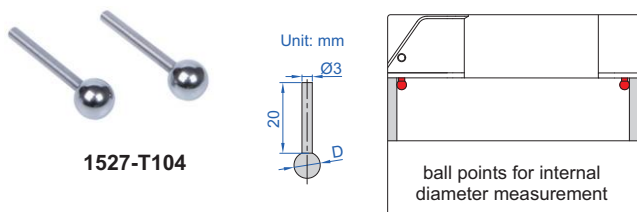

Code	Diameter (D)	Accuracy of diameter	Material
1527-T102	1/8" (Ø3.175mm)	±0.005mm	stainless steel
1527-T103	3/16" (Ø4.7625mm)	±0.005mm	stainless steel
1527-T104	1/4" (Ø6.35mm)	±0.005mm	stainless steel
1527-T105	3/8" (Ø9.525mm)	±0.005mm	stainless steel
1527-T106	1/2" (Ø12.7mm)	±0.005mm	stainless steel

Point sleeve (optional, supplied in pair)



Code
1526-T101

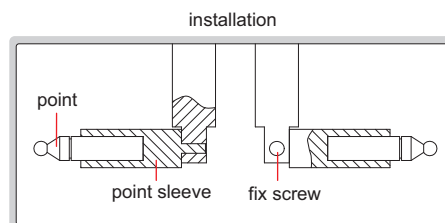

To be continued

Continued from previous page

Multifunctional points (optional, supplied in pair)

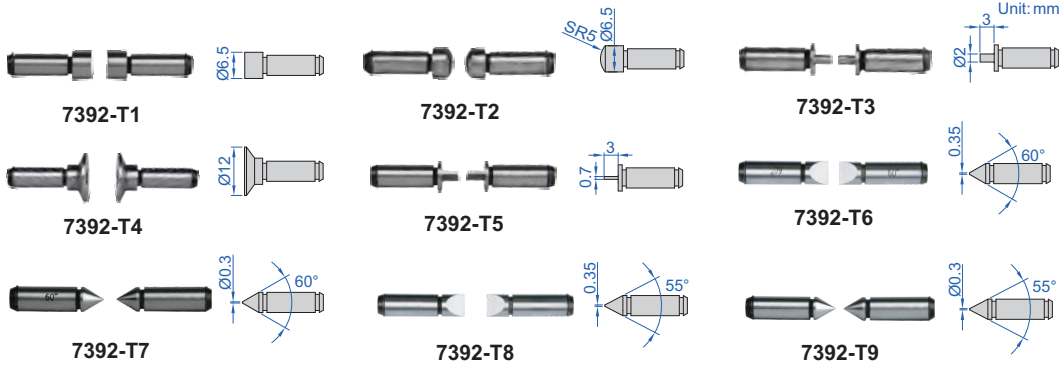

Measuring range **
100-370mm/3.94-14.5"

** After installing points and point sleeve

Code	Type
7392-T1 *	flat
7392-T2 *	spherical
7392-T3 *	spline
7392-T4 *	disk
7392-T5 *	blade
7392-T6 *	knife-edge
7392-T7 *	point
7392-T8 *	knife-edge
7392-T9 *	point

* It is necessary to use point sleeve (code 1526-T101) for these points

Screw thread points (optional, supplied in pair)

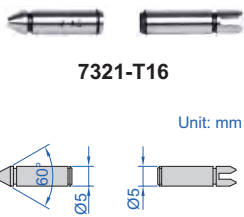

7321-T16

Internal thread (60° thread angle)

Code	Pitch
7321-T11 *	0.4-0.5mm/64-48TPI
7321-T12 *	0.6-0.9mm/44-28TPI
7321-T13 *	1-1.75mm/24-14TPI
7321-T14 *	2-3mm/13-9TPI
7321-T15 *	3.5-5mm/8-5TPI
7321-T16 *	5.5-7mm/4.5-3.5TPI
7321-T1S *	6 pairs/set, including all above points

Measuring range **
100-370mm/3.94-14.5"

** After installing points and point sleeve

* It is necessary to use point sleeve (code 1526-T101) for these points

Ball points (optional, supplied in pair)

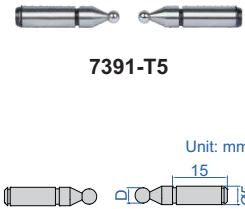

7391-T5

Code	Ball dia. (D)
7391-T2 *	SØ1.5mm
7391-T3 *	SØ2.0mm
7391-T4 *	SØ2.5mm
7391-T5 *	SØ3.0mm
7391-T6 *	SØ3.5mm
7391-T7 *	SØ4.0mm
7391-T8 *	SØ4.5mm
7391-T9 *	SØ5.0mm
7391-T10 *	SØ6.0mm

Measuring range **
100-370mm/3.94-14.5"

** After installing points and point sleeve

* It is necessary to use point sleeve (code 1526-T101) for these points

LARGE RANGE DIGITAL EXTERNAL MEASURING GAUGES

DATA OUTPUT



2935-321

- Measure external dimensions
- Resolution: 0.001mm/0.00005"
- Accuracy: 5µm
- Repeatability: 1µm
- Movable point stroke: 5mm/0.02"
- Point height is adjustable, h=2-25mm
- CR2032 battery, automatic power off (time is adjustable)
- Data output



To be continued

Continued from previous page

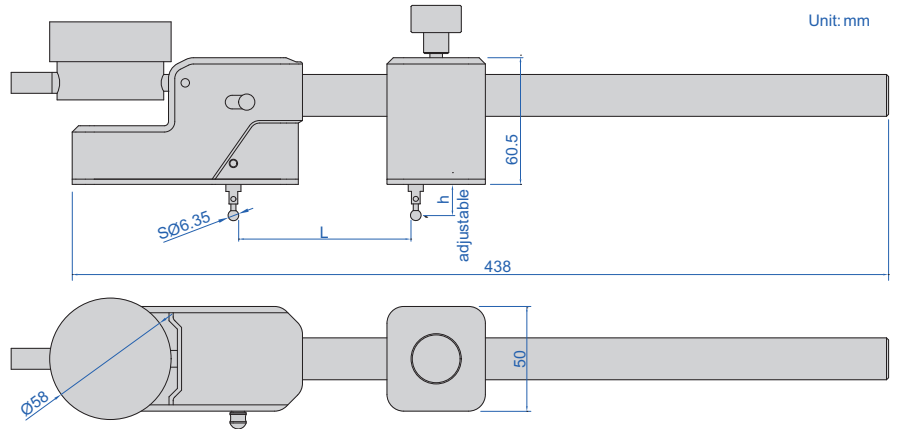

Code	Measuring range (L) *	Indicator	Data output cable (optional)
2935-320	35-320mm/1.4-12.6"	Button function: on/off, inch/mm, zero, data preset, change measuring direction, absolute/incremental measurement	7315-50M (receiver is needed) page 6, 7214-50M page 12, 7302-40M page 21
2935-321	35-320mm/1.4-12.6"	With transmission button and signal light Reading in digital and analog Display can be rotated by 320° Button function: on/off, inch/mm, zero, data preset, change measuring direction, absolute/incremental measurement, max./min./TIR measurement, tolerance Go and No-Go display	7315-51 (receiver is needed) page 6, 7214-51 page 12, 7302-40M page 21

* The measuring range will change according to different measuring points

Disk points (optional, supplied in pair)

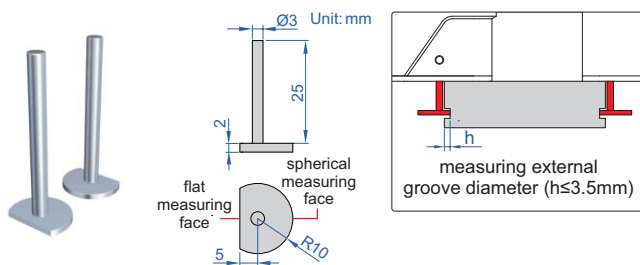

Code	Measuring range	Material
2934-S101	32-320mm/1.26-12.6"	stainless steel

Conical points (optional, supplied in pair)

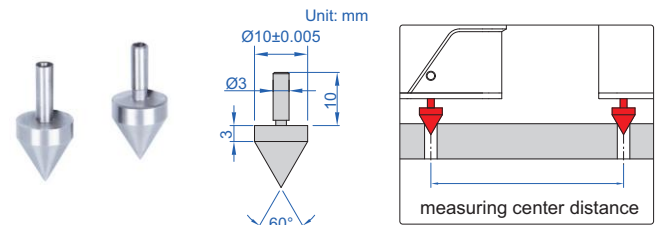

Code	Measuring range	Material
2932-S102	42-320mm/1.65-12.6"	stainless steel

Flat shoulder points (optional, supplied in pair)

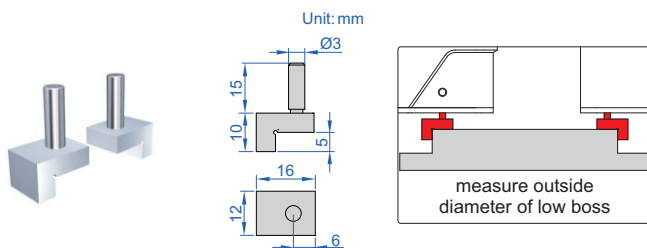

Code	Measuring range	Material
2934-S102	52-320mm/2.05-12.6"	stainless steel

Ball points (optional, supplied in pair)

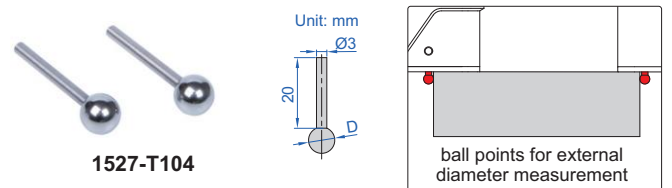

Code	Diameter (D)	Accuracy of diameter	Material
1527-T102	1/8" (Ø3.175mm)	±0.005mm	stainless steel
1527-T103	3/16" (Ø4.7625mm)	±0.005mm	stainless steel
1527-T104	1/4" (Ø6.35mm)	±0.005mm	stainless steel
1527-T105	3/8" (Ø9.525mm)	±0.005mm	stainless steel
1527-T106	1/2" (Ø12.7mm)	±0.005mm	stainless steel

To be continued

Continued from previous page

Spherical/flat points (optional, supplied in pair)

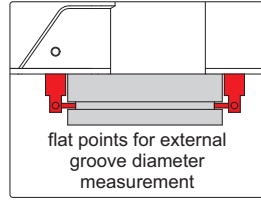
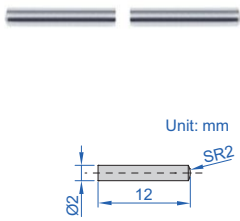

Code	Measuring range	Material
2932-S103	30-320mm/1.2-12.6"	stainless steel

Point sleeve (optional, supplied in pair)

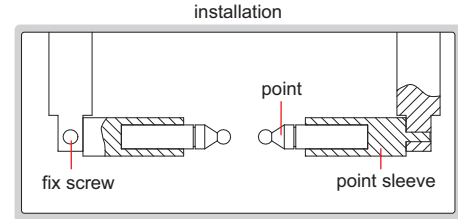

Code
1526-T101

Multifunctional points (optional, supplied in pair)

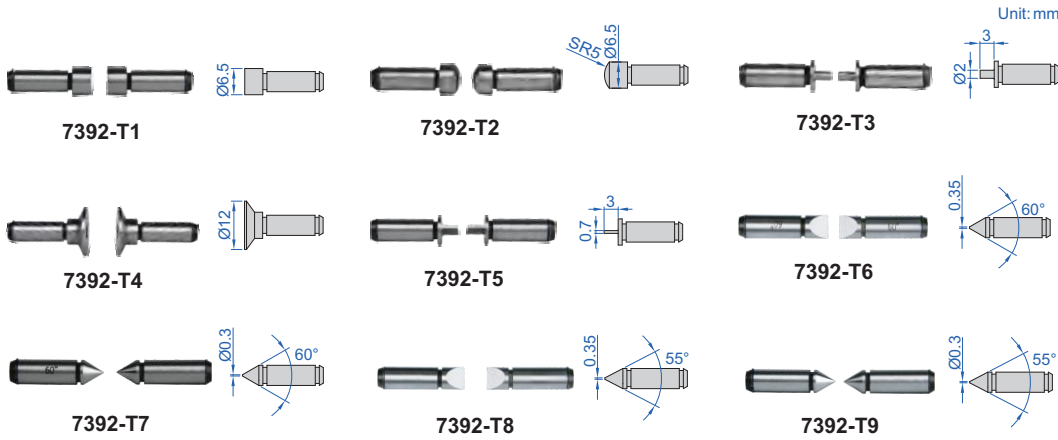

Code	Type
7392-T1 *	flat
7392-T2 *	spherical
7392-T3 *	spline
7392-T4 *	disk
7392-T5 *	blade
7392-T6 *	knife-edge
7392-T7 *	point
7392-T8 *	knife-edge
7392-T9 *	point

Measuring range **
0-300mm/0-11.8"

** After installing points and point sleeve

* It is necessary to use point sleeve (code 1526-T101) for these points

Screw thread points (optional, supplied in pair)

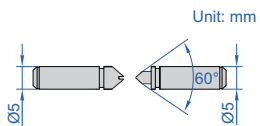

Measuring range **
0-300mm/0-11.8"

** After installing points and point sleeve

External thread (60° thread angle)

Code	Pitch
7381-T11 *	0.4-0.5mm/64-48TPI
7381-T12 *	0.6-0.9mm/44-28TPI
7381-T13 *	1-1.75mm/24-14TPI
7381-T14 *	2-3mm/13-9TPI
7381-T15 *	3.5-5mm/8-5TPI
7381-T16 *	5.5-7mm/4.5-3.5TPI
7381-TS *	6 pairs/set, including all above points

* It is necessary to use point sleeve (code 1526-T101) for these points

Ball points (optional, supplied in pair)

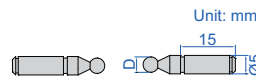

Measuring range **
0-300mm/0-11.8"

** After installing points and point sleeve

Code	Ball dia. (D)
7391-T2 *	SØ1.5mm
7391-T3 *	SØ2.0mm
7391-T4 *	SØ2.5mm
7391-T5 *	SØ3.0mm
7391-T6 *	SØ3.5mm
7391-T7 *	SØ4.0mm
7391-T8 *	SØ4.5mm
7391-T9 *	SØ5.0mm
7391-T10 *	SØ6.0mm

* It is necessary to use point sleeve (code 1526-T101) for these points



INTERNAL AND EXTERNAL DIAMETER COMPARISON INSTRUMENT

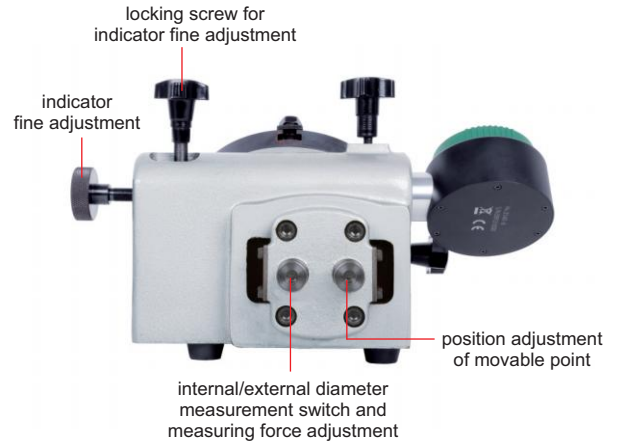

- Measure internal/external diameter, variation and taper
- Total range of movable point: 2mm, effective range of movable point: $\pm 0.1\text{mm}$
- Groove probes and disc probes are included
- Optional accessory: $\text{\O}28\text{mm}/\text{\O}8\text{mm}$ bush (code 6843-B8), cross table, 0.001mm digital/dial indicators, high precision digital indicators (code 2140-6, 2140-6WL)

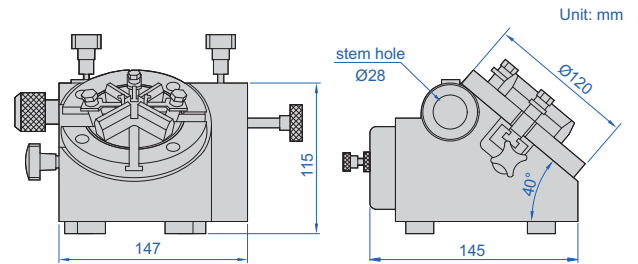

Unit: mm

Code	Applicable holding stem	Range of internal diameter	Range of external diameter	Accuracy	Repeatability
6844-100	$\text{\O}28\text{mm}$	20-100mm/0.8-3.9"	15-80mm/0.6-3.1"	$\pm 0.001\text{mm}$	0.001mm

cross table (working with groove probes)

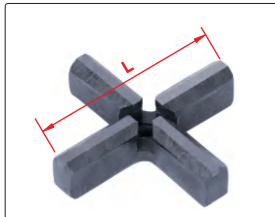

disc probes (included)



groove probes to measure small internal diameter and internal groove diameter

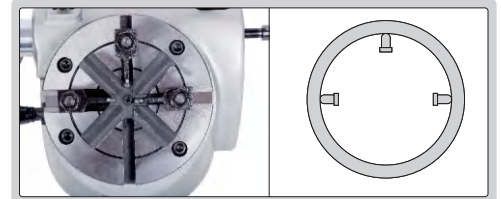

Cross table

Code	L	Remark
6844-T40	40mm	included
6844-T80	80mm	optional
6844-T100	100mm	optional

groove probe (included)



disc probes to measure large internal diameter

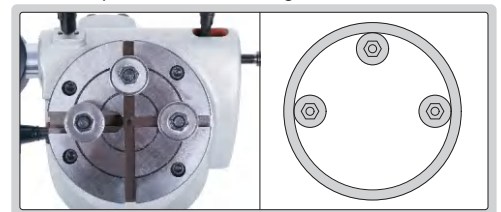

$\text{\O}28\text{mm}/\text{\O}8\text{mm}$ bush (optional)



Code
6843-B8

application



disc probes to measure external diameter

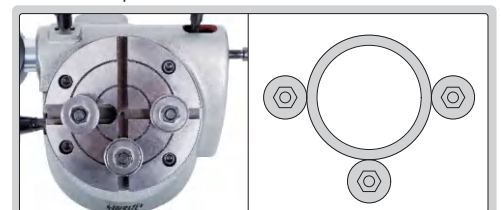

INTERNAL AND EXTERNAL DIAMETER COMPARISON INSTRUMENT



5

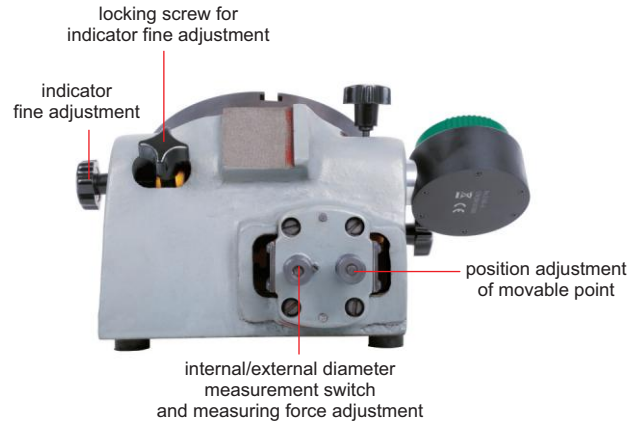
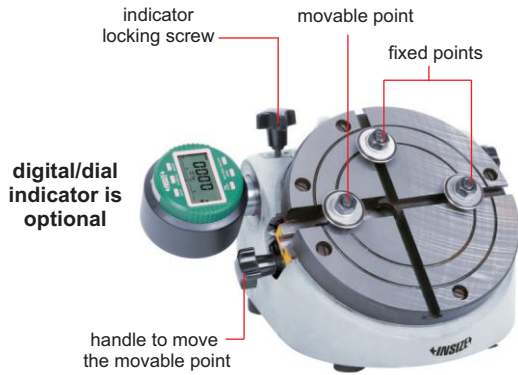

- Measure internal/external diameter, variation and taper
- Total range of movable point: 2mm, effective range of movable point: ±0.1mm
- Optional accessory: Ø28mm/Ø8mm bush (code 6843-B8), 0.001mm digital/dial indicators, high precision digital indicators (code 2140-6, 2140-6WL)

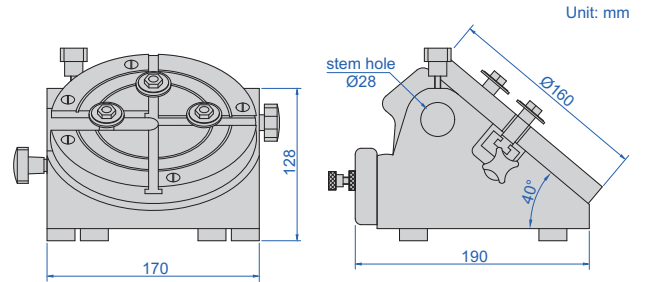

internal diameter measurement

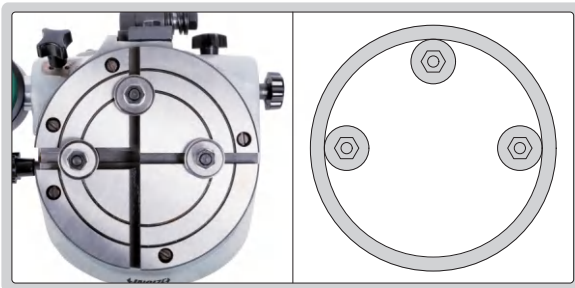

external diameter measurement

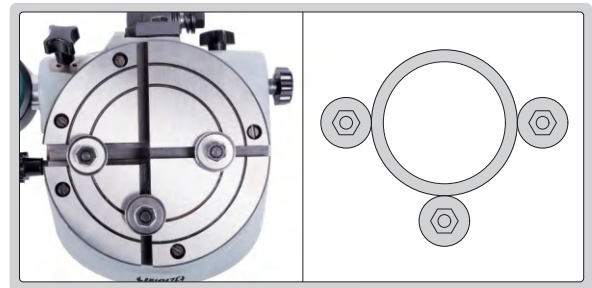

Code	Applicable holding stem	Range of internal diameter	Range of external diameter	Accuracy	Repeatability
6843-140	Ø28mm	50-140mm/2-5.5"	30-120mm/1.2-4.7"	±0.001mm	0.001mm

Ø28mm/Ø8mm bush (optional)



Code

6843-B8

application





OUTSIDE DIAMETER MEASURING STAND



6847-50

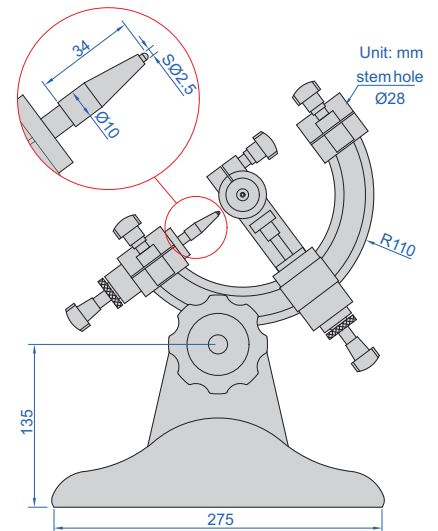

- To measure diameter and roundness of cylinders and steel balls
- Supplied with measuring base (code **6847-A100**)
- Optional accessory: Ø28mm/Ø8mm bush (code **6843-B8**), 0.001mm digital/dial indicators, high precision digital indicators (code **2140-6**, **2140-6WL**), gauge blocks (**4101** series, for zero setting of cylinders), custom plug gauges (for zero setting of cylinders), ceramic standard balls (**4190** series, for zero setting of steel balls)

Code	Range of outside diameter	Accuracy	Repeatability
6847-50	1.5-50mm/0.06-2"	±0.001mm	0.0005mm

Measuring base

Code	Diameter	Remark
6847-A10	10mm	optional
6847-A20	20mm	optional
6847-A30	30mm	optional
6847-A40	40mm	optional
6847-A50	50mm	optional
6847-A60	60mm	optional
6847-A70	70mm	optional
6847-A75	75mm	optional
6847-A80	80mm	optional
6847-A90	90mm	optional
6847-A100	100mm	included

Ø28mm/Ø8mm bush (optional)



Code
6843-B8

application





Digital Micrometers/Snap Gauges
Page 129-132



Digital Micrometers
Page 133-136



Outside Micrometers
Page 137-143

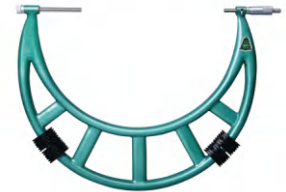

Large Outside Micrometers
Page 143-147



Limit Micrometers
Page 148



Indicating Micrometers
Page 148-150



Micrometers With Dial Indicator
Page 151-153



Groove Micrometers
Page 153



3-Wires
Page 154



Screw Thread Micrometers
Page 155-159



Gear Tooth Micrometers
Page 159-161



Point Micrometers
Page 162-163



Gear Root Diameter Micrometers
Page 164



Blade Micrometers
Page 165-167



Crimp Height Micrometers
Page 168



Spline Micrometers
Page 168-170



Tube Micrometers
Page 171-173



Disk Brake Micrometers
Page 174



Sheet Metal Micrometers
Page 174-175



Interchangeable Anvil Micrometers
Page 175-176



Large Anvil Micrometers
Page 176



V-Anvil Micrometers
Page 177



Universal Micrometers
Page 178



Caliper Type Micrometers
Page 179



Jaw Type Micrometers
Page 180



Disk Micrometers
Page 181-184



Sheet Metal Micrometers
Page 185



Micrometers For Hot Plate
Page 185



Hub Micrometers
Page 185



Wire Micrometers
Page 186



Can Seam Micrometers
Page 186



Optical Parallels
Page 186



Parallelism Inspect Devices For Outside Micrometers
Page 186



Measuring Tools Dynamometers
Page 187



Micrometer Measuring Force Detectors
Page 188



Micrometer Inspection Gauge Block Sets
Page 188



Micrometer Stands
Page 188-189



Micrometer Setting Standards
Page 190



Micrometer Lapping Machines
Page 191-192



Micrometer Heads
Page 192-196

HIGH PRECISION DIGITAL MICROMETERS/SNAP GAUGES

ONE TURN OF SLEEVE MAKES 10MM SPINDLE FEED, PRESS THE FORK, THE SPINDLE RETRACTS 3MM

MEASUREMENT ACCURACY IS NOT AFFECTED BY THE USE OF SLEEVE

IP65 WATERPROOF

DATA OUTPUT

ABSOLUTE ENCODER, THE ORIGINAL DATA REMAINS AFTER POWER OFF

ATTENTION: RECHARGEABLE BATTERY, FOR 24 HOURS CONTINUOUS WORKING

NON-ROTATING SPINDLE

INSPECTION CERTIFICATE



6

alarm when over tolerance

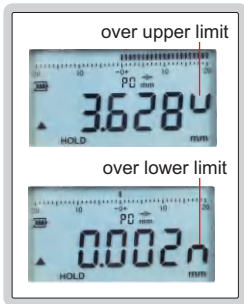

3359-25

wireless receiver 2134-R1, 2134-R2 (optional)



- Absolute encoder, the original data remains after power off
- Resolution: 0.0001mm/0.00001"
- One turn of sleeve makes 10mm spindle feed
- Measurement accuracy is not affected by the use of sleeve
- Press the fork, the spindle retracts 3mm
- Carbide measuring faces
- Measuring force 5-10N
- Button function: data output, tolerance, data preset, data hold, measuring direction change, max./min./TIR, power off time, on/off, zero, mm/inch
- Power: rechargeable battery, for 24 hours continuous working

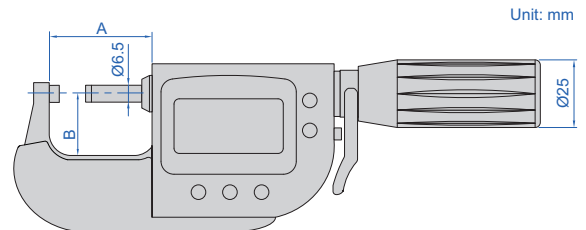

Unit: mm

With data interface

Optional accessory:

wireless transmitter code 7315-3350 (receiver is needed) page 7

data output cable (keyboard format) code 7302-3350 page 21

Code	Range	Accuracy	Repeatability	Measuring faces		A	B
				flatness	parallelism		
3359-25*	0-25mm/0-1"	±0.5µm	0.3µm	0.3µm	0.6µm	38mm	24mm

Built-in wireless

Optional accessory:

wireless receiver (keyboard format, connect up to 15 digital indicators), code 2134-R1

wireless receiver (serial port format, connect up to 15 digital indicators), code 2134-R2

Code	Range	Accuracy	Repeatability	Measuring faces		A	B
				flatness	parallelism		
3359-25WL*	0-25mm/0-1"	±0.5µm	0.3µm	0.3µm	0.6µm	38mm	24mm

*Supplied with manufacturer inspection certificate

DIGITAL MICROMETERS/SNAP GAUGES (BASIC TYPE)

ONE TURN OF SLEEVE MAKES 10MM SPINDLE FEED, PRESS THE FORK, THE SPINDLE RETRACTS 3MM

MEASUREMENT ACCURACY IS NOT AFFECTED BY THE USE OF SLEEVE

IP65 WATERPROOF

DATA OUTPUT

ABSOLUTE ENCODER, THE ORIGINAL DATA REMAINS AFTER POWER OFF

ATTENTION: RECHARGEABLE BATTERY, FOR 24 HOURS CONTINUOUS WORKING

NON-ROTATING SPINDLE

INSPECTION CERTIFICATE

POPULAR MODEL



3358-25

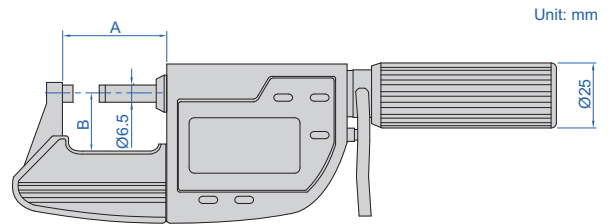

- Absolute encoder, the original data remains after power off
- Resolution: 0.001mm/0.00005"
- One turn of sleeve makes 10mm spindle feed
- Measurement accuracy is not affected by the use of sleeve
- Press the fork, the spindle retracts 3mm
- Carbide measuring faces
- Measuring force 5-10N
- Button function: data output, tolerance, data preset, data hold, measuring direction change, max./min./TIR, power off time, on/off, zero, mm/inch
- Supplied with gauge blocks for zero setting (except 0-25mm/0-1")
- Power: rechargeable battery, for 24 hours continuous working

alarm when over tolerance

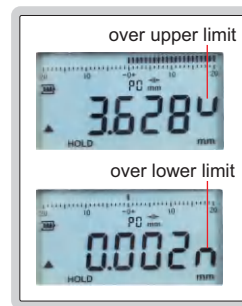

wireless receiver 2134-R1, 2134-R2 (optional)



With data interface

Optional accessory:

wireless transmitter code **7315-3350** (receiver is needed) page 7
data output cable (keyboard format) code **7302-3350** page 21

Code	Range	Accuracy	Repeatability	Measuring faces		A	B
				flatness	parallelism		
3358-25 *	0-25mm/0-1"	2µm	1µm	0.5µm	1.2µm	38mm	24mm
3358-50 *	25-50mm/1-2"	2µm	1µm	0.5µm	1.2µm	64mm	32.5mm
3358-75 *	50-75mm/2-3"	3µm	1µm	0.5µm	1.8µm	89mm	46mm
3358-100 *	75-100mm/3-4"	3µm	1µm	0.5µm	1.8µm	114mm	60mm

Built-in wireless

Optional accessory:

wireless receiver (keyboard format, connect up to 15 digital indicators), code **2134-R1**

wireless receiver (serial port format, connect up to 15 digital indicators), code **2134-R2**

Code	Range	Accuracy	Repeatability	Measuring faces		A	B
				flatness	parallelism		
3358-25WL *	0-25mm/0-1"	2µm	1µm	0.5µm	1.2µm	38mm	24mm
3358-50WL *	25-50mm/1-2"	2µm	1µm	0.5µm	1.2µm	64mm	32.5mm
3358-75WL *	50-75mm/2-3"	3µm	1µm	0.5µm	1.8µm	89mm	46mm
3358-100WL *	75-100mm/3-4"	3µm	1µm	0.5µm	1.8µm	114mm	60mm

* Supplied with manufacturer inspection certificate

DIGITAL MICROMETERS/SNAP GAUGES

ONE TURN OF SLEEVE MAKES 5MM SPINDLE FEED, PRESS THE FORK, THE SPINDLE RETRACTS 3MM

MEASUREMENT ACCURACY IS NOT AFFECTED BY THE USE OF SLEEVE

IP65 WATERPROOF

DATA OUTPUT

ATTENTION: RECHARGEABLE BATTERY, FOR 24 HOURS CONTINUOUS WORKING

NON-ROTATING SPINDLE

ABSOLUTE ENCODER, THE ORIGINAL DATA REMAINS AFTER POWER OFF

INSPECTION CERTIFICATE



3350-25

- Absolute encoder, the original data remains after power off
- Adjustable resolution: 0.0002mm/0.00001"
 - 0.001mm/0.00005"
 - 0.01mm/0.0005"
- One turn of sleeve makes 5mm spindle feed
- Measurement accuracy is not affected by the use of sleeve
- Press the fork, the spindle retracts 3mm
- Linear ball bearings for ten million times use
- Carbide measuring faces
- Measuring force 5-10N
 - Customizable measuring force range 2-12N
 - Attention: small measuring force will reduce the dustproof and waterproof level
- Button function: data output, tolerance, data preset, data hold, measuring direction change, max./min./TIR, power off time, on/off, zero, mm/inch, adjust resolution
- Supplied with gauge blocks for zero setting (except 0-25mm/0-1")
- Power: rechargeable battery, for 24 hours continuous working

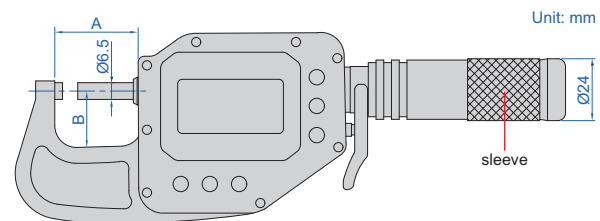

With data interface

Optional accessory:

wireless transmitter code **7315-3350** (receiver is needed) page 7

data output cable (keyboard format) code **7302-3350** page 21

Code	Range	Accuracy	Repeatability	Measuring faces		A	B
				flatness	parallelism		
3350-25*	0-25mm/0-1"	1.4µm	0.6µm	0.5µm	1µm	38mm	24mm
3350-50*	25-50mm/1-2"	1.6µm	1µm	0.5µm	1µm	63mm	28mm
3350-75*	50-75mm/2-3"	1.8µm	1µm	0.5µm	1µm	88mm	45mm
3350-100*	75-100mm/3-3.95"	2µm	1µm	0.5µm	1µm	113mm	57mm

alarm when over tolerance

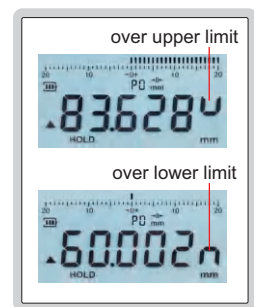

Built-in wireless

Optional accessory:

wireless receiver (keyboard format, connect up to 15 digital indicators), code **2134-R1**

wireless receiver (serial port format, connect up to 15 digital indicators), code **2134-R2**

Code	Range	Accuracy	Repeatability	Measuring faces		A	B
				flatness	parallelism		
3350-25WL*	0-25mm/0-1"	1.4µm	0.6µm	0.5µm	1µm	38mm	24mm
3350-50WL*	25-50mm/1-2"	1.6µm	1µm	0.5µm	1µm	63mm	28mm
3350-75WL*	50-75mm/2-3"	1.8µm	1µm	0.5µm	1µm	88mm	45mm
3350-100WL*	75-100mm/3-3.95"	2µm	1µm	0.5µm	1µm	113mm	57mm

wireless receiver 2134-R1, 2134-R2 (optional)



*Supplied with manufacturer inspection certificate

IP65
WATERPROOF

ABSOLUTE ENCODER, THE ORIGINAL
DATA REMAINS AFTER POWER OFF



ONE TURN OF SLEEVE MAKES 5MM SPINDLE FEED,
PRESS THE FORK, THE SPINDLE RETRACTS 3MM

ATTENTION: RECHARGEABLE BATTERY,
FOR 24 HOURS CONTINUOUS WORKING

NON-ROTATING
SPINDLE

DATA
OUTPUT

MEASUREMENT ACCURACY IS NOT
AFFECTED BY THE USE OF SLEEVE



DIGITAL MICROMETERS/SNAP GAUGES



3351-275

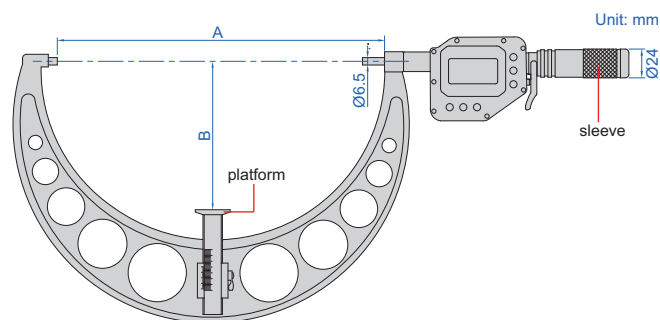

- Absolute encoder, the original data remains after power off
- Adjustable resolution: 0.0002mm/0.00001" (when the reading exceeds 100mm, the resolution is automatically switched to 0.001mm) 0.001mm/0.00005" 0.01mm/0.0005"
- One turn of sleeve makes 5mm spindle feed
- Measurement accuracy is not affected by the use of sleeve
- Press the fork, the spindle retracts 3mm
- Linear ball bearings for ten million times use
- Carbide measuring faces
- Measuring force 5-10N
Customizable measuring force range 2-12N
Attention: small measuring force will reduce the dustproof and waterproof level
- Button function: data output, tolerance, data preset, data hold, measuring direction change, max./min./TIR, power off time, on/off, zero, mm/inch, adjust resolution
- Supplied with gauge blocks for zero setting
- Power: rechargeable battery, for 24 hours continuous working

6

gauge blocks for zero setting (included)



With data interface

Optional accessory:
wireless transmitter code **7315-3350** (receiver is needed) page 7
data output cable (keyboard format) code **7302-3350** page 21

Code	Range	Accuracy	Repeatability	Measuring faces		A	B
				flatness	parallelism		
3351-125 *	100-125mm/4-5"	3µm	1µm	0.5µm	2µm	128mm	62.5mm
3351-150 *	125-150mm/5-6"	3µm	1µm	0.5µm	2µm	153mm	75mm
3351-175 *	150-175mm/6-7"	4µm	1µm	0.5µm	2.5µm	178mm	87.5mm
3351-200 *	175-200mm/7-8"	4µm	1µm	0.5µm	2.5µm	203mm	100mm
3351-225 *	200-225mm/8-9"	5µm	1µm	0.5µm	3µm	228mm	112.5mm
3351-250 *	225-250mm/9-10"	5µm	1µm	0.5µm	3µm	253mm	125mm
3351-275 *	250-275mm/10-11"	6µm	1µm	0.5µm	3.5µm	278mm	137.5mm
3351-300 *	275-300mm/11-12"	6µm	1µm	0.5µm	3.5µm	303mm	150mm

Built-in wireless

Optional accessory:
wireless receiver (keyboard format, connect up to 15 digital indicators), code **2134-R1**
wireless receiver (serial port format, connect up to 15 digital indicators), code **2134-R2**

Code	Range	Accuracy	Repeatability	Measuring faces		A	B
				flatness	parallelism		
3351-125WL *	100-125mm/4-5"	3µm	1µm	0.5µm	2µm	128mm	62.5mm
3351-150WL *	125-150mm/5-6"	3µm	1µm	0.5µm	2µm	153mm	75mm
3351-175WL *	150-175mm/6-7"	4µm	1µm	0.5µm	2.5µm	178mm	87.5mm
3351-200WL *	175-200mm/7-8"	4µm	1µm	0.5µm	2.5µm	203mm	100mm
3351-225WL *	200-225mm/8-9"	5µm	1µm	0.5µm	3µm	228mm	112.5mm
3351-250WL *	225-250mm/9-10"	5µm	1µm	0.5µm	3µm	253mm	125mm
3351-275WL *	250-275mm/10-11"	6µm	1µm	0.5µm	3.5µm	278mm	137.5mm
3351-300WL *	275-300mm/11-12"	6µm	1µm	0.5µm	3.5µm	303mm	150mm

alarm when
over tolerance

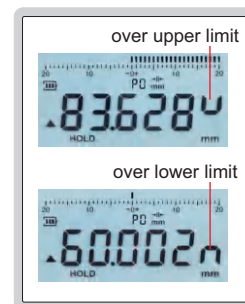

wireless receiver
2134-R1, 2134-R2 (optional)



* Supplied with manufacturer inspection certificate

WATERPROOF DIGITAL OUTSIDE MICROMETERS (WITH DATA OUTPUT)

POPULAR MODEL

DATA OUTPUT IP65 WATERPROOF

INSPECTION CERTIFICATE

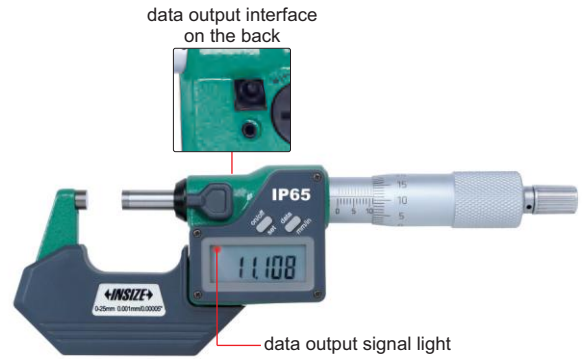
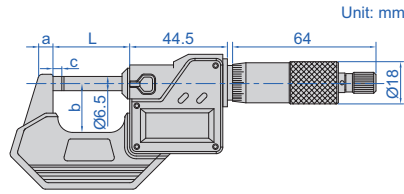

3101-25A

- IP65 dust/waterproof
- Button function: on/off, set, mm/inch, data transmit
- Automatic power off
- Carbide measuring faces
- Supplied with spherical anvil
- Setting standards are included (except 0-25mm/0-1")
- Optional accessory:
 - wireless transmitter code **7315-31** (receiver is needed) page 6,
 - bluetooth transmitter code **7214-31** page 12,
 - data output cable code **7302-31** page 20

Metric/Inch type (ratchet stop)

(mm)

Code	Range	Resolution	Accuracy	L	a	b	c
3101-25A*	0-25mm/0-1"	0.001mm/0.00005"	±2µm	34.5	6	25	3
3101-50A*	25-50mm/1-2"	0.001mm/0.00005"	±2µm	59.5	8	32	3
3101-75A*	50-75mm/2-3"	0.001mm/0.00005"	±3µm	84.5	8	44.5	3
3101-100A*	75-100mm/3-4"	0.001mm/0.00005"	±3µm	109.5	8	57	3
3101-125A	100-125mm/4-5"	0.001mm/0.00005"	±3µm	135	10	70	3
3101-150A	125-150mm/5-6"	0.001mm/0.00005"	±3µm	160.5	10	82	3
3101-175A	150-175mm/6-7"	0.001mm/0.00005"	±4µm	186	12	94.5	5.5
3101-200A	175-200mm/7-8"	0.001mm/0.00005"	±4µm	211.5	12	107	5.5
3101-225A	200-225mm/8-9"	0.001mm/0.00005"	±4µm	236	23	129.5	5.5
3101-250A	225-250mm/9-10"	0.001mm/0.00005"	±4µm	261.5	23	142.5	5.5
3101-275A	250-275mm/10-11"	0.001mm/0.0001"	±5µm	287	23	155	5.5
3101-300A	275-300mm/11-12"	0.001mm/0.0001"	±5µm	312.5	23	167.5	5.5

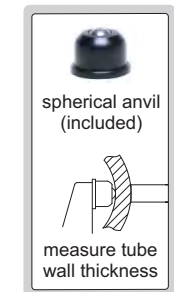

Metric/Inch type (friction thimble)

(mm)

Code	Range	Resolution	Accuracy	L	a	b	c
3101-25FA*	0-25mm/0-1"	0.001mm/0.00005"	±2µm	34.5	6	25	3

Metric type (ratchet stop)

(mm)

Code	Range	Resolution	Accuracy	L	a	b	c
3101-25AJ*	0-25mm	0.001mm	±2µm	34.5	6	25	3
3101-50AJ*	25-50mm	0.001mm	±2µm	59.5	8	32	3
3101-75AJ*	50-75mm	0.001mm	±3µm	84.5	8	44.5	3
3101-100AJ*	75-100mm	0.001mm	±3µm	109.5	8	57	3

Set (ratchet stop type)

Code	Range	Micrometers included	Packaging
3101-753A*	0-75mm/0-3"	3101-25A, 3101-50A, 3101-75A	blow mould case
3101-1004A*	0-100mm/0-4"	3101-25A, 3101-50A, 3101-75A, 3101-100A	blow mould case
3101-1506A	0-150mm/0-6"	3101-25A, 3101-50A, 3101-75A, 3101-100A, 3101-125A, 3101-150A	aluminum box
3101-3006A	150-300mm/6-12"	3101-175A, 3101-200A, 3101-225A, 3101-250A, 3101-275A, 3101-300A	aluminum box



3101-753A

3101-1506A

*Supplied with manufacturer inspection certificate

IP65
WATERPROOF

WATERPROOF DIGITAL OUTSIDE MICROMETERS (WITHOUT DATA OUTPUT)

ATTENTION: NO
DATA OUTPUT

**INSPECTION
CERTIFICATE**



3108-25A

- Resolution 0.001mm/0.00005"
- IP65 dust/waterproof
- Button function: on/off, set, mm/inch, ABS/INC
- No data output
- Automatic power off
- Carbide measuring faces
- Supplied with spherical anvil
- Setting standards are included (except 0-25mm/0-1")

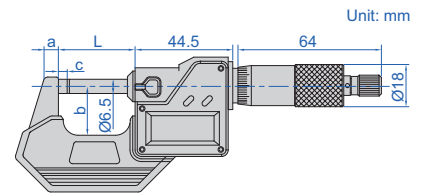

Ratchet stop type (mm)

Code	Range	Accuracy	L	a	b	c
3108-25A*	0-25mm/0-1"	±2µm	34.5	6	25	3
3108-50A*	25-50mm/1-2"	±2µm	59.5	8	32	3
3108-75A*	50-75mm/2-3"	±3µm	84.5	8	44.5	3
3108-100A*	75-100mm/3-4"	±3µm	109.5	8	57	3
3108-125A	100-125mm/4-5"	±3µm	135	10	70	3
3108-150A	125-150mm/5-6"	±3µm	160.5	10	82	3
3108-175A	150-175mm/6-7"	±4µm	186	12	94.5	5.5
3108-200A	175-200mm/7-8"	±4µm	211.5	12	107	5.5

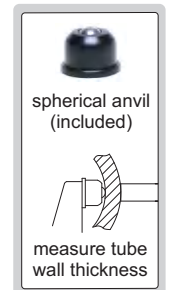

Friction thimble type (mm)

Code	Range	Accuracy	L	a	b	c
3108-25FA*	0-25mm/0-1"	±2µm	34.5	6	25	3



3108-753A



3108-1506A

Set

Code	Range	Micrometers included	Packaging
3108-753A*	0-75mm/0-3"	3108-25A, 3108-50A, 3108-75A	blow mould case
3108-1004A*	0-100mm/0-4"	3108-25A, 3108-50A, 3108-75A, 3108-100A	blow mould case
3108-1506A	0-150mm/0-6"	3108-25A, 3108-50A, 3108-75A, 3108-100A, 3108-125A, 3108-150A	aluminum box

*Supplied with manufacturer inspection certificate

DIGITAL OUTSIDE MICROMETERS (BASIC TYPE, WITH DATA OUTPUT)



DATA OUTPUT

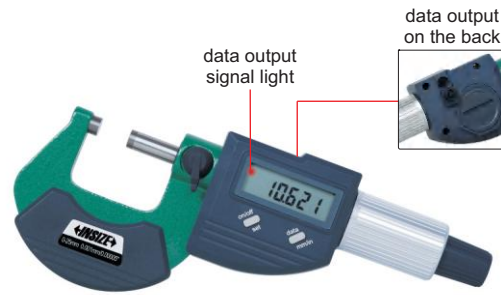

3102-25

- Resolution 0.001mm/0.00005"
- Button function: on/off, set, mm/inch, data transmit
- Automatic power off
- Carbide measuring faces
- Friction thimble
- Supplied with spherical anvil
- Setting standards are included (except 0-25mm/0-1")
- Optional accessory:
 - wireless transmitter code **7315-30** (receiver is needed) page 5,
 - bluetooth transmitter code **7214-30** page 11,
 - data output cable code **7302-30** page 20

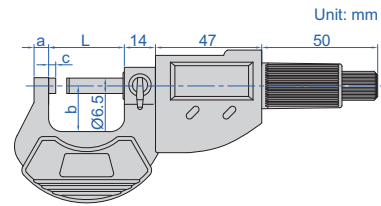

Individual (mm)						
Code	Range	Accuracy	L	a	b	c
3102-25 *	0-25mm/0-1"	±2µm	32	6	24	3
3102-50 *	25-50mm/1-2"	±2µm	57	8	32	3
3102-75 *	50-75mm/2-3"	±3µm	82	8	45	3
3102-100 *	75-100mm/3-4"	±3µm	107	10	57	3
3102-125	100-125mm/4-5"	±3µm	133	10	70	3
3102-150	125-150mm/5-6"	±3µm	158	10	82	3
3102-175	150-175mm/6-7"	±4µm	183	12	95	5.5
3102-200	175-200mm/7-8"	±4µm	209	12	107	5.5

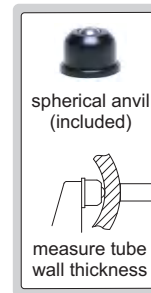

3102-753A



3102-1506A

Set

Code	Range	Micrometers included	Packaging
3102-753A *	0-75mm/0-3"	3102-25, 3102-50, 3102-75	blow mould case
3102-1004A *	0-100mm/0-4"	3102-25, 3102-50, 3102-75, 3102-100	blow mould case
3102-1506A	0-150mm/0-6"	3102-25, 3102-50, 3102-75, 3102-100, 3102-125, 3102-150	aluminum box

* Supplied with manufacturer inspection certificate

POPULAR MODEL

DIGITAL OUTSIDE MICROMETERS (BASIC TYPE, WITHOUT DATA OUTPUT)

INSPECTION CERTIFICATE

ATTENTION: NO DATA OUTPUT

- Resolution 0.001mm/0.00005"
- Button function: on/off, set, mm/inch, ABS/INC
- No data output
- Automatic power off
- Carbide measuring faces
- Friction thimble
- Supplied with spherical anvil
- Setting standards are included (except 0-25mm/0-1")



3109-25A

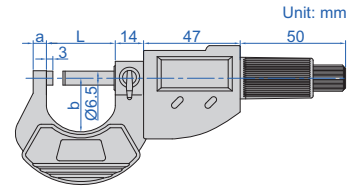

Individual

Code	Range	Accuracy	L	a	b
3109-25A*	0-25mm/0-1"	±2µm	32mm	6mm	28mm
3109-50A*	25-50mm/1-2"	±2µm	57mm	8mm	37mm
3109-75A*	50-75mm/2-3"	±3µm	82mm	8mm	50mm
3109-100A*	75-100mm/3-4"	±3µm	107mm	10mm	61mm
3109-125A	100-125mm/4-5"	±3µm	132mm	10mm	73mm
3109-150A	125-150mm/5-6"	±3µm	157mm	10mm	85mm
3109-175A	150-175mm/6-7"	±4µm	182mm	20mm	104mm
3109-200A	175-200mm/7-8"	±4µm	207mm	20mm	117mm
3109-225A	200-225mm/8-9"	±4µm	234mm	20mm	130mm
3109-250A	225-250mm/9-10"	±4µm	260mm	20mm	143mm
3109-275A	250-275mm/10-11"	±5µm	285mm	20mm	155mm
3109-300A	275-300mm/11-12"	±5µm	310mm	20mm	168mm

Set

Code	Range	Micrometers included	Packaging
3109-753A*	0-75mm/0-3"	3109-25A, 3109-50A, 3109-75A	blow mould case
3109-1004A*	0-100mm/0-4"	3109-25A, 3109-50A, 3109-75A, 3109-100A	blow mould case
3109-1506A	0-150mm/0-6"	3109-25A, 3109-50A, 3109-75A, 3109-100A, 3109-125A, 3109-150A	aluminum box
3109-3006A	150-300mm/6-12"	3109-175A, 3109-200A, 3109-225A, 3109-250A, 3109-275A, 3109-300A	aluminum box

*Supplied with manufacturer inspection certificate

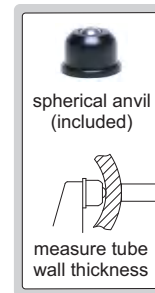

3109-753A



3109-1506A

DIGITAL VERTICAL MICROMETERS

- Measure the thickness of plates for easy reading
- Resolution 0.001mm/0.00005"
- IP65 dust/waterproof
- Button function: on/off, set, mm/inch, ABS/INC
- Data output
- Automatic power off
- Carbide spindle tip
- Ratchet stop
- Supplied with setting standards (except 0-25mm/0-1")
- Optional accessory:
 - wireless transmitter code **7315-30** (receiver is needed) page 5,
 - bluetooth transmitter code **7214-30** page 11,
 - data output cable code **7302-30** page 20



3565-25A

DATA OUTPUT

IP65 WATERPROOF

INSPECTION CERTIFICATE

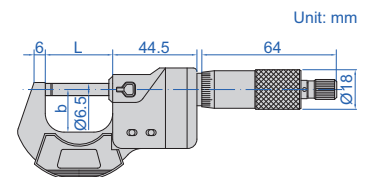

Code	Range	Type	Accuracy	L	b
3565-25A*	0-25mm/0-1"	A	±2µm	34.5mm	25mm
3565-50A*	25-50mm/1-2"	A	±2µm	59.5mm	32mm
3565-25BA*	0-25mm/0-1"	B	±2µm	34.5mm	25mm
3565-50BA*	25-50mm/1-2"	B	±2µm	59.5mm	32mm

*Supplied with manufacturer inspection certificate

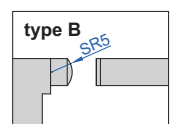
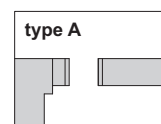

OUTSIDE MICROMETERS

INSIZE PLUS
MADE IN EUROPE

- Carbide measuring faces
- Graduation: 0.01mm
- Meet DIN863-1
- Friction thimble
- Optional accessory: setting standards (code **7386**)

Code	Range	Accuracy	L	b
3701-25A *	0-25mm	4µm	37mm	24mm
3701-50A *	25-50mm	4µm	62mm	34mm
3701-75A *	50-75mm	5µm	87mm	46mm
3701-100A *	75-100mm	5µm	112mm	60mm
3701-125A *	100-125mm	6µm	139mm	72mm
3701-150A *	125-150mm	6µm	164mm	85mm
3701-175A *	150-175mm	7µm	190mm	97mm
3701-200A *	175-200mm	7µm	215mm	110mm
3701-225A *	200-225mm	8µm	240mm	122mm
3701-250A *	225-250mm	8µm	264mm	135mm
3701-275A *	250-275mm	9µm	290mm	148mm
3701-300A *	275-300mm	9µm	315mm	160mm

* Supplied with manufacturer inspection certificate

ATTENTION: SETTING
STANDARDS ARE NOT INCLUDED

INSPECTION
CERTIFICATE



3701-25A

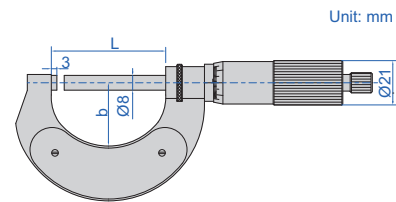

6

OUTSIDE MICROMETERS WITH 50mm RANGE

INSIZE PLUS
MADE IN EUROPE

- Graduation 0.01mm
- Ratchet stop
- One turn of sleeve makes 1mm spindle feed
- Carbide measuring faces
- Optional accessory: setting standards (code **7386**)

ATTENTION: SETTING
STANDARDS ARE NOT INCLUDED

LIGHT
WEIGHT



3682-50

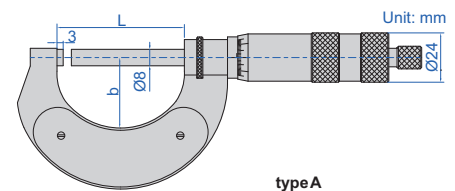

type A

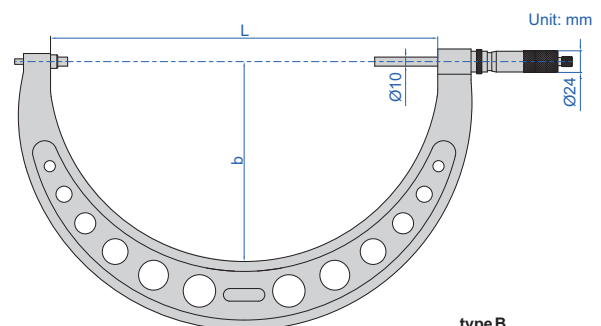

type B

(mm)

Code	Range	Type	Accuracy	L	b	Weight
3682-50	0-50mm	A	4µm	62	34	0.46kg
3682-100	50-100mm	A	5µm	112	60	0.62kg
3682-150	100-150mm	A	6µm	164	85	0.78kg
3682-200	150-200mm	A	7µm	215	110	1.03kg
3682-250	200-250mm	A	8µm	264	135	1.25kg
3682-300	250-300mm	A	9µm	315	160	1.45kg
3682-350	300-350mm	B	10µm	370	190	1.50kg
3682-400	350-400mm	B	11µm	430	220	1.80kg
3682-450	400-450mm	B	12µm	475	250	2.15kg
3682-500	450-500mm	B	13µm	530	273	2.30kg
3682-550	500-550mm	B	14µm	570	291	2.40kg
3682-600	550-600mm	B	14µm	630	323	3.00kg
3682-650	600-650mm	B	16µm	675	351	3.30kg
3682-700	650-700mm	B	16µm	730	378	3.70kg
3682-750	700-750mm	B	18µm	785	401	3.90kg
3682-800	750-800mm	B	18µm	830	423	4.10kg
3682-850	800-850mm	B	20µm	885	440	4.30kg
3682-900	850-900mm	B	20µm	930	473	4.90kg
3682-950	900-950mm	B	22µm	980	503	5.80kg
3682-1000	950-1000mm	B	22µm	1030	520	6.10kg

ATTENTION: SETTING STANDARDS ARE NOT INCLUDED

OUTSIDE MICROMETERS (GRADUATION 0.005mm)

INSIZE PLUS
MADE IN EUROPE

- Graduation 0.005mm
- Friction thimble
- One turn of sleeve makes 0.5mm spindle feed
- Carbide measuring faces
- Optional accessory: setting standards (code **7386**)



3681-25

Code	Range	Accuracy	L	b	(mm)
3681-25	0-25mm	4μm	37	24	
3681-50	25-50mm	4μm	62	34	
3681-75	50-75mm	5μm	87	46	
3681-100	75-100mm	5μm	112	60	
3681-125	100-125mm	6μm	139	72	
3681-150	125-150mm	6μm	164	85	
3681-175	150-175mm	7μm	190	97	
3681-200	175-200mm	7μm	215	110	
3681-225	200-225mm	8μm	240	122	
3681-250	225-250mm	8μm	264	135	
3681-275	250-275mm	9μm	290	148	
3681-300	275-300mm	9μm	315	160	

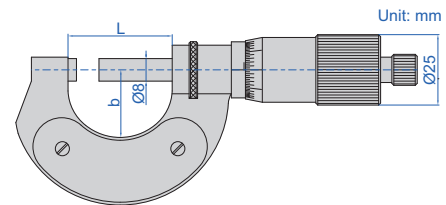

INSPECTION CERTIFICATE

- Graduation 0.01mm
- Carbide measuring faces
- Meet DIN863-1
- Supplied with setting standards (except 0-25mm)

OUTSIDE MICROMETERS

Individual

Code	Range	Accuracy	L	a	b
3202-25A *	0-25mm	4μm	32mm	6mm	24mm
3202-50A *	25-50mm	4μm	57mm	8mm	32mm
3202-75A *	50-75mm	5μm	82mm	8mm	45mm
3202-100A *	75-100mm	5μm	107mm	8mm	57mm
3202-125A	100-125mm	6μm	133mm	8mm	70mm
3202-150A	125-150mm	6μm	125mm	8mm	82mm
3202-175A	150-175mm	7μm	183mm	8mm	95mm
3202-200A	175-200mm	7μm	209mm	8mm	107mm



3202-25A

Set

Code	Range	Micrometers included
3202-753A *	0-75mm	3202-25A, 3202-50A, 3202-75A
3202-1004A *	0-100mm	3202-25A, 3202-50A, 3202-75A, 3202-100A
3202-1506A	0-150mm	3202-25A, 3202-50A, 3202-75A, 3202-100A, 3202-125A, 3202-150A

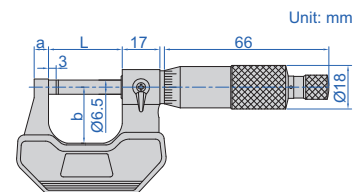

* Supplied with manufacturer inspection certificate

OUTSIDE MICROMETERS

POPULAR MODEL

INSPECTION CERTIFICATE

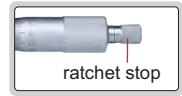

6

- Graduation: metric 0.01mm
inch 0.0001"
- Carbide measuring faces
- Meet DIN863-1
- Supplied with setting standards (except 0-25mm and 0-1")

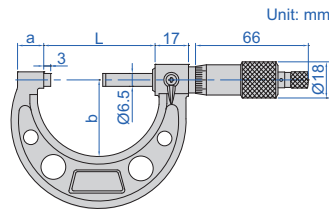

Metric (ratchet stop type)

Code	Range	Accuracy	L	a	b
3203-25A*	0-25mm	±2µm	32mm	9mm	28mm
3203-50A*	25-50mm	±2µm	57mm	14mm	38mm
3203-75A*	50-75mm	±2µm	82mm	15mm	49mm
3203-100A*	75-100mm	±3µm	107mm	15mm	60mm
3203-125A	100-125mm	±3µm	133mm	16.5mm	73mm
3203-150A	125-150mm	±3µm	158mm	16.5mm	85mm
3203-175A	150-175mm	±4µm	183mm	19.4mm	104mm
3203-200A	175-200mm	±4µm	209mm	19.4mm	117mm
3203-225A	200-225mm	±4µm	234mm	19.4mm	130mm
3203-250A	225-250mm	±5µm	260mm	19.4mm	142mm
3203-275A	250-275mm	±5µm	285mm	19.4mm	155mm
3203-300A	275-300mm	±5µm	310mm	19.4mm	168mm



Inch (ratchet stop type)

Code	Range	Accuracy	L	a	b
3203-1A*	0-1"	±0.0001"	1.260"	0.354"	1.102"
3203-2A*	1-2"	±0.0001"	2.244"	0.551"	1.496"
3203-3A*	2-3"	±0.0001"	3.228"	0.591"	1.929"
3203-4A*	3-4"	±0.00015"	4.213"	0.591"	2.362"
3203-5A*	4-5"	±0.00015"	5.236"	0.650"	2.874"
3203-6A*	5-6"	±0.00015"	6.220"	0.650"	3.346"
3203-7A	6-7"	±0.0002"	7.205"	0.764"	4.094"
3203-8A	7-8"	±0.0002"	8.228"	0.764"	4.606"
3203-9A	8-9"	±0.0002"	9.213"	0.764"	5.118"
3203-10A	9-10"	±0.00025"	10.236"	0.764"	5.591"
3203-11A	10-11"	±0.00025"	11.220"	0.764"	6.102"
3203-12A	11-12"	±0.00025"	12.205"	0.764"	6.614"

Metric micrometer set (ratchet stop type)

Code	Range	Micrometers included	Packaging
3203-753A*	0-75mm	3203-25A, 3203-50A, 3203-75A	blow mould case
3203-1004A*	0-100mm	3203-25A, 3203-50A, 3203-75A, 3203-100A	blow mould case
3203-1506A	0-150mm	3203-25A, 3203-50A, 3203-75A, 3203-100A, 3203-125A, 3203-150A	blow mould case
3203-3006A	150-300mm	3203-175A, 3203-200A, 3203-225A, 3203-250A, 3203-275A, 3203-300A	aluminum box
3203-3012A	0-300mm	3203-25A, 3203-50A, 3203-75A, 3203-100A, 3203-125A, 3203-150A, 3203-175A, 3203-200A, 3203-225A, 3203-250A, 3203-275A, 3203-300A	aluminum box

To be continued

Continued from previous page

Inch micrometer set (ratchet stop type)

Code	Range	Micrometers included	Packaging
3203-33A *	0-3"	3203-1A, 3203-2A, 3203-3A	blow mould case
3203-44A *	0-4"	3203-1A, 3203-2A, 3203-3A, 3203-4A	blow mould case
3203-66A *	0-6"	3203-1A, 3203-2A, 3203-3A, 3203-4A, 3203-5A, 3203-6A	blow mould case
3203-126A	6-12"	3203-7A, 3203-8A, 3203-9A, 3203-10A, 3203-11A, 3203-12A	aluminum box
3203-1212A	0-12"	3203-1A, 3203-2A, 3203-3A, 3203-4A, 3203-5A, 3203-6A, 3203-7A, 3203-8A, 3203-9A, 3203-10A, 3203-11A, 3203-12A	aluminum box

Inch (friction thimble type)

Code	Range	Accuracy	L	a	b
3203-1FA *	0-1"	±0.0001"	1.260"	0.354"	1.102"
3203-2FA *	1-2"	±0.0001"	2.244"	0.551"	1.496"
3203-3FA *	2-3"	±0.0001"	3.228"	0.591"	1.929"
3203-4FA *	3-4"	±0.00015"	4.213"	0.591"	2.362"
3203-5FA *	4-5"	±0.00015"	5.236"	0.650"	2.874"
3203-6FA *	5-6"	±0.00015"	6.220"	0.650"	3.346"
3203-7FA	6-7"	±0.0002"	7.205"	0.764"	4.094"
3203-8FA	7-8"	±0.0002"	8.228"	0.764"	4.606"
3203-9FA	8-9"	±0.0002"	9.213"	0.764"	5.118"
3203-10FA	9-10"	±0.00025"	10.236"	0.764"	5.591"
3203-11FA	10-11"	±0.00025"	11.220"	0.764"	6.102"
3203-12FA	11-12"	±0.00025"	12.205"	0.764"	6.614"

* Supplied with manufacturer inspection certificate



1µm GRADUATION OUTSIDE MICROMETERS

- Graduation 0.001mm
- Carbide measuring faces
- Meet DIN863-1
- Supplied with setting standards (except 0-25mm)



3210-25A

Ratchet stop type (mm)

Code	Range	Accuracy	L	a	b
3210-25A *	0-25mm	4µm	32	9	28
3210-50A *	25-50mm	4µm	57	14	38
3210-75A *	50-75mm	5µm	82	15	49
3210-100A *	75-100mm	5µm	107	15	60
3210-125A	100-125mm	6µm	133	16.5	73
3210-150A	125-150mm	6µm	158	16.5	85
3210-175A	150-175mm	7µm	183	19.4	104
3210-200A	175-200mm	7µm	209	19.4	117

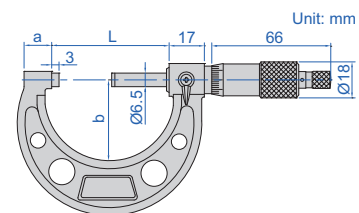

Friction thimble type (mm)

Code	Range	Accuracy	L	a	b
3210-25FA *	0-25mm	4µm	32	9	28
3210-50FA *	25-50mm	4µm	57	14	38

Micrometer set (ratchet stop type)

Code	Range	Micrometers included
3210-753A *	0-75mm	3210-25A, 3210-50A, 3210-75A
3210-1004A *	0-100mm	3210-25A, 3210-50A, 3210-75A, 3210-100A
3210-1506A	0-150mm	3210-25A, 3210-50A, 3210-75A, 3210-100A, 3210-125A, 3210-150A

* Supplied with manufacturer inspection certificate

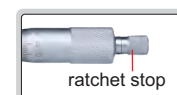

OUTSIDE MICROMETERS WITH COUNTER



- Counter resolution: 0.01mm
- Thimble graduation: 0.01mm
- Carbide measuring faces
- Meet DIN863-1
- Ratchet stop
- Supplied with setting standards (except 0-25mm)



3400-25

Code	Range	Accuracy	L	a	b
3400-25 *	0-25mm	4µm	32mm	6mm	26mm
3400-50 *	25-50mm	4µm	57mm	8mm	32mm
3400-75 *	50-75mm	5µm	82mm	8mm	44.5mm
3400-100 *	75-100mm	5µm	107mm	8mm	57mm
3400-125	100-125mm	6µm	132.4mm	17mm	71.8mm
3400-150	125-150mm	6µm	157.8mm	17mm	84mm
3400-175	150-175mm	7µm	185mm	20mm	98.5mm
3400-200	175-200mm	7µm	210.4mm	20mm	111mm
3400-225	200-225mm	8µm	236mm	20mm	124mm
3400-250	225-250mm	8µm	261mm	20mm	136.5mm
3400-275	250-275mm	9µm	287mm	20mm	149mm
3400-300	275-300mm	9µm	312mm	20mm	162mm

*Supplied with manufacturer inspection certificate

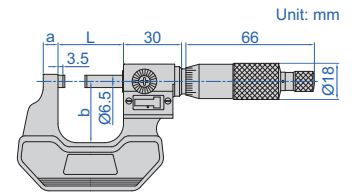

QUICK FEEDING OUTSIDE MICROMETERS

- Graduation 0.01mm
- 1mm feeding of each turn
- Friction thimble
- Carbide measuring faces
- Meet DIN863-1
- Supplied with setting standards (except 0-25mm)



3208-25B

Code	Range	Accuracy	L	a	b
3208-25B	0-25mm	4µm	32mm	6mm	24mm
3208-50B	25-50mm	4µm	57mm	8mm	32mm
3208-75B	50-75mm	5µm	82mm	8mm	45mm
3208-100B	75-100mm	5µm	107mm	8mm	57mm
3208-125B	100-125mm	6µm	133mm	8mm	70mm
3208-150B	125-150mm	6µm	158mm	8mm	82mm
3208-175B	150-175mm	7µm	183mm	8mm	95mm
3208-200B	175-200mm	7µm	209mm	8mm	107mm

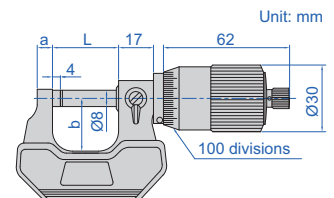

NON MAGNETIC MICROMETERS

- Suitable for magnetic materials
- Graduation: 0.01mm
- Non magnetic carbide measuring faces
- Ratchet stop

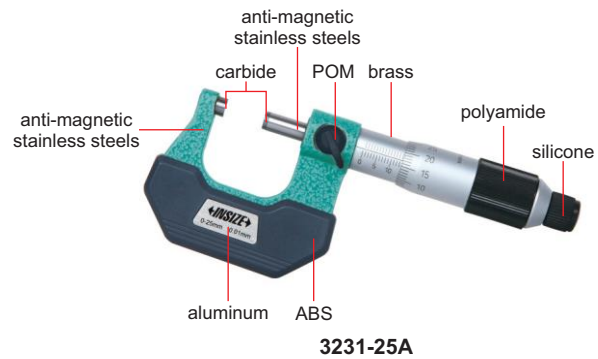

Code	Range	Accuracy	L	b
3231-25A	0-25mm	4μm	32mm	24mm
3231-50A	25-50mm	4μm	57mm	32mm
3231-75A	50-75mm	5μm	82mm	45mm
3231-100A	75-100mm	5μm	105mm	57mm

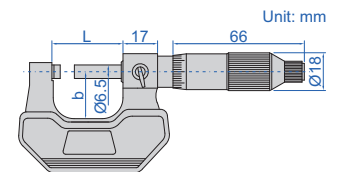

OUTSIDE MICROMETERS FOR LEFT OR RIGHT HANDERS



- Graduation 0.01mm
- Graduations on two sides
- Ratchet stop
- Carbide measuring faces
- Meet DIN863-1
- Supplied with setting standards (except 0-25mm)



3236-25B

Code	Range	Accuracy	L	a	b
3236-25B	0-25mm	4μm	32	6	24
3236-50B	25-50mm	4μm	57	8	32
3236-75B	50-75mm	5μm	82	8	45
3236-100B	75-100mm	5μm	107	8	57
3236-125B	100-125mm	6μm	133	8	70
3236-150B	125-150mm	6μm	158	8	82
3236-175B	150-175mm	7μm	183	8	95
3236-200B	175-200mm	7μm	209	8	107

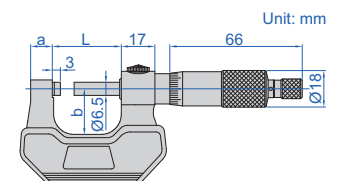

LONG SPINDLE OUTSIDE MICROMETERS



3209-25

- Graduation 0.01mm
- Carbide measuring faces
- Meet DIN863-1
- Ratchet stop
- Supplied with setting standards (except 0-25mm)

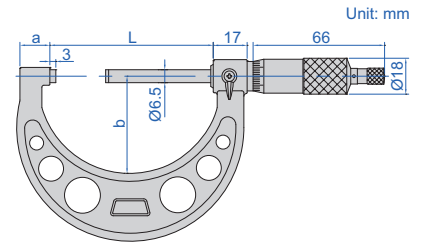

6

Code	Range	Accuracy	L	a	b
3209-25	0-25mm	4 μ m	57mm	14mm	38mm
3209-50	25-50mm	4 μ m	82mm	15mm	49mm
3209-75	50-75mm	5 μ m	107mm	15mm	60mm
3209-100	75-100mm	5 μ m	133mm	16.5mm	73mm

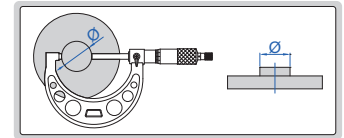
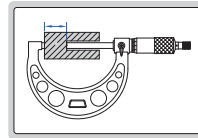

OUTSIDE MICROMETERS (STEEL PLATE FRAME)

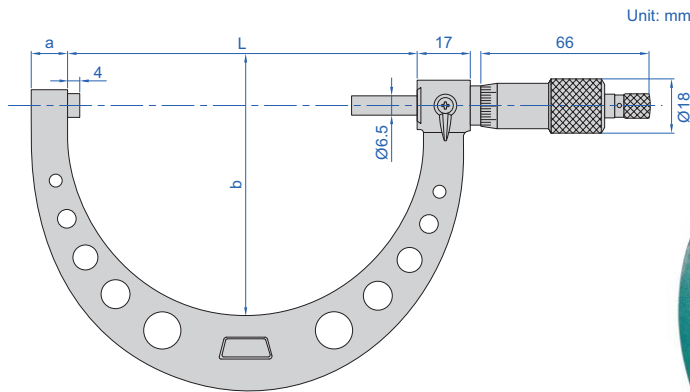

3216-425

- Graduation: 0.01mm
- Carbide measuring faces
- Meet DIN863-1
- Ratchet stop
- Supplied with setting standards

Code	Range	Accuracy	L	a	b
3216-325	300-325mm	10 μ m	338	20	176
3216-350	325-350mm	10 μ m	364	20	192
3216-375	350-375mm	11 μ m	389	20	202
3216-400	375-400mm	11 μ m	414	20	217
3216-425	400-425mm	12 μ m	440	20	226
3216-450	425-450mm	12 μ m	465	20	241
3216-475	450-475mm	13 μ m	491	20	255
3216-500	475-500mm	13 μ m	516	20	268



setting standard (included)

OUTSIDE MICROMETERS WITH INTERCHANGEABLE ANVILS



3206-150A



3206-400

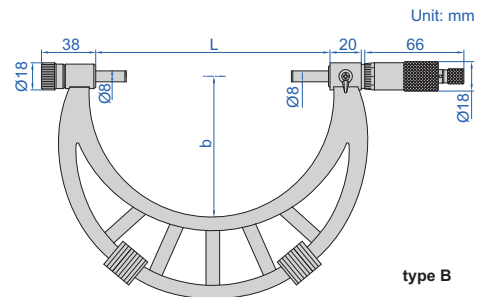
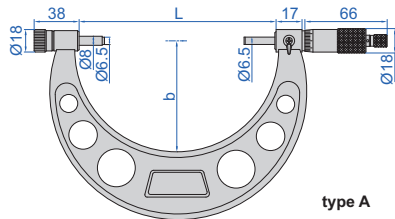

- Graduation 0.01mm
- Ratchet stop
- Meet DIN863-3
- Carbide measuring faces
- Supplied with setting standards

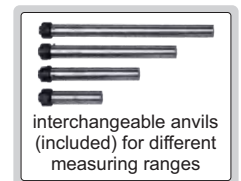
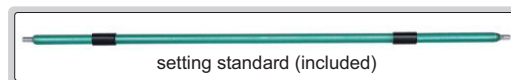

Code	Range	Type	Accuracy	L	b	Setting standard (included)
3206-50A	0-50mm	A	4μm	58	35	25
3206-100A	0-100mm	A	5μm	108	57	25, 50, 75
3206-150A	0-150mm	A	6μm	158	82	25, 50, 75, 100, 125
3206-151A	50-150mm	A	6μm	158	82	50, 75, 100, 125
3206-200A	100-200mm	A	7μm	208	114	100, 125, 150, 175
3206-300A	150-300mm	A	9μm	308	165	150, 175, 200, 225, 250, 275
3206-301A	200-300mm	A	9μm	308	165	200, 225, 250, 275
3206-400	300-400mm	B	11μm	409	224	325, 375
3206-500	400-500mm	B	13μm	509	275	425, 475
3206-600	500-600mm	B	14μm	609	321	525, 575
3206-700	600-700mm	B	16μm	709	371	625, 675
3206-800	700-800mm	B	18μm	809	426	725, 775
3206-900	800-900mm	B	20μm	909	476	825, 875
3206-1000	900-1000mm	B	22μm	1009	576	925, 975

DIGITAL OUTSIDE MICROMETERS WITH INTERCHANGEABLE ANVILS

IP65
WATERPROOF

DATA
OUTPUT

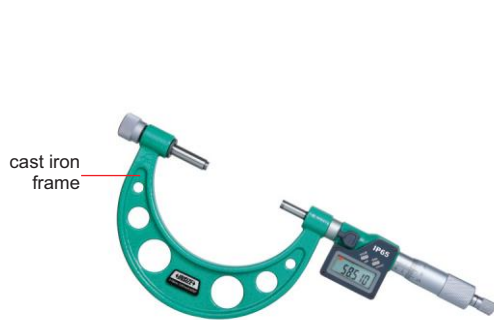

3506-100A



3506-400A

6

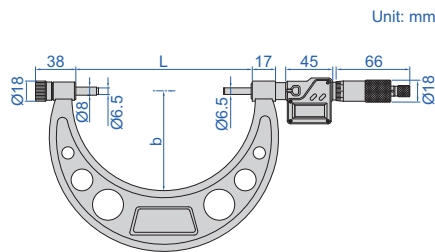

type A

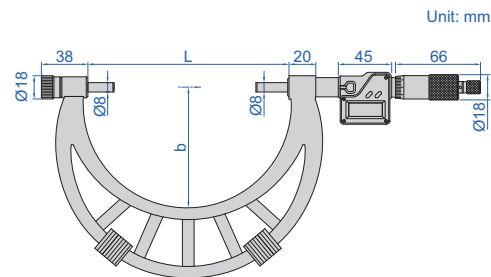

type B

- Resolution 0.001mm/0.0001" (resolution of **3506-100A** and **3506-150A** is 0.001mm/0.00005")
- IP65 dust/waterproof
- Button function: on/off, set, mm/inch, data transmit
- Data output
- Automatic power off
- Ratchet stop
- Carbide measuring faces
- Supplied with setting standards
- Optional accessory: wireless transmitter code **7315-31** (receiver is needed) page 6, bluetooth transmitter code **7214-31** page 12, data output cable code **7302-31** page 20

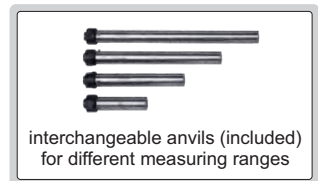

Code	Range	Type	Accuracy	L	b	Setting standard (included)
3506-100A	0-100mm/0-4"	A	±5µm	105	57	25, 50, 75
3506-150A	0-150mm/0-6"	A	±6µm	155	82	25, 50, 75, 100, 125
3506-300A	150-300mm/6-12"	A	±8µm	305	165	150, 175, 200, 225, 250, 275
3506-301A	200-300mm/8-12"	A	±8µm	305	165	200, 225, 250, 275
3506-400A	300-400mm/12-16"	B	±9µm	405	224	325, 375
3506-500A	400-500mm/16-20"	B	±11µm	505	275	425, 475
3506-600A	500-600mm/20-24"	B	±12µm	605	321	525, 575
3506-700A	600-700mm/24-28"	B	±13µm	705	371	625, 675
3506-800A	700-800mm/28-32"	B	±15µm	805	426	725, 775
3506-900A	800-900mm/32-36"	B	±16µm	905	476	825, 875
3506-1000A	900-1000mm/36-40"	B	±17µm	1005	576	925, 975

(mm)

OUTSIDE MICROMETERS WITH INTERCHANGEABLE ANVILS

INSIZE PLUS
MADE IN EUROPE

ATTENTION: SETTING
STANDARDS ARE NOT INCLUDED

LIGHT
WEIGHT

QUICK MEASUREMENT
ONE TURN OF SLEEVE OR RATCHET
STOP MAKES 1MM SPINDLE FEED



3675-300

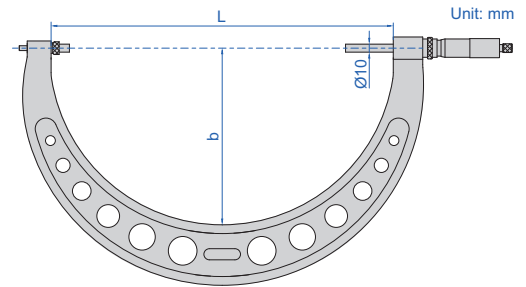

6

- Graduation 0.01mm
- Ratchet stop
- Meet DIN863-3
- Carbide measuring faces
- Light weight
- Optional accessory: setting standards (code 7386)

interchangeable anvil (included)
for different measuring ranges



(mm)

Code	Range	Accuracy	L	b	Weight
3675-200	100-200mm	6µm	240	122	1.2kg
3675-300	200-300mm	6µm	325	165	1.5kg
3675-400	300-400mm	7µm	430	220	1.9kg
3675-500	400-500mm	8µm	530	273	2.4kg
3675-600	500-600mm	9µm	630	323	3.1kg
3675-700	600-700mm	9µm	730	378	3.8kg
3675-800	700-800mm	9µm	830	423	4.2kg
3675-900	800-900mm	10µm	930	473	5kg
3675-1000	900-1000mm	10µm	1030	520	6.2kg
3675-1100	1000-1100mm	11µm	1135	585	7.6kg
3675-1200	1100-1200mm	11µm	1230	635	8.6kg
3675-1300	1200-1300mm	12µm	1335	685	9.7kg
3675-1400	1300-1400mm	12µm	1430	735	11.3kg
3675-1500	1400-1500mm	13µm	1530	780	12.5kg
3675-1600	1500-1600mm	18µm	1660	840	13.6kg
3675-1700	1600-1700mm	19µm	1765	890	14.9kg
3675-1800	1700-1800mm	20µm	1870	940	16.2kg
3675-1900	1800-1900mm	21µm	1970	1000	17.5kg
3675-2000	1900-2000mm	22µm	2075	1055	18.8kg

OUTSIDE MICROMETERS WITH EXTENSION ANVIL COLLAR

6

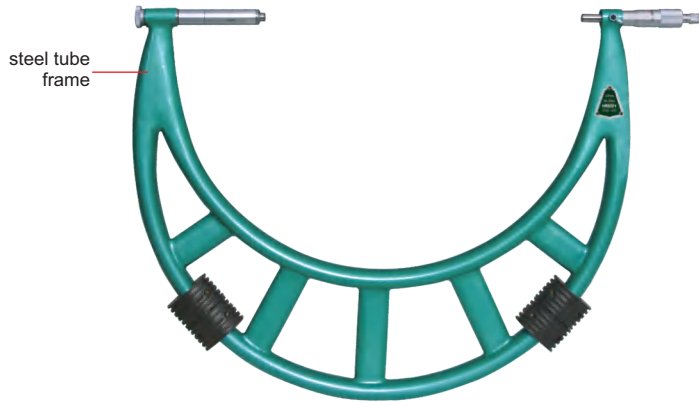

3205-400

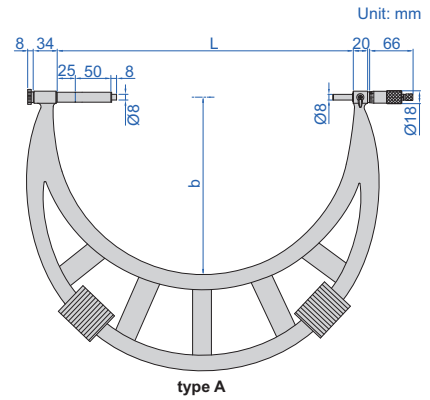

type A



adjust collars for different measuring ranges

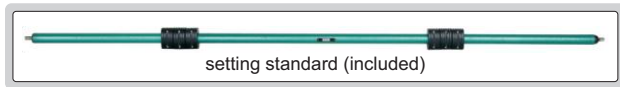

setting standard (included)

- Graduation 0.01mm
- Adjust collars for different measuring ranges
- Ratchet stop
- Carbide measuring faces
- Supplied with setting standards

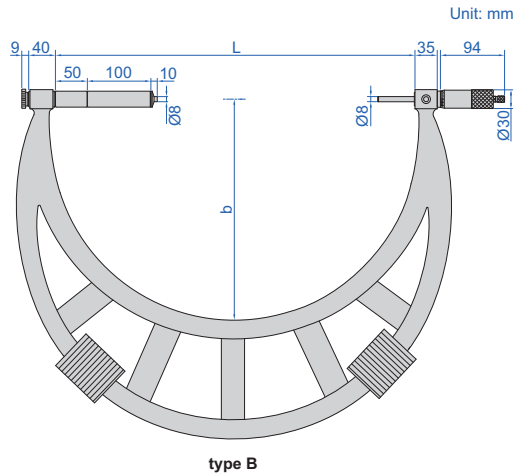

type B

(mm)

Code	Range	Type	Accuracy	L	b	Setting standard (included)
3205-400	300-400mm	A	11µm	410	250	325, 375
3205-500	400-500mm	A	13µm	510	295	425, 475
3205-600	500-600mm	A	14µm	610	345	525, 575
3205-700	600-700mm	A	16µm	710	395	625, 675
3205-800	700-800mm	A	18µm	810	445	725, 775,
3205-900	800-900mm	A	20µm	910	495	825, 875
3205-1000	900-1000mm	A	22µm	1010	545	925, 975
3205-1200	1000-1200mm	B	22µm	1210	645	1050, 1150
3205-1400	1200-1400mm	B	24µm	1410	745	1250, 1350
3205-1600	1400-1600mm	B	28µm	1610	845	1450, 1550
3205-1800	1600-1800mm	B	31µm	1810	945	1650, 1750
3205-2000	1800-2000mm	B	34µm	2010	1045	1850, 1950

LIMIT MICROMETERS

- Used as Go/No-Go gauge by setting upper and lower limits
- Graduation 0.002mm
- Carbide measuring faces
- Supplied with setting standard (except 0-25mm)

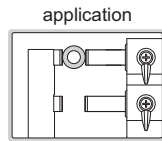

3235-25A

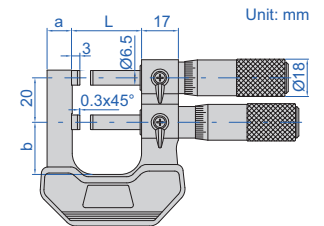

Code	Range	Accuracy	L	a	b
3235-25A	0-25mm	4µm	32mm	12mm	24mm
3235-50A	25-50mm	4µm	57mm	15mm	32mm

ATTENTION: SETTING STANDARDS ARE NOT INCLUDED



INDICATING MICROMETERS



3333-25

- Meet DIN863-3
- Carbide measuring faces
- Measuring force 5-10N
- Dial can be adjusted
- Optional accessory: gauge blocks grade 0 (4101-A series), for zero setting

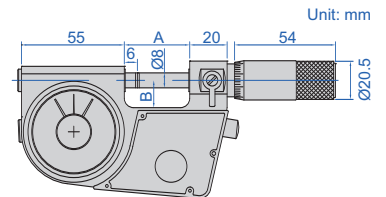

(mm)

Code	Micrometer head			Dial indicator			A	B
	range	graduation	accuracy	range	graduation	accuracy		
3333-25 *	0-25mm	0.01mm	4µm	±0.07mm	1µm	±1µm	35.5	15
3333-252 *	0-25mm	0.01mm	4µm	±0.14mm	2µm	±2µm	35.5	15
3333-50 *	25-50mm	0.01mm	4µm	±0.07mm	1µm	±1µm	60.5	25
3333-502 *	25-50mm	0.01mm	4µm	±0.14mm	2µm	±2µm	60.5	25
3333-75 *	50-75mm	0.01mm	4µm	±0.07mm	1µm	±1µm	88	37.5
3333-752 *	50-75mm	0.01mm	4µm	±0.14mm	2µm	±2µm	88	37.5
3333-100 *	75-100mm	0.01mm	4µm	±0.07mm	1µm	±1µm	111	50
3333-1002 *	75-100mm	0.01mm	4µm	±0.14mm	2µm	±2µm	111	50
3333-125 *	100-125mm	0.01mm	4µm	±0.07mm	1µm	±1µm	136	62.5
3333-1252 *	100-125mm	0.01mm	4µm	±0.14mm	2µm	±2µm	136	62.5
3333-150 *	125-150mm	0.01mm	4µm	±0.07mm	1µm	±1µm	161	75
3333-1502 *	125-150mm	0.01mm	4µm	±0.14mm	2µm	±2µm	161	75
3333-175 *	150-175mm	0.01mm	4µm	±0.14mm	2µm	±2µm	186	88
3333-200 *	175-200mm	0.01mm	4µm	±0.14mm	2µm	±2µm	211	101
3333-225 *	200-225mm	0.01mm	4µm	±0.14mm	2µm	±2µm	236	113
3333-250 *	225-250mm	0.01mm	4µm	±0.14mm	2µm	±2µm	261	126
3333-275 *	250-275mm	0.01mm	4µm	±0.14mm	2µm	±2µm	286	138
3333-300 *	275-300mm	0.01mm	4µm	±0.14mm	2µm	±2µm	311	151

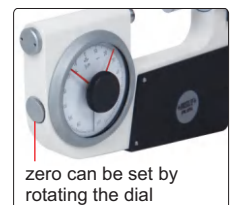

* Supplied with manufacturer inspection certificate

BLUETOOTH DIGITAL INDICATING MICROMETERS

IP54
WATERPROOF

BUILT-IN
BLUETOOTH

ATTENTION: SETTING
STANDARDS ARE NOT INCLUDED

ABSOLUTE ENCODER, THE ORIGINAL
DATA REMAINS AFTER POWER OFF



3507-25

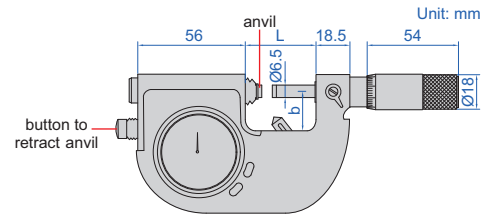

6

- Meet DIN863-3
- Absolute encoder, the original data remains after power off
- Measuring stroke of anvil: 3mm
- Reading in digital and analog
- Button function: on/off, zero setting, mm/inch, tolerance, display setting, bluetooth, signal mode setting, data output
- Android and iPhone APP, USB type-C cable are included
- Carbide measuring faces
- Power: rechargeable Li-battery, for 20 hours continuous working (bluetooth transmission reduces working hours)
- Optional accessory: gauge blocks grade 0 (4101-A series), for zero setting

warning in red or yellow when over tolerance

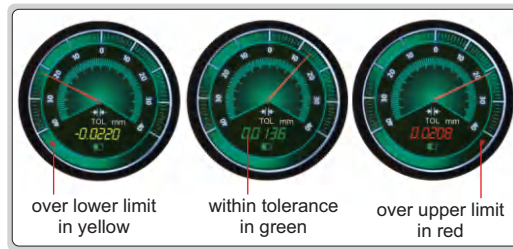

charge pal



(mm)

Code	Micrometer head			Digital indicator			Repeatability	L	b	Remarks
	range	graduation	accuracy	range	resolution	accuracy				
3507-25	0-25mm	0.002mm	3μm	±0.04mm	0.1μm	±1μm	0.3μm	35.5	15	includes charge pal
3507-50	25-50mm	0.002mm	3μm	±0.04mm	0.1μm	±1μm	0.3μm	60.5	25	includes charge pal
3507-75	50-75mm	0.002mm	3μm	±0.04mm	0.1μm	±1μm	0.3μm	86	37.5	includes charge pal
3507-100	75-100mm	0.002mm	3μm	±0.04mm	0.1μm	±1μm	0.3μm	111	50	includes charge pal
3507-25B	0-25mm	0.002mm	3μm	±0.04mm	0.2μm	±1μm	0.3μm	35.5	15	—
3507-50B	25-50mm	0.002mm	3μm	±0.04mm	0.2μm	±1μm	0.3μm	60.5	25	—
3507-75B	50-75mm	0.002mm	3μm	±0.04mm	0.2μm	±1μm	0.3μm	86	37.5	—
3507-100B	75-100mm	0.002mm	3μm	±0.04mm	0.2μm	±1μm	0.3μm	111	50	—

Data output

Data output with bluetooth (transmission distance is 10 meters)	keyboard format	data can be transmitted to Excel, Word, txt, etc.	single transmission
	virtual com port	data can be transmitted to Android and iPhone APP	real-time display, data can be transmitted and exported
Data output with USB cable (cable length 1.8 meters)	keyboard format	data can be transmitted to Excel, Word, txt, etc.	single transmission
	virtual com port	data can be transmitted to serial communication software	single transmission

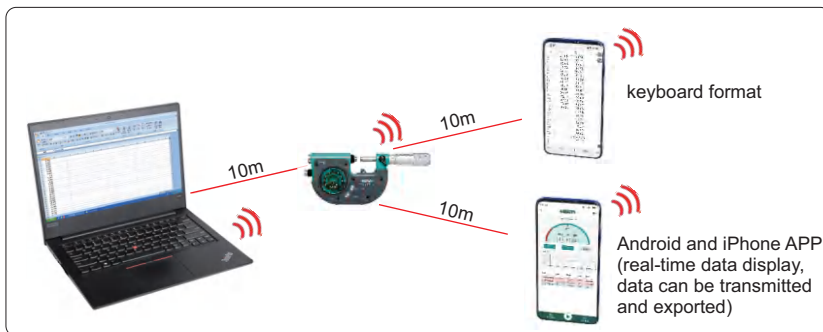

data output with bluetooth (included)



data output with USB cable (included)

IP54
WATERPROOF

ABSOLUTE ENCODER, THE ORIGINAL DATA REMAINS AFTER POWER OFF

ATTENTION: SETTING STANDARDS ARE NOT INCLUDED

DIGITAL INDICATING MICROMETERS (WITHOUT DATA OUTPUT)



3508-25

- Meet DIN863-3
- Absolute encoder, the original data remains after power off
- Measuring stroke of anvil: 3mm
- Reading in digital and analog
- Button function: on/off, zero setting, mm/inch, tolerance, display setting
- Carbide measuring faces
- Power: rechargeable Li-battery, for 20 hours continuous working
- Optional accessory: gauge blocks grade 0 (4101-A series), for zero setting

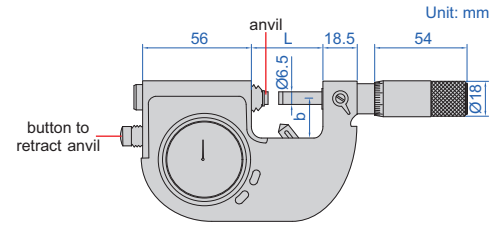

warning in red or yellow when over tolerance

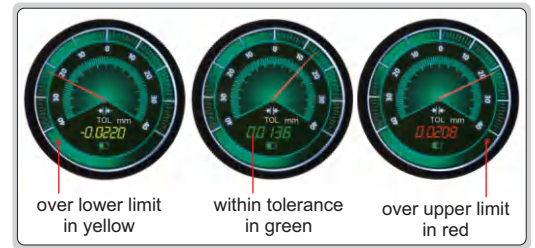

6

(mm)

Code	Micrometer head			Digital indicator			Repeatability	L	b
	range	graduation	accuracy	range	resolution	accuracy			
3508-25	0-25mm	0.002mm	3µm	±0.04mm	0.2µm	±1µm	0.3µm	35.5	15
3508-50	25-50mm	0.002mm	3µm	±0.04mm	0.2µm	±1µm	0.3µm	60.5	25
3508-75	50-75mm	0.002mm	3µm	±0.04mm	0.2µm	±1µm	0.3µm	86	37.5
3508-100	75-100mm	0.002mm	3µm	±0.04mm	0.2µm	±1µm	0.3µm	111	50
3508-25B	0-25mm	0.002mm	3µm	±0.04mm	0.5µm	±1µm	0.3µm	35.5	15
3508-50B	25-50mm	0.002mm	3µm	±0.04mm	0.5µm	±1µm	0.3µm	60.5	25
3508-75B	50-75mm	0.002mm	3µm	±0.04mm	0.5µm	±1µm	0.3µm	86	37.5
3508-100B	75-100mm	0.002mm	3µm	±0.04mm	0.5µm	±1µm	0.3µm	111	50

ATTENTION: SETTING STANDARDS ARE NOT INCLUDED

INDICATING MICROMETERS

- Meet DIN863-3
- Micrometer head graduation: 0.002mm
- Dial indicator: range ±0.04mm, graduation 0.001mm, accuracy 0.001mm
- Carbide measuring faces
- Optional accessory: gauge blocks grade 0 (4101-A series), for zero setting



3332-25



3332-25B

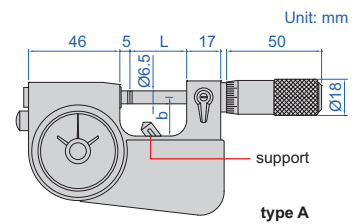

type A

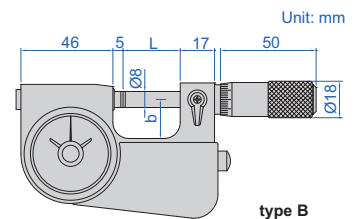

type B

(mm)

Code	Micrometer head range	Micrometer head accuracy	Type	L	b	Remark
3332-25	0-25mm	4µm	A	28.5	19	with support
3332-50	25-50mm	4µm	A	53.5	30	with support
3332-75	50-75mm	5µm	A	78.5	45	without support
3332-100	75-100mm	5µm	A	103.5	57	without support
3332-25B	0-25mm	4µm	B	28.5	19	without support

MICROMETERS WITH DIAL INDICATOR

INSIZE PLUS
MADE IN EUROPE

ATTENTION: SETTING
STANDARDS ARE NOT INCLUDED

INSPECTION
CERTIFICATE

digital indicator
is optional



3346-25

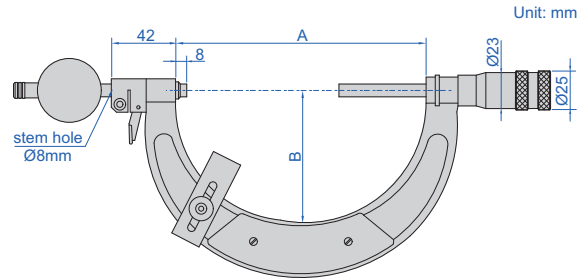

6

(mm)

Code	Micrometer head range	Micrometer head graduation	Micrometer head accuracy	A	B
3346-25 *	0-25mm	5µm	4µm	37	24
3346-50 *	25-50mm	5µm	4µm	62	34
3346-75 *	50-75mm	5µm	5µm	87	46
3346-100 *	75-100mm	5µm	5µm	112	60
3346-150 *	100-150mm	5µm	6µm	164	85
3346-200 *	150-200mm	5µm	7µm	215	110
3346-250 *	200-250mm	5µm	8µm	264	135
3346-300 *	250-300mm	5µm	9µm	315	160

- Anvil retracting range: 2.5mm
- Carbide measuring faces
- Parallelism of measuring faces: 1µm
- Optional accessory: dial indicator (code 2890-1F), digital indicator, gauge blocks grade 1 (4101-B series), for zero setting

* Supplied with manufacturer inspection certificate

MICROMETERS WITH DIAL INDICATOR

ATTENTION: NOT SUITABLE
FOR 0.001MM DIAL INDICATORS

- Meet DIN863-3
- Micrometer head graduation 0.01mm
- Anvil retracting range: 8mm
- Carbide measuring faces
- Supplied with setting standards (except 0-25mm)
- Optional accessory: dial indicators (graduation 0.01mm), digital indicators (resolution 0.01mm/0.0005")



3331-25A

Code	Micrometer head range	Micrometer head accuracy	L	b
3331-25A	0-25mm	4µm	67mm	38mm
3331-50A	25-50mm	4µm	92.4mm	50mm
3331-75A	50-75mm	5µm	117.6mm	62mm
3331-100A	75-100mm	5µm	143mm	70mm
3331-125A	100-125mm	6µm	168.2mm	82mm
3331-150A	125-150mm	6µm	192mm	94.5mm
3331-175A	150-175mm	7µm	217mm	107mm

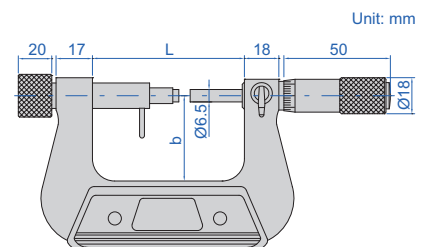

ATTENTION: SETTING STANDARDS ARE NOT INCLUDED

LIGHT WEIGHT

MICROMETERS WITH DIAL INDICATOR

INSIZE PLUS
MADE IN EUROPE

digital indicator is optional



spindle retract fork

3685-300

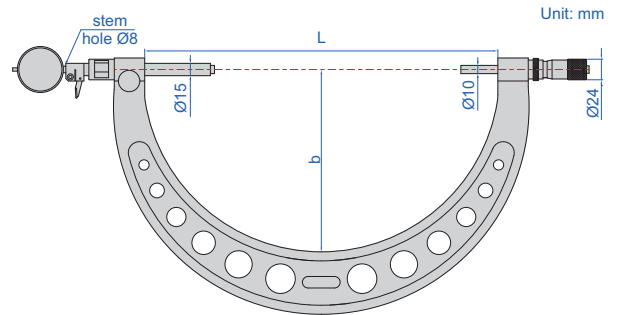

- Graduation 0.01mm
- Anvil with vernier graduation, convenient adjustment for different measuring ranges
- Meet DIN863-3
- Carbide measuring faces
- Anvil retracting range: 2.5mm
- Optional accessory: dial/digital indicators, setting standards (code **7386**)

anvil with vernier graduation, can be adjusted for different measuring ranges



Range 100mm

(mm)

Code	Range	Micrometer head accuracy	L	b	Weight
3685-300	200-300mm	6µm	320	165	1.7kg
3685-400	300-400mm	7µm	430	220	2.1kg
3685-500	400-500mm	8µm	530	273	2.6kg
3685-600	500-600mm	9µm	630	323	3.3kg
3685-700	600-700mm	9µm	730	378	4.0kg
3685-800	700-800mm	9µm	830	423	4.4kg
3685-900	800-900mm	10µm	930	473	5.2kg
3685-1000	900-1000mm	10µm	1030	520	6.4kg

Range 200mm

(mm)

Code	Range	Micrometer head accuracy	L	b	Weight
3685-402	200-400mm	7µm	430	220	2.2kg
3685-602	400-600mm	9µm	630	323	3.4kg
3685-802	600-800mm	9µm	830	423	4.5kg
3685-1002	800-1000mm	10µm	1030	520	6.5kg
3685-1202	1000-1200mm	11µm	1230	635	8.9kg
3685-1402	1200-1400mm	12µm	1430	735	11.6kg
3685-1602	1400-1600mm	18µm	1660	840	13.9kg
3685-1802	1600-1800mm	20µm	1870	940	16.5kg
3685-2002	1800-2000mm	22µm	2075	1055	19.1kg

MICROMETERS WITH DIAL INDICATOR

ATTENTION: NOT SUITABLE FOR 0.001MM DIAL INDICATORS



3296-100A

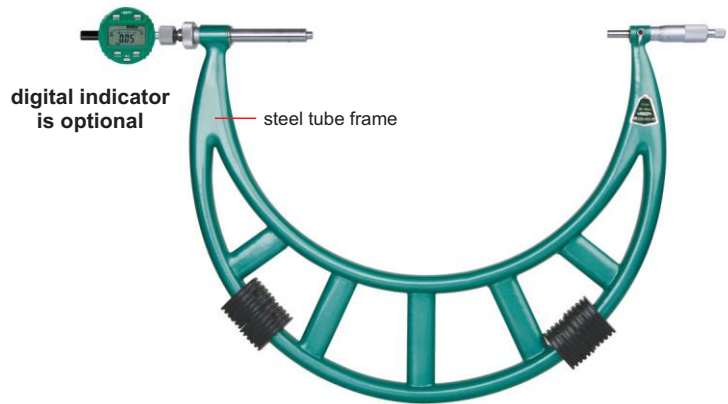
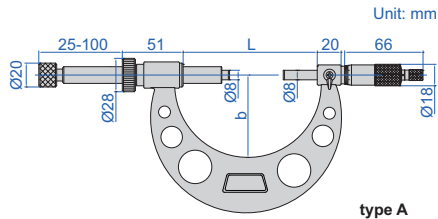

3296-400A

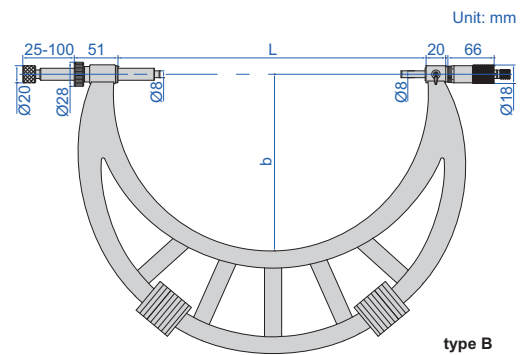

Code	Range	Type	Accuracy	L	b
3296-100A	0-100mm	A	6µm	115	68
3296-200A	100-200mm	A	7µm	215	120
3296-300A	200-300mm	A	8µm	315	170
3296-400A	300-400mm	B	9µm	415	225
3296-500A	400-500mm	B	10µm	515	275
3296-600A	500-600mm	B	11µm	615	325
3296-700A	600-700mm	B	12µm	715	375
3296-800A	700-800mm	B	13µm	815	430
3296-900A	800-900mm	B	14µm	915	480
3296-1000A	900-1000mm	B	15µm	1015	530

- Meet DIN863-3
- Graduation 0.01mm
- Ratchet stop
- Carbide measuring faces
- Supplied with setting standards
- Optional accessory: dial indicators (graduation 0.01mm) digital indicators (resolution 0.01mm/0.0005")

GROOVE MICROMETERS



3287-50B

- Measure width of grooves inside bores
- Graduation 0.01mm
- Two graduations for inside and outside measurements
- Non-rotating spindle
- Two-directional ratchet stop

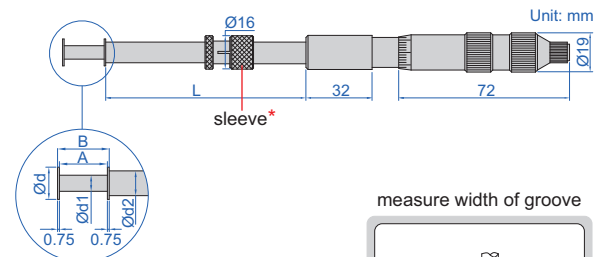

Code	Range (outside A)	Range (inside B)	Accuracy	L	Ød	Ød1	Ød2
3287-25B	0-25mm	1.6-26.5mm	10µm	120	13	6.5	10
3287-50B	25-50mm	26.5-51.5mm	10µm	120	13	6.5	10
3287-75B	50-75mm	51.5-76.5mm	10µm	120	13	6.5	10
3287-100B	75-100mm	76.5-101.5mm	10µm	120	13	6.5	10
3287-125B	100-125mm	101.5-126.5mm	15µm	120	13	6.5	10
3287-150B	125-150mm	126.5-151.5mm	15µm	120	13	6.5	10
3287-251B*	0-25mm	1.6-26.5mm	10µm	90	6.5	3	5

*3287-251B does not have sleeve

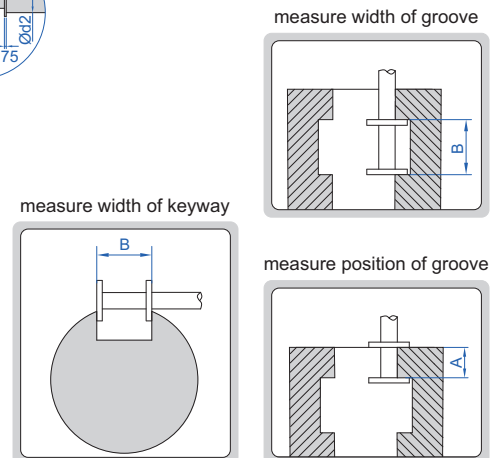

3-WIRES

application



**INSPECTION
CERTIFICATE**

- Used with standard outside micrometers to measure pitch diameter of screw threads
- Diameter accuracy: $\pm 0.5\mu\text{m}$
- Cylindricity: $1\mu\text{m}$
- Hardness: HRC60
- Supplied with manufacturer inspection certificate
- Scope of application: outside diameter of thread $\leq 50\text{mm}$



7382-19

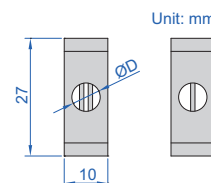

Unit: mm

For outside micrometers with spindle $\text{Ø}6.35\text{mm}$ (ØD)

Code	Pin gauge diameter	Applicable pitch
7382-11	$\text{Ø}0.170\text{mm}$	0.2mm, 0.25mm, 0.3mm
7382-12	$\text{Ø}0.195\text{mm}$	0.35mm
7382-13	$\text{Ø}0.220\text{mm}$	0.4mm
7382-14	$\text{Ø}0.250\text{mm}$	0.45mm
7382-15	$\text{Ø}0.290\text{mm}$	0.5mm
7382-16	$\text{Ø}0.335\text{mm}$	0.6mm
7382-17	$\text{Ø}0.390\text{mm}$	0.7mm
7382-18	$\text{Ø}0.455\text{mm}$	0.75mm, 0.8mm
7382-19	$\text{Ø}0.530\text{mm}$	0.9mm
7382-110	$\text{Ø}0.620\text{mm}$	1.0mm
7382-111	$\text{Ø}0.725\text{mm}$	1.25mm
7382-112	$\text{Ø}0.895\text{mm}$	1.5mm
7382-113	$\text{Ø}1.100\text{mm}$	1.75mm, 2.0mm
7382-114	$\text{Ø}1.350\text{mm}$	2.5mm
7382-115	$\text{Ø}1.650\text{mm}$	3.0mm
7382-116	$\text{Ø}2.050\text{mm}$	3.5mm
7382-117	$\text{Ø}2.550\text{mm}$	4mm, 4.5mm
7382-118	$\text{Ø}3.200\text{mm}$	5mm, 5.5mm, 6mm
7382-1S	18 pairs/set, including all above 3-wires	

For outside micrometers with spindle $\text{Ø}6.50\text{mm}$ (ØD)

Code	Pin gauge diameter	Applicable pitch
7382-21	$\text{Ø}0.170\text{mm}$	0.2mm, 0.25mm, 0.3mm
7382-22	$\text{Ø}0.195\text{mm}$	0.35mm
7382-23	$\text{Ø}0.220\text{mm}$	0.4mm
7382-24	$\text{Ø}0.250\text{mm}$	0.45mm
7382-25	$\text{Ø}0.290\text{mm}$	0.5mm
7382-26	$\text{Ø}0.335\text{mm}$	0.6mm
7382-27	$\text{Ø}0.390\text{mm}$	0.7mm
7382-28	$\text{Ø}0.455\text{mm}$	0.75mm, 0.8mm
7382-29	$\text{Ø}0.530\text{mm}$	0.9mm
7382-210	$\text{Ø}0.620\text{mm}$	1.0mm
7382-211	$\text{Ø}0.725\text{mm}$	1.25mm
7382-212	$\text{Ø}0.895\text{mm}$	1.5mm
7382-213	$\text{Ø}1.100\text{mm}$	1.75mm, 2.0mm
7382-214	$\text{Ø}1.350\text{mm}$	2.5mm
7382-215	$\text{Ø}1.650\text{mm}$	3.0mm
7382-216	$\text{Ø}2.050\text{mm}$	3.5mm
7382-217	$\text{Ø}2.550\text{mm}$	4mm, 4.5mm
7382-218	$\text{Ø}3.200\text{mm}$	5mm, 5.5mm, 6mm
7382-2S	18 pairs/set, including all above 3-wires	

6

**INSPECTION
CERTIFICATE**

3-WIRES

CUSTOMIZABLE
DIAMETER Ød

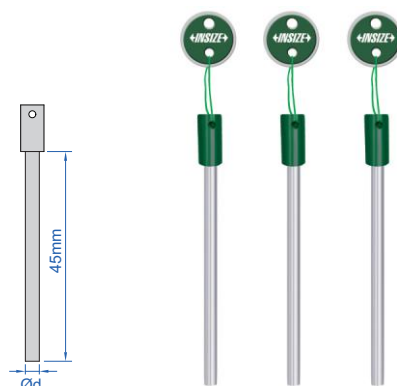

7394-75A

- $\text{Ød} \leq 0.3\text{mm}$, made of alloy steel, hardness HRC60;
- $\text{Ød} > 0.3\text{mm}$, made of carbide, hardness HRA90
- Diameter accuracy: $\pm 0.5\mu\text{m}$
- Cylindricity: $\pm 0.5\mu\text{m}$
- Supplied with manufacturer inspection certificate

Code	Diameter (Ød)	Applicable pitch
7394-60A*	0.170mm	0.2mm, 0.25mm, 0.3mm
7394-61A*	0.195mm	0.35mm
7394-62A*	0.220mm	0.4mm
7394-63A*	0.250mm	0.45mm
7394-64A*	0.290mm	0.5mm
7394-65A	0.335mm	0.6mm
7394-66A	0.390mm	0.7mm
7394-67A	0.455mm	0.75mm, 0.8mm
7394-68A	0.530mm	0.9mm
7394-69A	0.620mm	1.0mm
7394-70A	0.725mm	1.25mm
7394-71A	0.895mm	1.5mm
7394-72A	1.100mm	1.75mm, 2.0mm
7394-73A	1.350mm	2.5mm
7394-74A	1.650mm	3.0mm
7394-75A	2.050mm	3.5mm
7394-76A	2.550mm	4mm, 4.5mm
7394-77A	3.200mm	5mm, 5.5mm, 6mm

*Made of alloy steel

EXTERNAL SCREW THREAD MICROMETERS

INSIZE PLUS
MADE IN EUROPE

**INSPECTION
CERTIFICATE**



3680-50

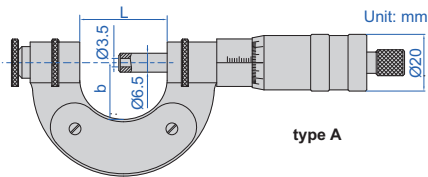

3680-4001

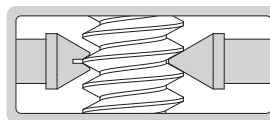
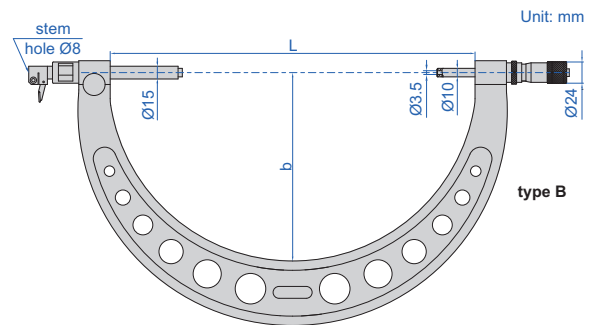

- Measure pitch diameter of screw threads
- Graduation 0.01mm
- Optional accessory: setting standards (code **7384**), external tread tips (code **7390**), dial/digital indicators (only for type B)

Type A (ratchet stop) (mm)

Code	Range	Accuracy	L	b
3680-25 *	0-25mm	4µm	37	24
3680-50 *	25-50mm	4µm	62	34
3680-75 *	50-75mm	4µm	87	46
3680-100 *	75-100mm	4µm	112	60
3680-125 *	100-125mm	5µm	139	72
3680-150 *	125-150mm	5µm	164	85
3680-200 *	150-200mm	7µm	215	110
3680-250 *	200-250mm	7µm	264	135
3680-300 *	250-300mm	7µm	315	160

Type B (without ratchet stop) (mm)

Code	Range	Left anvil retracting stroke	Micrometer head accuracy	L	b
3680-3001 *	200-300mm	2.5mm	6µm	320	165
3680-4001 *	300-400mm	2.5mm	7µm	430	220
3680-5001 *	400-500mm	2.5mm	8µm	530	273
3680-6001 *	500-600mm	2.5mm	9µm	630	323
3680-7001 *	600-700mm	2.5mm	9µm	730	378
3680-8001 *	700-800mm	2.5mm	9µm	830	423
3680-9001 *	800-900mm	2.5mm	10µm	930	473
3680-10001 *	900-1000mm	2.5mm	10µm	1030	520
3680-4002 *	200-400mm	2.5mm	7µm	430	220
3680-6002 *	400-600mm	2.5mm	9µm	630	323
3680-8002 *	600-800mm	2.5mm	9µm	830	423
3680-10002 *	800-1000mm	2.5mm	10µm	1030	520
3680-12002 *	1000-1200mm	2.5mm	11µm	1230	635
3680-14002 *	1200-1400mm	2.5mm	12µm	1430	735
3680-16002 *	1400-1600mm	2.5mm	18µm	1660	840
3680-18002 *	1600-1800mm	2.5mm	20µm	1870	940
3680-20002 *	1800-2000mm	2.5mm	22µm	2075	1055

* Supplied with manufacturer inspection certificate

MEASURING TIPS FOR EXTERNAL SCREW THREAD MICROMETERS

INSIZE PLUS
MADE IN EUROPE

- Supplied in pair
- Made of hardened steel
- Suitable for 3680 series micrometers



7390-T104

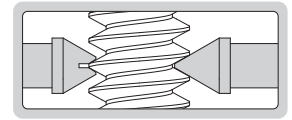
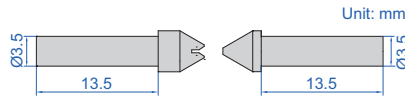

60° thread angle

Code	Pitch
7390-T101	0.35-0.5mm/72-48TPI
7390-T102	0.6-0.8mm/44-32TPI
7390-T103	0.9-1.25mm/28-18TPI
7390-T104	1.5-2mm/16-11TPI
7390-T105	2.5-3.5mm/10-7TPI
7390-T106	4-6mm/6-4TPI

55° thread angle

Code	Pitch
7390-T201	60-48TPI
7390-T202	40-32TPI
7390-T203	28-22TPI
7390-T204	20-16TPI
7390-T205	14-11TPI
7390-T206	10-7TPI
7390-T207	6-4TPI

30° thread angle

Code	Pitch
7390-T301	1.5mm
7390-T302	2mm
7390-T303	3mm
7390-T304	4mm
7390-T305	5-6mm
7390-T306	7-8mm
7390-T307	9-10mm
7390-T308	12-14mm

SETTING STANDARDS FOR EXTERNAL SCREW THREAD MICROMETERS

INSIZE PLUS
MADE IN EUROPE

ATTENTION: WHEN PITCH <0.4MM OR >63.5TPI,
SETTING STANDARDS CANNOT BE USED TO SET ZERO,
A CALIBRATED WORK PIECE CAN BE USED INSTEAD

TIPS FOR TRAPEZOIDAL, ACME
THREAD ARE ALSO AVAILABLE



7384-A100



- Made of hardened steel
- Deviation (difference between the ordered size and the size marked on the setting standard when supplied): $\pm 20\mu\text{m}$
For example, the ordered size is 25mm, the size marked on the setting standard when supplied may be 25.015mm

60° thread angle

Code	L	Ød	Accuracy
7384-A25	25	7.8	$\pm 2.5\mu\text{m}$
7384-A50	50	7.8	$\pm 3\mu\text{m}$
7384-A75	75	7.8	$\pm 3.5\mu\text{m}$
7384-A100	100	7.8	$\pm 4\mu\text{m}$
7384-A125	125	7.8	$\pm 4.5\mu\text{m}$
7384-A150	150	7.8	$\pm 5\mu\text{m}$
7384-A175	175	7.8	$\pm 5.5\mu\text{m}$
7384-A200	200	7.8	$\pm 6\mu\text{m}$
7384-A225	225	10	$\pm 6.5\mu\text{m}$
7384-A250	250	10	$\pm 7\mu\text{m}$
7384-A275	275	10	$\pm 7.5\mu\text{m}$
7384-A300	300	10	$\pm 8\mu\text{m}$

55° thread angle

Code	L	Ød	Accuracy
7384-B25	25	7.8	$\pm 2.5\mu\text{m}$
7384-B50	50	7.8	$\pm 3\mu\text{m}$
7384-B75	75	7.8	$\pm 3.5\mu\text{m}$
7384-B100	100	7.8	$\pm 4\mu\text{m}$
7384-B125	125	7.8	$\pm 4.5\mu\text{m}$
7384-B150	150	7.8	$\pm 5\mu\text{m}$
7384-B175	175	7.8	$\pm 5.5\mu\text{m}$
7384-B200	200	7.8	$\pm 6\mu\text{m}$
7384-B225	225	10	$\pm 6.5\mu\text{m}$
7384-B250	250	10	$\pm 7\mu\text{m}$
7384-B275	275	10	$\pm 7.5\mu\text{m}$
7384-B300	300	10	$\pm 8\mu\text{m}$

SCREW THREAD MICROMETERS

NON-ROTATING SPINDLE

6



3281-25A
(measuring tips are optional)



3281-S25
(measuring tips are included)

- Measure pitch diameter of screw threads
- Graduation 0.01mm
- Non-rotating spindle
- Ratchet stop
- Supplied with 60° setting standards (except 0-25mm)
- Optional accessory: 55° setting standards

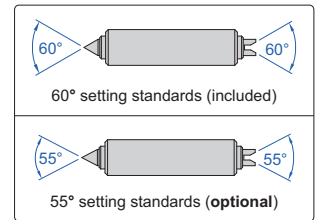
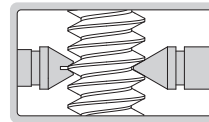

Measuring tips are optional (mm)

Code	Range	L	b	55° setting standard (optional)
3281-25A	0-25mm	42	26	—
3281-50A	25-50mm	67	38	3281-SP1
3281-75A	50-75mm	92	50	3281-SP2
3281-100A	75-100mm	117.6	62	3281-SP3
3281-125A	100-125mm	143	70	3281-SP4
3281-150A	125-150mm	168.2	82	3281-SP5
3281-175A	150-175mm	192	94.5	3281-SP6
3281-200A	175-200mm	217	107	3281-SP7
3281-225A	200-225mm	242	130	3281-SP8
3281-250A	225-250mm	267	142	3281-SP9
3281-275A	250-275mm	291	155	3281-SP10
3281-300A	275-300mm	317	167	3281-SP11

Measuring tips are included (mm)

Code	Range	L	b	Measuring tips (included)	55° setting standard (optional)
3281-S25	0-25mm	42	26	6 pairs of measuring tips: metric and unified thread (60° thread angle) 0.4-0.5mm/64-48TPI, 0.6-0.9mm/44-28TPI, 1-1.75mm/24-14TPI, 2-3mm/13-9TPI, 3.5-5mm/8-5TPI, 5.5-7mm/4.5-3.5TPI	—
3281-S50	25-50mm	67	38		3281-SP1
3281-S75	50-75mm	92	50		3281-SP2
3281-S100	75-100mm	117.6	62		3281-SP3
3281-S125	100-125mm	143	70		3281-SP4
3281-S150	125-150mm	168.2	82		3281-SP5
3281-S175	150-175mm	192	94.5		3281-SP6
3281-S200	175-200mm	217	107		3281-SP7
3281-S225	200-225mm	242	130		3281-SP8
3281-S250	225-250mm	267	142		3281-SP9
3281-S275	250-275mm	291	155		3281-SP10
3281-S300	275-300mm	317	167	3281-SP11	

accuracy of micrometers with tips (mm)

Pitch	Range							
	0-25	25-50	50-75	75-100	100-125	125-200	200-225	225-300
0.4~0.5	±0.01	-	-	-	-	-	-	-
0.6~0.8	±0.01	±0.013	-	-	-	-	-	-
1~1.25	±0.012	±0.015	±0.017	±0.017	-	-	-	-
1.5~2.0	±0.014	±0.017	±0.019	±0.019	±0.020	±0.023	±0.025	±0.028
2.5~3.5	±0.016	±0.019	±0.021	±0.021	±0.023	±0.025	±0.028	±0.031
4.0~7.0	-	±0.021	±0.023	±0.023	±0.025	±0.028	±0.031	±0.033

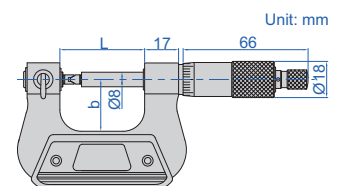

DATA
OUTPUT

NON-ROTATING
SPINDLE

DIGITAL SCREW THREAD MICROMETERS



3581-25A
(measuring tips are optional)



3581-S25
(measuring tips are included)

Measuring tips are optional (mm)

Code	Range	L	b	55° setting standard (optional)
3581-25A	0-25mm/0-1"	42	26	-
3581-50A	25-50mm/1-2"	67	38	3281-SP1
3581-75A	50-75mm/2-3"	92	50	3281-SP2
3581-100A	75-100mm/3-4"	117.6	62	3281-SP3
3581-125A	100-125mm/4-5"	143	70	3281-SP4
3581-150A	125-150mm/5-6"	168.2	82	3281-SP5
3581-175A	150-175mm/6-7"	192	94.5	3281-SP6
3581-200A	175-200mm/7-8"	217	107	3281-SP7
3581-225A	200-225mm/8-9"	242	130	3281-SP8
3581-250A	225-250mm/9-10"	267	142	3281-SP9
3581-275A	250-275mm/10-11"	291	155	3281-SP10
3581-300A	275-300mm/11-12"	317	167	3281-SP11

- Measure pitch diameter of screw threads
- Resolution 0.001mm/0.00005"
- Button function: on/off, set, mm/inch, data transmit
- Data output
- Automatic power off
- Non-rotating spindle
- Ratchet stop
- Supplied with 60° setting standards (except 0-25mm/0-1")
- Optional accessory: 55° setting standards, wireless transmitter code **7315-31** (receiver is needed) page 6, bluetooth transmitter code **7214-31** page 12, data output cable code **7302-31** page 20

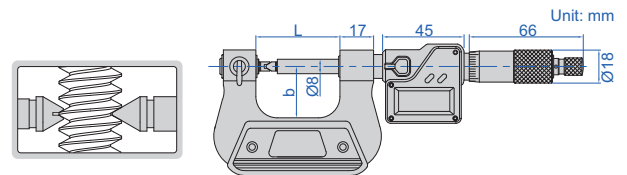

Measuring tips are included (mm)

Code	Range	L	b	Measuring tips (included)	55° setting standard (optional)
3581-S25	0-25mm/0-1"	42	26	6 pairs of measuring tips: metric and unified thread (60° thread angle) 0.4-0.5mm/64-48TPI, 0.6-0.9mm/44-28TPI, 1-1.75mm/24-14TPI, 2-3mm/13-9TPI, 3.5-5mm/8-5TPI, 5.5-7mm/4.5-3.5TPI	-
3581-S50	25-50mm/1-2"	67	38		3281-SP1
3581-S75	50-75mm/2-3"	92	50		3281-SP2
3581-S100	75-100mm/3-4"	117.6	62		3281-SP3
3581-S125	100-125mm/4-5"	143	70		3281-SP4
3581-S150	125-150mm/5-6"	168.2	82		3281-SP5
3581-S175	150-175mm/6-7"	192	94.5		3281-SP6
3581-S200	175-200mm/7-8"	217	107		3281-SP7
3581-S225	200-225mm/8-9"	242	130		3281-SP8
3581-S250	225-250mm/9-10"	267	142		3281-SP9
3581-S275	250-275mm/10-11"	291	155		3281-SP10
3581-S300	275-300mm/11-12"	317	167		3281-SP11

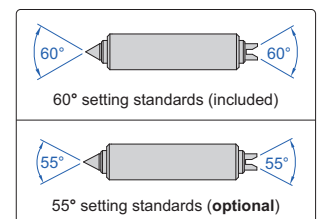

accuracy of micrometers with tips (mm)

Pitch	Range							
	0-25	25-50	50-75	75-100	100-125	125-200	200-225	225-300
0.4~0.5	±0.01	-	-	-	-	-	-	-
0.6~0.8	±0.01	±0.013	-	-	-	-	-	-
1~1.25	±0.012	±0.015	±0.017	±0.017	-	-	-	-
1.5~2.0	±0.014	±0.017	±0.019	±0.019	±0.020	±0.023	±0.025	±0.028
2.5~3.5	±0.016	±0.019	±0.021	±0.021	±0.023	±0.025	±0.028	±0.031
4.0~7.0	-	±0.021	±0.023	±0.023	±0.025	±0.028	±0.031	±0.033

MEASURING TIPS FOR SCREW THREAD MICROMETERS

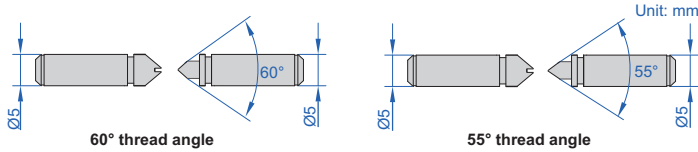

7381-T13

- Supplied in pair
- Suitable for 3281, 3581 series micrometers

Metric and unified thread (60° thread angle)

Code	Pitch
7381-T11	0.4-0.5mm/64-48TPI
7381-T12	0.6-0.9mm/44-28TPI
7381-T13	1-1.75mm/24-14TPI
7381-T14	2-3mm/13-9TPI
7381-T15	3.5-5mm/8-5TPI
7381-T16	5.5-7mm/4.5-3.5TPI
7381-TS	6 pairs/set, including all above tips

Whitworth thread (55° thread angle)

Code	Pitch
7381-T21	60-48TPI
7381-T22	48-40TPI
7381-T23	40-32TPI
7381-T24	32-24TPI
7381-T25	24-18TPI
7381-T26	18-14TPI
7381-T27	14-10TPI
7381-T28	10-7TPI
7381-T29	7-4.5TPI
7381-T210	4.5-3.5TPI
7381-T2S	10 pairs/set, including all above tips

6

EXTERNAL GEAR TOOTH MICROMETERS

INSIZE PLUS
MADE IN EUROPE

**INSPECTION
CERTIFICATE**

ATTENTION: SETTING
STANDARDS ARE NOT INCLUDED

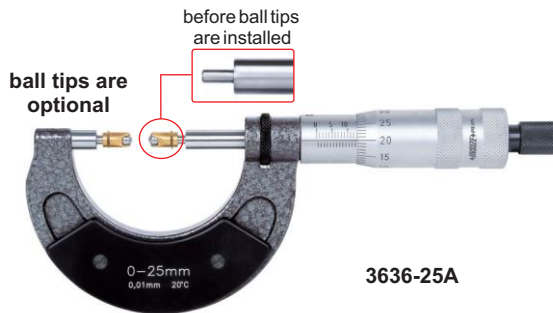

3636-25A

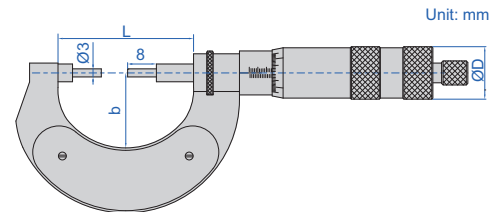

- Meet DIN863-3
- Measure over-pin diameter of gears
- Graduation 0.01mm
- Ratchet stop
- Optional accessory: ball tips (code 7383), setting standards (code 7386)

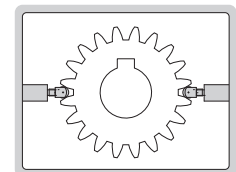

Code	Range	Accuracy	L	b	ØD
3636-25A*	0-25mm	3µm	62	34	20
3636-50A*	25-50mm	3µm	87	46	20
3636-75A*	50-75mm	4µm	112	60	20
3636-100A*	75-100mm	4µm	139	72	20
3636-125A*	100-125mm	5µm	164	85	20
3636-150A*	125-150mm	5µm	190	97	20
3636-175A*	150-175mm	5µm	215	110	20
3636-200A*	175-200mm	5µm	240	122	20

Code	Range	Accuracy	L	b	ØD
3636-225A*	200-225mm	6µm	264	135	20
3636-250A*	225-250mm	6µm	290	148	20
3636-300A*	250-300mm	6µm	325	165	24
3636-350A*	300-350mm	7µm	370	190	24
3636-400A*	350-400mm	7µm	430	220	24
3636-450A*	400-450mm	8µm	475	250	24
3636-500A*	450-500mm	8µm	530	273	24
3636-550A*	500-550mm	9µm	570	291	24
3636-600A*	550-600mm	9µm	630	323	24

*Supplied with manufacturer inspection certificate

BALL TIPS DIAMETER
SØD CAN BE CUSTOMIZED

BALL TIPS FOR GEAR TOOTH MICROMETERS

INSIZE PLUS
MADE IN EUROPE

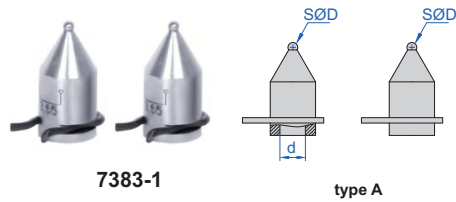

7383-1

type A

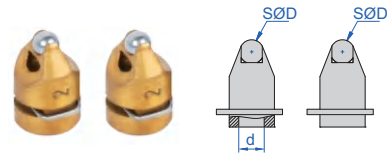

7383-2

type B

- Supplied in pair
- Made of hardened steel
- Suitable for 3636, 3638, 3678 series micrometers

Code	Ball dia. (SØD)	d	Accuracy	Type
7383-1	SØ1mm	Ø3mm	±1µm	A
7383-1D5	SØ1.5mm	Ø3mm	±1µm	B
7383-1D75	SØ1.75mm	Ø3mm	±1µm	B
7383-2	SØ2mm	Ø3mm	±1µm	B
7383-2D25	SØ2.25mm	Ø3mm	±1µm	B
7383-2D5	SØ2.5mm	Ø3mm	±1µm	B
7383-3	SØ3mm	Ø3mm	±1µm	B
7383-3D5	SØ3.5mm	Ø3mm	±1µm	B
7383-4	SØ4mm	Ø3mm	±1µm	B
7383-4D5	SØ4.5mm	Ø3mm	±1µm	B
7383-5	SØ5mm	Ø3mm	±1µm	B
7383-5D5	SØ5.5mm	Ø3mm	±1µm	B
7383-6	SØ6mm	Ø3mm	±1µm	B

Code	Ball dia. (SØD)	d	Accuracy	Type
7383-6D5	SØ6.5mm	Ø3mm	±1µm	B
7383-7	SØ7mm	Ø3mm	±1µm	B
7383-7D5	SØ7.5mm	Ø3mm	±1µm	B
7383-8	SØ8mm	Ø3mm	±1µm	B
7383-9	SØ9mm	Ø3mm	±1µm	B
7383-10	SØ10mm	Ø3mm	±1µm	B
7383-10D5	SØ10.5mm	Ø3mm	±1.5µm	B
7383-11	SØ11mm	Ø3mm	±1.5µm	B
7383-12	SØ12mm	Ø3mm	±1.5µm	B
7383-13	SØ13mm	Ø3mm	±1.5µm	B
7383-14	SØ14mm	Ø3mm	±1.5µm	B
7383-15	SØ15mm	Ø3mm	±1.5µm	B
7383-16	SØ16mm	Ø3mm	±1.5µm	B

GEAR TOOTH MICROMETERS

- Meet DIN863-3
- Measure over-pin diameter of gears
- Graduation 0.01mm
- Ratchet stop
- Supplied with setting standards (except 0-25mm)
- Optional accessory: ball tips (code 7391)

ball tips are optional



3291-25

Code	Range	Accuracy	L	b
3291-25	0-25mm	4µm	67	38
3291-50	25-50mm	4µm	92.4	50
3291-75	50-75mm	5µm	117.6	62
3291-100	75-100mm	5µm	143	70
3291-125	100-125mm	6µm	168.2	82
3291-150	125-150mm	6µm	192	94.5
3291-175	150-175mm	7µm	217	107
3291-200	175-200mm	7µm	242	130
3291-225	200-225mm	8µm	267	142.5
3291-250	225-250mm	8µm	292	155
3291-275	250-275mm	9µm	317	167.5

(mm)

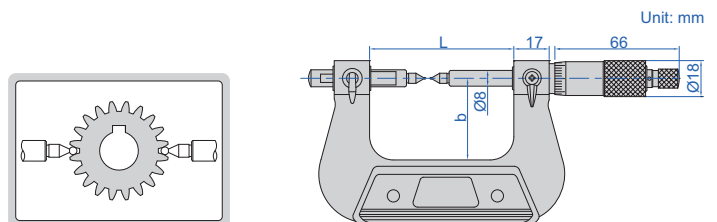

DIGITAL GEAR TOOTH MICROMETERS

IP65
WATERPROOF

DATA
OUTPUT

ball tips are optional



3591-25A

- Measure over-pin diameter of gears
- Resolution 0.001mm/0.0005"
- IP65 dust/waterproof
- Button function: on/off, set, mm/inch, data transmit
- Data output
- Automatic power off
- Ratchet stop
- Supplied with setting standards (except 0-25mm/0-1")
- Optional accessory: ball tips (code 7391), wireless transmitter code 7315-31 (receiver is needed) page 6, bluetooth transmitter code 7214-31 page 12, data output cable code 7302-31 page 20

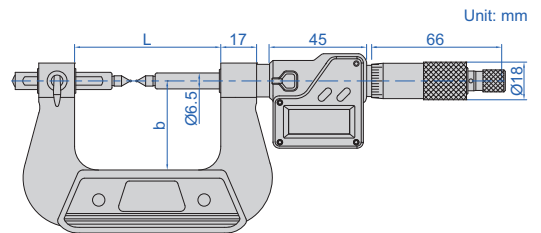

Code	Range	Accuracy	L	b
3591-25A	0-25mm/0-1"	±4µm	67	38
3591-50A	25-50mm/1-2"	±4µm	92.4	50
3591-75A	50-75mm/2-3"	±5µm	117.6	62
3591-100A	75-100mm/3-4"	±5µm	143	70
3591-125A	100-125mm/4-5"	±6µm	168.2	82
3591-150A	125-150mm/5-6"	±6µm	192	94.5
3591-175A	150-175mm/6-7"	±7µm	217	107
3591-200A	175-200mm/7-8"	±7µm	242	130
3591-225A	200-225mm/8-9"	±8µm	267	142.5
3591-250A	225-250mm/9-10"	±8µm	292	155
3591-275A	250-275mm/10-11"	±9µm	317	167.5

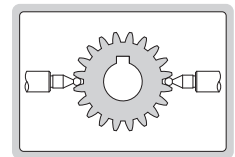

BALL TIPS FOR GEAR TOOTH MICROMETERS

BALL TIPS DIAMETER SØD CAN BE CUSTOMIZED WITH SIZES BETWEEN 1.50-6.00MM

- Supplied in pair
- Suitable for 3291, 3591 series micrometers



7391-T5

Code	Ball dia. (D)
7391-T2	SØ1.5mm
7391-T3	SØ2.0mm
7391-T4	SØ2.5mm
7391-T5	SØ3.0mm

Code	Ball dia. (D)
7391-T6	SØ3.5mm
7391-T7	SØ4.0mm
7391-T8	SØ4.5mm
7391-T9	SØ5.0mm
7391-T10	SØ6.0mm



ATTENTION: SETTING STANDARDS ARE NOT INCLUDED



POINT MICROMETERS

INSIZE PLUS
MADE IN EUROPE

(mm)

Code	Range	Accuracy	L	b
3659-25A*	0-25mm	4μm	62	34
3659-50A*	25-50mm	4μm	87	46
3659-75A*	50-75mm	5μm	112	60
3659-100A*	75-100mm	5μm	139	72
3659-125A*	100-125mm	6μm	164	85
3659-150A*	125-150mm	6μm	190	97
3659-175A*	150-175mm	7μm	215	110
3659-200A*	175-200mm	7μm	240	122
3659-225A*	200-225mm	8μm	264	135
3659-250A*	225-250mm	8μm	290	148

* Supplied with manufacturer inspection certificate



3659-25A

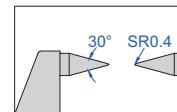
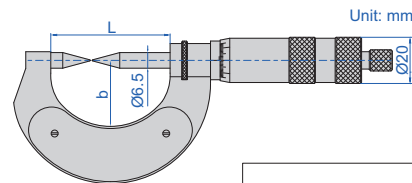

- Measure the web thickness of drills, small grooves and keyways
- Graduation: 0.01mm
- Ratchet stop
- Carbide tips
- Optional accessory: setting standards (code 7386)

POINT MICROMETERS

- Measure the web thickness of drills, small grooves and keyways
- Graduation 0.01mm
- Ratchet stop
- Carbide tips
- Supplied with setting standards (except 0-25mm)

(mm)

Code	Range	Type	Accuracy	L	b
3230-25A	0-25mm	A	4μm	57	32
3230-50A	25-50mm	A	4μm	82	44.5
3230-75A	50-75mm	A	5μm	107	57
3230-100A	75-100mm	A	5μm	132.6	69.5
3230-25BA	0-25mm	B	4μm	57	32
3230-50BA	25-50mm	B	4μm	82	44.5
3230-75BA	50-75mm	B	5μm	107	57
3230-100BA	75-100mm	B	5μm	132.6	69.5



3230-25A

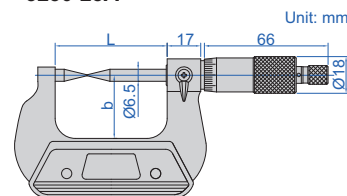
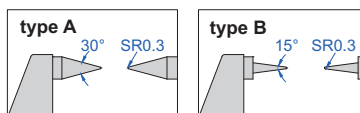

DIGITAL POINT MICROMETERS

- Measure the web thickness of drills, small grooves and keyways
- Resolution 0.001mm/0.00005"
- IP65 dust/waterproof
- Button function: on/off, set, mm/inch, data transmit
- Data output
- Automatic power off
- Ratchet stop
- Carbide tips
- Supplied with setting standards (except 0-25mm/0-1")
- Optional accessory:
 - wireless transmitter code 7315-31 (receiver is needed) page 6,
 - bluetooth transmitter code 7214-31 page 12,
 - data output cable code 7302-31 page 20

DATA OUTPUT

IP65 WATERPROOF



3530-25A

(mm)

Code	Range	Type	Accuracy	L	b
3530-25A	0-25mm/0-1"	A	±4μm	57	32
3530-50A	25-50mm/1-2"	A	±4μm	82	44.5
3530-75A	50-75mm/2-3"	A	±5μm	107	57
3530-100A	75-100mm/3-4"	A	±5μm	132.6	69.5
3530-25BA	0-25mm/0-1"	B	±4μm	57	32
3530-50BA	25-50mm/1-2"	B	±4μm	82	44.5
3530-75BA	50-75mm/2-3"	B	±5μm	107	57
3530-100BA	75-100mm/3-4"	B	±5μm	132.6	69.5

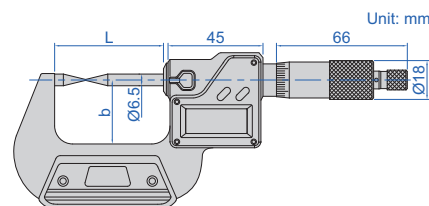
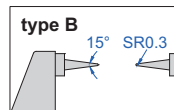
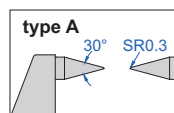

DIGITAL POINT MICROMETERS/SNAP GAUGES

ONE TURN OF SLEEVE MAKES 5MM SPINDLE FEED, PRESS THE FORK, THE SPINDLE RETRACTS 3MM

ABSOLUTE ENCODER, THE ORIGINAL DATA REMAINS AFTER POWER OFF

MEASUREMENT ACCURACY IS NOT AFFECTED BY THE USE OF SLEEVE

NON-ROTATING SPINDLE

DATA OUTPUT

ATTENTION: RECHARGEABLE BATTERY, FOR 24 HOURS CONTINUOUS WORKING

IP65 WATERPROOF

INSPECTION CERTIFICATE



VIDEO

6



3354-25

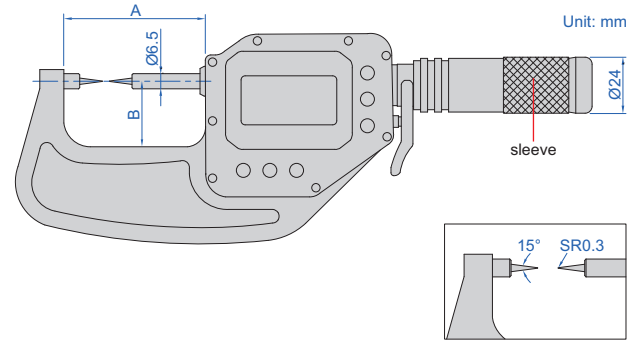

- Measure the web thickness of drills, small grooves and keyways
- Absolute encoder, the original data remains after power off
- Adjustable resolution: 0.0002mm/0.00001"
0.001mm/0.00005"
0.01mm/0.0005"
- One turn of sleeve makes 5mm spindle feed
- Measurement accuracy is not affected by the use of sleeve
- Press the fork, the spindle retracts 3mm
- Linear ball bearings for ten million times use
- Carbide spindle and anvil
- Measuring force 7-10N
Customizable measuring force range 2-12N
Attention: small measuring force will reduce the dustproof and waterproof level
- Button function: data output, tolerance, data preset, data hold, measuring direction change, max./min./TIR, power off time, on/off, zero, mm/inch, adjust resolution
- Supplied with gauge blocks for zero setting (except 0-25mm/0-1")
- Power: rechargeable battery, for 24 hours continuous working

alarm when over tolerance

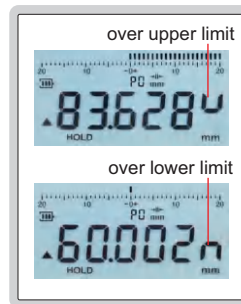

wireless receiver 2134-R1, 2134-R2 (optional)



With data interface

Optional accessory:
wireless transmitter code 7315-3350 (receiver is needed) page 7
data output cable (keyboard format) code 7302-3350 page 21

Code	Range	Accuracy	Repeatability	A	B
3354-25*	0-25mm/0-1"	2µm	1µm	63mm	25mm
3354-50*	25-50mm/1-2"	2µm	1µm	88mm	42mm
3354-75*	50-75mm/2-3"	2µm	1µm	113mm	56mm

Built-in wireless

Optional accessory:
wireless receiver (keyboard format, connect up to 15 digital indicators), code 2134-R1
wireless receiver (serial port format, connect up to 15 digital indicators), code 2134-R2

Code	Range	Accuracy	Repeatability	A	B
3354-25WL*	0-25mm/0-1"	2µm	1µm	63mm	25mm
3354-50WL*	25-50mm/1-2"	2µm	1µm	88mm	42mm
3354-75WL*	50-75mm/2-3"	2µm	1µm	113mm	56mm

*Supplied with manufacturer inspection certificate

GEAR ROOT DIAMETER MICROMETERS

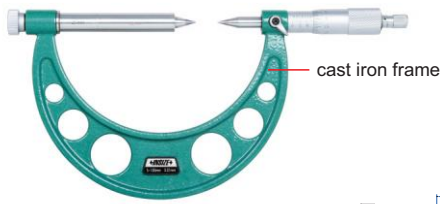

3297-100

- Measure diameter of gear root circle
- Graduation 0.01mm
- Ratchet stop
- Meet DIN863-3
- Carbide measuring faces
- Supplied with setting standards

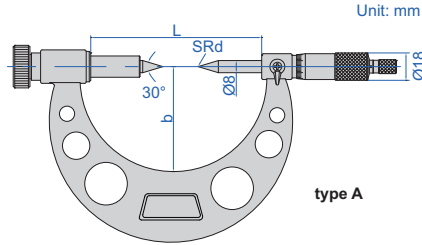

type A

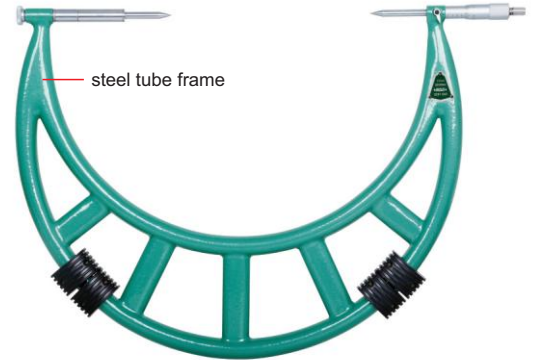

3297-300

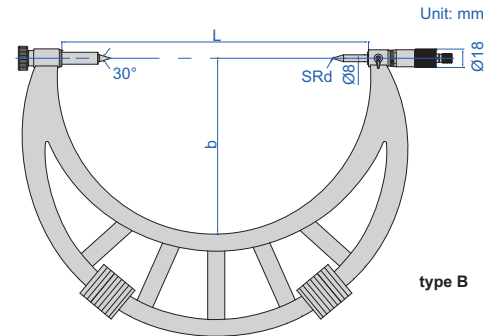

type B

Code	Range	Type	Accuracy	L	b	SRd
3297-100	5-100mm	A	5μm	137	72	0.4
3297-200	100-200mm	A	7μm	237	129	0.5
3297-300	200-300mm	B	9μm	414	225	0.7
3297-400	300-400mm	B	11μm	514	275	0.7
3297-500	400-500mm	B	13μm	614	325	0.7
3297-600	500-600mm	B	15μm	714	375	0.7
3297-700	600-700mm	B	16μm	814	425	0.7
3297-800	700-800mm	B	18μm	914	475	0.7
3297-900	800-900mm	B	20μm	1014	525	0.7

IP65
WATERPROOF

DATA
OUTPUT

DIGITAL GEAR ROOT DIAMETER MICROMETERS

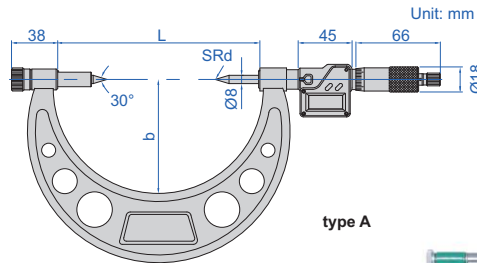

type A



3597-100

- Measure diameter of gear root circle
- Resolution 0.001mm/0.0001" (resolution of 3597-100 and 3597-200 is 0.001mm/0.00005")
- IP65 dust/waterproof
- Button function: on/off, set, mm/inch, data transmit
- Data output
- Automatic power off
- Ratchet stop
- Carbide measuring faces
- Supplied with setting standards
- Optional accessory:
 - wireless transmitter code **7315-31** (receiver is needed) page 6,
 - bluetooth transmitter code **7214-31** page 12,
 - data output cable code **7302-31** page 20



3597-300

(mm)

Code	Range	Type	Accuracy	L	b	SRd
3597-100	5-100mm	A	3μm	137	72	0.4
3597-200	100-200mm	A	4μm	237	129	0.5
3597-300	200-300mm	B	5μm	414	225	0.7
3597-400	300-400mm	B	6μm	514	275	0.7
3597-500	400-500mm	B	7μm	614	325	0.7
3597-600	500-600mm	B	8μm	714	375	0.7
3597-700	600-700mm	B	8μm	814	425	0.7
3597-800	700-800mm	B	9μm	914	475	0.7
3597-900	800-900mm	B	10μm	1014	525	0.7

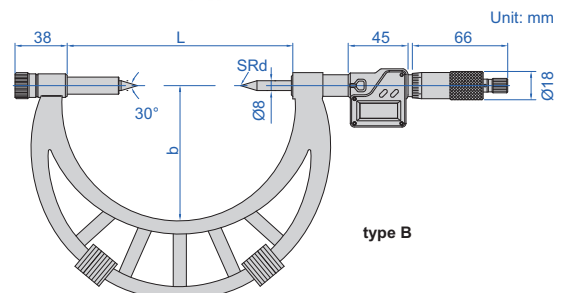

type B

BLADE MICROMETERS

INSIZE PLUS
MADE IN EUROPE

INSPECTION
CERTIFICATE

ATTENTION: SETTING
STANDARDS ARE NOT INCLUDED

6



3650-25A

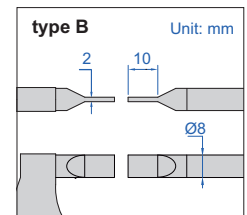
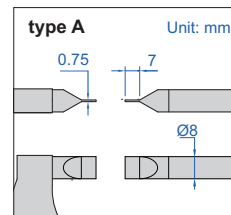
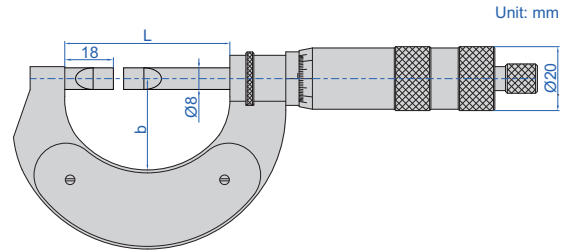
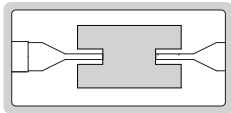

- Meet DIN863-3
- Graduation 0.01mm
- Force: 5-10N
- Optional accessory: setting standards (code 7386)

(mm)

Code	Range	Type	Accuracy	L	b
3650-25A*	0-25mm	A	4µm	62	34
3650-50A*	25-50mm	A	4µm	87	46
3650-75A*	50-75mm	B	5µm	112	60
3650-100A*	75-100mm	B	5µm	139	72
3650-125A*	100-125mm	B	6µm	164	85
3650-150A*	125-150mm	B	6µm	190	97
3650-175A*	150-175mm	B	7µm	215	110
3650-200A*	175-200mm	B	7µm	240	122
3650-225A*	200-225mm	B	8µm	264	135
3650-250A*	225-250mm	B	8µm	290	148
3650-275A*	250-275mm	B	9µm	315	160
3650-300A*	275-300mm	B	9µm	340	174

*Supplied with manufacturer inspection certificate

NON-ROTATING SPINDLE

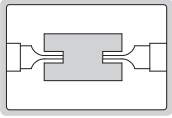

- Meet DIN863-3
- Measure the groove diameter of shafts and keyways
- Graduation 0.01mm
- Non-rotating spindle
- Ratchet stop
- Supplied with setting standards (except 0-25mm)



3232-25A

BLADE MICROMETERS

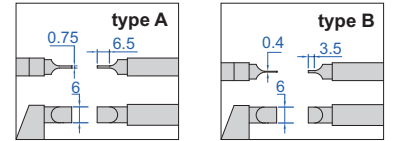
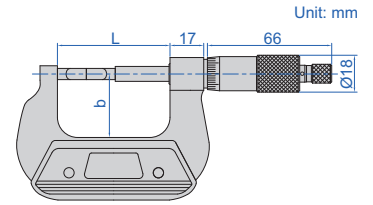

Type A		(mm)		
Code	Range	Accuracy	L	b
3232-25A	0-25mm	4µm	57	32
3232-50A	25-50mm	4µm	82	44.5
3232-75A	50-75mm	5µm	107	57
3232-100A	75-100mm	5µm	132.6	69.5
3232-125A	100-125mm	6µm	158	82
3232-150A	125-150mm	6µm	183.4	94.5
3232-175A	150-175mm	7µm	208.8	107
3232-200A	175-200mm	7µm	234.2	129.6
3232-225A	200-225mm	8µm	259.6	142.3
3232-250A	225-250mm	8µm	285	155
3232-275A	250-275mm	9µm	310.4	167.7
3232-300A	275-300mm	9µm	336.5	177.8

Type B		(mm)		
Code	Range	Accuracy	L	b
3232-25BA	0-25mm	4µm	57	32
3232-50BA	25-50mm	4µm	82	44.5
3232-75BA	50-75mm	5µm	107	57
3232-100BA	75-100mm	5µm	132.6	69.5
3232-125BA	100-125mm	6µm	158	82
3232-150BA	125-150mm	6µm	183.4	94.5
3232-175BA	150-175mm	7µm	208.8	107
3232-200BA	175-200mm	7µm	234.2	129.6
3232-225BA	200-225mm	8µm	259.6	142.3
3232-250BA	225-250mm	8µm	285	155
3232-275BA	250-275mm	9µm	310.4	167.7
3232-300BA	275-300mm	9µm	336.5	177.8

DIGITAL BLADE MICROMETERS

- Measure the groove diameter of shafts and keyways
- Resolution 0.001mm/0.00005"
- Non-rotating spindle
- Button function: on/off, set, mm/inch, data transmit
- Data output
- Automatic power off
- Ratchet stop
- Supplied with setting standards (except 0-25mm/0-1")
- Optional accessory: wireless transmitter code **7315-31** (receiver is needed) page 6, bluetooth transmitter code **7214-31** page 12, data output cable code **7302-31** page 20



3532-25A

DATA OUTPUT

NON-ROTATING SPINDLE

(mm)					
Code	Range	Type	Accuracy	L	b
3532-25A	0-25mm/0-1"	A	±4µm	57	32
3532-50A	25-50mm/1-2"	A	±4µm	82	44.5
3532-75A	50-75mm/2-3"	A	±5µm	107	57
3532-100A	75-100mm/3-4"	A	±5µm	132.6	69.5
3532-125A	100-125mm/4-5"	A	±6µm	158	82
3532-150A	125-150mm/5-6"	A	±6µm	183.4	94.5
3532-175A	150-175mm/6-7"	A	±7µm	208.8	107
3532-25BA	0-25mm/0-1"	B	±4µm	57	32
3532-50BA	25-50mm/1-2"	B	±4µm	82	44.5
3532-75BA	50-75mm/2-3"	B	±5µm	107	57
3532-100BA	75-100mm/3-4"	B	±5µm	132.6	69.5
3532-125BA	100-125mm/4-5"	B	±6µm	158	82
3532-150BA	125-150mm/5-6"	B	±6µm	183.4	94.5
3532-175BA	150-175mm/6-7"	B	±7µm	208.8	107

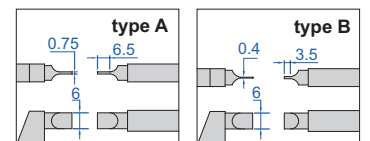
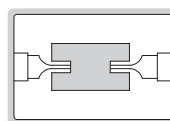
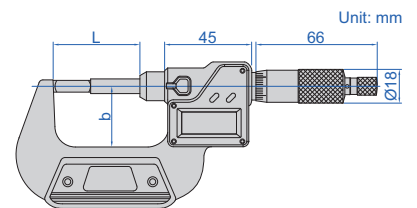

DIGITAL BLADE MICROMETERS/SNAP GAUGES

ATTENTION: RECHARGEABLE BATTERY, FOR 24 HOURS CONTINUOUS WORKING

MEASUREMENT ACCURACY IS NOT AFFECTED BY THE USE OF SLEEVE

IP65
WATERPROOF

DATA OUTPUT

ABSOLUTE ENCODER, THE ORIGINAL DATA REMAINS AFTER POWER OFF

NON-ROTATING SPINDLE

ONE TURN OF SLEEVE MAKES 5MM SPINDLE FEED, PRESS THE FORK, THE SPINDLE RETRACTS 3MM



3352-25A



VIDEO

INSPECTION CERTIFICATE

6

- Measure the groove diameter of shafts and keyways
- Absolute encoder, the original data remains after power off
- Adjustable resolution: 0.0002mm/0.00001"
0.001mm/0.00005"
0.01mm/0.0005"
- One turn of sleeve makes 5mm spindle feed
- Measurement accuracy is not affected by the use of sleeve
- Press the fork, the spindle retracts 3mm
- Linear ball bearings for ten million times use
- Carbide spindle and anvil
- Measuring force 7-10N
Customizable measuring force range 2-12N
Attention: small measuring force will reduce the dustproof and waterproof level
- Button function: data output, tolerance, data preset, data hold, measuring direction change, max./min./TIR, power off time, on/off, zero, mm/inch, adjust resolution
- Supplied with gauge blocks for zero setting (except 0-25mm/0-1")
- Power: rechargeable battery, for 24 hours continuous working

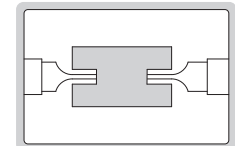
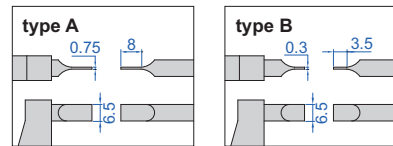
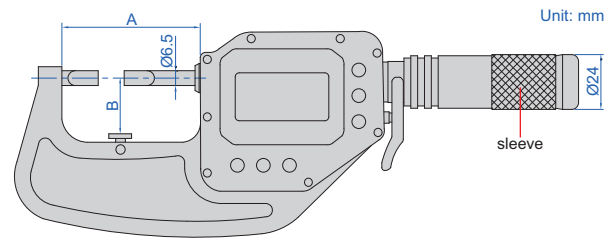

With data interface

Optional accessory:
wireless transmitter code **7315-3350** (receiver is needed) page 7
data output cable (keyboard format) code **7302-3350** page 21

Code	Range	Type	Accuracy	Repeatability	A	B
3352-25A*	0-25mm/0-1"	A	2µm	1µm	63mm	25mm
3352-50A*	25-50mm/1-2"	A	2µm	1µm	88mm	42mm
3352-75A*	50-75mm/2-3"	A	2µm	1µm	113mm	56mm
3352-25B*	0-25mm/0-1"	B	2µm	1µm	63mm	25mm
3352-50B*	25-50mm/1-2"	B	2µm	1µm	88mm	42mm
3352-75B*	50-75mm/2-3"	B	2µm	1µm	113mm	56mm

Built-in wireless

Optional accessory:
wireless receiver (keyboard format, connect up to 15 digital indicators), code **2134-R1**
wireless receiver (serial port format, connect up to 15 digital indicators), code **2134-R2**

Code	Range	Type	Accuracy	Repeatability	A	B
3352-25AWL*	0-25mm/0-1"	A	2µm	1µm	63mm	25mm
3352-50AWL*	25-50mm/1-2"	A	2µm	1µm	88mm	42mm
3352-75AWL*	50-75mm/2-3"	A	2µm	1µm	113mm	56mm
3352-25BWL*	0-25mm/0-1"	B	2µm	1µm	63mm	25mm
3352-50BWL*	25-50mm/1-2"	B	2µm	1µm	88mm	42mm
3352-75BWL*	50-75mm/2-3"	B	2µm	1µm	113mm	56mm

*Supplied with manufacturer inspection certificate

alarm when over tolerance

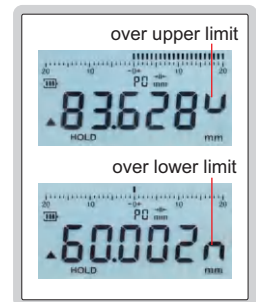

wireless receiver 2134-R1, 2134-R2 (optional)



RELATIVE PRODUCT: DIGITAL CRIMP HEIGHT CALIPER (CODE 1165-150A)

- Measure the height of crimp contact
- Graduation 0.01mm
- Ratchet stop
- Supplied with setting standards (except 0-25mm)

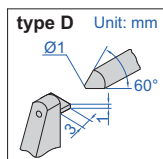
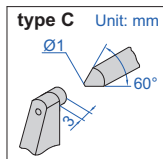
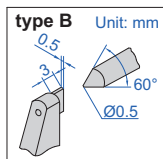

CRIMP HEIGHT MICROMETERS



3266-25BA

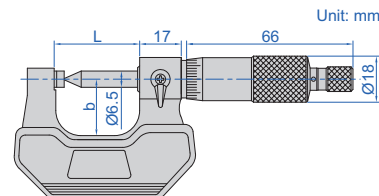

(mm)

Code	Range	Type	Accuracy	L	b
3266-25BA	0-25mm	B	4µm	34	24
3266-25CA	0-25mm	C	4µm	34	24
3266-50CA	25-50mm	C	4µm	59	32
3266-75CA	50-75mm	C	5µm	85	45
3266-100CA	75-100mm	C	5µm	110	57
3266-25DA	0-25mm	D	4µm	34	24

DATA OUTPUT

IP65
WATERPROOF

DIGITAL CRIMP HEIGHT MICROMETERS

RELATIVE PRODUCT: DIGITAL CRIMP HEIGHT CALIPER (CODE 1165-150A)

- Measure the height of crimp contact
- Resolution 0.001mm/0.00005"
- IP65 dust/waterproof
- Button function: on/off, set, mm/inch, data transmit
- Data output
- Automatic power off
- Ratchet stop
- Supplied with setting standards (except 0-25mm/0-1")
- Optional accessory: wireless transmitter code **7315-31** (receiver is needed) page 6, bluetooth transmitter code **7214-31** page 12, data output cable code **7302-31** page 20



3566-25BA

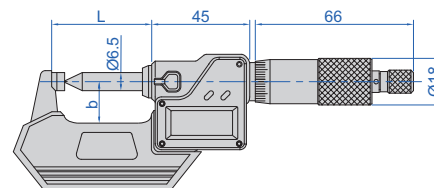

(mm)

Code	Range	Type	Accuracy	L	b
3566-25BA	0-25mm/0-1"	B	±4µm	34.5	25
3566-25CA	0-25mm/0-1"	C	±4µm	34.5	25
3566-50CA	25-50mm/1-2"	C	±4µm	59.5	32
3566-75CA	50-75mm/2-3"	C	±5µm	84.5	44.5
3566-100CA	75-100mm/3-4"	C	±5µm	109.5	57
3566-25DA	0-25mm/0-1"	D	±4µm	34.5	25

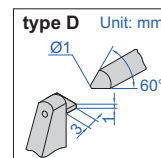
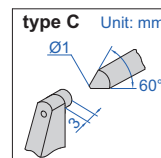
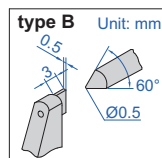

INSPECTION CERTIFICATE

ATTENTION: SETTING STANDARDS ARE NOT INCLUDED

SPLINE MICROMETERS

INSIZE PLUS
MADE IN EUROPE

(mm)

Code	Range	Accuracy	L	b
3658-25 *	0-25mm	4µm	62	34
3658-50 *	25-50mm	4µm	87	46
3658-75 *	50-75mm	5µm	112	60
3658-100 *	75-100mm	5µm	139	72
3658-125 *	100-125mm	6µm	164	85
3658-150 *	125-150mm	6µm	190	97
3658-175 *	150-175mm	7µm	215	110
3658-200 *	175-200mm	7µm	240	122
3658-225 *	200-225mm	8µm	264	135
3658-250 *	225-250mm	8µm	290	148

* Supplied with manufacturer inspection certificate



3658-25

- Meet DIN863-3
- Measure splined shafts, slots and keyways
- Graduation 0.01mm
- Ratchet stop
- Carbide measuring faces
- Optional accessory: setting standards (code **7386**)

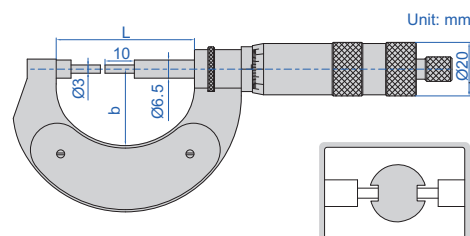

SPLINE MICROMETERS

- Meet DIN863-3
- Measure splined shafts, slots and keyways
- Graduation 0.01mm
- Ratchet stop
- Carbide measuring faces
- Supplied with setting standards (except 0-25mm)



3233-25BA

(mm)					
Code	Range	Type	Accuracy	L	b
3233-25A	0-25mm	A	4μm	57	32
3233-50A	25-50mm	A	4μm	82	44.5
3233-75A	50-75mm	A	5μm	107	57
3233-100A	75-100mm	A	5μm	132.6	69.5
3233-125A	100-125mm	A	6μm	158	82
3233-150A	125-150mm	A	6μm	183.4	94.5
3233-175A	150-175mm	A	7μm	208.8	107
3233-25BA	0-25mm	B	4μm	57	32
3233-50BA	25-50mm	B	4μm	82	44.5
3233-75BA	50-75mm	B	5μm	107	57
3233-100BA	75-100mm	B	5μm	132.6	69.5
3233-125BA	100-125mm	B	6μm	158	82
3233-150BA	125-150mm	B	6μm	183.4	94.5
3233-175BA	150-175mm	B	7μm	208.8	107

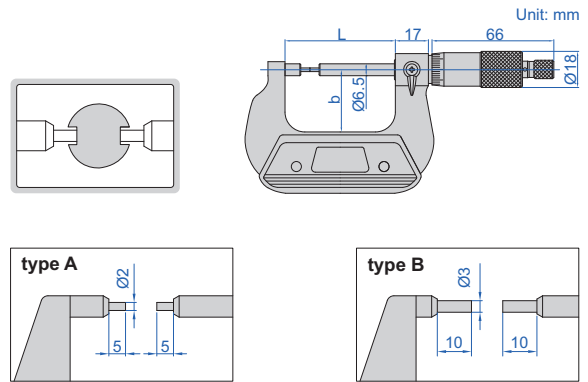

6

DIGITAL SPLINE MICROMETERS

IP65
WATERPROOF

DATA
OUTPUT

- Measure splined shafts, slots and keyways
- Resolution 0.001mm/0.00005"
- IP65 dust/waterproof
- Button function: on/off, set, mm/inch, data transmit
- Data output
- Automatic power off
- Ratchet stop
- Carbide measuring faces
- Supplied with setting standards (except 0-25mm/0-1")
- Optional accessory:
wireless transmitter code **7315-31** (receiver is needed) page 6,
bluetooth transmitter code **7214-31** page 12,
data output cable code **7302-31** page 20



3533-25BA

(mm)					
Code	Range	Type	Accuracy	L	b
3533-25A	0-25mm/0-1"	A	±4μm	57	32
3533-50A	25-50mm/1-2"	A	±4μm	82	44.5
3533-75A	50-75mm/2-3"	A	±5μm	107	57
3533-100A	75-100mm/3-4"	A	±5μm	132.6	69.5
3533-125A	100-125mm/4-5"	A	±6μm	158	82
3533-150A	125-150mm/5-6"	A	±6μm	183.4	94.5
3533-175A	150-175mm/6-7"	A	±7μm	208.8	107
3533-25BA	0-25mm/0-1"	B	±4μm	57	32
3533-50BA	25-50mm/1-2"	B	±4μm	82	44.5
3533-75BA	50-75mm/2-3"	B	±5μm	107	57
3533-100BA	75-100mm/3-4"	B	±5μm	132.6	69.5
3533-125BA	100-125mm/4-5"	B	±6μm	158	82
3533-150BA	125-150mm/5-6"	B	±6μm	183.4	94.5
3533-175BA	150-175mm/6-7"	B	±7μm	208.8	107

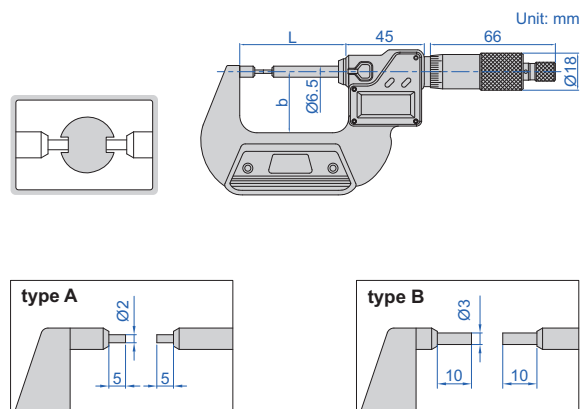

DIGITAL SPLINE MICROMETERS/SNAP GAUGES

ONE TURN OF SLEEVE MAKES 5MM SPINDLE FEED, PRESS THE FORK, THE SPINDLE RETRACTS 3MM

MEASUREMENT ACCURACY IS NOT AFFECTED BY THE USE OF SLEEVE

NON-ROTATING SPINDLE

ABSOLUTE ENCODER, THE ORIGINAL DATA REMAINS AFTER POWER OFF

IP65 WATERPROOF

ATTENTION: RECHARGEABLE BATTERY, FOR 24 HOURS CONTINUOUS WORKING

DATA OUTPUT

INSPECTION CERTIFICATE

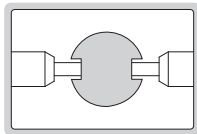

3356-25

- Measure splined shafts, slots and keyways
- Absolute encoder, the original data remains after power off
- Adjustable resolution: 0.0002mm/0.00001"
0.001mm/0.00005"
0.01mm/0.0005"
- One turn of sleeve makes 5mm spindle feed
- Measurement accuracy is not affected by the use of sleeve
- Press the fork, the spindle retracts 3mm
- Linear ball bearings for ten million times use
- Carbide spindle and anvil
- Measuring force 7-10N
Customizable measuring force range 2-12N
Attention: small measuring force will reduce the dustproof and waterproof level
- Button function: data output, tolerance, data preset, data hold, measuring direction change, max./min./TIR, power off time, on/off, zero, mm/inch, adjust resolution
- Supplied with gauge blocks for zero setting (except 0-25mm/0-1")
- Power: rechargeable battery, for 24 hours continuous working

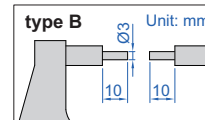
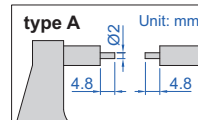
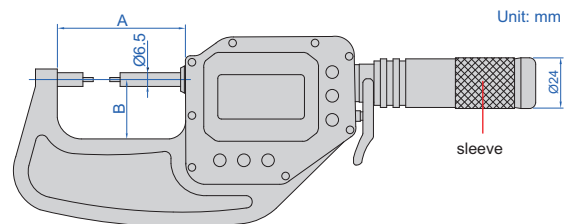

With data interface

Optional accessory:

wireless transmitter code **7315-3350** (receiver is needed) page 7
data output cable (keyboard format) code **7302-3350** page 21

Code	Range	Accuracy	Type	Repeatability	A	B
3356-25 *	0-25mm/0-1"	2µm	A	1µm	63mm	25mm
3356-50 *	25-50mm/1-2"	2µm	A	1µm	88mm	42mm
3356-75 *	50-75mm/2-3"	2µm	A	1µm	113mm	56mm
3356-25B *	0-25mm/0-1"	2µm	B	1µm	63mm	25mm
3356-50B *	25-50mm/1-2"	2µm	B	1µm	88mm	42mm
3356-75B *	50-75mm/2-3"	2µm	B	1µm	113mm	56mm

alarm when over tolerance

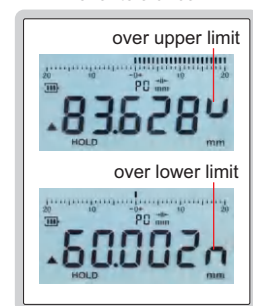

Built-in wireless

Optional accessory:

wireless receiver (keyboard format, connect up to 15 digital indicators), code **2134-R1**
wireless receiver (serial port format, connect up to 15 digital indicators), code **2134-R2**

Code	Range	Accuracy	Type	Repeatability	A	B
3356-25WL *	0-25mm/0-1"	2µm	A	1µm	63mm	25mm
3356-50WL *	25-50mm/1-2"	2µm	A	1µm	88mm	42mm
3356-75WL *	50-75mm/2-3"	2µm	A	1µm	113mm	56mm
3356-25BWL *	0-25mm/0-1"	2µm	B	1µm	63mm	25mm
3356-50BWL *	25-50mm/1-2"	2µm	B	1µm	88mm	42mm
3356-75BWL *	50-75mm/2-3"	2µm	B	1µm	113mm	56mm

wireless receiver
2134-R1, 2134-R2 (optional)



* Supplied with manufacturer inspection certificate

CYLINDRICAL ANVIL TUBE MICROMETERS

- Measure wall thickness of tubes
- Graduation 0.01mm
- Ratchet stop
- Carbide spindle tip
- Supplied with setting standards (except 0-25mm)



3261-25A

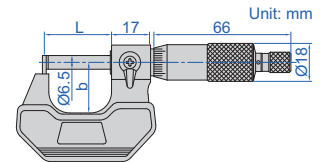
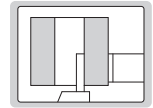

(mm)					
Code	Range	Type	Accuracy	L	b
3261-25A	0-25mm	A	6µm	36	25
3261-50A	25-50mm	A	6µm	61	32
3261-25BA	0-25mm	B	6µm	36	25
3261-50BA	25-50mm	B	6µm	61	32
3261-25CA	0-25mm	C	6µm	36	25
3261-50CA	25-50mm	C	6µm	61	32
3261-25DA	0-25mm	D	6µm	36	25
3261-50DA	25-50mm	D	6µm	61	32
3261-25EA	0-25mm	E	6µm	36	25
3261-50EA	25-50mm	E	6µm	61	32
3261-25FA	0-25mm	F	6µm	36	25
3261-50FA	25-50mm	F	6µm	61	32

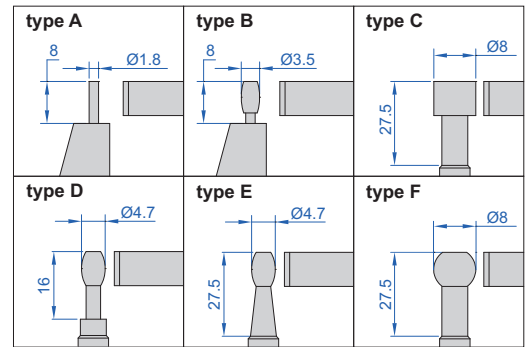

DIGITAL CYLINDRICAL ANVIL TUBE MICROMETERS

IP65
WATERPROOF

DATA
OUTPUT

- Measure wall thickness of tubes
- Resolution 0.001mm/0.00005"
- IP65 dust/waterproof
- Button function: on/off, set, mm/inch, data transmit
- Data output
- Automatic power off
- Ratchet stop
- Carbide spindle tip
- Supplied with setting standards (except 0-25mm/0-1")
- Optional accessory:
 - wireless transmitter code 7315-31 (receiver is needed) page 6,
 - bluetooth transmitter code 7214-31 page 12,
 - data output cable code 7302-31 page 20



3561-25A

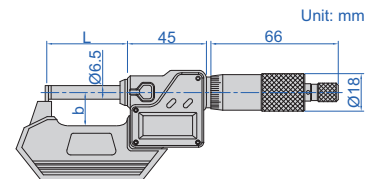
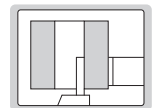

(mm)					
Code	Range	Type	Accuracy	L	b
3561-25A	0-25mm/0-1"	A	±6µm	36	25
3561-50A	25-50mm/1-2"	A	±6µm	61	32
3561-25BA	0-25mm/0-1"	B	±6µm	36	25
3561-50BA	25-50mm/1-2"	B	±6µm	61	32
3561-25CA	0-25mm/0-1"	C	±6µm	36	25
3561-50CA	25-50mm/1-2"	C	±6µm	61	32
3561-25DA	0-25mm/0-1"	D	±6µm	36	25
3561-50DA	25-50mm/1-2"	D	±6µm	61	32
3561-25EA	0-25mm/0-1"	E	±6µm	36	25
3561-50EA	25-50mm/1-2"	E	±6µm	61	32
3561-25FA	0-25mm/0-1"	F	±6µm	36	25
3561-50FA	25-50mm/1-2"	F	±6µm	61	32

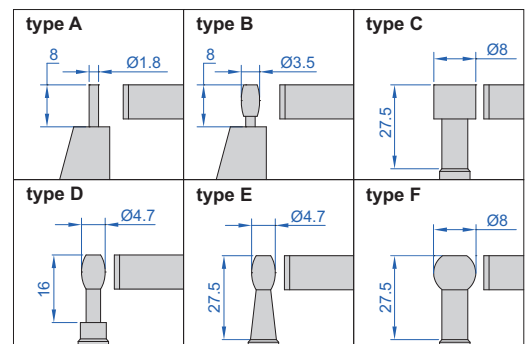

SPHERICAL ANVIL TUBE MICROMETERS

- Meet DIN863-3
- Measure wall thickness of tubes
- Graduation 0.01mm
- Ratchet stop
- Carbide measuring faces
- Supplied with setting standards (except 0-25mm)



3260-25A

Code	Range	Type	Accuracy	L	b
3260-25A	0-25mm	A	4μm	32	24
3260-50A	25-50mm	A	4μm	57	32
3260-75A	50-75mm	A	5μm	82	44.5
3260-100A	75-100mm	A	5μm	107	57
3260-25SA	0-25mm	B	4μm	32	24
3260-50SA	25-50mm	B	4μm	57	32
3260-75SA	50-75mm	B	5μm	82	44.5
3260-100SA	75-100mm	B	5μm	107	57

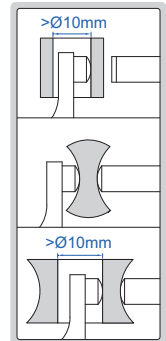
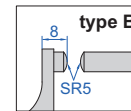
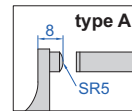
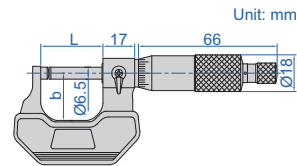

IP65
WATERPROOF

DATA
OUTPUT

DIGITAL SPHERICAL ANVIL TUBE MICROMETERS

- Measure wall thickness of tubes
- Resolution 0.001mm/0.00005"
- IP65 dust/waterproof
- Button function: on/off, set, mm/inch, data transmit
- Data output
- Automatic power off
- Ratchet stop
- Carbide measuring faces
- Supplied with setting standards (except 0-25mm/0-1")
- Optional accessory:
wireless transmitter code **7315-31** (receiver is needed) page 6,
bluetooth transmitter code **7214-31** page 12,
data output cable code **7302-31** page 20



3560-25A

Code	Range	Type	Accuracy	L	b
3560-25A	0-25mm/0-1"	A	±4μm	32	24
3560-50A	25-50mm/1-2"	A	±4μm	57	32
3560-75A	50-75mm/2-3"	A	±5μm	82	44.5
3560-100A	75-100mm/3-4"	A	±5μm	107	57
3560-25SA	0-25mm/0-1"	B	±4μm	32	24
3560-50SA	25-50mm/1-2"	B	±4μm	57	32
3560-75SA	50-75mm/2-3"	B	±5μm	82	44.5
3560-100SA	75-100mm/3-4"	B	±5μm	107	57

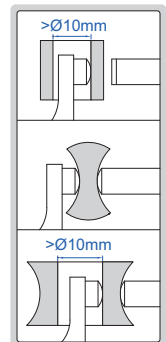
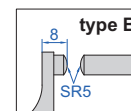
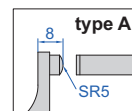
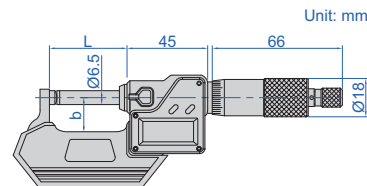

DIGITAL SPHERICAL ANVIL TUBE MICROMETERS/SNAP GAUGES

IP65
WATERPROOF

NON-ROTATING
SPINDLE

ABSOLUTE ENCODER, THE ORIGINAL
DATA REMAINS AFTER POWER OFF

ONE TURN OF SLEEVE MAKES 5MM SPINDLE FEED,
PRESS THE FORK, THE SPINDLE RETRACTS 3MM

MEASUREMENT ACCURACY IS NOT
AFFECTED BY THE USE OF SLEEVE

INSPECTION
CERTIFICATE

ATTENTION: RECHARGEABLE BATTERY,
FOR 24 HOURS CONTINUOUS WORKING

DATA
OUTPUT



6

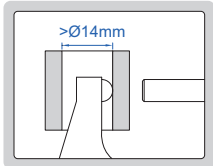

3355-25

- Measure wall thickness of tubes
- Absolute encoder, the original data remains after power off
- Adjustable resolution: 0.0002mm/0.00001"
0.001mm/0.00005"
0.01mm/0.0005"
- One turn of sleeve makes 5mm spindle feed
- Measurement accuracy is not affected by the use of sleeve
- Press the fork, the spindle retracts 3mm
- Linear ball bearings for ten million times use
- Carbide spindle and anvil
- Measuring force 7-10N
Customizable measuring force range 2-12N
Attention: small measuring force will reduce the dustproof and waterproof level
- Button function: data output, tolerance, data preset, data hold, measuring direction change, max./min./TIR, power off time, on/off, zero, mm/inch, adjust resolution
- Supplied with gauge blocks for zero setting (except 0-25mm/0-1")
- Power: rechargeable battery, for 24 hours continuous working

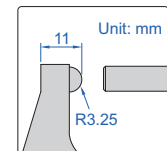
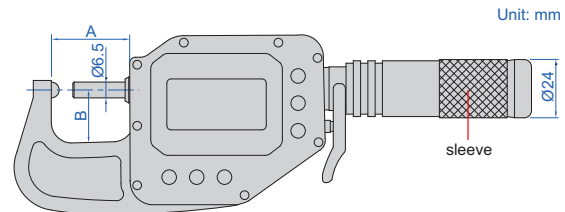

With data interface

Optional accessory:
wireless transmitter code **7315-3350** (receiver is needed) page 7
data output cable (keyboard format) code **7302-3350** page 21

Code	Range	Accuracy	Repeatability	A	B
3355-25 *	0-25mm/0-1"	2µm	1µm	38mm	24mm
3355-50 *	25-50mm/1-2"	2µm	1µm	63mm	25mm
3355-75 *	50-75mm/2-3"	2µm	1µm	88mm	42mm
3355-100 *	75-100mm/3-3.95"	2µm	1µm	113mm	56mm

Built-in wireless

Optional accessory:
wireless receiver (keyboard format, connect up to 15 digital indicators), code **2134-R1**
wireless receiver (serial port format, connect up to 15 digital indicators), code **2134-R2**

Code	Range	Accuracy	Repeatability	A	B
3355-25WL*	0-25mm/0-1"	2µm	1µm	38mm	24mm
3355-50WL*	25-50mm/1-2"	2µm	1µm	63mm	25mm
3355-75WL*	50-75mm/2-3"	2µm	1µm	88mm	42mm
3355-100WL*	75-100mm/3-3.95"	2µm	1µm	113mm	56mm

*Supplied with manufacturer inspection certificate

alarm when
over tolerance

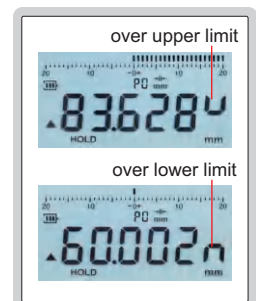

wireless receiver
2134-R1, 2134-R2 (optional)



RELATIVE PRODUCT: DIGITAL DISK BRAKE AND PAD CALIPER
DIGITAL DRUM BRAKE CALIPER (CODE 1162-125A, 1167-150A, 1168-300A)

DISK BRAKE MICROMETERS

- Measure thickness of disk brakes
- Graduation 0.01mm
- Ratchet stop
- Carbide measuring faces
- Supplied with setting standards

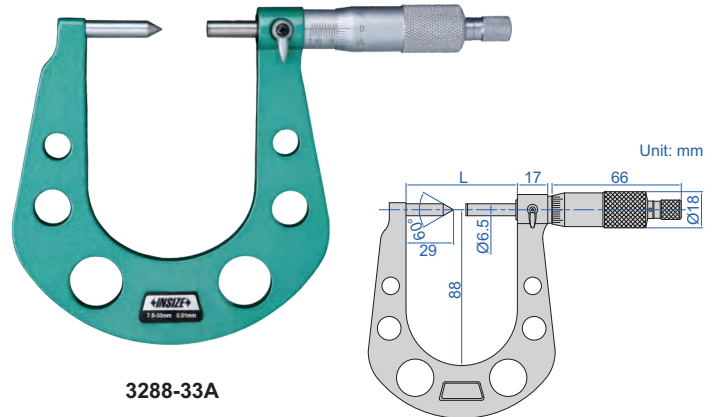

3288-33A

Code	Range	Accuracy	L
3288-33A	7.6-33mm	5µm	64.5mm
3288-50A	25-50mm	5µm	82mm

RELATIVE PRODUCT: DIGITAL DISK BRAKE AND PAD CALIPER
DIGITAL DRUM BRAKE CALIPER (CODE 1162-125A, 1167-150A, 1168-300A)

DIGITAL DISK BRAKE MICROMETERS

- Measure thickness of disk brakes
- Resolution 0.001mm/0.00005"
- IP65 dust/waterproof
- Button function: on/off, set, mm/inch, data transmit
- Data output
- Automatic power off
- Ratchet stop
- Carbide measuring faces
- Supplied with setting standards
- Optional accessory: wireless transmitter code 7315-31 (receiver is needed) page 6, bluetooth transmitter code 7214-31 page 12, data output cable code 7302-31 page 20



3588-33A

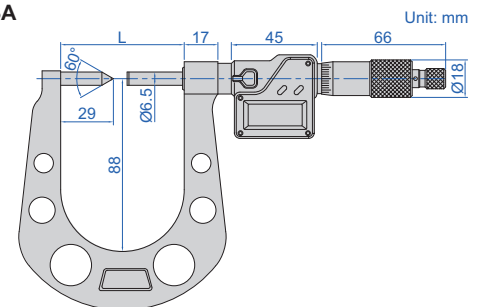

IP65
WATERPROOF

DATA
OUTPUT

Code	Range	Accuracy	L
3588-33A	7.6-33mm/0.3-1.3"	±5µm	64.5mm
3588-50A	25-50mm/1-2"	±5µm	82mm

ATTENTION: SETTING
STANDARDS ARE NOT INCLUDED

SHEET METAL MICROMETERS

INSIZE PLUS
MADE IN EUROPE

- Deep frame suitable for sheet metal, paper and plastic
- Graduation 0.01mm
- Ratchet stop
- Carbide measuring faces
- Optional accessory: setting standards (code 7386)

Code	Range	Accuracy	(mm)	
			b	Ød
3653-251A	0-25mm	4µm	50	6.5
3653-252A	0-25mm	5µm	100	8
3653-253A	0-25mm	6µm	150	6.5
3653-254A	0-25mm	8µm	250	6.5
3653-501A	25-50mm	4µm	50	8
3653-502A	0-50mm	4µm	50	8
3653-503A	0-50mm	5µm	100	8
3653-100A	50-100mm	5µm	100	8



3653-252A

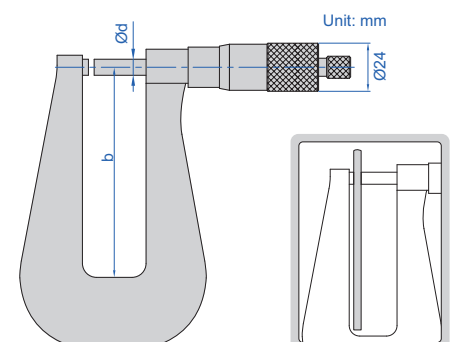

SHEET METAL MICROMETERS

- Deep frame suitable for sheet metal, paper and plastic
- Graduation 0.01mm
- Ratchet stop
- Carbide measuring faces

Code	Range	Type	Accuracy	b
3239-253	0-25mm	A	7µm	155mm
3239-253F	0-25mm	B	7µm	155mm
3239-254F	0-25mm	B	10µm	310mm
3239-253S	0-25mm	C	7µm	155mm



3239-253

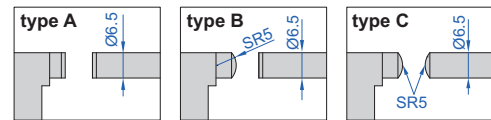
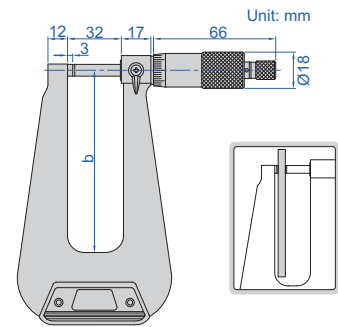

DIGITAL SHEET METAL MICROMETERS

- Deep frame suitable for sheet metal, paper and plastic
- Resolution 0.001mm/0.00005"
- IP65 dust/waterproof
- Button function: on/off, set, mm/inch, data transmit
- Data output
- Automatic power off
- Ratchet stop
- Carbide measuring faces
- Optional accessory: wireless transmitter code 7315-31 (receiver is needed) page 6, bluetooth transmitter code 7214-31 page 12, data output cable code 7302-31 page 20

Code	Range	Type	Accuracy	b
3539-253A	0-25mm/0-1"	A	±7µm	155mm
3539-253FA	0-25mm/0-1"	B	±7µm	155mm
3539-254FA	0-25mm/0-1"	B	±10µm	310mm
3539-253SA	0-25mm/0-1"	C	±7µm	155mm



3539-253A

DATA OUTPUT IP65 WATERPROOF

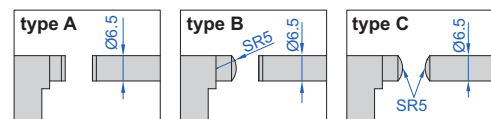
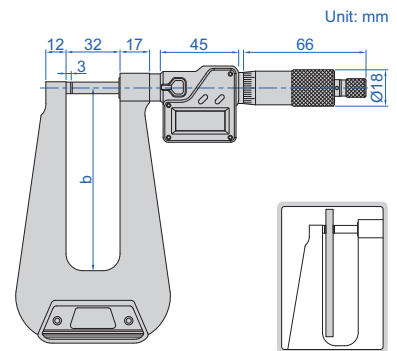

INTERCHANGEABLE ANVIL MICROMETERS

- Measure tube thickness, shoulder edge distance, rivet head height, etc.
- Supplied with flat anvil and rod anvil
- Graduation 0.01mm
- Ratchet stop
- Carbide spindle tip
- Setting standards are included (except 0-25mm)



3262-25A

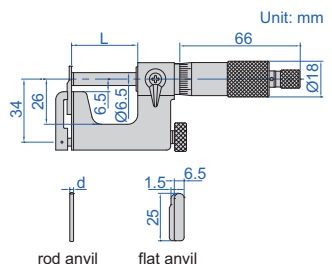

Code	Range	Accuracy	L	d
3262-25A	0-25mm	4µm	28.5mm	Ø3mm
3262-50A	25-50mm	4µm	53.5mm	Ø5mm

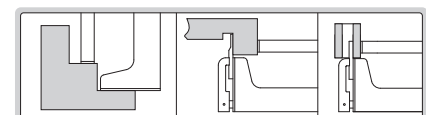

IP65
WATERPROOF

DATA
OUTPUT

DIGITAL INTERCHANGEABLE ANVIL MICROMETERS

- Measure tube thickness, shoulder edge distance, rivet head height, etc.
- Supplied with flat anvil and rod anvil
- Resolution 0.001mm/0.00005"
- IP65 dust/waterproof
- Button function: on/off, set, mm/inch, data transmit
- Data output
- Automatic power off
- Ratchet stop
- Carbide spindle tip
- Setting standards are included (except 0-25mm/0-1")
- Optional accessory:
wireless transmitter code **7315-31** (receiver is needed) page 6,
bluetooth transmitter code **7214-31** page 12,
data output cable code **7302-31** page 20



3562-25A

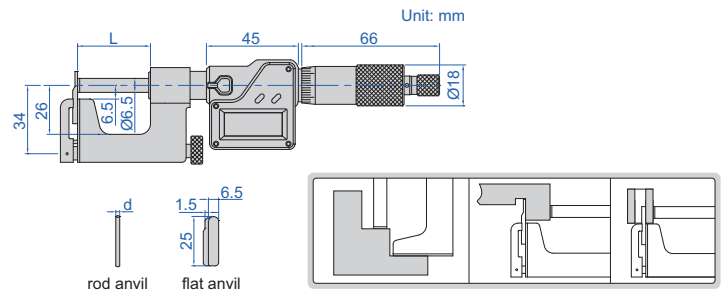

Code	Range	Accuracy	L	d
3562-25A	0-25mm/0-1"	±4µm	28.5mm	Ø3mm
3562-50A	25-50mm/1-2"	±4µm	53.5mm	Ø5mm

6

LARGE ANVIL MICROMETERS

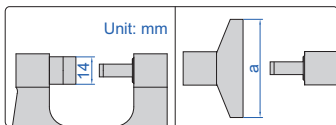

3234-25A

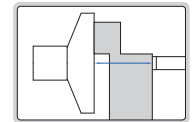

- Graduation 0.01mm
- Ratchet stop
- Supplied with setting standards (except 0-25mm)

Code	Range	Accuracy	L	a	b
3234-25A	0-25mm	4µm	42mm	50mm	26mm
3234-50A	25-50mm	4µm	67mm	60mm	38mm

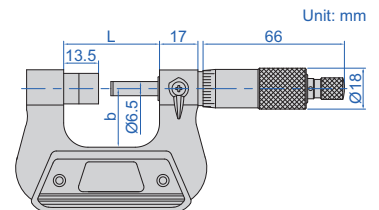

DIGITAL LARGE ANVIL MICROMETERS

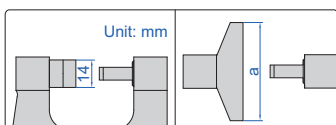

DATA
OUTPUT

IP65
WATERPROOF



3534-25A

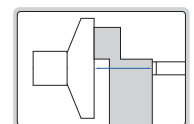

- Resolution 0.001mm/0.00005"
- IP65 dust/waterproof
- Button function: on/off, set, mm/inch, data transmit
- Data output
- Automatic power off
- Ratchet stop
- Supplied with setting standards (except 0-25mm/0-1")
- Optional accessory:
wireless transmitter code **7315-31** (receiver is needed) page 6,
bluetooth transmitter code **7214-31** page 12,
data output cable code **7302-31** page 20

Code	Range	Accuracy	L	a	b
3534-25A	0-25mm/0-1"	±4µm	42mm	50mm	26mm
3534-50A	25-50mm/1-2"	±4µm	67mm	60mm	38mm

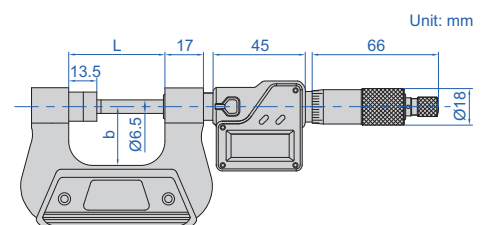

V-ANVIL MICROMETERS



3290-153A

- Measure the diameter of parts or cutting tools with odd grooves, such as taps, reamers and end mills
- Graduation 0.01mm
- Ratchet stop
- Carbide measuring faces
- Supplied with setting standards

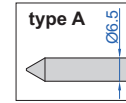
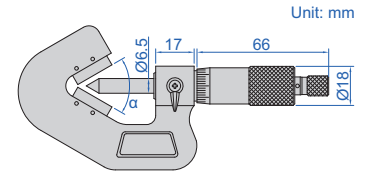

6

Code	Range	Flutes	Accuracy	α	Type
3290-153A	1-15mm	3	4 μ m	60°	A
3290-203A	5-20mm	3	4 μ m	60°	B
3290-353A	20-35mm	3	5 μ m	60°	B
3290-503A	35-50mm	3	5 μ m	60°	B
3290-653A	50-65mm	3	6 μ m	60°	B
3290-803A	65-80mm	3	6 μ m	60°	B
3290-953A	80-95mm	3	7 μ m	60°	B
3290-255A	5-25mm	5	4 μ m	108°	B

Code	Range	Flutes	Accuracy	α	Type
3290-455A	25-45mm	5	5 μ m	108°	B
3290-655A	45-65mm	5	6 μ m	108°	B
3290-855A	65-85mm	5	7 μ m	108°	B
3290-1055A	85-105mm	5	8 μ m	108°	B
3290-257A	5-25mm	7	4 μ m	128°34'17"	B
3290-457A	25-45mm	7	5 μ m	128°34'17"	B
3290-657A	45-65mm	7	6 μ m	128°34'17"	B
3290-857A	65-85mm	7	7 μ m	128°34'17"	B

DIGITAL V-ANVIL MICROMETERS

IP65
WATERPROOF

DATA
OUTPUT

- Measure the diameter of parts or cutting tools with odd grooves, such as taps, reamers and end mills
- Resolution 0.001mm/0.00005"
- IP65 dust/waterproof
- Button function: on/off, set, mm/inch, data transmit
- Data output
- Automatic power off
- Ratchet stop
- Carbide measuring faces
- Supplied with setting standards
- Optional accessory:
 - wireless transmitter code **7315-31** (receiver is needed) page 6,
 - bluetooth transmitter code **7214-31** page 12,
 - data output cable code **7302-31** page 20



3590-153A

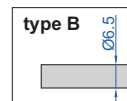
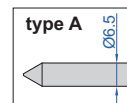
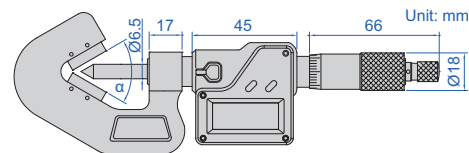

Code	Range	Flutes	Accuracy	α	Type
3590-153A	1-15mm/0.04-0.6"	3	±4 μ m	60°	A
3590-203A	5-20mm/0.2-0.8"	3	±4 μ m	60°	B
3590-353A	20-35mm/0.8-1.4"	3	±5 μ m	60°	B
3590-503A	35-50mm/1.4-2.0"	3	±5 μ m	60°	B
3590-653A	50-65mm/2.0-2.6"	3	±6 μ m	60°	B
3590-803A	65-80mm/2.6-3.2"	3	±6 μ m	60°	B
3590-953A	80-95mm/3.2-3.6"	3	±6 μ m	60°	B
3590-255A	5-25mm/0.2-1.0"	5	±4 μ m	108°	B

Code	Range	Flutes	Accuracy	α	Type
3590-455A	25-45mm/1.0-1.8"	5	±5 μ m	108°	B
3590-655A	45-65mm/1.8-2.6"	5	±6 μ m	108°	B
3590-855A	65-85mm/2.6-3.4"	5	±6 μ m	108°	B
3590-1055A	85-105mm/3.4-4.2"	5	±6 μ m	108°	B
3590-257A	5-25mm/0.2-1.0"	7	±4 μ m	128°34'17"	B
3590-457A	25-45mm/1.0-1.8"	7	±4 μ m	128°34'17"	B
3590-657A	45-65mm/1.8-2.6"	7	±5 μ m	128°34'17"	B
3590-857A	65-85mm/2.6-3.4"	7	±5 μ m	128°34'17"	B

NON-ROTATING SPINDLE

NON-ROTATING SPINDLE UNIVERSAL MICROMETERS



3280-25A

- Meet DIN863-3
- Graduation 0.01mm
- Non-rotating spindle
- Ratchet stop
- Supplied with 7 pairs of anvil/spindle tip
- Setting standards are included (except 0-25mm)
- Optional accessory: 55° anvil/spindle tip (code **3280-SP1** and **3280-SP2**)

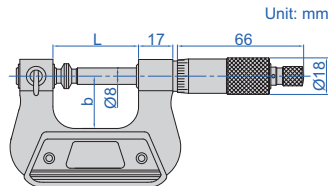

Unit: mm

Code	Range	Accuracy	L	b
3280-25A	0-25mm	4µm	42mm	26mm
3280-50A	25-50mm	4µm	67mm	38mm
3280-75A	50-75mm	5µm	92mm	50mm
3280-100A	75-100mm	5µm	118mm	62mm
3280-125A	100-125mm	6µm	143mm	70mm
3280-150A	125-150mm	6µm	168mm	82mm
3280-175A	150-175mm	7µm	192mm	95mm
3280-200A	175-200mm	7µm	217mm	107mm

Anvil/spindle tip (included) Unit: mm

Flat		
Spherical		
Spline		
Disk		
Blade		
Knife-edge		
Point		

55° anvil/spindle tip (optional) Unit: mm

Code 3280-SP1 Knife-edge		
Code 3280-SP2 Point		

NON-ROTATING SPINDLE

DATA OUTPUT

DIGITAL UNIVERSAL MICROMETERS



3580-25A

- Resolution 0.001mm/0.00005"
- Non-rotating spindle
- Button function: on/off, set, mm/inch, data transmit
- Data output
- Automatic power off
- Ratchet stop
- Supplied with 7 pairs of anvil/spindle tip
- Setting standards are included (except 0-25mm/0-1")
- Optional accessory: 55° anvil/spindle tip code **3280-SP1** and **3280-SP2**, wireless transmitter code **7315-31** (receiver is needed) page 6, bluetooth transmitter code **7214-31** page 12, data output cable code **7302-31** page 20

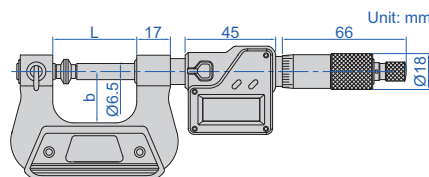

Unit: mm

Code	Range	Accuracy	L	b
3580-25A	0-25mm/0-1"	±4µm	42	26
3580-50A	25-50mm/1-2"	±4µm	67	38
3580-75A	50-75mm/2-3"	±5µm	92	50
3580-100A	75-100mm/3-4"	±5µm	118	62
3580-125A	100-125mm/4-5"	±6µm	143	70
3580-150A	125-150mm/5-6"	±6µm	168	82
3580-175A	150-175mm/6-7"	±7µm	192	95
3580-200A	175-200mm/7-8"	±7µm	217	107

Anvil/spindle tip (included) Unit: mm

Flat		
Spherical		
Spline		
Disk		
Blade		
Knife-edge		
Point		

55° anvil/spindle tip (optional) Unit: mm

Code 3280-SP1 Knife-edge		
Code 3280-SP2 Point		

CALIPER TYPE MICROMETERS

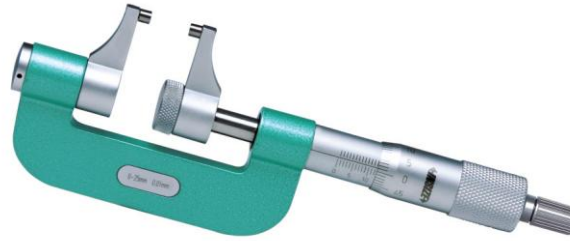
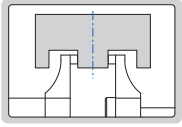

3238-25

- Graduation 0.01mm
- Non-rotating spindle
- Ratchet stop
- Carbide measuring faces
- Supplied with setting standards (except 0-25mm)

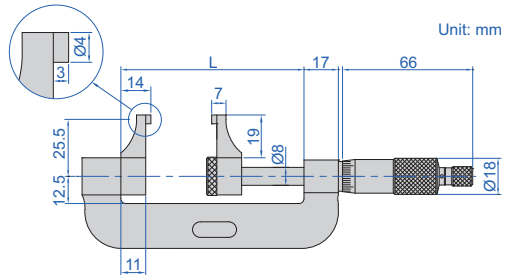

Code	Range	Accuracy	L
3238-25	0-25mm	10µm	56mm
3238-50	25-50mm	10µm	81mm
3238-75	50-75mm	11µm	106mm
3238-100	75-100mm	11µm	131mm

DIGITAL CALIPER TYPE MICROMETERS

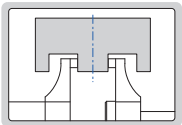

3538-25

- Resolution: 0.001mm/0.00005"
- Non-rotating spindle
- Buttons: on/off, data set, mm/in, ABS/INC
- Data output
- Automatic power off
- Ratchet friction thimble
- Carbide measuring faces
- Supplied with setting standards (except 0-25mm/0-1")

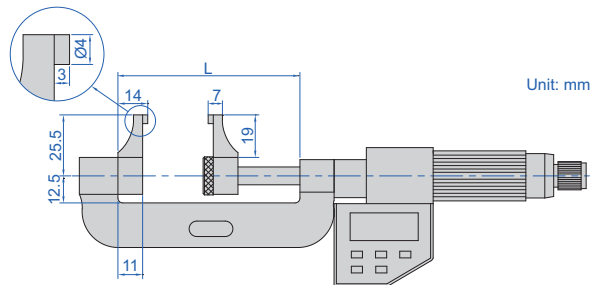

Code	Range	Accuracy	L
3538-25	0-25mm/0-1"	±10µm	56mm
3538-50	25-50mm/1-2"	±10µm	81mm
3538-75	50-75mm/2-3"	±11µm	106mm
3538-100	75-100mm/3-4"	±11µm	131mm

NON-ROTATING SPINDLE

JAW TYPE MICROMETERS



3283-25A

- Graduation 0.01mm
- Non-rotating spindle
- Ratchet stop
- Supplied with setting standards (except 0-25mm)

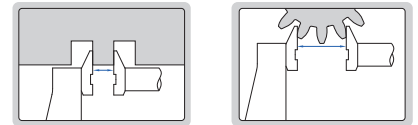
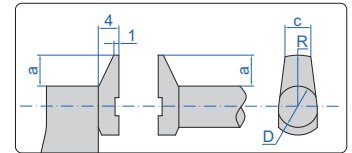
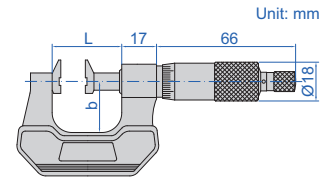

Code	Range	Accuracy	L	a	b	c	R	D
3283-25A	0-25mm	4µm	34	6	24	5	10	8
3283-50A	25-50mm	4µm	59	6	32	5	10	8
3283-75A	50-75mm	5µm	85	6	45	5	10	8
3283-100A	75-100mm	5µm	110	6	57	5	10	8
3283-125A	100-125mm	6µm	138	9	70	8	15	12
3283-150A	125-150mm	6µm	163	9	82	8	15	12
3283-175A	150-175mm	7µm	188	9	95	8	15	12
3283-200A	175-200mm	7µm	214	9	107	8	15	12

DATA OUTPUT

NON-ROTATING SPINDLE

DIGITAL JAW TYPE MICROMETERS



3583-25A

- Resolution 0.001mm/0.00005"
- Non-rotating spindle
- Button function: on/off, set, mm/inch, data transmit
- Data output
- Automatic power off
- Ratchet stop
- Supplied with setting standards (except 0-25mm/0-1")
- Optional accessory:
 - wireless transmitter code **7315-31** (receiver is needed) page 6,
 - bluetooth transmitter code **7214-31** page 12,
 - data output cable code **7302-31** page 20

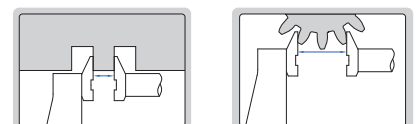
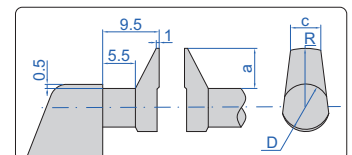
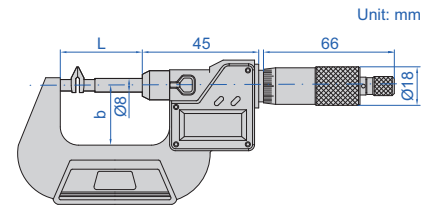

Code	Range	Accuracy	L	a	b	c	R	D
3583-25A	0-25mm/0-1"	±4µm	43	6.5	32	5	10	8
3583-50A	25-50mm/1-2"	±4µm	85	6.5	44.5	5	10	8
3583-75A	50-75mm/2-3"	±5µm	110	6.5	57	5	10	8
3583-100A	75-100mm/3-4"	±5µm	135	6.5	70	5	10	8
3583-125A	100-125mm/4-5"	±6µm	160	11.5	86	8	15	12
3583-150A	125-150mm/5-6"	±6µm	186	11.5	94.5	8	15	12
3583-175A	150-175mm/6-7"	±7µm	211	11.5	107	8	15	12
3583-200A	175-200mm/7-8"	±7µm	236	11.5	120	8	15	12

DISK INDICATING MICROMETERS

INSIZE PLUS
MADE IN EUROPE

INSPECTION
CERTIFICATE

ATTENTION: SETTING
STANDARDS ARE NOT INCLUDED

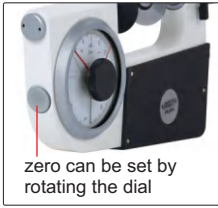

3338-20

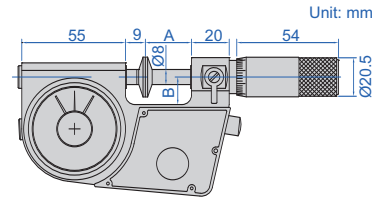

- Meet DIN863-3
- Suitable for measuring the common normal length of spur and helical gears
- Carbide measuring faces
- Measuring force 5-10N
- Optional accessory: gauge blocks grade 0 (4101-A series), for zero setting

(mm)

Code	Micrometer head			Dial indicator			A	B
	range	graduation	accuracy	range	graduation	accuracy		
3338-201 *	0-20mm	0.01mm	4µm	±0.07mm	1µm	2µm	26	15
3338-20 *	0-20mm	0.01mm	4µm	±0.14mm	2µm	4µm	26	15
3338-451 *	20-45mm	0.01mm	4µm	±0.07mm	1µm	2µm	51.5	25
3338-45 *	20-45mm	0.01mm	4µm	±0.14mm	2µm	4µm	51.5	25
3338-701 *	45-70mm	0.01mm	4µm	±0.07mm	1µm	2µm	76.5	37
3338-70 *	45-70mm	0.01mm	4µm	±0.14mm	2µm	4µm	76.5	37
3338-951 *	70-95mm	0.01mm	4µm	±0.07mm	1µm	2µm	101.5	52.5
3338-95 *	70-95mm	0.01mm	4µm	±0.14mm	2µm	4µm	101.5	52.5
3338-120 *	95-120mm	0.01mm	4µm	±0.14mm	2µm	2µm	126.5	65
3338-145 *	120-145mm	0.01mm	4µm	±0.14mm	2µm	4µm	126.5	77.5

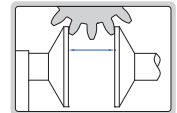
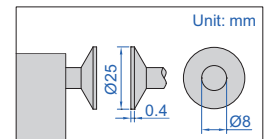

* Supplied with manufacturer inspection certificate

DISK MICROMETERS

INSIZE PLUS
MADE IN EUROPE

ATTENTION: SETTING
STANDARDS ARE NOT INCLUDED

- Graduation: 0.01mm
- Ratchet stop
- One turn of sleeve makes 0.5mm spindle feed
- Optional accessory: setting standards (code 7386)



3676-25

(mm)

Code	Range	Accuracy	L	b
3676-25	0-25mm	4µm	37	24
3676-50	25-50mm	4µm	62	34
3676-75	50-75mm	5µm	87	46
3676-100	75-100mm	5µm	112	60
3676-125	100-125mm	6µm	139	72
3676-150	125-150mm	6µm	164	85
3676-175	150-175mm	7µm	190	97
3676-200	175-200mm	7µm	215	110
3676-225	200-225mm	8µm	240	122
3676-250	225-250mm	8µm	264	135
3676-275	250-275mm	9µm	290	148
3676-300	275-300mm	9µm	315	160

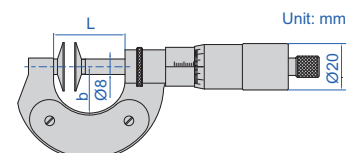
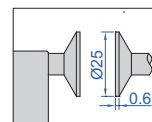
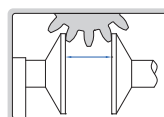

ATTENTION: SETTING STANDARDS ARE NOT INCLUDED

LIGHT WEIGHT

LARGE RANGE DISK MICROMETERS

INSIZE PLUS
MADE IN EUROPE

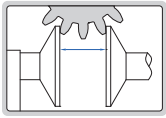

3677-350

- Graduation: 0.01mm
- Ratchet stop
- Quick measurement, one turn of sleeve makes 1mm spindle feed
- Light weight
- Optional accessory: setting standards (code 7386)

(mm)

Code	Range	Accuracy	L	b	Weight
3677-350	300-350mm	8μm	370	190	1.65kg
3677-400	350-400mm	8μm	430	220	1.95kg
3677-450	400-450mm	9μm	475	250	2.30kg
3677-500	450-500mm	9μm	530	273	2.45kg
3677-550	500-550mm	10μm	570	291	2.55kg
3677-600	550-600mm	10μm	630	323	3.15kg
3677-650	600-650mm	10μm	675	351	3.45kg
3677-700	650-700mm	10μm	730	378	3.85kg
3677-750	700-750mm	10μm	785	401	4.05kg
3677-800	750-800mm	10μm	830	423	4.25kg
3677-850	800-850mm	11μm	885	440	4.45kg
3677-900	850-900mm	11μm	930	473	5.05kg
3677-950	900-950mm	11μm	980	503	5.95kg
3677-1000	950-1000mm	11μm	1030	520	6.25kg

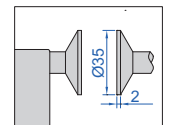
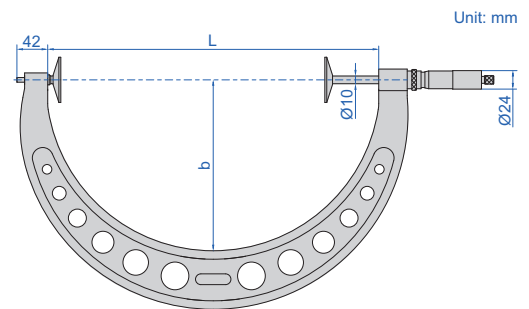

DISK MICROMETERS

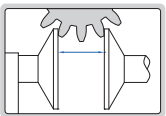

3282-25

- Measure root tangent length of gear
- Graduation 0.01mm
- Ratchet stop
- Supplied with setting standards

(mm)

Code	Range	Accuracy	Parallelism	L	b	c
3282-25	0-25mm	4μm	5μm	34	24	3.3
3282-50	25-50mm	4μm	5μm	59	32	3.3
3282-75	50-75mm	5μm	5μm	85	45	3.3
3282-100	75-100mm	5μm	5μm	110	57	3.3

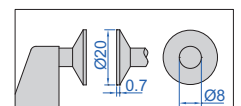
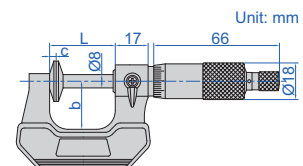

NON-ROTATING SPINDLE DISK MICROMETERS

NON-ROTATING SPINDLE



3294-25

- Measure root tangent length of gear
- Graduation 0.01mm
- Non-rotating spindle
- Ratchet stop
- Supplied with setting standards

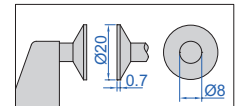
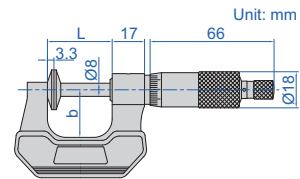
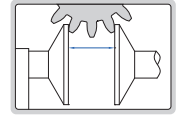

(mm)

Code	Range	Accuracy	Parallelism	L	b
3294-25	0-25mm	4µm	5µm	34	24
3294-50	25-50mm	4µm	5µm	59	32
3294-75	50-75mm	5µm	5µm	85	45
3294-100	75-100mm	5µm	5µm	110	57

6

DIGITAL NON-ROTATING SPINDLE DISK MICROMETERS

DATA OUTPUT

NON-ROTATING SPINDLE



3594-25A

- Measure root tangent length of gear
- Resolution 0.001mm/0.0005"
- Non-rotating spindle
- Button function: on/off, set, mm/inch, data transmit
- Data output
- Automatic power off
- Ratchet stop
- Supplied with setting standards
- Optional accessory:
 - wireless transmitter code **7315-31** (receiver is needed) page 6,
 - bluetooth transmitter code **7214-31** page 12,
 - data output cable code **7302-31** page 20

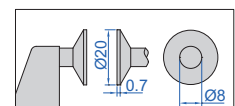
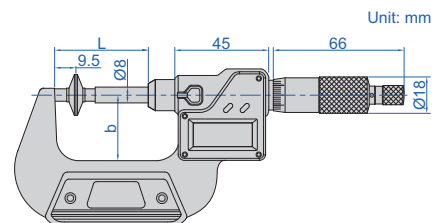
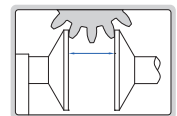

Code	Range	Accuracy	Parallelism	L	b
3594-25A	0-25mm/0-1"	±4µm	5µm	43mm	32mm
3594-50A	25-50mm/1-2"	±4µm	5µm	68mm	44.5mm
3594-75A	50-75mm/2-3"	±5µm	5µm	93mm	57mm
3594-100A	75-100mm/3-4"	±5µm	5µm	118.5mm	70mm

DIGITAL DISK MICROMETERS/SNAP GAUGES

DATA
OUTPUT

NON-ROTATING
SPINDLE

ONE TURN OF SLEEVE MAKES 5MM SPINDLE FEED,
PRESS THE FORK, THE SPINDLE RETRACTS 3MM

ABSOLUTE ENCODER, THE ORIGINAL
DATA REMAINS AFTER POWER OFF

MEASUREMENT ACCURACY IS NOT
AFFECTED BY THE USE OF SLEEVE

ATTENTION: RECHARGEABLE BATTERY,
FOR 24 HOURS CONTINUOUS WORKING

IP65
WATERPROOF



INSPECTION
CERTIFICATE



3353-25

- Measure root tangent length of gear
- Absolute encoder, the original data remains after power off
- Adjustable resolution: 0.0002mm/0.00001"
0.001mm/0.00005"
0.01mm/0.0005"
- One turn of sleeve makes 5mm spindle feed
- Measurement accuracy is not affected by the use of sleeve
- Press the fork, the spindle retracts 3mm
- Linear ball bearings for ten million times use
- Carbide spindle and anvil
- Measuring force 7-10N
Customizable measuring force range 2-12N
Attention: small measuring force will reduce the dustproof and waterproof level
- Button function: data output, tolerance, data preset, data hold, measuring direction change, max./min./TIR, power off time, on/off, zero, mm/inch, adjust resolution
- Supplied with gauge blocks for zero setting
- Power: rechargeable battery, for 24 hours continuous working

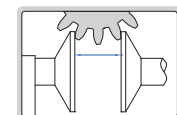
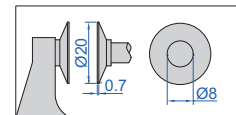
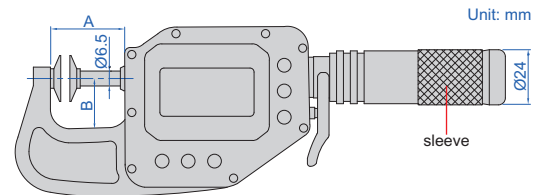

With data interface

Optional accessory:
wireless transmitter code **7315-3350** (receiver is needed) page 7
data output cable (keyboard format) code **7302-3350** page 21

Code	Range	Accuracy	Repeatability	Parallelism	A	B
3353-25 *	0-25mm/0-1"	4µm	1µm	4µm	38mm	24mm
3353-50 *	25-50mm/1-2"	4µm	1µm	4µm	63mm	25mm
3353-75 *	50-75mm/2-3"	5µm	1µm	5µm	88mm	42mm
3353-100 *	75-100mm/3-3.95"	5µm	1µm	5µm	113mm	56mm

alarm when
over tolerance

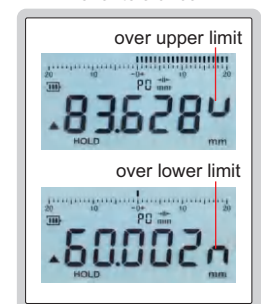

Built-in wireless

Optional accessory:
wireless receiver (keyboard format, connect up to 15 digital indicators), code **2134-R1**
wireless receiver (serial port format, connect up to 15 digital indicators), code **2134-R2**

Code	Range	Accuracy	Repeatability	Parallelism	A	B
3353-25WL *	0-25mm/0-1"	4µm	1µm	4µm	38mm	24mm
3353-50WL *	25-50mm/1-2"	4µm	1µm	4µm	63mm	25mm
3353-75WL *	50-75mm/2-3"	5µm	1µm	5µm	88mm	42mm
3353-100WL *	75-100mm/3-3.95"	5µm	1µm	5µm	113mm	56mm

wireless receiver
2134-R1, 2134-R2 (optional)



* Supplied with manufacturer inspection certificate

SHEET METAL MICROMETERS

- Meet DIN863-3
- Measure thickness of sheet metal, paper, plastic and rubber parts
- Graduation 0.01mm
- Ratchet stop
- Carbide measuring faces



3263-25A

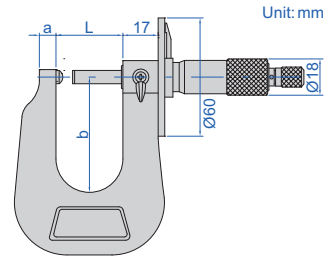
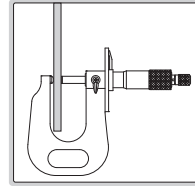

6

Code	Range	Type	Accuracy	L	a	b
3263-15A	0-15mm	A	4µm	22	8	50
3263-25A	0-25mm	A	4µm	32	8	50
3263-50A	0-50mm	A	5µm	57	12	100
3263-15B	0-15mm	B	4µm	22	8	50
3263-25B	0-25mm	B	4µm	32	8	50
3263-50B	0-50mm	B	5µm	57	12	100

(mm)

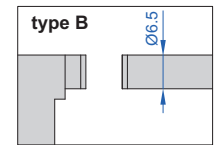
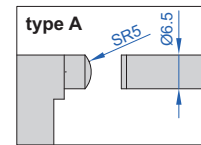

MICROMETERS FOR HOT PLATE



VIDEO

- Measure thickness of hot rolling sheet metal
- Carbide measuring faces
- Supplied with setting standard (except 0-15mm)



3264-15

Code	Range	Graduation	Accuracy
3264-15	0-15mm	0.05mm	0.05mm
3264-30	15-30mm	0.05mm	0.05mm
3264-45	30-45mm	0.05mm	0.05mm
3264-60	45-60mm	0.05mm	0.05mm
3264-75	60-75mm	0.05mm	0.05mm
3264-90	75-90mm	0.05mm	0.05mm
3264-105	90-105mm	0.05mm	0.05mm

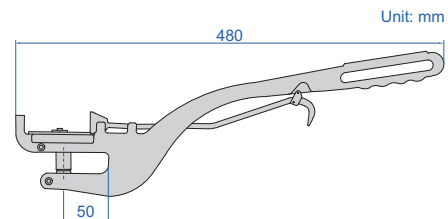

HUB MICROMETERS

- Meet DIN863-3
- Measure hub thickness and shoulder inside a bore
- Graduation 0.01mm
- Ratchet stop
- Carbide measuring faces
- Supplied with setting standards (except 0-25mm)



3292-25

Code	Range	Accuracy	h1	h2	H
3292-25	0-25mm	4µm	6	9	18.7
3292-50	25-50mm	4µm	6.5	11	21.2
3292-75	50-75mm	5µm	6.5	11	21.2
3292-100	75-100mm	5µm	6.5	11	21.2

(mm)

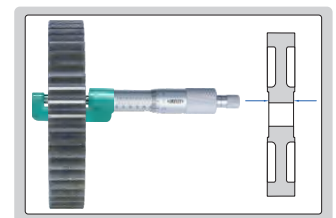
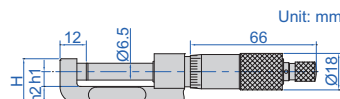

WIRE MICROMETER

- Meet DIN863-3
- Measure diameter of wires and small balls
- Graduation 0.01mm
- Ratchet stop
- Carbide measuring faces



3285-10

Code	Range	Accuracy
3285-10	0-10mm	4μm

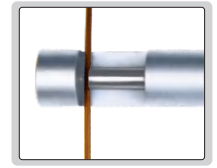
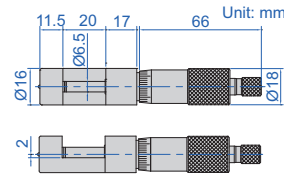

CAN SEAM MICROMETERS



3293-131

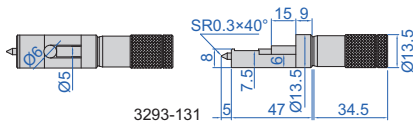

3293-132

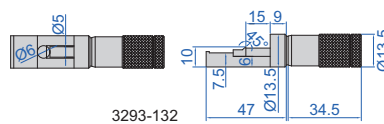

3293-133

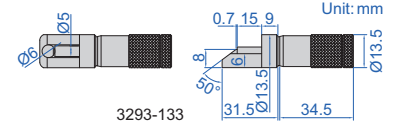

- Measure the width, height and depth of can seams
- Graduation 0.01mm

Code	Range	Accuracy
3293-131	0-13mm	4μm
3293-132	0-13mm	4μm
3293-133	0-13mm	4μm

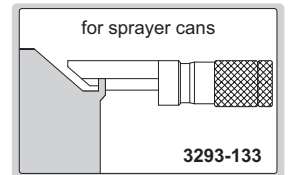
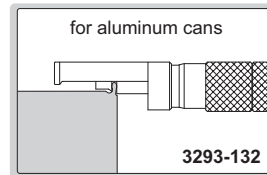
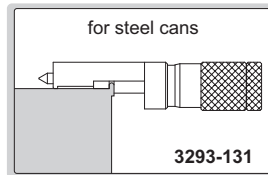

OPTICAL PARALLELS

- Check the flatness and parallelism of measuring faces of micrometer
- Flatness of A and B: 0.1μm
- Parallelism between A and B: 0.6μm

Code	Parallels included (b)	ØD	Applicable micrometer
4184-41A	15.62mm, 15.75mm, 15.87mm, 16.00mm	30mm	0-25mm
4184-42A	40.62mm, 40.75mm, 40.87mm, 41.00mm	30mm	25-50mm
4184-43B	65.62mm, 65.75mm, 65.87mm, 66.00mm	40mm	50-75mm
4184-44B	90.62mm, 90.75mm, 90.87mm, 91.00mm	50mm	75-100mm



4184-41A

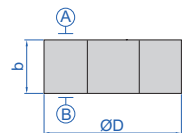

PARALLELISM INSPECT DEVICES FOR OUTSIDE MICROMETERS

- Check parallelism of outside micrometers
- Simple structure, wide measuring range, high reliability
- Stainless steel measuring tips and extension rod
- Supplied with two kinds of measuring tips



4199-1000

MEASURING TIPS DIAMETER ØD CAN BE CUSTOMIZED

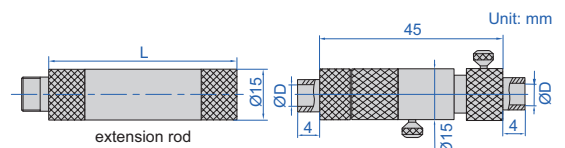

Code	Range	Measuring tips dia. (ØD)	Extension rod (L)
4199-1000	50-1000mm	6.5mm, 8mm	15mm, 25mm, 50mm, 100mm (3 pcs), 150mm, 200mm (2 pcs)
4199-2000	50-2000mm	6.5mm, 8mm	15mm, 25mm, 50mm, 100mm (3 pcs), 150mm, 200mm (7 pcs)

MEASURING TOOLS DYNAMOMETERS



- It can be used for measuring force of micrometers, depth micrometers, dial test indicators, inside micrometers, indicators, micrometer heads and optical instruments (optical meters, contact interferometers) and other force measurement verification
- High precision, wide application, reliable structure, easy to operate



ISF-DGD15

SPECIFICATION

Code	ISF-DGD15	ISF-DGD50
Measuring range	0~15N	0~50N
Resolution	0.01N	
Accuracy	<4N: $\pm 0.01N$; $\geq 4N$: $\pm 0.5\%$	
Dimension	230×220×310mm	
Weight	10kg	

STANDARD DELIVERY

Main unit	1 pc
Disk	1 pc
Rod	2 pcs
Clamping disk	1 pc



clamping disk (included)



disk (included)

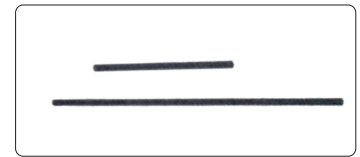

rod (included)



check the measuring force of micrometers



check the measuring force of dial indicators



check the measuring force of dial test indicators



check the measuring force of indicating micrometers



check the measuring force of bore gauges



check the measuring force of calipers

MICROMETER MEASURING FORCE DETECTOR

- For outside micrometers
0-25mm/0-1", 25-50mm/1-2",
50-75mm/2-3" and 75-100mm/3-4"



6315

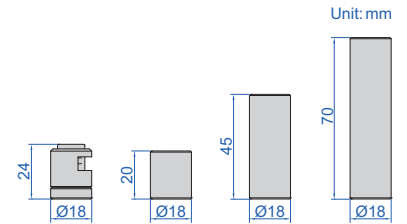

Code	Measuring force
6315	5-12N

REFER TO PAGE 356
FOR DETAILS

MICROMETER INSPECTION GAUGE BLOCK SETS



4107-10



4160-10



6302

MICROMETER STAND

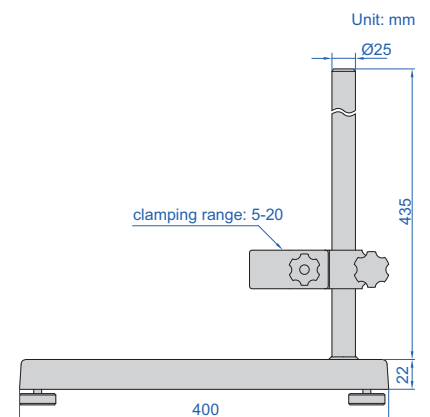

Code
6302

- Suitable for 100-300mm outside micrometers
(except 3675 series)

MICROMETER STAND



6300

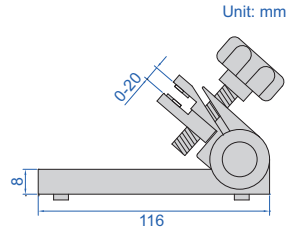

Code
6300

- Suitable for outside micrometers up to 100mm

6

MICROMETER STAND

- Suitable for outside micrometers up to 100mm

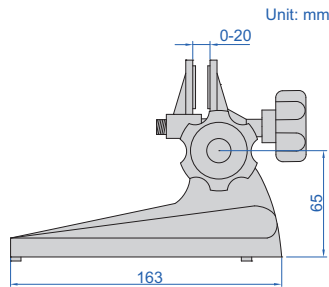

6301

Code
6301

- Suitable for inside micrometers

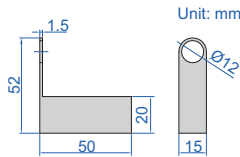

6301-1

Code	Description	Applicable products
6301-1	clamp for inside micrometers	all sizes of 3220 series

- Suitable for three points internal micrometers

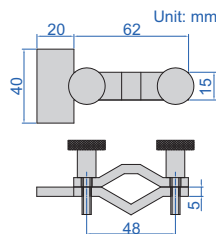

6301-2

Code	Description	Applicable products
6301-2	clamp for three points internal micrometers	up to 100mm of 3127 and 3227 series

MICROMETER SETTING STANDARDS

INSIZE PLUS
MADE IN EUROPE



7386-100

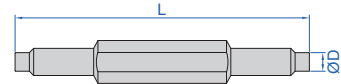

- Suitable for outside micrometers

Code	Length (L)	Accuracy	ØD
7386-25	25mm	±1.25µm	6.5mm
7386-50	50mm	±1.25µm	6.5mm
7386-75	75mm	±1.5µm	6.5mm
7386-100	100mm	±2µm	6.5mm
7386-125	125mm	±2.5µm	6.5mm
7386-150	150mm	±2.5µm	6.5mm
7386-175	175mm	±2.5µm	6.5mm
7386-200	200mm	±3µm	6.5mm
7386-225	225mm	±3µm	6.5mm
7386-250	250mm	±3µm	6.5mm
7386-275	275mm	±3µm	6.5mm
7386-300	300mm	±3µm	10mm
7386-325	325mm	±3.5µm	10mm
7386-350	350mm	±3.5µm	10mm
7386-375	375mm	±3.5µm	10mm
7386-400	400mm	±3.5µm	10mm

Code	Length (L)	Accuracy	ØD
7386-425	425mm	±3.5µm	10mm
7386-450	450mm	±3.5µm	10mm
7386-475	475mm	±3.5µm	10mm
7386-500	500mm	±3.5µm	10mm
7386-525	525mm	±3.5µm	10mm
7386-550	550mm	±3.5µm	10mm
7386-575	575mm	±3.5µm	10mm
7386-600	600mm	±3.5µm	10mm
7386-625	625mm	±4µm	10mm
7386-650	650mm	±4µm	10mm
7386-675	675mm	±4µm	10mm
7386-700	700mm	±4µm	10mm
7386-725	725mm	±4µm	10mm
7386-750	750mm	±4µm	10mm
7386-775	775mm	±4µm	10mm
7386-800	800mm	±4µm	10mm
7386-825	825mm	±4µm	10mm

Code	Length (L)	Accuracy	ØD
7386-850	850mm	±4µm	10mm
7386-875	875mm	±4µm	10mm
7386-900	900mm	±5µm	10mm
7386-925	925mm	±5µm	10mm
7386-950	950mm	±5µm	10mm
7386-975	975mm	±5µm	10mm
7386-1000	1000mm	±5µm	10mm
7386-1050	1050mm	±5µm	10mm
7386-1150	1150mm	±6µm	10mm
7386-1250	1250mm	±7µm	10mm
7386-1350	1350mm	±7µm	10mm
7386-1450	1450mm	±7µm	10mm
7386-1550	1550mm	±9µm	10mm
7386-1650	1650mm	±10µm	10mm
7386-1750	1750mm	±10µm	10mm
7386-1850	1850mm	±11µm	10mm
7386-1950	1950mm	±12µm	10mm

MICROMETER SETTING STANDARDS

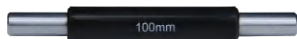

6310-100

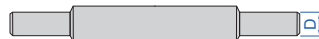

type A



6310-300

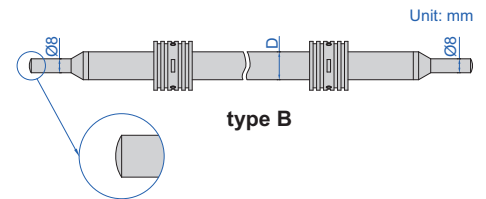

type B

Code	Length	Type	Accuracy	D
6310-25	25	A	±1.5µm	Ø7
6310-50	50	A	±2µm	Ø7
6310-75	75	A	±2.5µm	Ø7
6310-100	100	A	±3µm	Ø8
6310-125	125	A	±3.5µm	Ø8
6310-150	150	A	±4µm	Ø8
6310-175	175	A	±4.5µm	Ø8
6310-200	200	A	±5µm	Ø8
6310-225	225	A	±5.5µm	Ø8
6310-250	250	A	±6µm	Ø8
6310-275	275	A	±6.5µm	Ø8
6310-300	300	B	±7µm	Ø16
6310-325	325	B	±7.5µm	Ø16
6310-350	350	B	±8µm	Ø16
6310-375	375	B	±8.5µm	Ø16

Code	Length	Type	Accuracy	D
6310-400	400	B	±9µm	Ø16
6310-425	425	B	±9.5µm	Ø16
6310-450	450	B	±10µm	Ø16
6310-475	475	B	±10.5µm	Ø16
6310-500	500	B	±11µm	Ø16
6310-525	525	B	±11.5µm	Ø16
6310-575	575	B	±12.5µm	Ø16
6310-625	625	B	±13.5µm	Ø16
6310-675	675	B	±14.5µm	Ø16
6310-725	725	B	±15.5µm	Ø16
6310-775	775	B	±16.5µm	Ø16
6310-825	825	B	±17.5µm	Ø16
6310-875	875	B	±18.5µm	Ø16
6310-925	925	B	±19.5µm	Ø16
6310-975	975	B	±20.5µm	Ø16

Code	Length	Type	Accuracy	D
6310-1050	1050	B	±22µm	Ø23
6310-1150	1150	B	±24µm	Ø23
6310-1250	1250	B	±26µm	Ø23
6310-1350	1350	B	±28µm	Ø23
6310-1450	1450	B	±30µm	Ø23
6310-1550	1550	B	±32µm	Ø23
6310-1650	1650	B	±34µm	Ø23
6310-1750	1750	B	±36µm	Ø23
6310-1850	1850	B	±38µm	Ø23
6310-1950	1950	B	±40µm	Ø23

CALIPER/MICROMETER LAPPING MACHINE CODE 6318



6

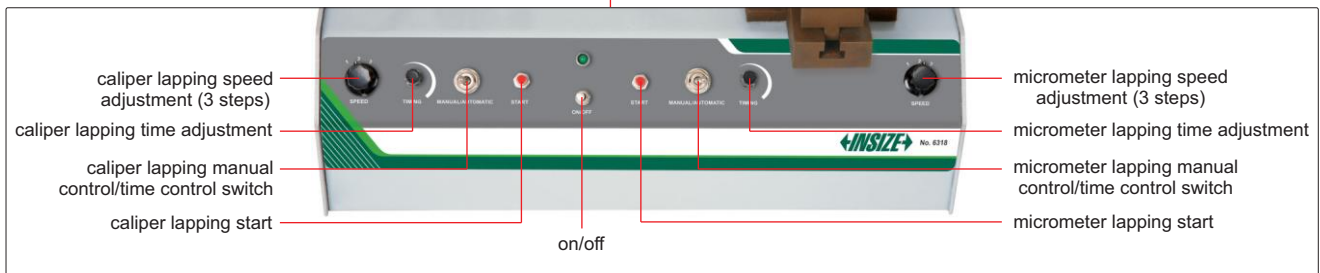

lapping measuring surfaces of caliper lower jaws

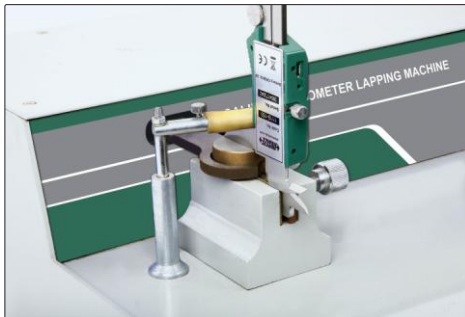

lapping measuring surfaces of outside micrometer



- For lapping measuring surfaces of caliper lower jaws and outside micrometers
- Suitable for 0-300mm range calipers and 0-100mm range outside micrometers
- Supplied with lapping block and diamond paste for calipers
- Lapping blocks for micrometers are optional, diamond paste is included
- Optional accessory: micrometer lapping blocks

caliper lapping block (included)

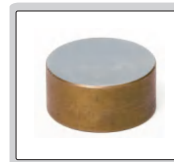

micrometer lapping blocks (code: 6307-1, optional)



SPECIFICATION

Power supply	220V, 50/60Hz
Dimension (L×W×H)	430×400×210mm
Weight	28kg

MICROMETER LAPPING BLOCKS (optional)

Code	For micrometer	Remark
6307-1	0~25mm	includes 4 lapping blocks
6307-2	25~50mm	includes 4 lapping blocks
6307-3	50~75mm	includes 4 lapping blocks
6307-4	75~100mm	includes 4 lapping blocks



MICROMETER LAPPING MACHINE CODE 6307

- Used for lapping micrometer measuring surfaces
- Suitable for 0~100mm outside micrometers
- Supplied with diamond paste
- Optional accessory: micrometer lapping blocks

SPECIFICATION

Power supply	220V, 50/60Hz
Dimension (L×W×H)	360×230×210mm
Weight	15kg

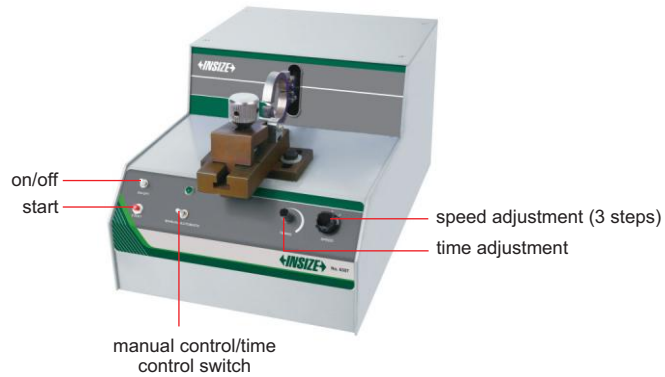

MICROMETER LAPPING BLOCKS (optional)

Code	For micrometer	Remark
6307-1	0~25mm	includes 4 lapping blocks
6307-2	25~50mm	includes 4 lapping blocks
6307-3	50~75mm	includes 4 lapping blocks
6307-4	75~100mm	includes 4 lapping blocks

micrometer lapping blocks (code: 6307-1, optional)



IP65
WATERPROOF

DATA
OUTPUT

DIGITAL MICROMETER HEADS

- Resolution: 0.001mm/0.00005"
- IP65 dust/waterproof
- Button function: on/off, set, mm/inch, data transmit
- Data output, automatic power off
- Ratchet stop
- Optional accessory:
wireless transmitter code **7315-31** (receiver is needed) page 6,
bluetooth transmitter code **7214-31** page 12,
data output cable code **7302-31** page 20



6353-25W

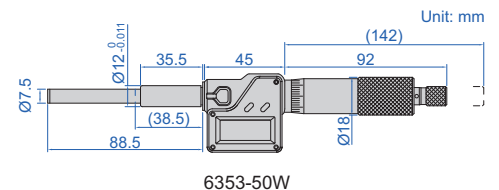
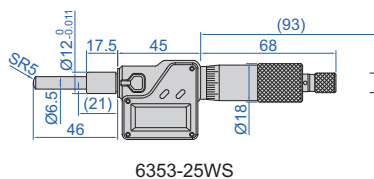
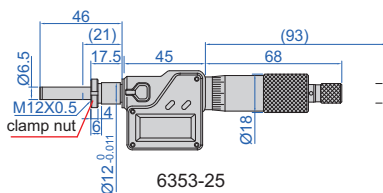

Rotating spindle

Code	Range	Stem	Spindle tip	Accuracy
6353-25	0-25mm/0-1"	with clamp nut	flat (carbide)	±2μm
6353-25W	0-25mm/0-1"	plain	flat (carbide)	±2μm
6353-25S	0-25mm/0-1"	with clamp nut	spherical (SR5)	±2μm
6353-25WS	0-25mm/0-1"	plain	spherical (SR5)	±2μm
6353-50W	0-50mm/0-2"	plain	flat (carbide)	±4μm

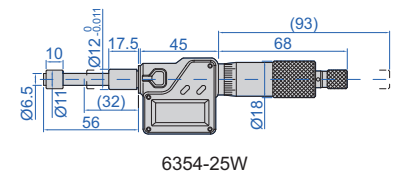

Non-rotating spindle

Code	Range	Stem	Spindle tip	Accuracy
6354-25W	0-25mm/0-1"	plain	flat	±2μm

SMALL MICROMETER HEAD

- Graduation: 0.02mm



6372-5WS

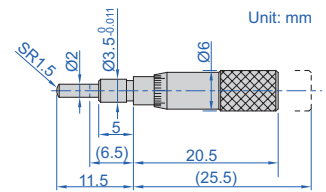

Code	Range	Stem	Spindle tip	Accuracy
6372-5WS	0-5mm	plain	spherical (SR1.5)	5µm

SMALL MICROMETER HEADS

6

- Range: 0-6.5mm
- Graduation: 0.01mm
- Accuracy: 5µm



6385-65W

Code	Stem	Spindle tip
6385-65	with clamp nut	flat
6385-65W	plain	flat
6385-65S	with clamp nut	spherical (SR3)
6385-65WS	plain	spherical (SR3)

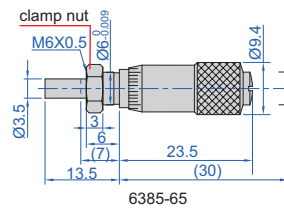

6385-65

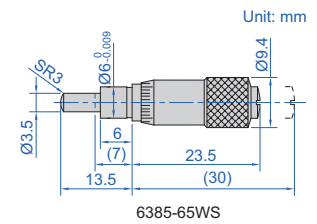

6385-65WS

LARGE THIMBLE MICROMETER HEADS



6373-65

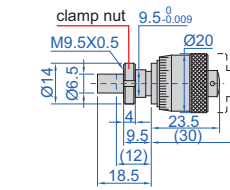

6373-65

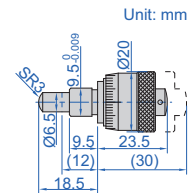

6373-65WS



6373-13

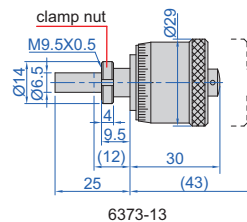

6373-13

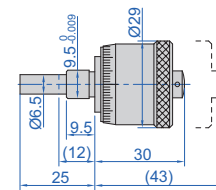

6373-13W

Code	Range	Stem	Spindle tip
6373-65	0-6.5mm	with clamp nut	flat
6373-65W	0-6.5mm	plain	flat
6373-65S	0-6.5mm	with clamp nut	spherical (SR3)
6373-65WS	0-6.5mm	plain	spherical (SR3)
6373-13	0-13mm	with clamp nut	flat
6373-13W	0-13mm	plain	flat

- Meet DIN863-2
- Large thimble diameter for easy reading
- Graduation: 0.01mm
- Accuracy: 3µm

MICROMETER HEADS WITH ZERO ADJUSTABLE THIMBLE

- Meet DIN863-2
- Range: 0-13mm
- Graduation: 0.01mm
- Accuracy: 3µm
- The thimble can be set to zero at any position



6384-13W

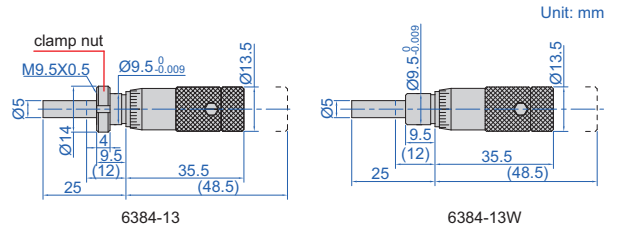

Code	Stem	Spindle tip
6384-13	with clamp nut	flat
6384-13W	plain	flat

MICROMETER HEADS

6

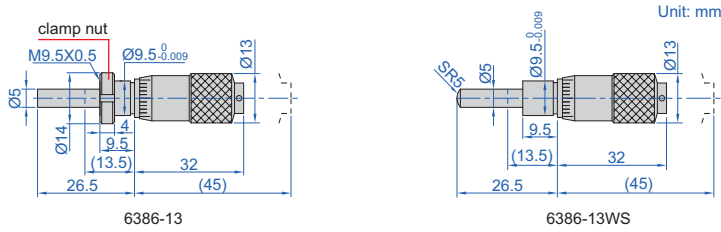

6386-13

6386-13WS



6386-13W

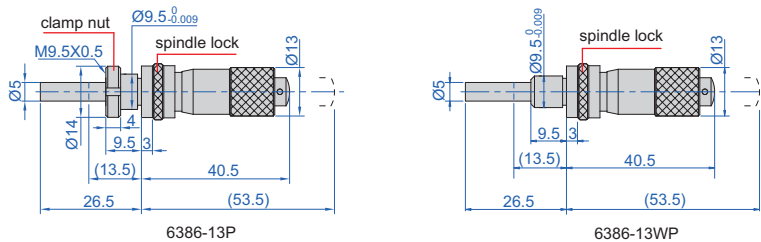

6386-13P

6386-13WP



6386-13P

Code	Range	Stem	Spindle tip	Remark	Accuracy
6386-13	0-13mm	with clamp nut	flat		3µm
6386-13W	0-13mm	plain	flat		3µm
6386-13S	0-13mm	with clamp nut	spherical (SR5)		3µm
6386-13WS	0-13mm	plain	spherical (SR5)		3µm
6386-13P	0-13mm	with clamp nut	flat	with spindle lock	3µm
6386-13WP	0-13mm	plain	flat	with spindle lock	3µm

- Meet DIN863-2
- Graduation: 0.01mm

MICROMETER HEADS

- Meet DIN863-2
- Graduation: 0.01mm
- Accuracy: 3µm



6387-15WS

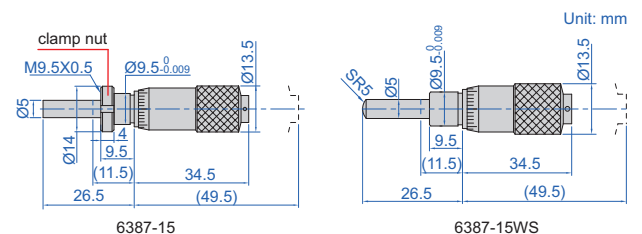

6387-15

6387-15WS

Code	Range	Stem	Spindle tip
6387-15	0-15mm	with clamp nut	flat
6387-15W	0-15mm	plain	flat
6387-15S	0-15mm	with clamp nut	spherical (SR5)
6387-15WS	0-15mm	plain	spherical (SR5)

MICROMETER HEADS



6381-25

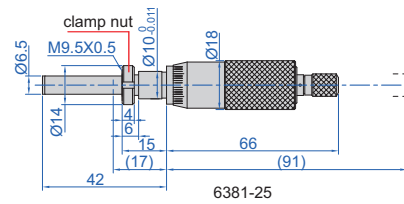

6381-25

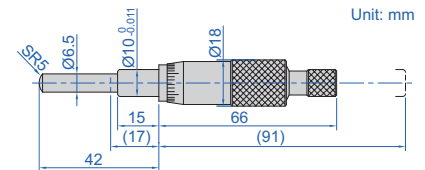

6381-25WS

Unit: mm



6381-25P

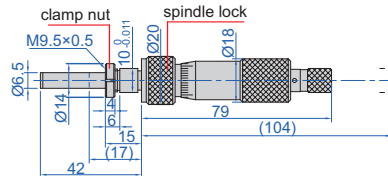

6381-25P

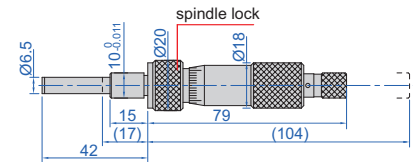

6381-25WP

- Meet DIN863-2
- Graduation: 0.01mm
- Ratchet stop

Code	Range	Stem	Spindle tip	Remark	Accuracy
6381-25	0-25mm	with clamp nut	flat (carbide)		3µm
6381-25W	0-25mm	plain	flat (carbide)		3µm
6381-25S	0-25mm	with clamp nut	spherical (SR5)		3µm
6381-25WS	0-25mm	plain	spherical (SR5)		3µm
6381-25P	0-25mm	with clamp nut	flat (carbide)	with spindle lock	3µm
6381-25WP	0-25mm	plain	flat (carbide)	with spindle lock	3µm

MICROMETER HEADS

NON-ROTATING SPINDLE

- Non-rotating spindle
- One turn of sleeve makes 0.05mm spindle feed
- Carbide measuring faces



6389-1A

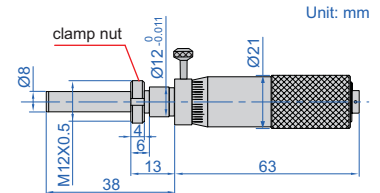

Unit: mm

Code	Range	Graduation	Accuracy	
			full range	within 0.05mm
6389-1A	0-2.5mm	0.001mm	5µm	1.5µm
6389-2A	0-2.5mm	0.001mm	7µm	3µm

NON-ROTATING SPINDLE MICROMETER HEAD

- Meet DIN863-2
- Graduation: 0.01mm
- Ratchet stop
- Non-rotating spindle



6377-25W

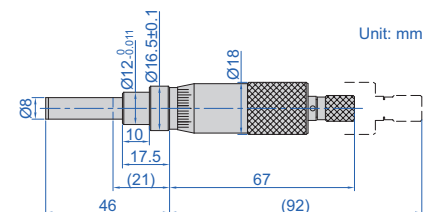

Unit: mm

Code	Range	Stem	Spindle tip	Accuracy
6377-25W	0-25mm	plain	flat (carbide)	3µm

LARGE MICROMETER HEADS



6388-50AW

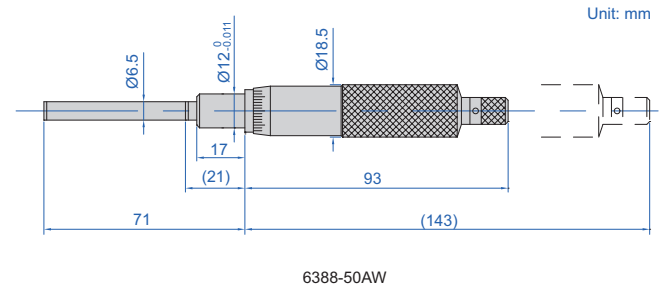
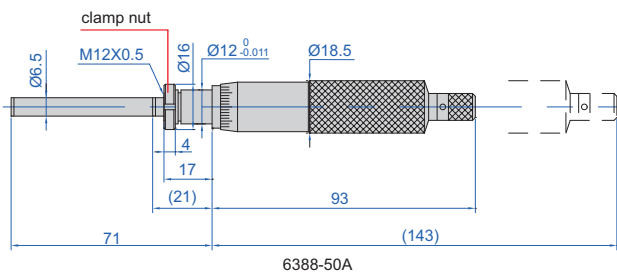

Unit: mm

- Graduation: 0.01mm
- Ratchet stop

Code	Range	Stem	Spindle tip	Accuracy
6388-50A	0-50mm	with clamp nut	flat (carbide)	5µm
6388-50AW	0-50mm	plain	flat (carbide)	5µm

QUICK SPINDLE FEEDING MICROMETER HEADS



6375-15W



6375-25W

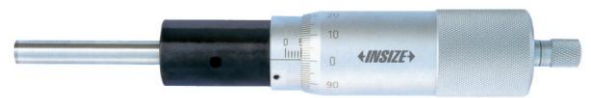

6375-50W

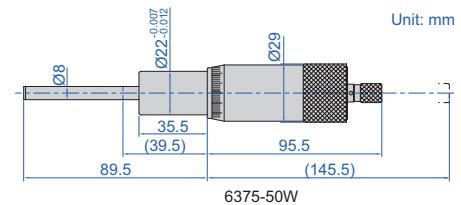
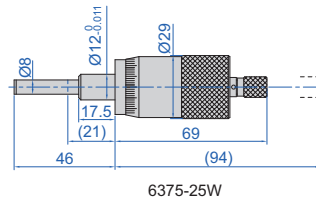
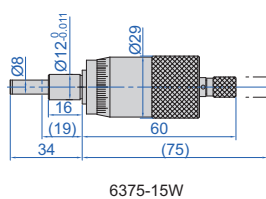

Unit: mm

- Micrometers up to 25mm meet DIN863-2
- Graduation: 0.01mm
- Quick spindle feed of 1mm/rev.
- Ratchet stop

Code	Range	Stem	Spindle tip	Accuracy
6375-15W	0-15mm	plain	flat (carbide)	3µm
6375-25W	0-25mm	plain	flat (carbide)	3µm
6375-50W	0-50mm	plain	flat (carbide)	5µm

07

BORE DIAMETER AND CIRCUMFERENCE MEASURING TOOLS



Inside Micrometers
Page 198-199



Inside Micrometers
Page 199-206



Three Points Internal
Micrometers
Page 207-211



Pistol Grip Three Points
Bore Gauges
Page 212



Bore Plug Gauges
Page 213-214



Bore Gauges
Page 215-226



Carbon Fiber Bore Gauges
Page 225



Bore Gauge Setters
Page 227



Internal Chamfer Gauges
Page 228



Telescoping Gauge Sets
Page 228-229



Circumference Meters
Page 230-231



**INSPECTION
CERTIFICATE**

INSIDE MICROMETERS

INSIZE PLUS
MADE IN EUROPE



3679-55

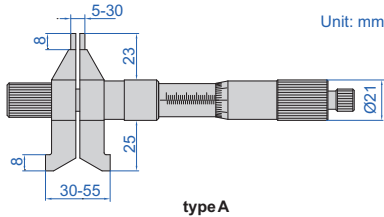

type A



3679-75

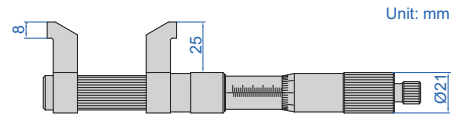

type B

for type A, the upper jaws and lower jaws can be set zero separately



- Graduation: 0.01mm
- Carbide measuring faces
- Ratchet stop
- Optional accessory: setting ring (code **6312**), caliper/height gauge checker (code **6884**)

Code	Range	Type	Accuracy
3679-55 *	5-55mm	A	4µm
3679-75 *	50-75mm	B	5µm
3679-100 *	75-100mm	B	6µm
3679-125 *	100-125mm	B	7µm
3679-150 *	125-150mm	B	8µm
3679-175 *	150-175mm	B	9µm
3679-200 *	175-200mm	B	9µm
3679-225 *	200-225mm	B	10µm
3679-250 *	225-250mm	B	10µm
3679-275 *	250-275mm	B	12µm
3679-300 *	275-300mm	B	12µm

* Supplied with manufacturer inspection certificate

Code	Range	Type	Accuracy
3679-325 *	300-325mm	B	15µm
3679-350 *	325-350mm	B	15µm
3679-375 *	350-375mm	B	16µm
3679-400 *	375-400mm	B	16µm
3679-425 *	400-425mm	B	17µm
3679-450 *	425-450mm	B	17µm
3679-475 *	450-475mm	B	18µm
3679-500 *	475-500mm	B	18µm
3679-525 *	500-525mm	B	19µm
3679-550 *	525-550mm	B	19µm
3679-575 *	550-575mm	B	20µm
3679-600 *	575-600mm	B	20µm

**ATTENTION: LOW PARALLELISM
OF TWO MEASURING FACES**

micrometer stand
with clamp (optional)



- Graduation 0.01mm
- Ratchet stop
- Carbide measuring faces
- Optional accessory: setting ring (code **6312**), micrometer stand and clamp (code **6301** and **6301-1**)

Code	Range	Type	Setting ring	Accuracy
3220-30	5-30mm	A	5mm (included)	7µm
3220-50	25-50mm	B	25mm (included)	8µm
3220-75	50-75mm	B	50mm (optional)	9µm
3220-100	75-100mm	C	75mm (optional)	10µm

INSIDE MICROMETERS (ECONOMIC TYPE)

Unit: mm

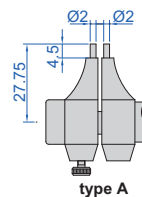

type A



3220-50

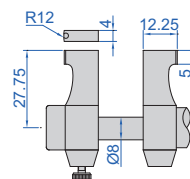

type B

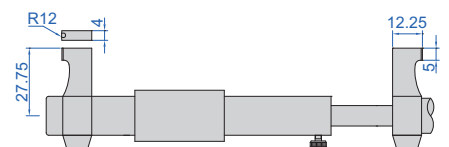

type C

DIGITAL INSIDE MICROMETERS (ECONOMIC TYPE)

DATA
OUTPUT

ATTENTION: LOW PARALLELISM
OF TWO MEASURING FACES

- Resolution 0.001mm/0.00005"
- Button function: on/off, set, mm/inch, data transmit
- Data output
- Automatic power off
- Ratchet stop
- Carbide measuring faces
- Optional accessory: wireless transmitter code **7315-31** (receiver is needed) page 6, bluetooth transmitter code **7214-31** page 12, data output cable code **7302-31** page 20, setting ring (code **6312**)



3520-30

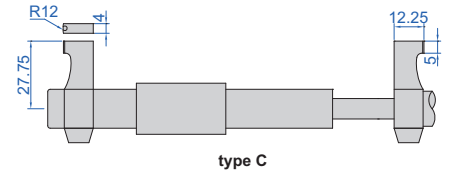
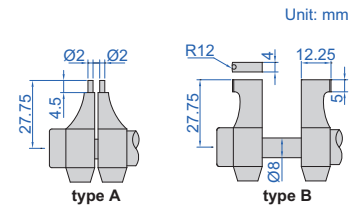

Code	Range	Type	Setting ring	Accuracy
3520-30	5-30mm/0.2-1.2"	A	5mm (included)	±5µm
3520-50	25-50mm/1-2"	B	25mm (included)	±6µm
3520-75	50-75mm/2-3"	B	50mm (optional)	±7µm
3520-100	75-100mm/3-4"	C	75mm (optional)	±8µm

7

INTERNAL GEAR TOOTH MICROMETERS

INSIZE PLUS
MADE IN EUROPE

INSPECTION
CERTIFICATE

- Measure over-pin diameter of gears
- Graduation: 0.01mm
- Ratchet stop
- Optional accessory: ball tips (code **7383**)

before ball tips
are installed ball tips are optional



3678-50

Code	Range	Accuracy	L
3678-50*	25-50mm	4µm	6mm
3678-75*	50-75mm	5µm	8mm

*Supplied with manufacturer inspection certificate

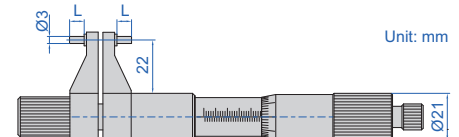
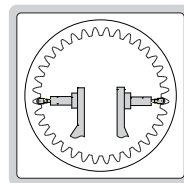

TUBULAR INSIDE MICROMETERS

- Graduation 0.01mm
- Accuracy: (6+L/50)µm
L=maximum measuring length (mm)
- Optional accessory: setting ring (code **6312**), gauge block accessory (code **6881**), cylinder gauge block (code **4001**), caliper/height gauge checker (code **6884**)



3221-200

Code	Range	Travel of micrometer head	Extension rods
3221-32	25-32mm	7mm	—
3221-50	25-50mm	7mm	2 pcs
3221-63	50-63mm	13mm	—
3221-200	50-200mm	13mm	6 pcs
3221-300	50-300mm	13mm	10 pcs
3221-225	200-225mm	25mm	—
3221-500	200-500mm	25mm	3 pcs
3221-1000	200-1000mm	25mm	8 pcs

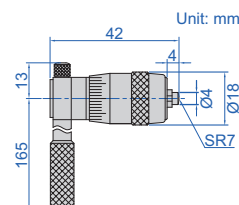

application

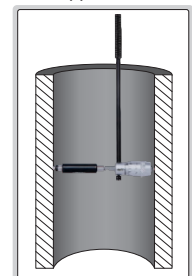

TUBULAR INSIDE MICROMETERS

- Micrometers up to 500mm meet DIN863-4
- Graduation 0.01mm
- Carbide measuring faces
- Optional accessory: gauge block accessory (code **6881**), cylinder gauge block (code **4001**), caliper/height gauge checker (code **6884**)



3229-225

Code	Range	Type	Accuracy
3229-75	50-75mm	A	5μm
3229-100	75-100mm	B	5μm
3229-125	100-125mm	C	6μm
3229-150	125-150mm	C	6μm
3229-175	150-175mm	C	7μm
3229-200	175-200mm	C	7μm
3229-225	200-225mm	C	8μm
3229-250	225-250mm	C	8μm
3229-275	250-275mm	C	9μm
3229-300	275-300mm	C	9μm
3229-325	300-325mm	C	9μm
3229-350	325-350mm	C	9μm
3229-375	350-375mm	C	10μm
3229-400	375-400mm	C	10μm
3229-425	400-425mm	C	10μm
3229-450	425-450mm	C	10μm
3229-475	450-475mm	C	11μm
3229-500	475-500mm	C	11μm
3229-525	500-525mm	C	11μm
3229-550	525-550mm	C	11μm
3229-575	550-575mm	C	11μm
3229-600	575-600mm	C	12μm
3229-625	600-625mm	C	12μm
3229-650	625-650mm	C	12μm
3229-675	650-675mm	C	13μm
3229-700	675-700mm	C	13μm

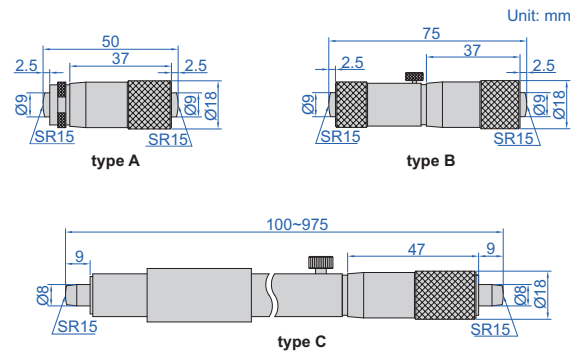

Code	Range	Type	Accuracy
3229-725	700-725mm	C	13μm
3229-750	725-750mm	C	14μm
3229-775	750-775mm	C	14μm
3229-800	775-800mm	C	14μm
3229-825	800-825mm	C	15μm
3229-850	825-850mm	C	15μm
3229-875	850-875mm	C	15μm
3229-900	875-900mm	C	16μm
3229-925	900-925mm	C	16μm
3229-950	925-950mm	C	16μm
3229-975	950-975mm	C	17μm
3229-1000	975-1000mm	C	17μm

TUBULAR INSIDE MICROMETERS



3224-2000

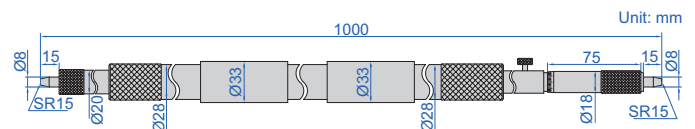

Code	Range	Extension rods
3224-2000	1000-2000mm	50mm, 100mm (2 pcs), 200mm, 500mm
3224-3000	1000-3000mm	50mm, 100mm (2 pcs), 200mm, 500mm, 1000mm
3224-4000	1000-4000mm	50mm, 100mm (2 pcs), 200mm, 500mm, 1000mm (2 pcs)
3224-5000	1000-5000mm	50mm, 100mm (2 pcs), 200mm, 500mm, 1000mm (3 pcs)

- Micrometer head: 1000-1050mm
- Graduation 0.01mm
- Accuracy: $(7+n+L/50)\mu\text{m}$
n=number of rods
L=maximum measuring length (mm)
- Travel of micrometer head 50mm
- Carbide measuring faces

TUBULAR INSIDE MICROMETERS

INSIZE PLUS
MADE IN EUROPE



3684-100

- Micrometer head: 50-75mm
- Graduation: 0.01mm
- Carbide measuring faces

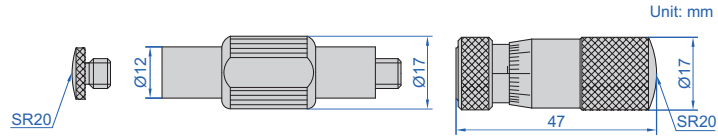

Code	Range	Accuracy	Travel of micrometer head	Extension rods
3684-75	50-75mm	5µm	25mm	—
3684-100	50-100mm	5µm	25mm	25mm
3684-150	50-150mm	6µm	25mm	25mm, 50mm
3684-250	50-250mm	8µm	25mm	25mm, 50mm, 100mm
3684-300	50-300mm	9µm	25mm	25mm, 50mm (2 pcs), 100mm
3684-350	50-350mm	10µm	25mm	25mm, 50mm, 100mm (2 pcs)
3684-450	50-450mm	10µm	25mm	25mm, 50mm, 100mm, 200mm
3684-650	50-650mm	12µm	25mm	25mm, 50mm, 100mm, 200mm (2 pcs)
3684-850	50-850mm	15µm	25mm	25mm, 50mm, 100mm, 200mm, 400mm
3684-1250	50-1250mm	20µm	25mm	25mm, 50mm, 100mm, 200mm, 400mm (2 pcs)
3684-1450	50-1450mm	22µm	25mm	25mm, 50mm, 100mm, 200mm, 400mm, 600mm

7

TUBULAR INSIDE MICROMETERS

INSIZE PLUS
MADE IN EUROPE



3683-200

- Micrometer head: 100-150mm
- Graduation: 0.01mm
- Carbide measuring faces
- Heat insulation extension rods

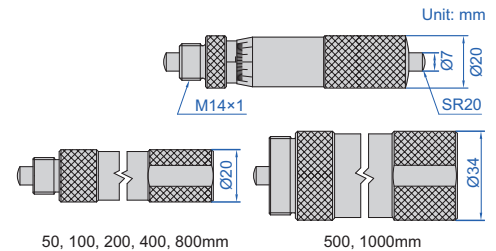

Code	Range	Accuracy	Travel of micrometer head	Heat insulation extension rods
3683-150	100-150mm	6µm	50mm	—
3683-200	100-200mm	7µm	50mm	50mm
3683-300	100-300mm	9µm	50mm	50mm, 100mm
3683-500	100-500mm	13µm	50mm	50mm, 100mm, 200mm
3683-900	100-900mm	16µm	50mm	50mm, 100mm, 200mm, 400mm
3683-1300	100-1300mm	22µm	50mm	50mm, 100mm, 200mm, 400mm (2 pcs)
3683-1700	100-1700mm	27µm	50mm	50mm, 100mm, 200mm, 400mm, 800mm
3683-2000	100-2000mm	32µm	50mm	50mm, 100mm, 200mm (2 pcs), 500mm, 1000mm
3683-2100	100-2100mm	32µm	50mm	50mm, 100mm, 200mm, 400mm (2 pcs), 800mm
3683-2500	100-2500mm	40µm	50mm	50mm, 100mm, 200mm, 400mm, 800mm (2 pcs)
3683-3000	100-3000mm	50µm	50mm	50mm, 100mm, 200mm (2 pcs), 500mm, 1000mm (2 pcs)
3683-4000	100-4000mm	60µm	50mm	50mm, 100mm, 200mm (2 pcs), 500mm, 1000mm (3 pcs)
3683-5000	100-5000mm	72µm	50mm	50mm, 100mm, 200mm (2 pcs), 500mm, 1000mm (4 pcs)
3683-6000	100-6000mm	90µm	50mm	50mm, 100mm, 200mm (2 pcs), 500mm, 1000mm (5 pcs)

TUBULAR INSIDE MICROMETERS

- Micrometer head: 50-63mm
- Graduation 0.01mm
- Accuracy: $(3+n+L/50)\mu\text{m}$
 n =number of rods
 L =maximum measuring length (mm)
- Supplied with setting standards
- Carbide measuring faces

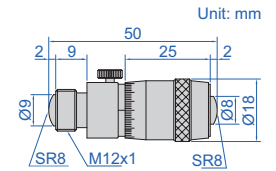

3222-150

Code	Range	Travel of micrometer head	Extension rods
3222-63	50-63mm	13mm	—
3222-150	50-150mm	13mm	13mm, 25mm, 50mm
3222-300	50-300mm	13mm	13mm, 25mm, 50mm (2 pcs), 100mm
3222-500	50-500mm	13mm	13mm, 25mm, 50mm (2 pcs), 100mm, 200mm
3222-600	50-600mm	13mm	13mm, 25mm, 50mm, 100mm, 150mm, 200mm
3222-1000	50-1000mm	13mm	13mm, 25mm, 50mm (2 pcs), 100mm, 200mm (2 pcs), 300mm
3222-1500	50-1500mm	13mm	13mm, 25mm, 50mm (2 pcs), 100mm, 200mm (3 pcs), 300mm (2 pcs)

7

TUBULAR INSIDE MICROMETERS

- Micrometer head: 100-125mm
- Graduation 0.01mm
- Accuracy: $(3+n+L/50)\mu\text{m}$
 n =number of rods
 L =maximum measuring length (mm)
- Travel of micrometer head 25mm
- Supplied with setting standards
- Carbide measuring faces



3225-500

Code	Range	Extension rods
3225-125	100-125mm	—
3225-500	100-500mm	25mm, 50mm, 100mm, 200mm
3225-900	100-900mm	25mm, 50mm, 100mm, 200mm, 400mm
3225-1300	100-1300mm	25mm, 50mm, 100mm, 200mm, 400mm (2 pcs)
3225-1700	100-1700mm	25mm, 50mm, 100mm, 200mm, 400mm (3 pcs)
3225-2100	100-2100mm	25mm, 50mm, 100mm, 200mm, 400mm (4 pcs)

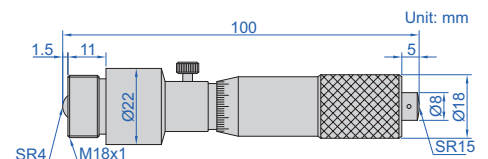

DIGITAL TUBULAR INSIDE MICROMETERS

IP65
WATERPROOF

DATA
OUTPUT

- Micrometer head: 150-175mm
- Resolution: 0.001mm/0.00005"
- Accuracy: $(3+n+L/50)\mu\text{m}$
n=number of rods
L=maximum measuring length (mm)
- Carbide measuring faces
- Diameter of extension rods is 22mm
- IP65 dust/waterproof
- Button function: on/off, set, mm/inch, data transmit
- Data output
- Automatic power off
- Supplied with setting standards
- Optional accessory: wireless transmitter code **7315-31** (receiver is needed) page 6, bluetooth transmitter code **7214-31** page 12, data output cable code **7302-31** page 20

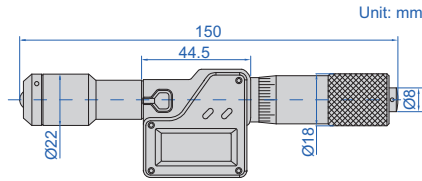

3521-1000

Code	Range	Travel of micrometer head	Extension rods
3521-175	150-175mm	25mm	—
3521-1000	150-1000mm	25mm	25mm, 50mm (2 pcs), 100mm, 200mm, 400mm
3521-1500	150-1500mm	25mm	25mm, 50mm (2 pcs), 100mm (2 pcs), 200mm, 400mm (2 pcs)
3521-2000	150-2000mm	25mm	25mm, 50mm (2 pcs), 100mm, 200mm (2 pcs), 400mm (3 pcs)

TUBULAR INSIDE MICROMETERS

INSIZE PLUS
MADE IN EUROPE

- Carbide measuring faces for micrometer head and extension rods
- Points of extension rods are spring loaded
- Optional accessory:
gauge block accessory (code **6881**),
cylinder gauge block (code **4001**),
caliper/height gauge checker (code **6884**)



3634-1300

Micrometer head

Range	Graduation	Accuracy	Weight
100-125mm	0.01mm	$\pm 4\mu\text{m}$	154g

Extension rods

Length (L)	Accuracy	Weight	Material
25mm	$\pm 1.25\mu\text{m}$	37g	steel
50mm	$\pm 1.25\mu\text{m}$	65g	steel
100mm	$\pm 2\mu\text{m}$	113g	steel
200mm	$\pm 3.5\mu\text{m}$	208g	steel
400mm	$\pm 4.5\mu\text{m}$	402g	steel
1000mm	$\pm 7.5\mu\text{m}$	909g	carbon fiber

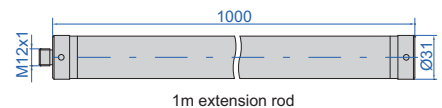
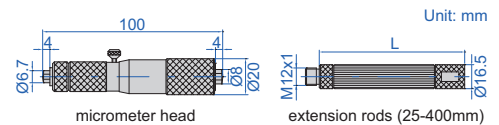

Code	Range	Extension rods
3634-350	100-350mm	25mm, 200mm
3634-500	100-500mm	25mm, 50mm, 100mm, 200mm
3634-1300	100-1300mm	25mm, 50mm, 100mm, 200mm, 400mm (2 pcs)
3634-1500	100-1500mm	25mm, 50mm, 100mm, 200mm (2 pcs), 400mm (2 pcs)
3634-2100	100-2100mm	25mm, 50mm, 100mm, 200mm, 400mm (4 pcs)
3634-3100	100-3100mm	25mm, 50mm, 100mm, 200mm (2 pcs), 400mm, 1000mm (2 pcs)
3634-4100	100-4100mm	25mm, 50mm, 100mm, 200mm (2 pcs), 400mm, 1000mm (3 pcs)
3634-5100	100-5100mm	25mm, 50mm, 100mm, 200mm (2 pcs), 400mm, 1000mm (4 pcs)
3634-6100	100-6100mm	25mm, 50mm, 100mm, 200mm (2 pcs), 400mm, 1000mm (5 pcs)

1m carbon fiber extension rod,
light weight, no deform

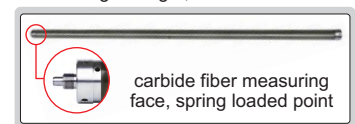

DATA
OUTPUT

SPRING LOADED
MEASURING POINT



NON-ROTATING
SPINDLE

DIGITAL NON-ROTATING SPINDLE INSIDE MICROMETERS

INSIZE PLUS
MADE IN EUROPE

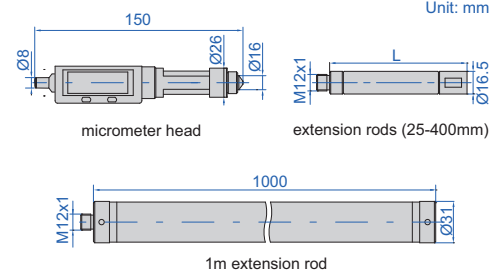

- Carbide measuring faces for micrometer head and extension rods
- Points of extension rods are spring loaded
- Data output
- Button function: mm/inch, max./min. value tracking, preset value, hold, on/off, zero
- CR2032 battery, automatic power off, turn the sleeve to turn on
- Optional accessory: wireless transmitter code **7315-80** (receiver is needed) page 7, data output cable code **7302-80**, gauge block accessory (code **6881**), cylinder gauge block (code **4001**), caliper/height gauge checker (code **6884**)

1m carbon fiber extension rod,
light weight, no deform

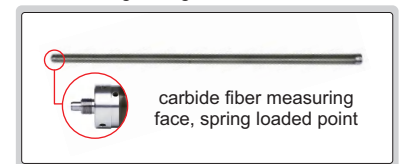

non-rotating spindle, spring loaded point
and max./min. value tracking make it
easy to find the right measuring position

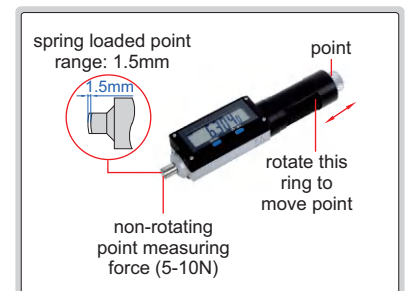

Extension rods

Length (L)	Accuracy	Weight	Material
25mm	±1.25µm	37g	steel
50mm	±1.25µm	65g	steel
100mm	±2µm	113g	steel
200mm	±3.5µm	208g	steel
400mm	±4.5µm	402g	steel
1000mm	±7.5µm	909g	carbon fiber

Micrometer head

Range	Resolution	Accuracy	Repeatability	Measuring force	Weight
150-180mm/6-7"	0.001mm/0.00005" 0.01mm/0.0005" 0.0005mm/0.00002" (switchable)	±4µm	1µm	5-10N	275g

Code	Range	Extension rods
3635-350	150-350mm/6-14"	25mm, 50mm, 100mm
3635-550	150-550mm/6-22"	25mm, 50mm, 100mm, 200mm
3635-950	150-950mm/6-38"	25mm, 50mm, 100mm, 200mm, 400mm
3635-1550	150-1550mm/6-62"	25mm, 50mm, 100mm, 200mm (2 pcs), 400mm (2 pcs)
3635-2150	150-2150mm/6-86"	25mm, 50mm, 100mm, 200mm, 400mm (4 pcs)
3635-3150	150-3150mm/6-126"	25mm, 50mm, 100mm, 200mm (2 pcs), 400mm, 1000mm (2 pcs)
3635-4150	150-4150mm/6-166"	25mm, 50mm, 100mm, 200mm (2 pcs), 400mm, 1000mm (3 pcs)
3635-5150	150-5150mm/6-206"	25mm, 50mm, 100mm, 200mm (2 pcs), 400mm, 1000mm (4 pcs)
3635-6150	150-6150mm/6-246"	25mm, 50mm, 100mm, 200mm (2 pcs), 400mm, 1000mm (5 pcs)

INTERNAL GEAR TOOTH MICROMETERS

INSIZE PLUS
MADE IN EUROPE



3638-200

- Measure over-pin diameter of gears
- Points of extension rods are spring loaded
- Optional accessory: ball tips (code 7383)

Micrometer head

Range	Graduation	Accuracy
100-115mm	0.01mm	±4µm
150-175mm	0.01mm	±4µm

Extension rod

Length (L)	Accuracy
15mm	±1µm
25mm	±1.25µm
30mm	±1.25µm
50mm	±1.25µm
100mm	±2µm
200mm	±3.5µm
400mm	±4.5µm

Code	Range	Micrometer head	Extension rod (L)
3638-200	100-205mm	100-115mm	15mm, 25mm, 50mm
3638-500	100-505mm	100-115mm	15mm, 25mm, 50mm, 100mm, 200mm
3638-900	100-905mm	100-115mm	15mm, 25mm, 50mm, 100mm, 200mm, 400mm
3638-1100	150-1150mm	150-175mm	25mm, 50mm, 100mm, 200mm, 200mm, 400mm

INTERNAL SCREW THREAD MICROMETERS

INSIZE PLUS
MADE IN EUROPE



3641-200

- Measure pitch diameter of screw thread
- Points of extension rods are spring loaded
- Optional accessory: measuring tips for internal screw thread micrometer (code 7385, L=13.5mm)

Micrometer head

Range	Graduation	Accuracy
100-115mm	0.01mm	±4µm
150-175mm	0.01mm	±4µm

Extension rod

Length (A)	Accuracy
15mm	±1µm
25mm	±1.25µm
50mm	±1.25µm
100mm	±2µm
200mm	±3.5µm
400mm	±4.5µm

Code	Range	Micrometer head	Extension rod (A)	Applicable tips
3641-200	100-205mm	100-115mm	15mm, 25mm, 50mm	stem length L=13.5mm
3641-500	100-505mm	100-115mm	15mm, 25mm, 50mm, 100mm, 200mm	stem length L=13.5mm
3641-900	100-905mm	100-115mm	15mm, 25mm, 50mm, 100mm, 200mm, 400mm	stem length L=13.5mm
3641-1100	150-1150mm	150-175mm	25mm, 50mm, 100mm, 200mm, 200mm, 400mm	stem length L=13.5mm

TIPS FOR TRAPEZOIDAL, ACME
THREAD ARE ALSO AVAILABLE

MEASURING TIPS FOR INTERNAL SCREW THREAD MICROMETERS

INSIZE PLUS
MADE IN EUROPE

- Supplied in pair
- Made of hardened steel
- Suitable for **3641** series micrometers



7385-T106A

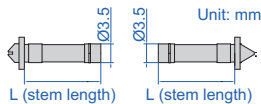

7385-T106B

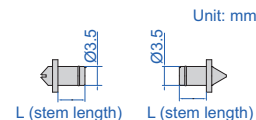

60° thread angle

Code		Applicable pitch (mm)
L=13.5mm	L=5mm	
7385-T101A	7385-T101B	0.35
7385-T102A	7385-T102B	0.4/0.45
7385-T103A	7385-T103B	0.5/0.6
7385-T104A	7385-T104B	0.7/0.75/0.8
7385-T105A	7385-T105B	1/1.25
7385-T106A	7385-T106B	1.5/1.75
7385-T107A	7385-T107B	2.0/2.5
7385-T108A	7385-T108B	3.0/3.5
7385-T109A	7385-T109B	4.0/4.5/5.0
7385-T110A	7385-T110B	5.5/6.0

55° thread angle

Code		Applicable pitch (TPI)
L=13.5mm	L=5mm	
7385-T201A	7385-T201B	60/48
7385-T202A	7385-T202B	40/32
7385-T203A	7385-T203B	28/26/24/22
7385-T204A	7385-T204B	20/19/18/16
7385-T205A	7385-T205B	14/12/11
7385-T206A	7385-T206B	10/9/8
7385-T207A	7385-T207B	7/6
7385-T208A	7385-T208B	5/4.5/4
7385-T209A	7385-T209B	3.5/3.25/3/2.875/2.75
7385-T210A	7385-T210B	2.625/2.5/2

INTERNAL SCREW THREAD MICROMETERS

- Graduation: 0.01mm
- Optional accessory: measuring tips for internal screw thread micrometer (code 7321)



measuring tips for screw thread (optional)

measuring tips for screw thread (optional)

3226-1001

measuring tips for internal screw thread micrometer (optional)



Code	Range	Code	Range
3226-1001	75-100mm	3226-2251	200-225mm
3226-1251	100-125mm	3226-2501	225-250mm
3226-1501	125-150mm	3226-2751	250-275mm
3226-1751	150-175mm	3226-3001	275-300mm
3226-2001	175-200mm		

MEASURING TIPS FOR INTERNAL SCREW THREAD MICROMETERS

- Supplied in pair
- Suitable for **3226** series micrometers

Metric and unified screw (60° thread angle)

Code	Pitch
7321-T11	0.4-0.5mm/64-48TPI
7321-T12	0.6-0.9mm/44-28TPI
7321-T13	1-1.75mm/24-14TPI
7321-T14	2-3mm/13-9TPI
7321-T15	3.5-5mm/8-5TPI
7321-T16	5.5-7mm/4.5-3.5TPI
7321-T1S	6 pairs/set, including all above tips



7321-T1S

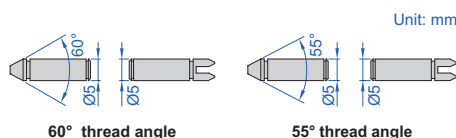

60° thread angle

55° thread angle

Whitworth screw (55° thread angle)

Code	Pitch
7321-T21	60-48TPI
7321-T22	48-40TPI
7321-T23	40-32TPI
7321-T24	32-24TPI
7321-T25	24-18TPI
7321-T26	18-14TPI
7321-T27	14-10TPI
7321-T28	10-7TPI
7321-T29	7-4.5TPI
7321-T210	4.5-3.5TPI
7321-T2S	10 pairs/set, including all above tips

TWO POINTS/THREE POINTS INTERNAL MICROMETERS

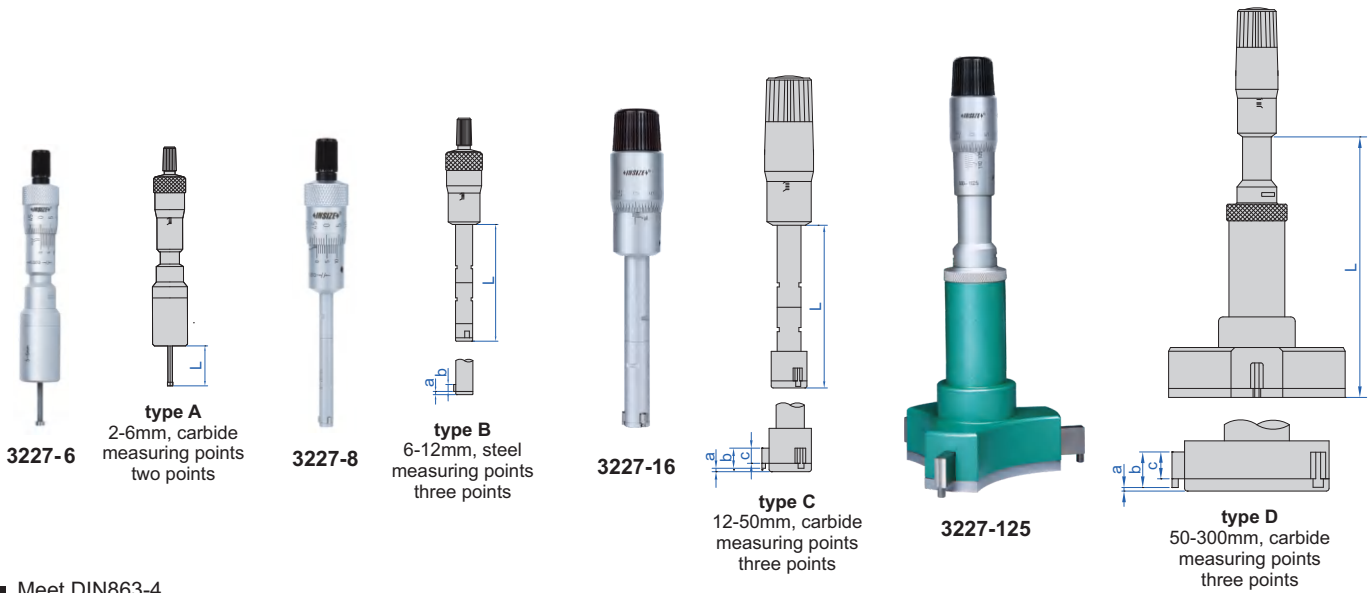

- Meet DIN863-4
- 2-12mm: graduation 0.001mm
12-300mm: graduation 0.005mm
- Ratchet stop
- Optional accessory: setting rings (code **6312**), micrometer stand and clamp (code **6301** and **6301-2**)

Individual

(mm)

Code	Range	Type	Accuracy	Setting ring	Extension rod (included)	L	a	b	c
3227-2 *	2-2.5mm	A (two points)	6µm	Ø2.5 (included)	—	12	—	—	—
3227-3 *	2.5-3mm	A (two points)	6µm	Ø2.5 (included)	—	12	—	—	—
3227-4 *	3-4mm	A (two points)	6µm	Ø4 (included)	—	22	—	—	—
3227-5 *	4-5mm	A (two points)	6µm	Ø5 (included)	—	22	—	—	—
3227-6 *	5-6mm	A (two points)	6µm	Ø6 (included)	—	22	—	—	—
3227-8 *	6-8mm	B (three points)	4µm	Ø6 (included)	100	54.5	1.5	2.5	—
3227-10 *	8-10mm	B (three points)	4µm	Ø8 (included)	100	54.5	1.5	2.5	—
3227-12 *	10-12mm	B (three points)	4µm	Ø10 (included)	100	54.5	1.5	2.5	—
3227-16 *	12-16mm	C (three points)	4µm	Ø16 (included)	150	80	0.5	6	4.5
3227-20 *	16-20mm	C (three points)	4µm	Ø16 (included)	150	80	0.5	6	4.5
3227-25 *	20-25mm	C (three points)	4µm	Ø25 (included)	150	90	0.5	8	6
3227-30 *	25-30mm	C (three points)	4µm	Ø25 (included)	150	90	0.5	8	6
3227-40 *	30-40mm	C (three points)	4µm	Ø40 (included)	150	97	0.5	14	12
3227-50 *	40-50mm	C (three points)	5µm	Ø40 (included)	150	97	0.5	14	12
3227-63 *	50-63mm	D (three points)	5µm	Ø62 (included)	150	114	0.5	17.5	14.5
3227-75 *	62-75mm	D (three points)	5µm	Ø62 (included)	150	114	0.5	17.5	14.5
3227-88 *	75-88mm	D (three points)	5µm	Ø87 (included)	150	114	0.5	17.5	14.5
3227-100 *	87-100mm	D (three points)	5µm	Ø87 (included)	150	114	0.5	17.5	14.5
3227-125 *	100-125mm	D (three points)	6µm	optional	150	140	0.9	29	25
3227-150 *	125-150mm	D (three points)	6µm	optional	150	140	0.9	29	25
3227-175 *	150-175mm	D (three points)	7µm	optional	150	140	0.9	29	25
3227-200 *	175-200mm	D (three points)	7µm	optional	150	140	0.9	29	25
3227-225	200-225mm	D (three points)	8µm	optional	150	140	0.9	29	25
3227-250	225-250mm	D (three points)	8µm	optional	150	140	0.9	29	25
3227-275	250-275mm	D (three points)	9µm	optional	150	140	0.9	29	25
3227-300	275-300mm	D (three points)	9µm	optional	150	140	0.9	29	25

To be continued

Continued from previous page



micrometer stand with clamp (optional)



setting ring

2-100mm: included
100-300mm: optional

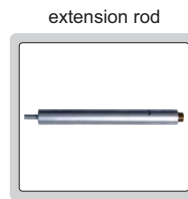

extension rod

included



3227-504

Set

Code	Range	Micrometers included	Setting ring (included)	Extension rod (included)
3227-232 *	2-3mm	2-2.5mm, 2.5-3mm	Ø2.5mm	—
3227-363 *	3-6mm	3-4mm, 4-5mm, 5-6mm	Ø4mm, Ø5mm, Ø6mm	—
3227-123 *	6-12mm	6-8mm, 8-10mm, 10-12mm	Ø6mm, Ø8mm, Ø10mm	100mm
3227-202 *	12-20mm	12-16mm, 16-20mm	Ø16mm	150mm
3227-504 *	20-50mm	20-25mm, 25-30mm, 30-40mm, 40-50mm	Ø25mm, Ø40mm	150mm
3227-1004 *	50-100mm	50-63mm, 62-75mm, 75-88mm, 87-100mm	Ø62mm, Ø87mm	150mm

* Supplied with manufacturer inspection certificate

IP65
WATERPROOF

DATA
OUTPUT

DIGITAL TWO POINTS/THREE POINTS INTERNAL MICROMETERS

INSPECTION
CERTIFICATE



3127-5

type A
2-6mm, carbide
measuring points
two points



3127-12

type B
6-12mm, steel
measuring points
three points



3127-40

type C
12-50mm, carbide
measuring points
three points



3127-125

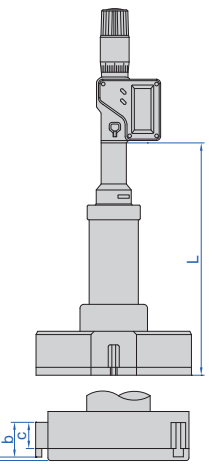

type D
50-300mm, carbide
measuring points
three points

- Resolution 0.001mm/0.00005" (resolution of 3127-275 and 3127-300 is 0.001mm/0.0001")
- IP65 dust/waterproof
- Buttons: on/off, set, mm/inch, data transmit
- Data output
- Automatic power off
- Ratchet stop
- Optional accessory: wireless transmitter code 7315-31 (receiver is needed) page 6, bluetooth transmitter code 7214-31 page 12, data output cable code 7302-31 page 20, setting ring (code 6312), micrometer stand and clamp (code 6301 and 6301-2)

To be continued

Continued from previous page

micrometer stand with clamp (optional)



setting ring



2-100mm: included
100-300mm: optional

extension rod

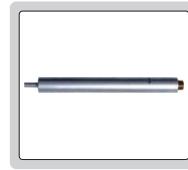

included



3127-202

7

Individual

(mm)

Code	Range	Type	Accuracy	Setting ring	Extension rod (included)	L	a	b	c
3127-2*	2-2.5mm/0.08-0.10"	A (two points)	6µm	Ø2.5 (included)	—	12	—	—	—
3127-3*	2.5-3mm/0.10-0.12"	A (two points)	6µm	Ø2.5 (included)	—	12	—	—	—
3127-4*	3-4mm/0.12-0.16"	A (two points)	6µm	Ø4 (included)	—	22	—	—	—
3127-5*	4-5mm/0.16-0.20"	A (two points)	6µm	Ø5 (included)	—	22	—	—	—
3127-6*	5-6mm/0.20-0.24"	A (two points)	6µm	Ø6 (included)	—	22	—	—	—
3127-8*	6-8mm/0.24-0.31"	B (three points)	4µm	Ø6 (included)	100	57	1.5	2.5	—
3127-10*	8-10mm/0.31-0.39"	B (three points)	4µm	Ø8 (included)	100	57	1.5	2.5	—
3127-12*	10-12mm/0.39-0.47"	B (three points)	4µm	Ø10 (included)	100	57	1.5	2.5	—
3127-16*	12-16mm/0.47-0.63"	C (three points)	4µm	Ø16 (included)	150	99	0.5	6	4.5
3127-20*	16-20mm/0.63-0.79"	C (three points)	4µm	Ø16 (included)	150	99	0.5	6	4.5
3127-25*	20-25mm/0.79-0.98"	C (three points)	4µm	Ø25 (included)	150	105	0.5	8	6
3127-30*	25-30mm/0.98-1.18"	C (three points)	4µm	Ø25 (included)	150	105	0.5	8	6
3127-40*	30-40mm/1.18-1.57"	C (three points)	4µm	Ø40 (included)	150	110	0.5	14	12
3127-50*	40-50mm/1.57-1.97"	C (three points)	5µm	Ø40 (included)	150	110	0.5	14	12
3127-63*	50-63mm/1.97-2.48"	D (three points)	5µm	Ø62 (included)	150	127	0.5	17.5	14.5
3127-75*	62-75mm/2.44-2.95"	D (three points)	5µm	Ø62 (included)	150	127	0.5	17.5	14.5
3127-88*	75-88mm/2.95-3.46"	D (three points)	5µm	Ø87 (included)	150	127	0.5	17.5	14.5
3127-100*	87-100mm/3.43-3.94"	D (three points)	5µm	Ø87 (included)	150	127	0.5	17.5	14.5
3127-125*	100-125mm/3.94-4.92"	D (three points)	6µm	optional	150	175	0.9	29	25
3127-150*	125-150mm/4.92-5.91"	D (three points)	6µm	optional	150	175	0.9	29	25
3127-175*	150-175mm/5.91-6.89"	D (three points)	7µm	optional	150	175	0.9	29	25
3127-200*	175-200mm/6.89-7.87"	D (three points)	7µm	optional	150	175	0.9	29	25
3127-225	200-225mm/7.87-8.86"	D (three points)	8µm	optional	150	175	0.9	29	25
3127-250	225-250mm/8.86-9.84"	D (three points)	8µm	optional	150	175	0.9	29	25
3127-275	250-275mm/9.84-10.83"	D (three points)	9µm	optional	150	175	0.9	29	25
3127-300	275-300mm/10.83-11.81"	D (three points)	9µm	optional	150	175	0.9	29	25

Set

Code	Range	Micrometers included	Setting ring (included)	Extension rod (included)
3127-232*	2-3mm/0.08-0.12"	2-2.5mm, 2.5-3mm	Ø2.5mm	—
3127-363*	3-6mm/0.12-0.24"	3-4mm, 4-5mm, 5-6mm	Ø4mm, Ø5mm, Ø6mm	—
3127-123*	6-12mm/0.24-0.47"	6-8mm, 8-10mm, 10-12mm	Ø6mm, Ø8mm, Ø10mm	100mm
3127-202*	12-20mm/0.47-0.79"	12-16mm, 16-20mm	Ø16mm	150mm
3127-504*	20-50mm/0.79-1.97"	20-25mm, 25-30mm, 30-40mm, 40-50mm	Ø25mm, Ø40mm	150mm
3127-1004*	50-100mm/1.97-3.94"	50-63mm, 62-75mm, 75-88mm, 87-100mm	Ø62mm, Ø87mm	150mm

*Supplied with manufacturer inspection certificate



WIDE RANGE THREE POINTS INTERNAL MICROMETERS

- Meet DIN863-4
- Graduation 0.001mm
- Carbide measuring faces
- Ratchet stop
- Setting rings are included (except 200-300mm)



3228-70

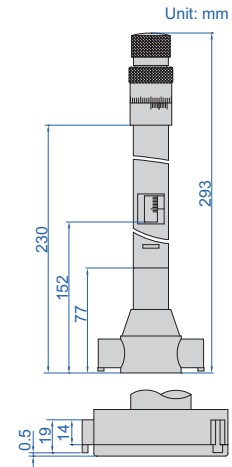

setting ring

Code	Range	Accuracy	Setting ring
3228-70*	50-70mm	5µm	Ø50mm (included)
3228-100*	70-100mm	5µm	Ø70mm (included)
3228-150*	100-150mm	6µm	Ø100mm (included)
3228-250*	150-250mm	8µm	Ø150mm (included)
3228-300*	200-300mm	9µm	Ø200mm (optional)

*Supplied with manufacturer inspection certificate

IP54
WATERPROOF

DATA
OUTPUT

DIGITAL WIDE RANGE THREE POINTS INTERNAL MICROMETERS



- Meet DIN863-4
- Resolution 0.001mm/0.00005" (resolution of 3128-300 is 0.001mm/0.0001")
- IP54 dust/waterproof
- Buttons: on/off, set, mm/inch
- Data output
- Automatic power off
- Carbide measuring faces
- Ratchet stop
- Supplied with extension rods
- Setting rings are included (except 200-300mm)
- Optional accessory: wireless transmitter code 7315-30 (receiver is needed) page 5, bluetooth transmitter code 7214-30 page 11, data output cable code 7302-30 page 20



3128-150

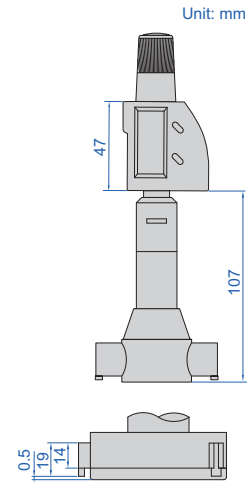

setting ring



extension rod (included)

Code	Range	Accuracy	Setting ring	Extension rod (included)
3128-70*	50-70mm/1.97-2.76"	5µm	Ø50mm (included)	150mm
3128-100*	70-100mm/2.76-3.94"	5µm	Ø70mm (included)	150mm
3128-150*	100-150mm/3.94-5.91"	6µm	Ø100mm (included)	150mm
3128-250*	150-250mm/5.91-9.84"	8µm	Ø150mm (included)	150mm
3128-300*	200-300mm/7.87-11.81"	9µm	Ø200mm (optional)	150mm

*Supplied with manufacturer inspection certificate

DIGITAL WIDE RANGE THREE POINTS INTERNAL MICROMETER

IP54
WATERPROOF

DATA
OUTPUT

7

extension rod (included)



50mm replaceable measuring jaws (included)



100mm replaceable measuring jaws (included)



3621-500

Unit: mm

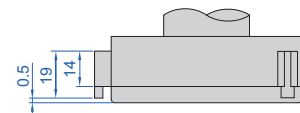
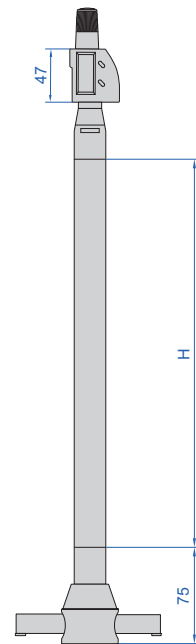

- Resolution 0.001mm/0.0001" (resolution is 0.00005" when <10")
- Replaceable measuring jaws, wide measuring range
- Buttons: on/off, set, mm/inch
- Data output
- Automatic power off
- Carbide measuring faces
- Ratchet stop
- Supplied with extension rods
- Optional accessory: setting rings (code **6312-200**, **6312-300**, **6312-400**), wireless transmitter code **7315-30** (receiver is needed) page 5, bluetooth transmitter code **7214-30** page 11, data output cable code **7302-30** page 20

Code	Range	Accuracy	Measuring jaws (included)	Extension rods H (included)
3621-500	200-500mm/7.87-19.69"	(1+L/50) μm *	50mm (3pcs), 100mm (3pcs)	150mm, 500mm

*L=maximum measuring diameter (mm)



PISTOL GRIP THREE POINTS BORE GAUGES

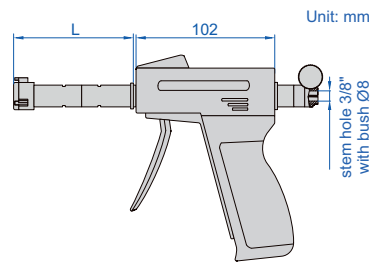

- Optional accessory: digital indicators (code **2103-101F**, resolution 0.001mm/0.00005"), setting rings (code **6312**)

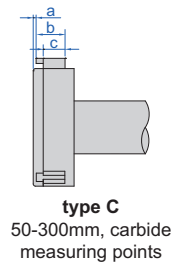
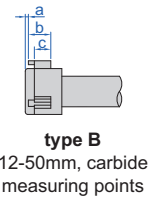
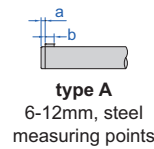
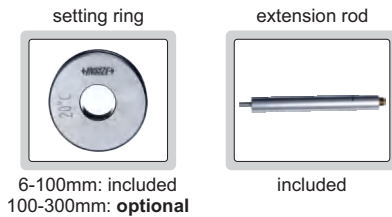

Individual

(mm)

Code	Range	Type	Accuracy (without digital indicator)	Setting ring	Extension rod (included)	L	a	b	c
2124-8 *	6-8mm	A	4µm	Ø6mm (included)	100mm	50	1.5	2.5	—
2124-10 *	8-10mm	A	4µm	Ø8mm (included)	100mm	50	1.5	2.5	—
2124-12 *	10-12mm	A	4µm	Ø10mm (included)	100mm	50	1.5	2.5	—
2124-16 *	12-16mm	B	4µm	Ø16mm (included)	150mm	65	0.5	6	4.5
2124-20 *	16-20mm	B	4µm	Ø16mm (included)	150mm	65	0.5	6	4.5
2124-25 *	20-25mm	B	4µm	Ø25mm (included)	150mm	91	0.5	8	6
2124-30 *	25-30mm	B	4µm	Ø25mm (included)	150mm	91	0.5	8	6
2124-40 *	30-40mm	B	4µm	Ø40mm (included)	150mm	97	0.5	14	12
2124-50 *	40-50mm	B	5µm	Ø40mm (included)	150mm	97	0.5	14	12
2124-63 *	50-63mm	C	5µm	Ø62mm (included)	150mm	112	0.5	17.5	14.5
2124-75 *	62-75mm	C	5µm	Ø62mm (included)	150mm	112	0.5	17.5	14.5
2124-88 *	75-88mm	C	5µm	Ø87mm (included)	150mm	112	0.5	17.5	14.5
2124-100 *	87-100mm	C	5µm	Ø87mm (included)	150mm	112	0.5	17.5	14.5
2124-125 *	100-125mm	C	6µm	optional	150mm	140	0.9	29	25
2124-150 *	125-150mm	C	6µm	optional	150mm	140	0.9	29	25
2124-175 *	150-175mm	C	7µm	optional	150mm	140	0.9	29	25
2124-200 *	175-200mm	C	7µm	optional	150mm	140	0.9	29	25
2124-225	200-225mm	C	8µm	optional	150mm	140	0.9	29	25
2124-250	225-250mm	C	8µm	optional	150mm	140	0.9	29	25
2124-275	250-275mm	C	9µm	optional	150mm	140	0.9	29	25
2124-300	275-300mm	C	9µm	optional	150mm	140	0.9	29	25

Set

Code	Range	Probes included	Setting ring (included)	Extension rod (included)
2124-S123 *	6-12mm	6-8mm, 8-10mm, 10-12mm	Ø6mm, Ø8mm, Ø10mm	100mm
2124-S202 *	12-20mm	12-16mm, 16-20mm	Ø16mm	150mm
2124-S504 *	20-50mm	20-25mm, 25-30mm, 30-40mm, 40-50mm	Ø25mm, Ø40mm	150mm
2124-S1004 *	50-100mm	50-63mm, 62-75mm, 75-88mm, 87-100mm	Ø62mm, Ø87mm	150mm



2124-S504

* Supplied with manufacturer inspection certificate

BORE PLUG GAUGES

INSIZE PLUS
MADE IN EUROPE

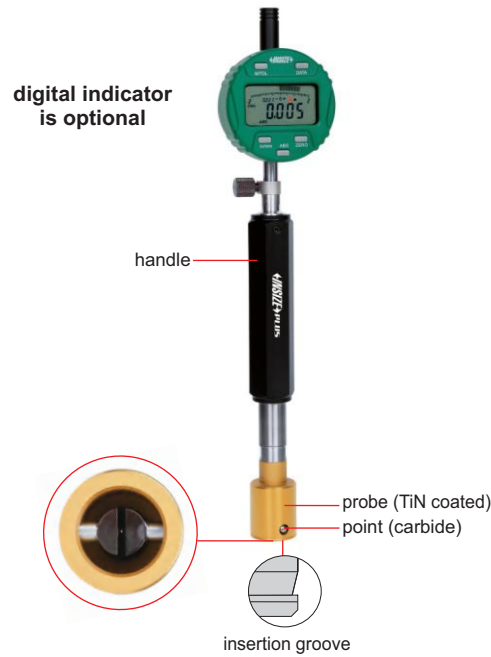

7

principle of measurement

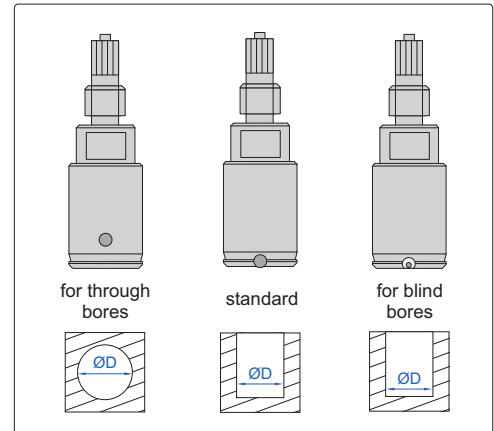
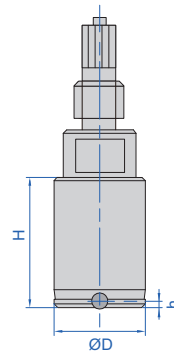
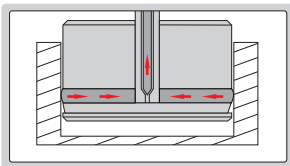

- TiN coating provides very good hardness (2200 HV), corrosion resistance with outstanding sliding and friction characteristics

SPECIFICATION OF PROBE

(mm)

Range (ØD)		6-8 *	8-10	10-20	20-50	50-100	100-130	130-280
Travel of point (s)		0.15	0.15	0.15	0.20	0.20	0.20	0.20
Thread		M6×0.75			M10×1			
Height of point (h)	for through bores	5	5	5	6	7.5	10	10
	standard	1.6	1.6	1.6	2.5	2.5	2.5	2.5
	for blind bores	/	/	0.6	1.2	1.2	1.2	/
Height of probe (H)	for through bores	27	27	27	29	33.5	36	36
	standard	23.5	23.5	23.5	25.5	28.5	28.5	28.5
	for blind bores	/	/	23.5	25.5	28.5	28.5	/
Repeatability		0.001						

* When measuring range is 6-8mm, we suggest to use Ø7.5mm extension rod;
When measuring range is 6-8mm, it has insertion chamfer for self-centering

To be continued

Continued from previous page



PROBE

Code	Type
4683-NO□□□□	for through bores
4683-XK□□□□	standard
4683-SL□□□□	for blind bores

SETTING RING

Code
6312-□□□□□

Ordering examples:

Code	Type	Range
4683-NO38D10H7	for through bores	38.10H7

Attention: "D" stands for "."

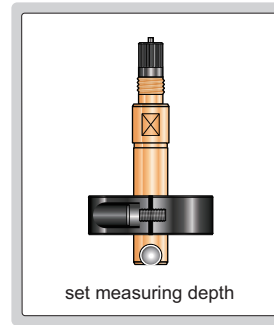

4683-G

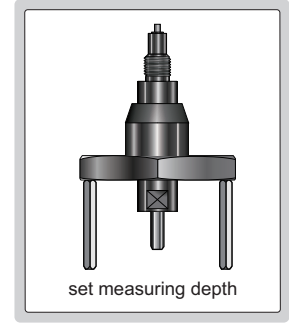

4683-J

DEPTH STOP

Code	Applicable for probe
4683-G□□□□□	6.0~85mm
4683-J□□□□□	28~150mm

Ordering examples:

Code	Applicable for probe
4683-G22H7	22H7



HANDLE

Code	Length (L)	Diameter (ØD)	Thread
4683-HM50S	50mm	8mm	M6×0.75
4683-HM100S	100mm	8mm	M6×0.75
4683-HM150S*	150mm	8mm	M6×0.75
4683-HM60	60mm	15mm	M10×1
4683-HM150*	150mm	15mm	M10×1

* The length 150mm handle is made of temperature-stable steel



EXTENSION ROD FOR HANDLE

Code	Length (L)	Diameter (ØD)	Thread
4683-VL65T	65mm	7.5mm	M6×0.75
4683-VL50S	50mm	8mm	M6×0.75
4683-VL100S*	100mm	8mm	M6×0.75
4683-VL150S*	150mm	8mm	M6×0.75
4683-VL250S*	250mm	8mm	M6×0.75
4683-VL50	50mm	15mm	M10×1
4683-VL100*	100mm	15mm	M10×1
4683-VL150*	150mm	15mm	M10×1
4683-VL250*	250mm	15mm	M10×1

* The length 100mm, 150mm and 250mm are made of temperature-stable steel

90° ADAPTER

Code	Thread
4683-WS1	M6×0.75
4683-WS2	M10×1

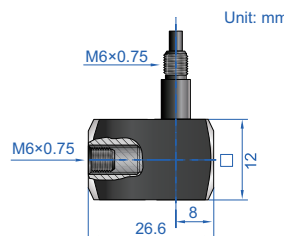

4683-WS1

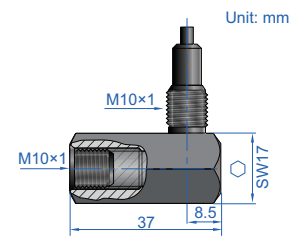

4683-WS2

PRECISION BORE GAUGES FOR SMALL HOLES (WITHOUT DIAL INDICATOR)

digital indicator
is optional



2284-10

digital indicator
is optional



2284-18

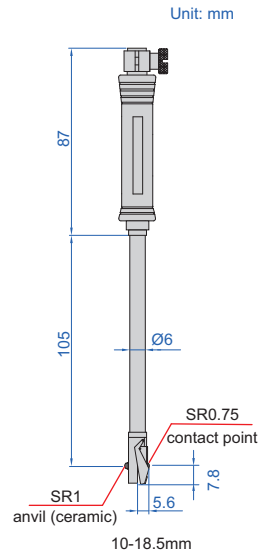
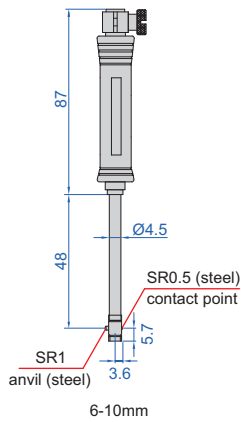

Unit: mm

Optional accessory:
dial indicator, bore gauge setter, setting ring (code **6312**)

Code	Range	Accuracy (without dial comparator)	Repeatability (without dial comparator)
2284-10	6-10mm	±0.004mm	0.0015mm
2284-18	10-18.5mm	±0.004mm	0.0015mm



PRECISION BORE GAUGES FOR SMALL HOLES (WITH DIAL INDICATOR)

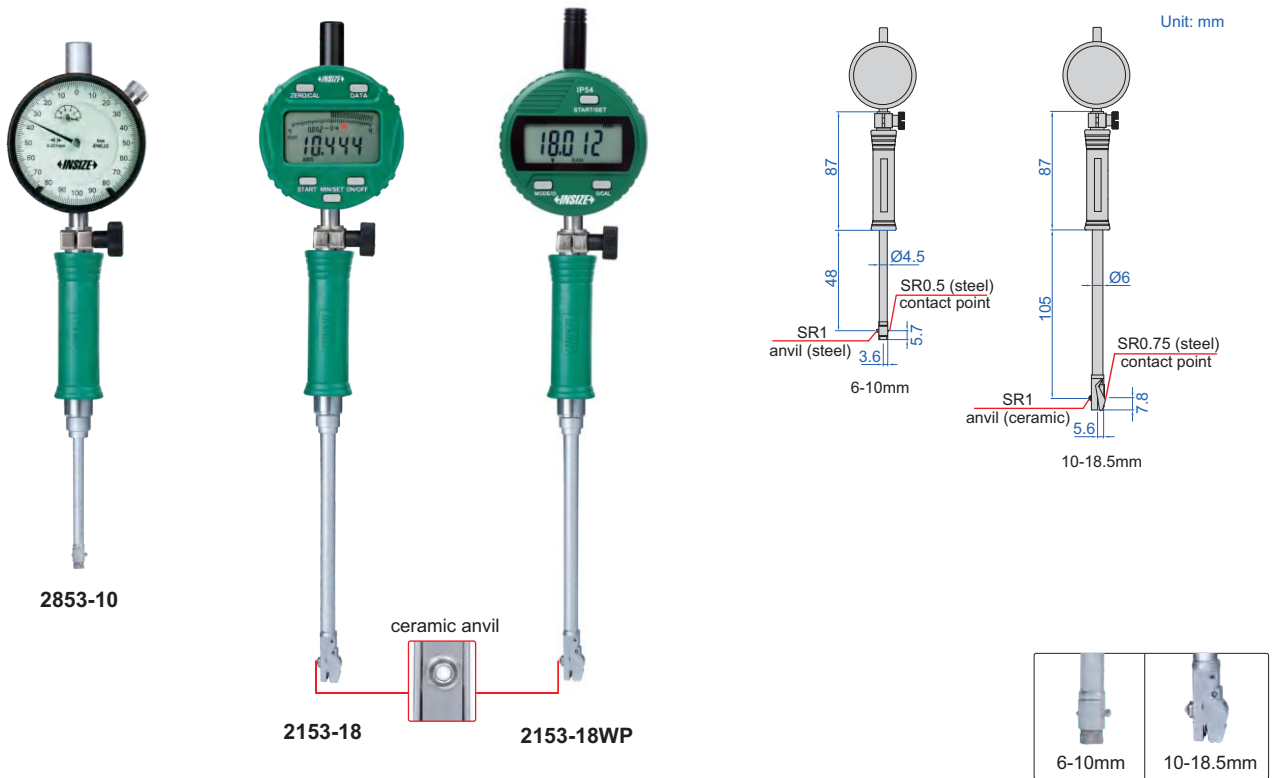

- Optional accessory: setting ring (code 6312), bore gauge setter

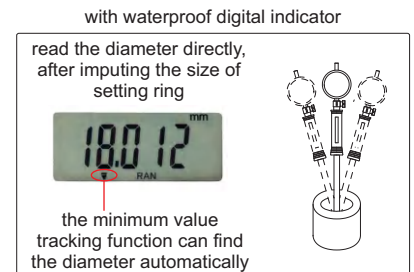
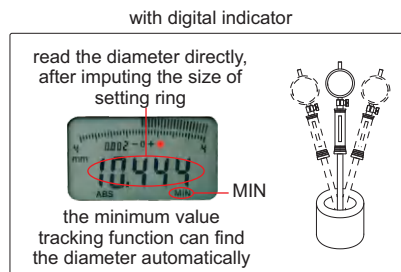

With dial indicator

Code	Range	Indicator	Accuracy	Repeatability
2853-10	6-10mm	dial indicator, range 1mm,	±0.007mm	0.0015mm
2853-18	10-18.5mm	graduation 0.001mm (code 2313-1FA)	±0.007mm	0.0015mm

With digital indicator (optional data output cable: code 7315-51B receiver is needed page 7, 7214-51B page 12, 7302-40M page 21)

Code	Range	Indicator	Accuracy	Repeatability
2153-10	6-10mm	digital indicator, code 2108-101F, range 12.7mm/0.5", resolution 0.001mm/0.00005"	±0.007mm	0.002mm
2153-18	10-18.5mm		±0.007mm	0.002mm

With waterproof digital indicator (optional data output cable: code 7315-51B receiver is needed page 7, 7214-51B page 12, 7302-40M page 21)

Code	Range	Indicator	Accuracy	Repeatability
2153-10WP	6-10mm	waterproof digital indicator, code 2137-101F, range 12.7mm/0.5", dust/waterproof IP54, resolution 0.001mm/0.00005"	±0.007mm	0.002mm
2153-18WP	10-18.5mm		±0.007mm	0.002mm

BORE GAUGES FOR SMALL HOLES (WITH DIAL INDICATOR)

ATTENTION: NOT SUITABLE FOR 0.001MM DIAL INDICATORS



2852-10



2152-18

2152-18WP

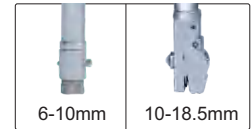
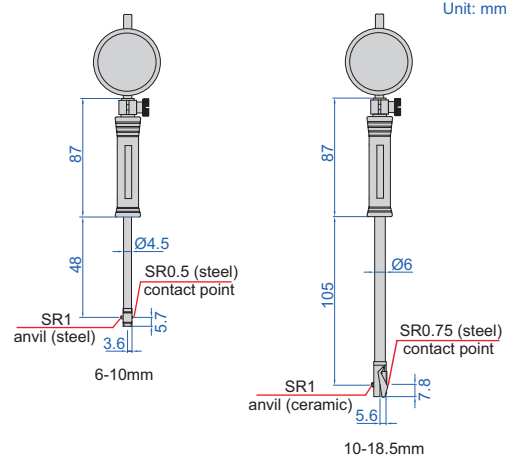

7

- Optional accessory: setting ring (code 6312), bore gauge setter

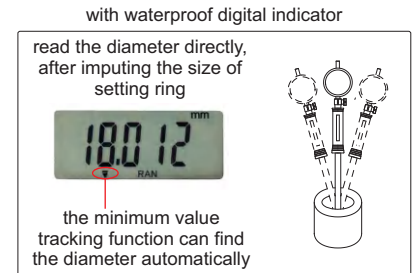
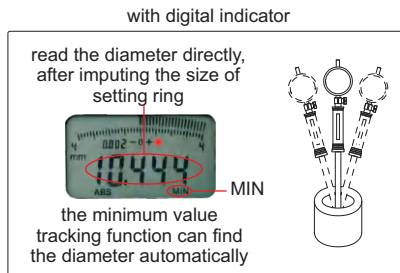

With dial indicator

Code	Range	Indicator	Accuracy	Repeatability
2852-10	6-10mm	dial indicator, range 3mm,	±0.012mm	0.003mm
2852-18	10-18.5mm	graduation 0.01mm (code 2311-3F)	±0.012mm	0.003mm

With digital indicator (optional data output cable: code 7315-51B receiver is needed page 7, 7214-51B page 12, 7302-40M page 21)

Code	Range	Indicator	Accuracy	Repeatability
2152-10	6-10mm	digital indicator, code 2108-10F, range 12.7mm/0.5", resolution 0.002mm/0.0001"	±0.012mm	0.003mm
2152-18	10-18.5mm	(can switch to 0.01mm/0.0005")	±0.012mm	0.003mm

With waterproof digital indicator (optional data output cable: code 7315-51B receiver is needed page 7, 7214-51B page 12, 7302-40M page 21)

Code	Range	Indicator	Accuracy	Repeatability
2152-10WP	6-10mm	waterproof digital indicator, code 2137-10F, range 12.7mm/0.5", dust/waterproof IP54, resolution 0.002mm/0.0001"	±0.012mm	0.003mm
2152-18WP	10-18.5mm	(can switch to 0.01mm/0.0005")	±0.012mm	0.003mm

PRECISION BORE GAUGES (WITHOUT DIAL INDICATOR)

digital indicator
is optional



2283-35

digital indicator
is optional



2283-160

- Optional accessory: dial indicator, setting ring (code 6312), bore gauge setter

Range	A	B	C	ØD	ØE	F	L
35-60mm	22	9	27	13	12.8	SR2	141
50-100mm	26	9	35	13	12.8	SR2	141
50-160mm	26	9	35	13	12.8	SR2	141
100-160mm	26	9	35	13	12.8	SR2	141
160-250mm	56.5	13	74.5	15	14.5	SR2	241
250-450mm	86.5	15	101.5	15	14.5	SR2.5	241

(mm)

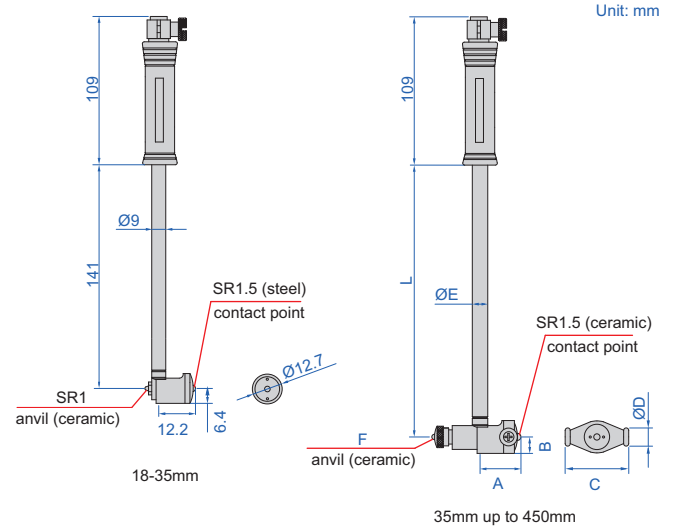

Code	Range	Accuracy (without dial comparator)	Repeatability (without dial comparator)
2283-35	18-35mm	±0.004mm	0.0015mm
2283-60	35-60mm	±0.004mm	0.0015mm
2283-100	50-100mm	±0.004mm	0.0015mm
2283-160	50-160mm	±0.004mm	0.0015mm
2283-161	100-160mm	±0.004mm	0.0015mm
2283-250	160-250mm	±0.004mm	0.0015mm
2283-450	250-450mm	±0.004mm	0.0015mm

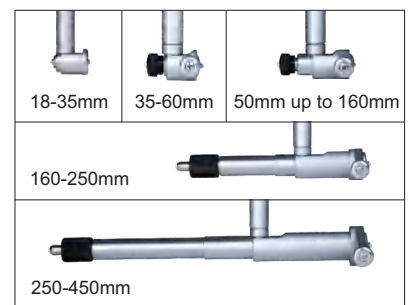

PRECISION BORE GAUGES (WITH DIAL INDICATOR)

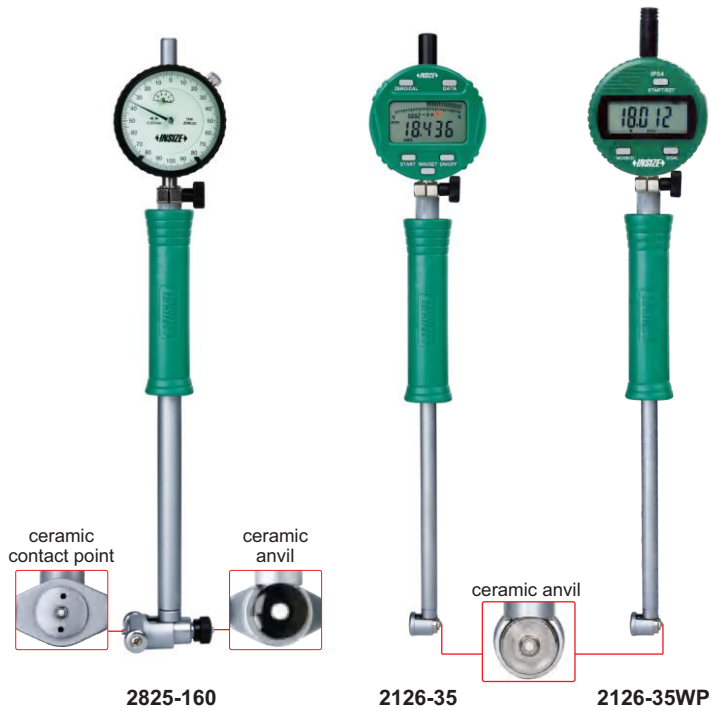
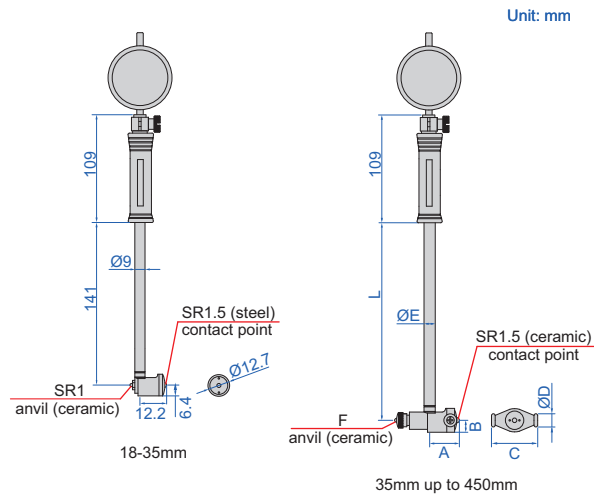

- Optional accessory: setting ring (code 6312), bore gauge setter

Range	A	B	C	ØD	ØE	F	L
35-60mm	22	9	27	13	12.8	SR2	141
50-100mm	26	9	35	13	12.8	SR2	141
50-160mm	26	9	35	13	12.8	SR2	141
100-160mm	26	9	35	13	12.8	SR2	141
160-250mm	56.5	13	74.5	15	14.5	SR2	241
250-450mm	86.5	15	101.5	15	14.5	SR2.5	241

With dial indicator

Code	Range	Indicator	Accuracy	Repeatability
2825-35	18-35mm	dial indicator, range 1mm, graduation 0.001mm (code 2313-1FA)	±0.007mm	0.0015mm
2825-60	35-60mm		±0.007mm	0.0015mm
2825-100	50-100mm		±0.007mm	0.0015mm
2825-160	50-160mm		±0.007mm	0.0015mm
2825-161	100-160mm		±0.007mm	0.0015mm
2825-250	160-250mm		±0.007mm	0.0015mm
2825-450	250-450mm		±0.007mm	0.0015mm

With digital indicator (optional data output cable: code 7315-51B receiver is needed page 7, 7214-51B page 12, 7302-40M page 21)

Code	Range	Indicator	Accuracy	Repeatability
2126-35	18-35mm	digital indicator, code 2108-101F, range 12.7mm/0.5", resolution 0.001mm/0.00005"	±0.007mm	0.002mm
2126-60	35-60mm		±0.007mm	0.002mm
2126-100	50-100mm		±0.007mm	0.002mm
2126-160	50-160mm		±0.007mm	0.002mm
2126-161	100-160mm		±0.007mm	0.002mm
2126-250	160-250mm		±0.007mm	0.002mm
2126-450	250-450mm		±0.007mm	0.002mm

With waterproof digital indicator (optional data output cable: code 7315-51B receiver is needed page 7, 7214-51B page 12, 7302-40M page 21)

Code	Range	Indicator	Accuracy	Repeatability
2126-35WP	18-35mm	waterproof digital indicator, code 2137-101F, range 12.7mm/0.5", dust/waterproof IP54, resolution 0.001mm/0.00005"	±0.007mm	0.002mm
2126-60WP	35-60mm		±0.007mm	0.002mm
2126-100WP	50-100mm		±0.007mm	0.002mm
2126-160WP	50-160mm		±0.007mm	0.002mm
2126-161WP	100-160mm		±0.007mm	0.002mm
2126-250WP	160-250mm		±0.007mm	0.002mm
2126-450WP	250-450mm		±0.007mm	0.002mm

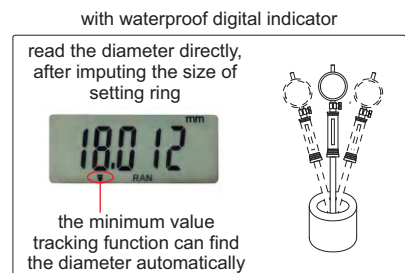
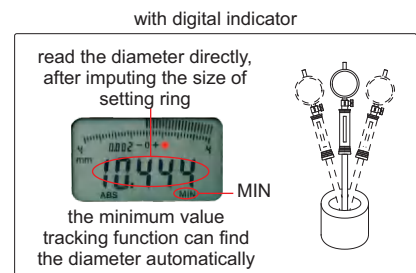
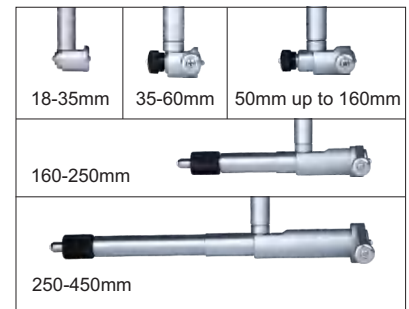



POPULAR MODEL

ATTENTION: NOT SUITABLE FOR 0.001MM DIAL INDICATORS

BORE GAUGES (WITH DIAL INDICATOR)

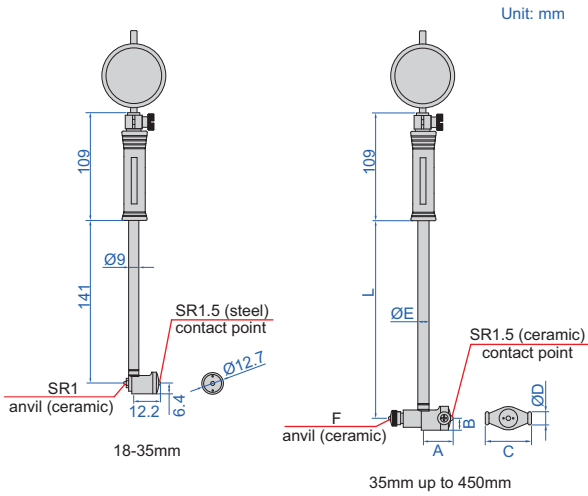

- Optional accessory: setting ring (code **6312**), long handle (code **7351**), bore gauge setter

Range	A	B	C	ØD	ØE	F	L
35-60mm	22	9	27	13	12.8	SR2	141
50-100mm	26	9	35	13	12.8	SR2	141
50-160mm	26	9	35	13	12.8	SR2	141
100-160mm	26	9	35	13	12.8	SR2	141
160-250mm	56.5	13	74.5	15	14.5	SR2	241
250-450mm	86.5	15	101.5	15	14.5	SR2.5	241



With dial indicator

Code	Range	Indicator	Accuracy	Repeatability
2322-35A	18-35mm	dial indicator, range 10mm, graduation 0.01mm (code 2308-10FA)	±0.015mm	0.003mm
2322-60A	35-60mm		±0.018mm	0.003mm
2322-100A	50-100mm		±0.018mm	0.003mm
2322-160A	50-160mm		±0.018mm	0.003mm
2322-161A	100-160mm		±0.018mm	0.003mm
2322-250A	160-250mm		±0.018mm	0.003mm
2322-450A	250-450mm		±0.018mm	0.003mm

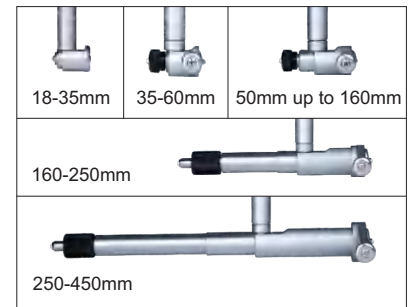

With digital indicator (optional data output cable:

code 7315-51B receiver is needed page 7, 7214-51B page 12, 7302-40M page 21)

Code	Range	Indicator	Accuracy	Repeatability
2122-35A	18-35mm	digital indicator, code 2108-10F , range 12.7mm/0.5", resolution 0.002mm/0.0001" (can switch to 0.01mm/0.0005")	±0.015mm	0.003mm
2122-60A	35-60mm		±0.018mm	0.003mm
2122-100A	50-100mm		±0.018mm	0.003mm
2122-160A	50-160mm		±0.018mm	0.003mm
2122-161A	100-160mm		±0.018mm	0.003mm
2122-250A	160-250mm		±0.018mm	0.003mm
2122-450A	250-450mm		±0.018mm	0.003mm

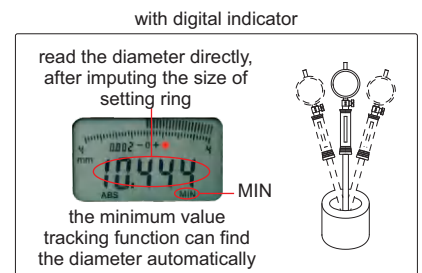

With waterproof digital indicator (optional data output cable:

code 7315-51B receiver is needed page 7, 7214-51B page 12, 7302-40M page 21)

Code	Range	Indicator	Accuracy	Repeatability
2122-35AWP	18-35mm	waterproof digital indicator, code 2137-10F , range 12.7mm/0.5", dust/waterproof IP54, resolution 0.002mm/0.0001" (can switch to 0.01mm/0.0005")	±0.015mm	0.003mm
2122-60AWP	35-60mm		±0.018mm	0.003mm
2122-100AWP	50-100mm		±0.018mm	0.003mm
2122-160AWP	50-160mm		±0.018mm	0.003mm
2122-161AWP	100-160mm		±0.018mm	0.003mm
2122-250AWP	160-250mm		±0.018mm	0.003mm
2122-450AWP	250-450mm		±0.018mm	0.003mm

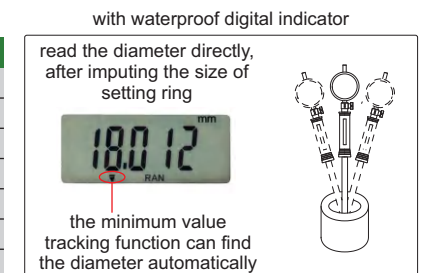

BORE GAUGES (WITH CENTERING PLATE)

ATTENTION: NOT SUITABLE
FOR 0.001MM DIAL INDICATORS

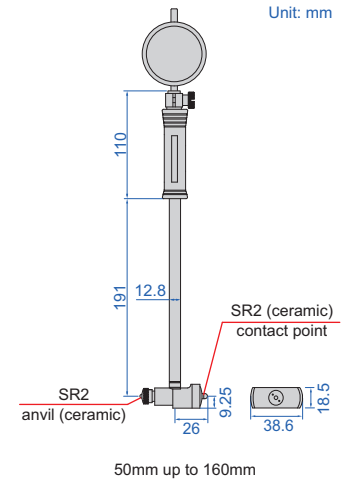
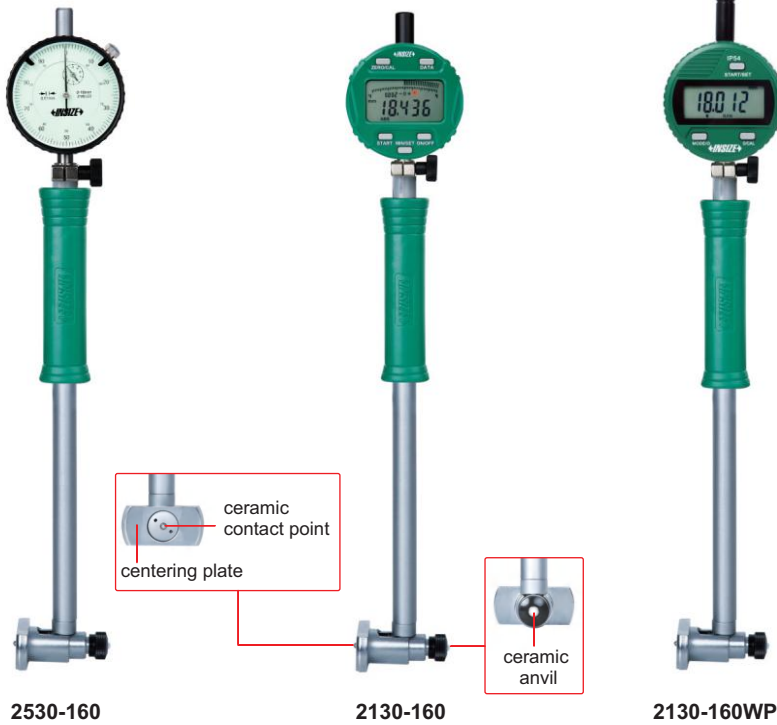

7

- Optional accessory: setting ring (code 6312), long handle (code 7351), bore gauge setter

with digital indicator

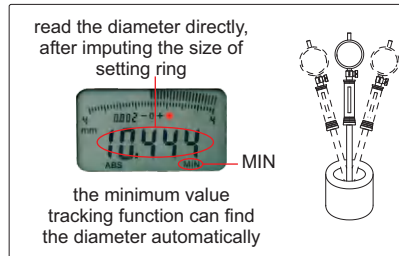

with waterproof digital indicator

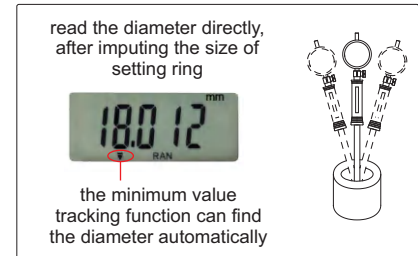

With dial indicator

Code	Range	Indicator	Accuracy	Repeatability
2530-100	50-100mm	dial indicator, range 10mm, graduation 0.01mm (code 2308-10FA)	±0.018mm	0.003mm
2530-160	50-160mm		±0.018mm	0.003mm
2530-161	100-160mm		±0.018mm	0.003mm

With digital indicator (optional data output cable: code 7315-51B receiver is needed page 7, 7214-51B page 12, 7302-40M page 21)

Code	Range	Indicator	Accuracy	Repeatability
2130-100	50-100mm	digital indicator, code 2108-10F, range 12.7mm/0.5", resolution 0.002mm/0.0001" (can switch to 0.01mm/0.0005")	±0.018mm	0.003mm
2130-160	50-160mm		±0.018mm	0.003mm
2130-161	100-160mm		±0.018mm	0.003mm

With waterproof digital indicator (optional data output cable: code 7315-51B receiver is needed page 7, 7214-51B page 12, 7302-40M page 21)

Code	Range	Indicator	Accuracy	Repeatability
2130-100WP	50-100mm	waterproof digital indicator, code 2137-10F, range 12.7mm/0.5", dust/waterproof IP54, resolution 0.002mm/0.0001" (can switch to 0.01mm/0.0005")	±0.018mm	0.003mm
2130-160WP	50-160mm		±0.018mm	0.003mm
2130-161WP	100-160mm		±0.018mm	0.003mm

ATTENTION: NOT SUITABLE FOR 0.001MM DIAL INDICATORS

BORE GAUGES (WITH DIAL INDICATOR)

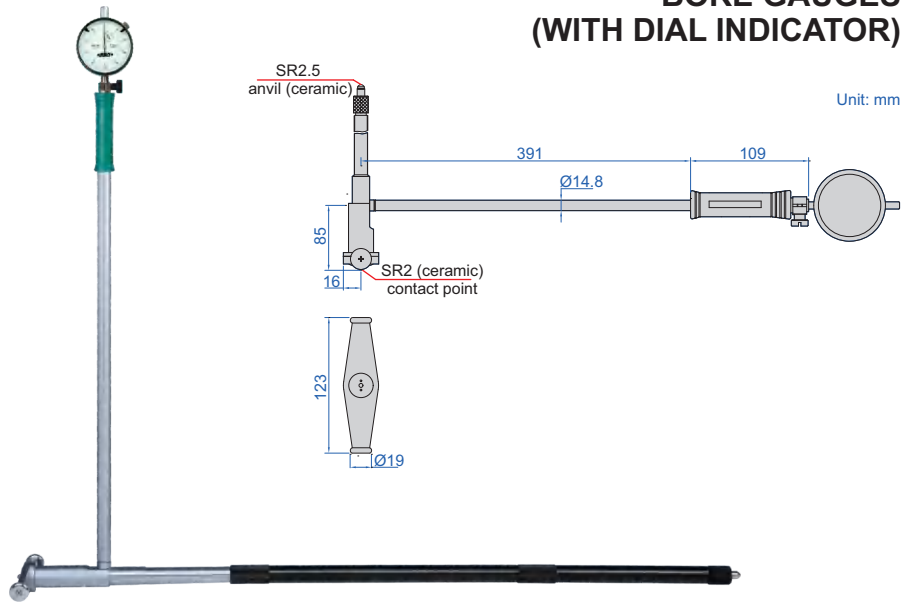

2828-800A

With dial indicator

Code	Range	Indicator	Accuracy	Repeatability
2828-800A	400-800mm	dial indicator, code 2308-10FA, range 10mm, graduation 0.01mm	±0.025mm	0.003mm

With digital indicator (optional data output cable: code 7315-51B receiver is needed page 7, 7214-51B page 12, 7302-40M page 21)

Code	Range	Indicator	Accuracy	Repeatability
2128-800A	400-800mm	digital indicator, code 2108-10F, range 12.7mm/0.5", resolution 0.002mm/0.0001" (can switch to 0.01mm/0.0005")	±0.025mm	0.003mm

With waterproof digital indicator (optional data output cable: code 7315-51B receiver is needed page 7, 7214-51B page 12, 7302-40M page 21)

Code	Range	Indicator	Accuracy	Repeatability
2128-800AWP	400-800mm	waterproof digital indicator, code 2137-10F, range 12.7mm/0.5", dust/waterproof IP54, resolution 0.002mm/0.0001" (can switch to 0.01mm/0.0005")	±0.025mm	0.003mm

ATTENTION: NOT SUITABLE FOR 0.001MM DIAL INDICATORS

BORE GAUGE SETS (WITH DIAL INDICATOR)



2824-S160



2724-S3



2724-S3WP

To be continued

Continued from previous page



- Optional accessory: setting ring (code **6312**), long handle (code **7351**), bore gauge setter

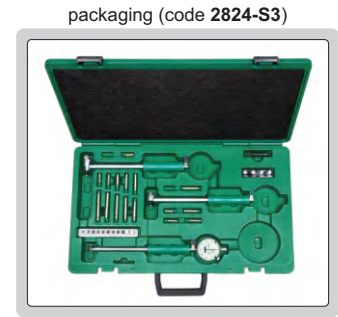
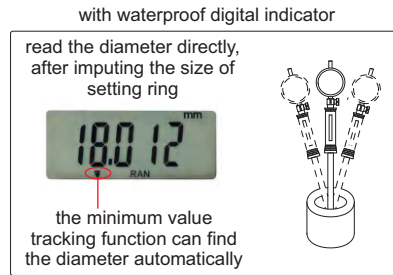
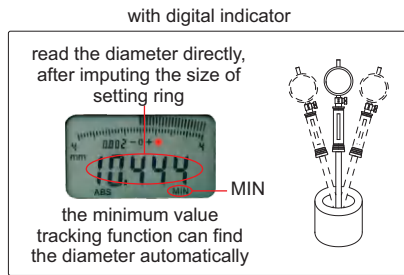

7

With dial indicator

Code	Range	Indicator	Bore gauges included	Accuracy	Repeatability
2824-S160	35-160mm	dial indicator, code 2308-10FA , range 10mm, graduation 0.01mm	① 35-50mm (dial indicator and handle are not included) ② 50-160mm	35-50mm ±0.018mm 50-160mm ±0.018mm	0.003mm
2824-S3	18-160mm	dial indicator, code 2308-10FA , range 10mm, graduation 0.01mm	① 18-35mm ② 35-60mm (dial indicator is not included) ③ 50-160mm (dial indicator is not included)	18-35mm ±0.015mm 35-60mm ±0.018mm 50-160mm ±0.018mm	0.003mm

With digital indicator (optional data output cable: code 7315-51B receiver is needed page 7, 7214-51B page 12, 7302-40M page 21)

Code	Range	Indicator	Bore gauges included	Accuracy	Repeatability
2724-S160	35-160mm	digital indicator, code 2108-10F range 12.7mm/0.5", resolution 0.002mm/0.0001" (can switch to: 0.01mm/0.0005")	① 35-50mm (digital indicator and handle are not included) ② 50-160mm	35-50mm ±0.018mm 50-160mm ±0.018mm	0.003mm
2724-S3	18-160mm	digital indicator, code 2108-10F range 12.7mm/0.5", resolution 0.002mm/0.0001" (can switch to: 0.01mm/0.0005")	① 18-35mm ② 35-60mm (digital indicator is not included) ③ 50-160mm (digital indicator is not included)	18-35mm ±0.015mm 35-60mm ±0.018mm 50-160mm ±0.018mm	0.003mm

With waterproof digital indicator (optional data output cable: code 7315-51B receiver is needed page 7, 7214-51B page 12, 7302-40M page 21)

Code	Range	Indicator	Bore gauges included	Accuracy	Repeatability
2724-S160WP	35-160mm	waterproof digital indicator, code 2137-10F , range 12.7mm/0.5", dust/waterproof IP54, resolution 0.002mm/0.0001" (can switch to 0.01mm/0.0005")	① 35-50mm (digital indicator and handle are not included) ② 50-160mm	35-50mm ±0.018mm 50-160mm ±0.018mm	0.003mm
2724-S3WP	18-160mm	waterproof digital indicator, code 2137-10F , range 12.7mm/0.5", dust/waterproof IP54, resolution 0.002mm/0.0001" (can switch to 0.01mm/0.0005")	① 18-35mm ② 35-60mm (digital indicator is not included) ③ 50-160mm (digital indicator is not included)	18-35mm ±0.015mm 35-60mm ±0.018mm 50-160mm ±0.018mm	0.003mm



ATTENTION: NOT SUITABLE FOR 0.001MM DIAL INDICATORS

BORE GAUGES (WITH DIAL INDICATOR)

- Optional accessory: setting ring (code **6312**), long handle (code **7351**), bore gauge setter

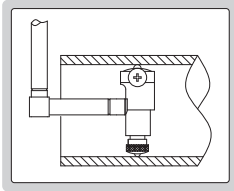

2827-160A

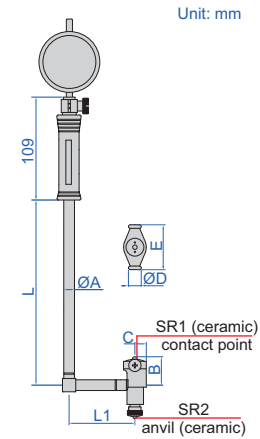

2308-10FA

2108-10F

2137-10F

with digital indicator

read the diameter directly, after inputting the size of setting ring



the minimum value tracking function can find the diameter automatically

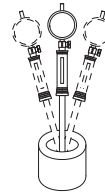

with waterproof digital indicator

read the diameter directly, after inputting the size of setting ring



the minimum value tracking function can find the diameter automatically

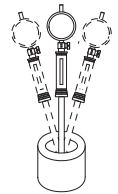

(mm)

Range	ØA	B	C	ØD	E	L	L1
35-60mm	12.8	22	9	13	27	141	75
50-160mm	12.8	28.5	9.2	13	35	141	76.2
160-250mm	14.5	62.0	12.7	15	74.5	391	100
250-450mm	14.5	91.5	15.0	15	101.5	391	100

With dial indicator

Code	Range	Indicator	Accuracy	Repeatability
2827-60A	35-60mm	dial indicator, code 2308-10FA , range 10mm, graduation 0.01mm	±0.018mm	0.003mm
2827-160A	50-160mm		±0.018mm	0.003mm
2827-250A	160-250mm		±0.018mm	0.003mm
2827-450A	250-450mm		±0.018mm	0.003mm

With digital indicator (optional data output cable: code 7315-51B receiver is needed page 7, 7214-51B page 12, 7302-40M page 21)

Code	Range	Indicator	Accuracy	Repeatability
2127-60	35-60mm	digital indicator, code 2108-10F , range 12.7mm/0.5", resolution 0.002mm/0.0001" (can switch to: 0.01mm/0.0005")	±0.018mm	0.003mm
2127-160	50-160mm		±0.018mm	0.003mm
2127-250	160-250mm		±0.018mm	0.003mm
2127-450	250-450mm		±0.018mm	0.003mm

With waterproof digital indicator (optional data output cable: code 7315-51B receiver is needed page 7, 7214-51B page 12, 7302-40M page 21)

Code	Range	Indicator	Accuracy	Repeatability
2127-60WP	35-60mm	waterproof digital indicator, code 2137-10F , range 12.7mm/0.5", dust/waterproof IP54, resolution 0.002mm/0.0001" (can switch to 0.01mm/0.0005")	±0.018mm	0.003mm
2127-160WP	50-160mm		±0.018mm	0.003mm
2127-250WP	160-250mm		±0.018mm	0.003mm
2127-450WP	250-450mm		±0.018mm	0.003mm

CARBON FIBER BORE GAUGES



SPRING LOADED MEASURING POINT

CARBON FIBER EXTENSION RODS, LIGHT WEIGHT, NOT EASY TO DEFORM, LOW THERMAL EXPANSION

DATA OUTPUT

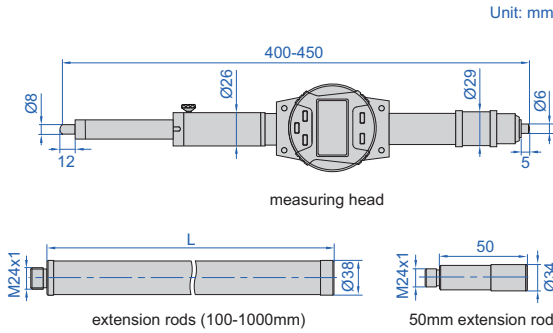

3522-1500

- Carbon fiber extension rods, light weight, not easy to deform, low thermal expansion
- Carbide measuring faces
- Data output
- Button function: on/off, zero, tolerance Go and No-Go display, data preset, measuring direction change, max./min./TIR measurement, inch/metric conversion, absolute/incremental measurement
- Supplied with 400mm setting standard
- Optional accessory: wireless transmitter code **7315-51** (receiver is needed) page 6, bluetooth transmitter code **7214-51** page 12, data output cable code **7302-40M** page 21

setting standard (included), used to set the measuring head

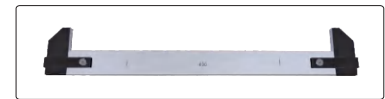

Measuring head

Range	Resolution	Accuracy	Repeatability	Weight
400-450mm	0.001mm/0.00005"	±6µm	±3µm	1kg

Extension rods

Length (L)	Accuracy	Weight	Material
50mm	±2µm	230g	steel
100mm	±3µm	300g	carbon fiber
200mm	±4.5µm	390g	carbon fiber
300mm	±6µm	470g	carbon fiber
600mm	±9µm	730g	carbon fiber
1000mm	±11µm	1000g	carbon fiber

spring loaded point, and max./min. value tracking make it easy to find the right measuring position



Code	Range	Weight	Extension rods
3522-1000	400-1000mm	3.8kg	50mm, 100mm, 200mm, 300mm
3522-1500	400-1500mm	4.5kg	50mm, 100mm, 200mm, 300mm, 600mm
3522-2000	400-2000mm	5.3kg	50mm, 100mm, 200mm, 300mm, 600mm (2 pcs)
3522-2400	400-2400mm	6.0kg	50mm, 100mm, 200mm, 300mm, 600mm (3 pcs)
3522-3400	400-3400mm	6.7kg	50mm, 100mm, 200mm, 300mm, 600mm (4 pcs)
3522-6400	400-6400mm	9.5kg	50mm, 100mm, 200mm, 300mm, 600mm, 1000mm (5 pcs)

ATTENTION: NOT SUITABLE FOR 0.001MM DIAL INDICATORS

MEASURE DIAMETER OF BORES WITH BARRIER INSIDE

BORE GAUGE FOR BARRIER INSIDE BORE



digital indicator is optional

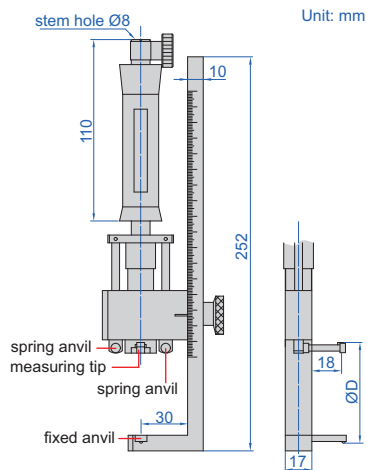

2348-210

- Measure diameter of bores with barrier inside
- Optional accessory:
 - 0.01mm graduation dial indicators
 - Setting ring (code 6312)

Code	Range $\varnothing D$	Diameter of barrier $\varnothing d$	Travel of measuring tip	Accuracy (without dial indicator)	Measuring force
2348-210	40-210mm	<D-14 (less than 50mm)*	1.6	0.018	2N

*For example:

When measuring size $\varnothing D$ is 40mm, D-14=26mm, so the diameter of barrier should be less than 26mm.
 When measuring size $\varnothing D$ is 70mm, D-14=56mm, however it should be less than 50mm, so the diameter of barrier should be less than 50mm.

LONG HANDLES

method of use (replace the original handle with long handle)

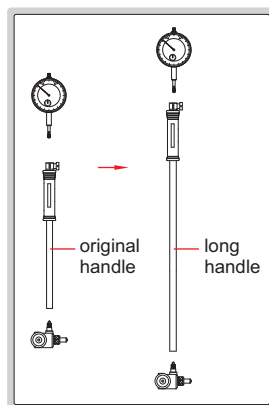

- To assist deep-hole measurement
- Can be used for bore gauges 2322, 2122, 2130, 2530, 2828, 2128, 2824, 2724, 2827 and 2127

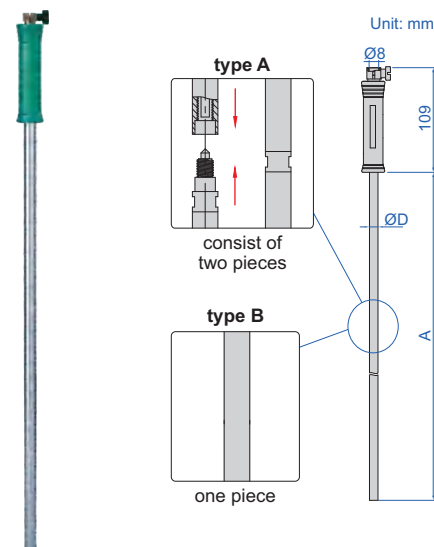

7351-EX11

Code	Applicable bore gauges	A	$\varnothing D$	Type
7351-EX10	18-35mm	475mm	9mm	B
7351-EX11	35-60mm,	475mm	13mm	
7351-EX12	50-100mm,	980mm	13mm	A
7351-EX13	50-160mm,	1480mm	14.5mm	
7351-EX14	100-160mm	1980mm	14.5mm	B
7351-EX21	160-250mm, 250-450mm	480mm	14.5mm	
7351-EX22		980mm	14.5mm	
7351-EX23		1480mm	14.5mm	
7351-EX24		1980mm	14.5mm	

ANVILS FOR BORE GAUGES



- For bore gauges 2284, 2853, 2153, 2852, 2152, 2283, 2825, 2126, 2322, 2122, 2530, 2130, 2824, 2724, 2827 and 2127

Code	Applicable bore gauges	Material of measuring face	Quantity per set	Measuring range of anvil (mm)
7350-10	6-10mm	steel	9 pcs	6, 6.5, 7, 7.5, 8, 8.5, 9, 9.5, 10
7350-18	10-18.5mm	ceramic	9 pcs	10, 11, 12, 13, 14, 15, 16, 17, 18
7350-35	18-35mm	ceramic	9 pcs	18, 20, 22, 24, 26, 28, 30, 32, 34
7350-60	35-60mm	ceramic	6 pcs	35, 40, 45, 50, 55, 60
7350-100	50-100mm	ceramic	11 pcs	50, 55, 60, 65, 70, 75, 80, 85, 90, 95, 100
7350-160	50-160mm	ceramic	12 pcs	50, 55, 60, 65, 70, 75, 80, 85, 90, 95, 100, 105
7350-161	100-160mm	ceramic	12 pcs	50, 55, 60, 65, 70, 75, 80, 85, 90, 95, 100, 105
7350-250	160-250mm	ceramic	5 pcs	160, 170, 180, 190, 200
7350-450	250-450mm	ceramic	5 pcs	250, 260, 270, 280, 290

7

BORE GAUGE SETTERS

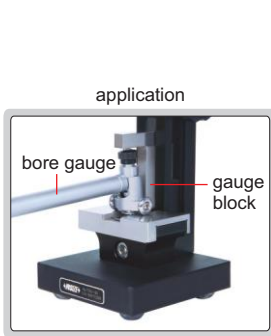

7353-160

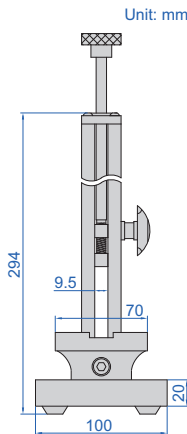

- Vertical and horizontal use
- To be used with gauge blocks

Gauge block set for 7353-160

Blocks per set	Size (mm)	Step (mm)	Quantity	Remark
33	1.005		1 pc	grade 2 (ISO3650)
	1.01-1.09	0.01	9 pcs	
	1.1-1.9	0.1	9 pcs	
	1-9	1	9 pcs	
	10-30	10	3 pcs	
	50		1 pc	
	100		1 pc	

Code	Range	Repeatability	Remark
7353-160	0-160mm	1.2µm	with gauge block set
7353-160W	0-160mm	1.2µm	without gauge block set

BORE GAUGE SETTER



- Used together with gauge blocks to set bore gauges

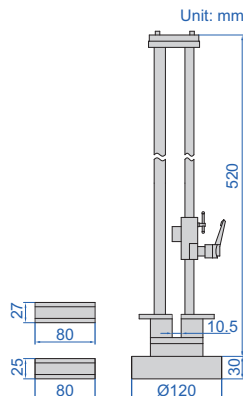

2395-400

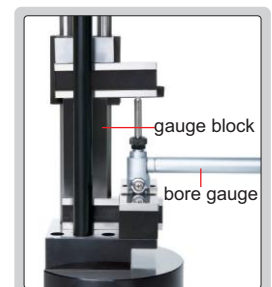

Code	Setting range
2395-400	18-400mm



DIGITAL INTERNAL CHAMFER GAUGES

INSIZE PLUS
MADE IN EUROPE



2962-609

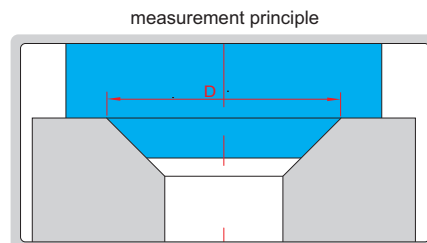

measure end diameter of chamfer holes

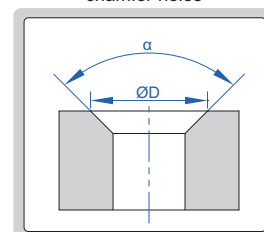

- Measure end diameter of chamfer holes
- Resolution: 0.01mm/0.0005"
- Direct read (end diameter), no calculations
- TiN coated, hardness 2200HV, wear/rust-resistant
- Optional accessory:
wireless transmitter code **7315-50M** (receiver is needed) page 6,
bluetooth transmitter code **7214-50M** page 12,
data output cable code **7302-40M** page 21

Chamfer hole angle $\alpha=90^\circ$

Code	Range $\varnothing D$	α	Accuracy
2962-209 *	1-20mm	90°	±0.02mm
2962-409 *	20-40mm	90°	±0.02mm
2962-609 *	40-60mm	90°	±0.02mm
2962-809 *	60-80mm	90°	±0.02mm
2962-1009 *	80-100mm	90°	±0.02mm
2962-1209 *	100-120mm	90°	±0.02mm

Chamfer hole angle $\alpha=127^\circ$

Code	Range $\varnothing D$	α	Accuracy
2962-207 *	1-20mm	127°	±0.02mm
2962-407 *	20-40mm	127°	±0.02mm
2962-607 *	40-60mm	127°	±0.02mm
2962-807 *	60-80mm	127°	±0.02mm
2962-1007 *	80-100mm	127°	±0.02mm
2962-1207 *	100-120mm	127°	±0.02mm

Chamfer hole angle $\alpha=60^\circ$

Code	Range $\varnothing D$	α	Accuracy
2962-126 *	1-10mm	60°	±0.02mm
2962-216 *	10-20mm	60°	±0.02mm
2962-316 *	20-30mm	60°	±0.02mm
2962-416 *	30-40mm	60°	±0.02mm
2962-516 *	40-50mm	60°	±0.02mm
2962-616 *	50-60mm	60°	±0.02mm
2962-716 *	60-70mm	60°	±0.02mm
2962-816 *	70-80mm	60°	±0.02mm
2962-916 *	80-90mm	60°	±0.02mm
2962-1016 *	90-100mm	60°	±0.02mm
2962-1116 *	100-110mm	60°	±0.02mm
2962-1216 *	110-120mm	60°	±0.02mm

* Supplied with manufacturer inspection certificate

- 4 gauges per set
- For small holes, slots and grooves, etc.
- Satin chrome finish



4208-1

Range	L	a	b	$\varnothing D$
3-5mm	76	24	52	5
5-7.5mm	79	27	52	5
7.5-10mm	88	30	58	6
10-13mm	91	34	58	6

Code	Total range	Gauges included
4208-1	3-13mm	3-5mm, 5-7.5mm, 7.5-10mm, 10-13mm

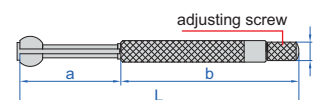
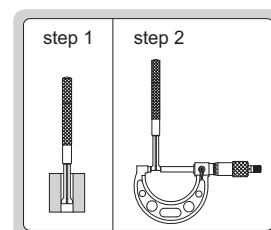

SMALL HOLE GAUGE SET

TELESCOPING GAUGE SET

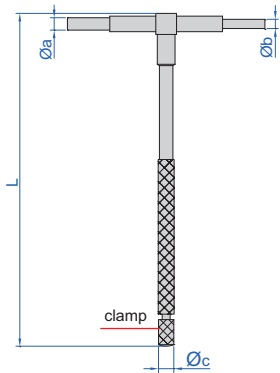

4206-1

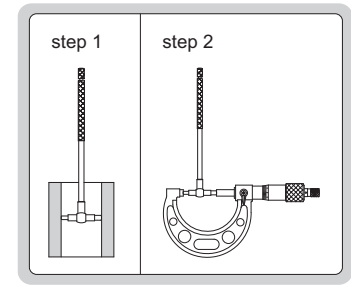

- 6 gauges per set
- For quick measurement of inside diameter of holes and width of slots
- Satin chrome finish

(mm)				
Range	L	Øa	Øb	Øc
8-12.7mm	115	3.9	2.9	4.7
12.7-19mm	115	5.3	3.8	4.7
19-32mm	115	5.3	3.8	4.7
32-54mm	137	7.6	6.1	6.2
54-90mm	137	7.6	6.1	6.2
90-150mm	137	7.6	6.1	6.2

Code	Total range	Gauges included
4206-1	8-150mm	8-12.7mm, 12.7-19mm, 19-32mm, 32-54mm, 54-90mm, 90-150mm

7

LONG HANDLE TELESCOPING GAUGES

- For quick measurement of inside diameter of deep holes and width of slots
- Satin chrome finish

(mm)					
Code	Range	L	Øa	Øb	Øc
4209-1	8-12.7mm	300	3.9	2.9	6.2
4209-2	12.7-19mm	300	5.3	3.8	6.2
4209-3	19-32mm	300	5.3	3.8	6.2
4209-4	32-54mm	300	7.6	6.1	7.2
4209-5	54-90mm	300	7.6	6.1	7.2
4209-6	90-150mm	300	7.6	6.1	7.2

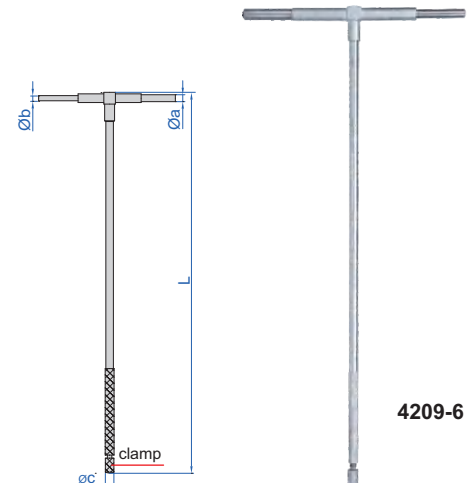
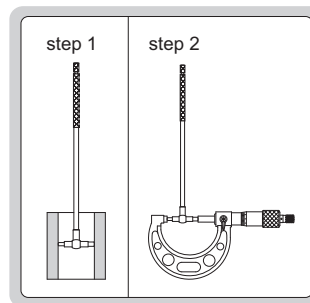

4209-6

FLEXIBLE INNER DIAMETER METERS

- Measure average inner diameter of flexible materials
- Made of PET



7137-60

application



Code	Diameter range	Graduation	Accuracy
7137-30	Ø10-30mm	0.05mm	±0.10mm
7137-60	Ø30-60mm	0.05mm	±0.10mm
7137-100	Ø50-100mm	0.05mm	±0.10mm
7137-200	Ø100-200mm	0.05mm	±0.10mm
7137-350	Ø200-350mm	0.05mm	±0.15mm



CAN BE CUSTOM-MADE

DIAMETER METERS



7135-525

Unit: mm



- Measure diameter of pipes, trees, tires, etc.
- Made of stainless steel

Standard type

Code	Diameter range	Graduation	Accuracy
7135-35 *	Ø20-35mm	0.05mm	±0.05mm
7135-55 *	Ø30-55mm	0.05mm	±0.05mm
7135-125	Ø50-125mm	0.01mm	±0.05mm
7135-225	Ø100-225mm	0.01mm	±0.05mm
7135-375	Ø200-375mm	0.01mm	±0.05mm
7135-525	Ø350-525mm	0.01mm	±0.05mm
7135-725	Ø500-725mm	0.01mm	±0.06mm
7135-925	Ø700-925mm	0.01mm	±0.06mm
7135-1125	Ø900-1125mm	0.02mm	±0.06mm
7135-1325	Ø1100-1325mm	0.02mm	±0.08mm
7135-1525	Ø1300-1525mm	0.02mm	±0.08mm
7135-1725	Ø1500-1725mm	0.02mm	±0.08mm
7135-1925	Ø1700-1925mm	0.02mm	±0.08mm
7135-2125	Ø1900-2125mm	0.02mm	±0.08mm
7135-2325	Ø2100-2325mm	0.02mm	±0.10mm
7135-2525	Ø2300-2525mm	0.02mm	±0.10mm
7135-2750	Ø2500-2750mm	0.02mm	±0.10mm
7135-3000	Ø2750-3000mm	0.02mm	±0.10mm
7135-3250	Ø3000-3250mm	0.02mm	±0.15mm
7135-3500	Ø3250-3500mm	0.02mm	±0.15mm

Code	Diameter range	Graduation	Accuracy
7135-3750	Ø3500-3750mm	0.02mm	±0.15mm
7135-4000	Ø3750-4000mm	0.02mm	±0.20mm
7135-4250	Ø4000-4250mm	0.02mm	±0.20mm
7135-4500	Ø4250-4500mm	0.02mm	±0.20mm
7135-4750	Ø4500-4750mm	0.02mm	±0.20mm
7135-5000	Ø4750-5000mm	0.02mm	±0.20mm
7135-5250	Ø5000-5250mm	0.02mm	±0.005%L **
7135-5500	Ø5250-5500mm	0.02mm	±0.005%L **
7135-5750	Ø5500-5750mm	0.02mm	±0.005%L **
7135-6000	Ø5750-6000mm	0.02mm	±0.005%L **
7135-6250	Ø6000-6250mm	0.02mm	±0.005%L **
7135-6500	Ø6250-6500mm	0.02mm	±0.005%L **
7135-6750	Ø6500-6750mm	0.02mm	±0.005%L **
7135-7000	Ø6750-7000mm	0.02mm	±0.005%L **
7135-7250	Ø7000-7250mm	0.02mm	±0.005%L **
7135-7500	Ø7250-7500mm	0.02mm	±0.005%L **
7135-7750	Ø7500-7750mm	0.02mm	±0.005%L **
7135-8000	Ø7750-8000mm	0.02mm	±0.005%L **
7135-8250	Ø8000-8250mm	0.02mm	±0.005%L **

Long type

Code	Diameter range	Graduation	Accuracy
7135-80 *	Ø9-80mm	0.05mm	±0.05mm
7135-55B *	Ø15-55mm	0.02mm	±0.05mm
7135-300	Ø50-300mm	0.01mm	±0.05mm
7135-600	Ø300-600mm	0.01mm	±0.05mm
7135-900	Ø600-900mm	0.01mm	±0.06mm
7135-1200	Ø900-1200mm	0.02mm	±0.08mm
7135-1500	Ø1200-1500mm	0.02mm	±0.08mm
7135-1800	Ø1500-1800mm	0.02mm	±0.08mm
7135-2100	Ø1800-2100mm	0.02mm	±0.08mm
7135-2400	Ø2100-2400mm	0.02mm	±0.10mm
7135-2700	Ø2400-2700mm	0.02mm	±0.10mm
7135-3000B	Ø2700-3000mm	0.02mm	±0.10mm
7135-3300	Ø3000-3300mm	0.02mm	±0.15mm
7135-3600	Ø3300-3600mm	0.02mm	±0.15mm
7135-3900	Ø3600-3900mm	0.02mm	±0.20mm
7135-4200	Ø3900-4200mm	0.02mm	±0.20mm
7135-4500B	Ø4200-4500mm	0.02mm	±0.20mm

Code	Diameter range	Graduation	Accuracy
7135-4800	Ø4500-4800mm	0.02mm	±0.20mm
7135-5100	Ø4800-5100mm	0.02mm	±0.005%L **
7135-5400	Ø5100-5400mm	0.02mm	±0.005%L **
7135-5700	Ø5400-5700mm	0.02mm	±0.005%L **
7135-6000B	Ø5700-6000mm	0.02mm	±0.005%L **
7135-6300	Ø6000-6300mm	0.02mm	±0.005%L **
7135-6600	Ø6300-6600mm	0.02mm	±0.005%L **
7135-6900	Ø6600-6900mm	0.02mm	±0.005%L **
7135-7200	Ø6900-7200mm	0.02mm	±0.005%L **
7135-7500B	Ø7200-7500mm	0.02mm	±0.005%L **
7135-7800	Ø7500-7800mm	0.02mm	±0.005%L **
7135-8100	Ø7800-8100mm	0.02mm	±0.005%L **
7135-8400	Ø8100-8400mm	0.02mm	±0.005%L **
7135-8700	Ø8400-8700mm	0.02mm	±0.005%L **
7135-9000	Ø8700-9000mm	0.02mm	±0.005%L **
7135-9300	Ø9000-9300mm	0.02mm	±0.005%L **

* The thickness of code 7135-35, 7135-55, 7135-80 and 7135-55B is 0.10mm, while the thickness of other codes is 0.25mm

** L is the actual measured value (unit: mm)

CIRCUMFERENCE METERS

CAN BE CUSTOM-MADE

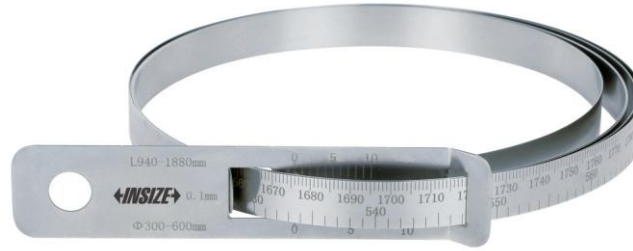
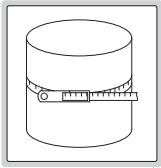

7136-1880

- Measure diameter and circumference of pipes, trees, tires, etc.
- Made of stainless steel

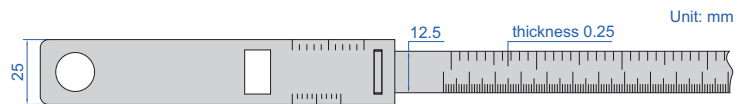

Code	Circumference range	Diameter range	Graduation	Accuracy	
				circumference	diameter
7136-940	160-940mm	Ø50-300mm	0.1mm	±0.30mm	±0.10mm
7136-1880	940-1880mm	Ø300-600mm	0.1mm	±0.30mm	±0.10mm
7136-2830	1880-2830mm	Ø600-900mm	0.1mm	±0.30mm	±0.10mm
7136-3770	2830-3770mm	Ø900-1200mm	0.1mm	±0.30mm	±0.10mm
7136-4710	3770-4710mm	Ø1200-1500mm	0.1mm	±0.30mm	±0.10mm
7136-5650	4710-5650mm	Ø1500-1800mm	0.1mm	±0.30mm	±0.10mm
7136-6600	5650-6600mm	Ø1800-2100mm	0.1mm	±0.30mm	±0.10mm
7136-7540	6600-7540mm	Ø2100-2400mm	0.1mm	±0.30mm	±0.10mm
7136-8480	7540-8480mm	Ø2400-2700mm	0.1mm	±0.30mm	±0.10mm
7136-9430	8480-9430mm	Ø2700-3000mm	0.1mm	±0.30mm	±0.10mm

CIRCUMFERENCE METERS (ECONOMIC TYPE)

- Measure diameter and circumference of soft materials like pipes, trees, tires, etc.
- Graduation: 0.1mm
- Laser engraved scale
- Made of stainless steel



7114-950

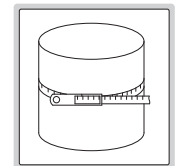

Code	Circumference range	Diameter range	Accuracy	
			circumference	diameter
7114-950	150-950mm	Ø50-300mm	±3mm	±1mm
7114-2200	940-2200mm	Ø300-700mm	±3mm	±1mm
7114-3460	2190-3460mm	Ø700-1100mm	±3mm	±1mm

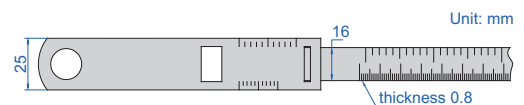

REFER TO PAGE 456-457
FOR DETAILS

TAPER GAUGES



4833-2



front back

TAPER GAUGE SET
4837-1

REFER TO PAGE 458
FOR DETAILS

TAPER BORE GAUGES



4852-15

REFER TO PAGE 458
FOR DETAILS

SMALL TAPER BORE GAUGE



4855-5

REFER TO PAGE 466
FOR DETAILS

INSIDE SPRING CALIPERS



7261-150



Outside Diameter Variation Measuring
Instruments
Page 234



Outside Diameter Measuring
Instruments
Page 235



Digital Radius Gauges
Page 236



Digital Radius Gauges
Page 237-238



Digital Arc Radius Calipers
Page 238



Digital Radius Calipers
Page 239



Radius Gauges
Page 239

CAN BE
CUSTOM-MADE



OUTSIDE DIAMETER VARIATION MEASURING INSTRUMENTS

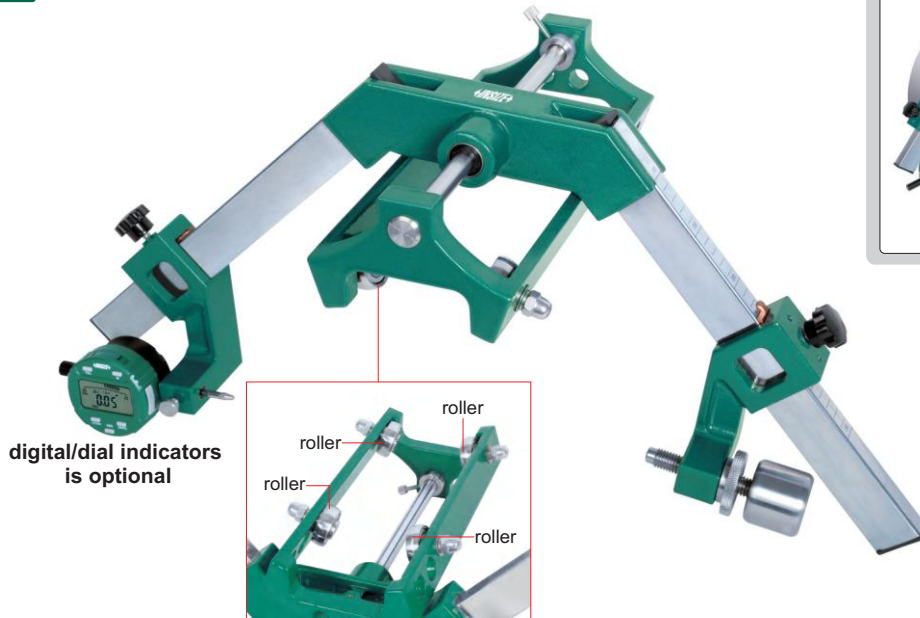

application

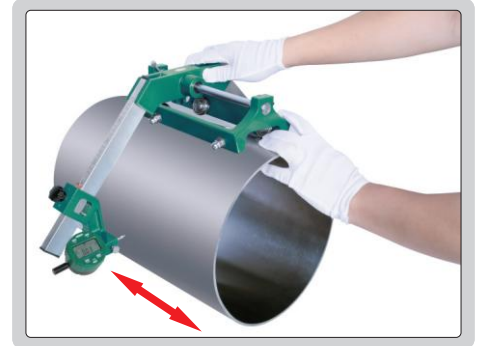

2715-350

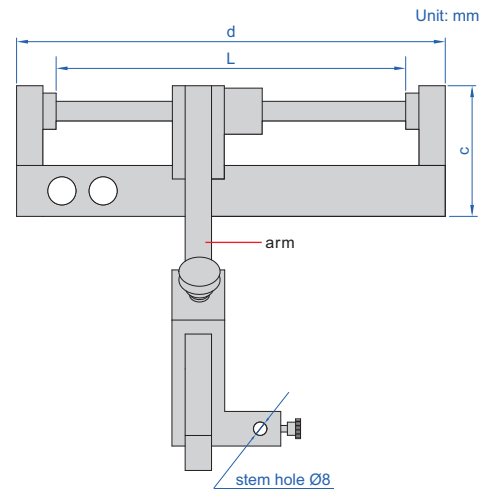
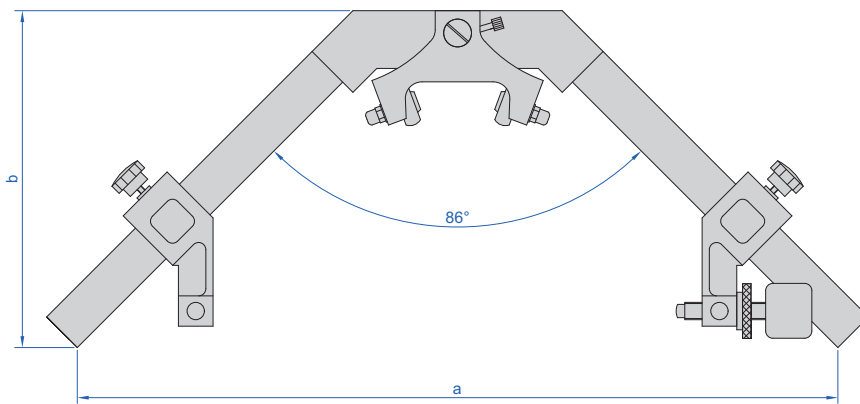

- Measurement of diameter variation, convexity, concavity, taper and other parameters
- Continuous measurement in the axis direction
- Four rollers are included
- Optional accessory: 0.01mm or 0.001mm graduation digital/dial indicators

(mm)

Code	Range (diameter)	Accuracy	Repeatability	Arm moving range (L)	a	b	c	d	Weight
2715-350	100-350mm/4-14"	0.01mm	3µm	200mm	500	230	80	260	4kg
2715-500	200-500mm/8-20"	0.01mm	3µm	151mm	630	260	95	260	5kg
2715-700	300-700mm/12-28"	0.01mm	3µm	197mm	910	372	112	320	6.5kg
2715-1000	500-1000mm/20-40"	0.01mm	3µm	190mm	1170	460	120	320	8kg
2715-1600	800-1600mm/32-64"	0.02mm	6µm	202mm	1860	690	180	320	12.5kg
2715-2000	1400-2000mm/56-80"	0.02mm	6µm	232mm	2156	860	210	350	18.5kg

OUTSIDE DIAMETER MEASURING INSTRUMENTS

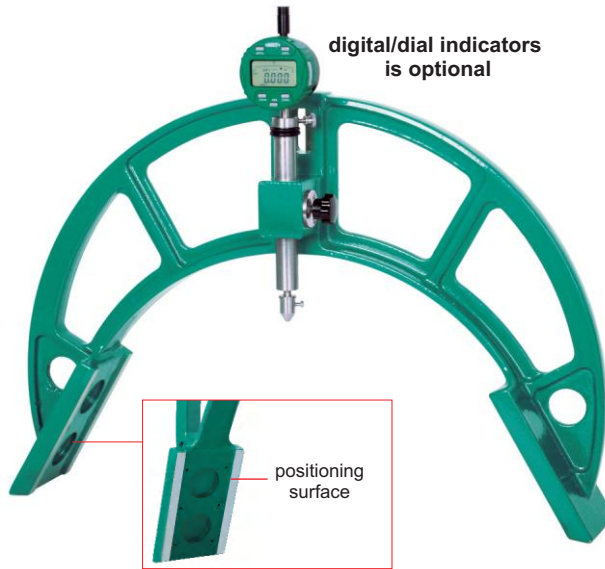

2716-500

- Need standard workpieces to set zero
- The frame is made of aluminum magnesium alloy with light weight and high strength
- Optional accessory: 0.01mm or 0.001mm digital/dial indicators

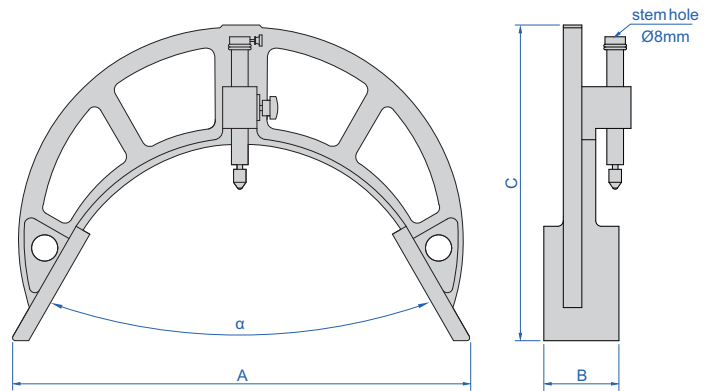

Code	Range (diameter)	Repeatability	α	A	B	C	Weight
2716-60	18-60	0.01mm	60°	140	60	160	1kg
2716-120	60-120	0.01mm	60°	166	65	162	1.5kg
2716-200	120-200	0.01mm	60°	225	70	228	2kg
2716-300	200-300	0.01mm	60°	330	80	262	2.5kg
2716-400	300-400	0.01mm	60°	405	80	303	4kg
2716-500	400-500	0.01mm	60°	494	80	340	5kg
2716-600	500-600	0.01mm	60°	594	80	398	6kg
2716-700	600-700	0.01mm	60°	685	80	446	7.5kg
2716-800	700-800	0.01mm	60°	772	80	479	9kg
2716-900	800-900	0.01mm	60°	860	80	520	10kg
2716-1000	900-1000	0.01mm	60°	950	80	560	11.5kg
2716-1100	1000-1100	0.01mm	60°	1035	90	575	13kg
2716-1200	1000-1200	0.01mm	83.62°	960	100	460	12kg
2716-1300	1100-1300	0.01mm	83.62°	1000	100	485	13.5kg
2716-1400	1200-1400	0.01mm	83.62°	1100	100	512	15kg
2716-1600	1400-1600	0.01mm	83.62°	1260	100	540	17kg
2716-1800	1600-1800	0.01mm	83.62°	1460	100	570	19kg
2716-2000	1800-2000	0.01mm	83.62°	1645	100	605	21kg

(mm)

DATA
OUTPUT



DIGITAL RADIUS GAUGES



2188-55



2188-233



2188-143



2188-323

- Measure radius of external arc, arc angle of measured surface should be larger than 60°
- Display radius value, no need to calculate
- Button function: on/off, zero, data preset, inch/mm
- Keep preset data in memory after restart
- CR2032 battery, automatic power off (time is adjustable)
- Data output
- Stainless steel base
- Optional accessory: setting standards, wireless transmitter code **7315-50M** (receiver is needed) page 6, bluetooth transmitter code **7214-50M** page 12, data output cable code **7302-40M** page 21

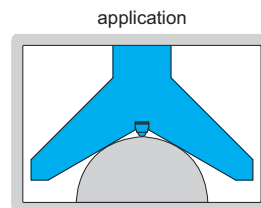

application

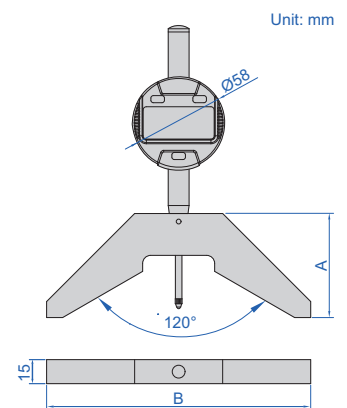

Unit: mm

Code	Range (radius)	Resolution	Accuracy	A	B
2188-55	4-53mm/0.16-2.09"	0.01mm/0.0005"	±0.02mm	40mm	65mm
2188-143	48-143mm/1.89-5.63"	0.01mm/0.0005"	±0.03mm	65mm	165mm
2188-233	138-233mm/5.43-9.17"	0.01mm/0.0005"	±0.03mm	85mm	255mm
2188-323	228-323mm/8.98-12.72"	0.01mm/0.0005"	±0.04mm	95mm	345mm

Setting standards

Code	Setting standards	Remark
4110-10D00	setting standard for 2188-55	included
2188-P143	setting standard for 2188-143	optional
2188-P233	setting standard for 2188-233	optional
2188-P323	setting standard for 2188-323	optional



2188-P143

setting standard application



DIGITAL RADIUS GAUGE (LOW ACCURACY)

DATA OUTPUT



2183

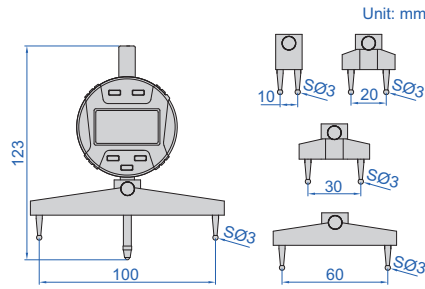

Unit: mm

calibration standard application



- Resolution: 0.01mm/0.001"
- Buttons: on/off, hold, mm/inch, s (select jaws), zero
- Measure radius of internal or external arcs
- Display can be rotated by 320°
- Supplied with 5 jaws for different sizes of arc
- Data output
- Battery CR2032
- Automatic power off (time is adjustable)
- Optional accessory: calibration standard (code **2183-BLOCK**), wireless transmitter code **7315-2183** (receiver is needed) page 7, data output cable code **7302-2183**

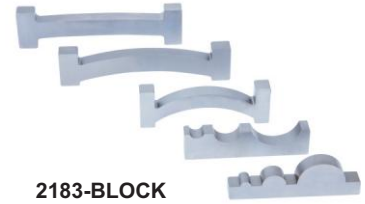
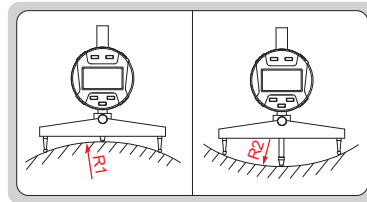

2183-BLOCK

Calibration standard (optional)

Code	Remark
2183-BLOCK	includes 5 standard blocks

Code	Range of external radius (R1)	Range of internal radius (R2)	Accuracy (mm)
2183	5-910mm/0.2-35.83"	7-910mm/0.3-35.83"	±0.01R*

*R is the radius to be measured. For example, radius is 100mm, the accuracy is ±0.01x100=±1mm

DIGITAL RADIUS GAUGE

DATA OUTPUT



2511

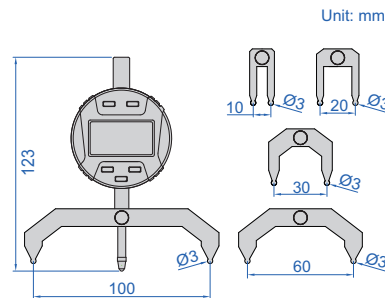

Unit: mm

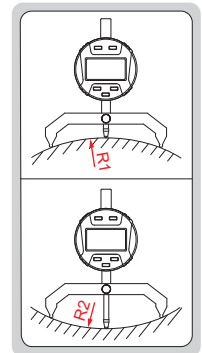

- Resolution: 0.01mm/0.001"
- Buttons: on/off, hold, mm/inch, s (select jaws), zero
- Measure radius of internal or external arcs
- Cylindrical measuring jaws, self-positioning
- Display can be rotated by 320°
- Supplied with 5 jaws for different sizes of arc
- Data output
- Battery CR2032
- Automatic power off (time is adjustable)
- Optional accessory: calibration standard (code **2183-BLOCK**), wireless transmitter code **7315-2183** (receiver is needed) page 7, data output cable code **7302-2183**

calibration standard application

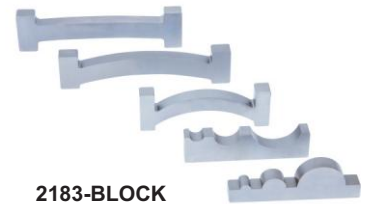

2183-BLOCK

Calibration standard (optional)

Code	Remark
2183-BLOCK	includes 5 standard blocks

Code	Range of external radius (R1)	Range of internal radius (R2)	Accuracy (mm)
2511	5-910mm/0.2-35.83"	7-910mm/0.3-35.83"	±0.005R*

*R is the radius to be measured. For example, radius is 100mm, the accuracy is ±0.005x100=±0.5mm

LARGE RANGE DIGITAL RADIUS GAUGE

DATA
OUTPUT

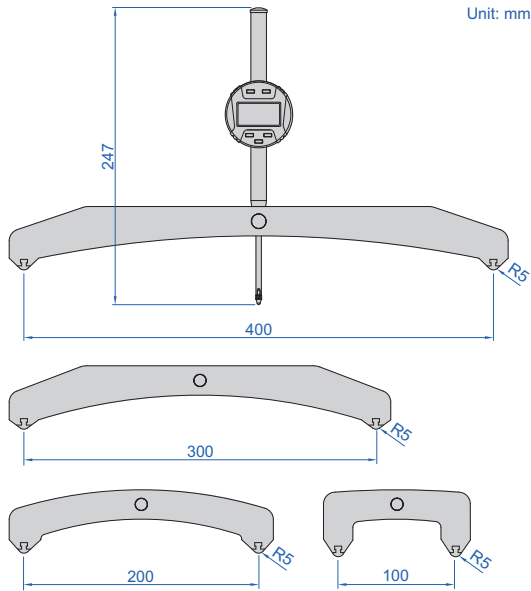

2197

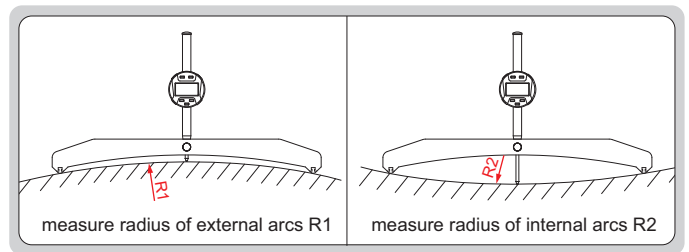

- Measure radius of internal or external arcs
- Resolution: 0.01mm/0.001"
- Buttons: on/off, hold, mm/inch, s (select jaws), zero
- Display can be rotated by 320°
- Supplied with 4 jaws for different sizes of arc
- Battery CR2032, automatic power off (time is adjustable)
- Data output
- Optional accessory: wireless transmitter code **7315-2183** (receiver is needed) page 7, data output cable code **7302-2183**

Code	Range of external radius (R1)	Range of internal radius (R2)	Accuracy (mm)
2197	100-15000mm/4-590"	100-15000mm/4-590"	±0.005R*

*R is the radius to be measured. For example, radius is 100mm, the accuracy is $\pm 0.005 \times 100 = \pm 0.5\text{mm}$

8



DATA
OUTPUT

DIGITAL ARC RADIUS CALIPERS

- Non waterproof
- Measure the radius of arc less than half round
- Resolution: 0.01mm/0.0005"
- Buttons: on/off, zero, mm/inch
- Automatic power off, move the digital unit to turn on power
- Battery CR2032
- Data output
- Made of stainless steel



1189-200B

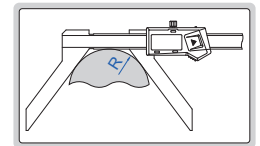

With data interface (optional data output cable: code 7315-25 receiver is needed page 5, 7214-25 page 11, 7302-21 page 20)

Code	Range (R)	Accuracy	L	c	d
1189-150B	5-150mm/0.2-6"	±0.05mm	263mm	16mm	65mm
1189-200B	5-200mm/0.2-8"	±0.07mm	313mm	16mm	85mm

Built-in wireless (receiver code 7315-2/3/6/7/8/9 is needed)

Code	Range (R)	Accuracy	L	c	d
1189-150BWL	5-150mm/0.2-6"	±0.05mm	263mm	16mm	65mm
1189-200BWL	5-200mm/0.2-8"	±0.07mm	313mm	16mm	85mm

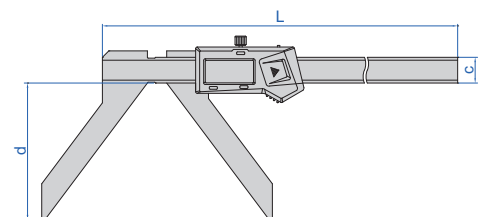

DIGITAL RADIUS CALIPERS

DATA
OUTPUT

DIRECT READING,
CALCULATION IS NOT REQUIRED



1501-25



1501-10

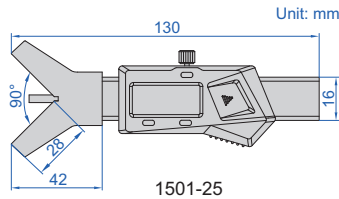

1501-25

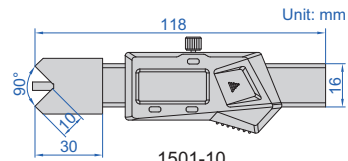

1501-10

8

- Non waterproof
- Measure radius of external arc, arc angle of measured surface should be larger than 90°
- Resolution: 0.01mm/0.0005"
- Buttons: on/off, zero, mm/inch
- Automatic power off, move the digital unit to turn on power
- Battery CR2032
- Data output
- Made of stainless steel
- Supplied with pin gauge for zero setting
- Optional accessory:
wireless transmitter code **7315-25** (receiver is needed) page 5,
bluetooth transmitter code **7214-25** page 11,
data output cable code **7302-21** page 20

1501-10 can measure small workpieces or workpieces with steps

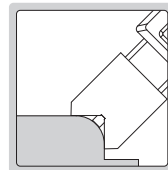

application

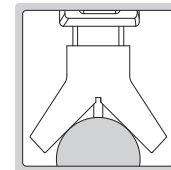

pin gauge (included)



Code	Range (radius)	Accuracy
1501-25	2-25mm/0.079-1"	±0.05mm
1501-10	2-10mm/0.079-0.394"	±0.05mm

RADIUS GAUGES

REFER TO PAGE 451-452
FOR DETAILS



4801-17



4802-31



RADIUS GAUGE SET
4804-26



Keyway Symmetry Gauges
Page 241



Keyway Symmetry Digital Calipers
Page 241



Digital Keyway Depth Gauges
Page 242



Groove Micrometers
Page 242



Digital Chamfer Gauges
Page 243



Chamfer Gauges
Page 244



Digital Chamfer Gauges
Page 244

KEYWAY SYMMETRY GAUGE



4865-14

- Used to measure the symmetry of shaft keyways

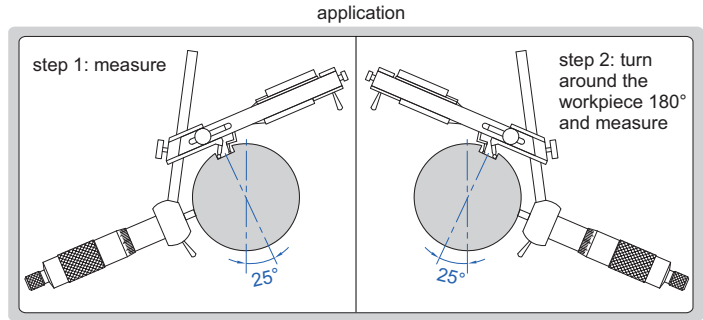

Unit: mm

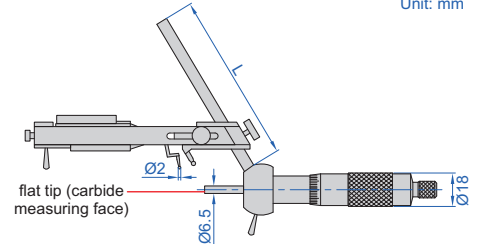

Code	Range		Graduation	Accuracy	L
	diameter of shaft	width of keyway			
4865-14	14-110mm	5-28mm	0.01mm	0.02mm	100mm

KEYWAY SYMMETRY DIGITAL CALIPERS

9



1531-60

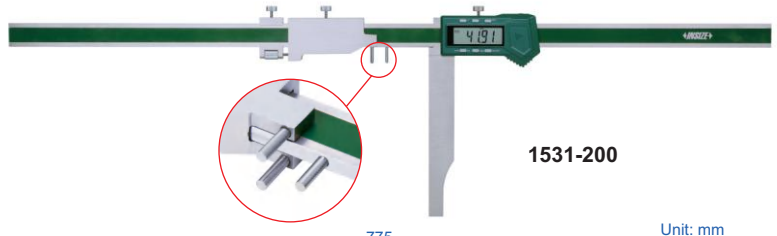
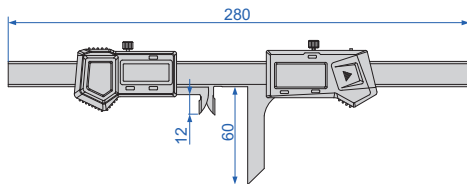

1531-200

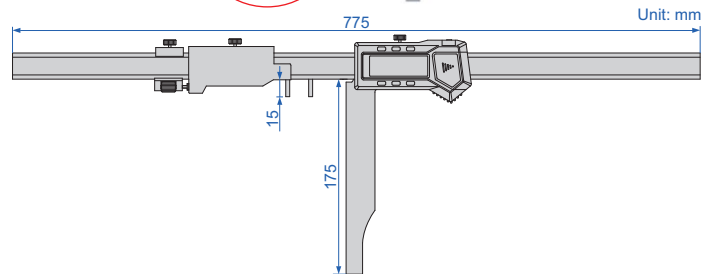

Unit: mm

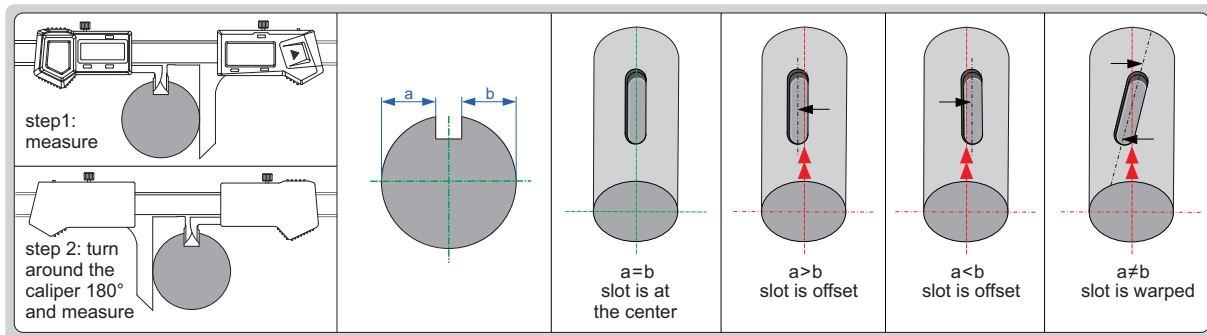

DATA OUTPUT



- Non waterproof
- Used to measure the symmetry of shaft keyways
- Resolution: 0.01mm/0.0005"
- Buttons: on/off, zero, mm/inch
- Automatic power off, move the digital unit to turn on power
- Battery CR2032, data output
- Made of stainless steel
- Optional accessory: wireless transmitter code **7315-22** (receiver is needed) page 5, bluetooth transmitter code **7214-22** page 11, data output cable code **7302-22** page 20

Code	Width of keyway	Diameter of shaft	Accuracy	Remark
1531-60	6-45mm	Ø10-120mm	±0.05mm	can measure keyway width
1531-200	3-250mm	Ø6-350mm	±0.05mm	cannot measure keyway width



DATA
OUTPUT

DIGITAL KEYWAY DEPTH GAUGE

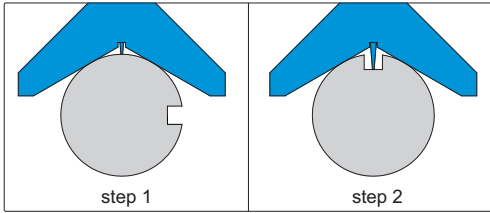

- Measure keyway depth of cylindrical workpieces with diameter $\varnothing 10-100\text{mm}$
- Button function: on/off, zero, inch/metric conversion, absolute/incremental measurement, data preset, measuring direction change
- CR2032 battery, automatic power off (time is adjustable)
- Data output
- Stainless steel base
- Pointed tip
- Optional accessory:
wireless transmitter code **7315-50M** (receiver is needed) page 6,
bluetooth transmitter code **7214-50M** page 12,
data output cable code **7302-40M** page 21



2182-25

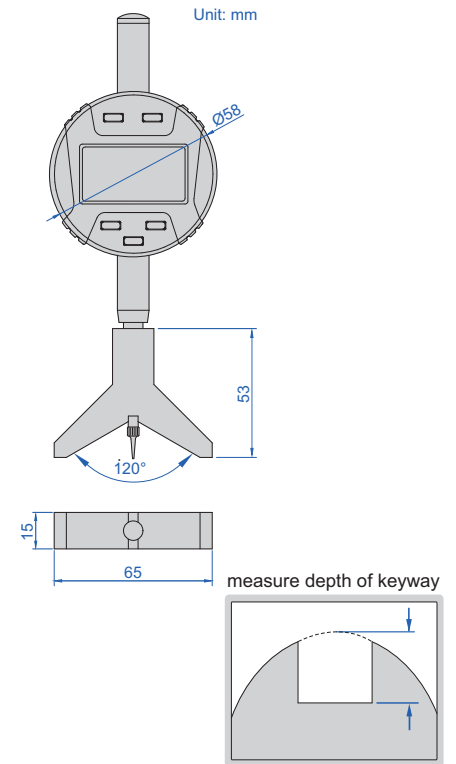

Code	Range	Resolution	Accuracy
2182-25	0-25.4mm/0-1"	0.01mm/0.0005"	$\pm 0.02\text{mm}$

9



DIAL KEYWAY DEPTH GAUGE

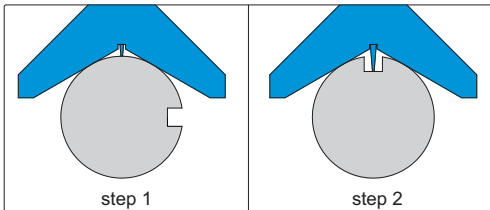

- Measure keyway depth of cylindrical workpieces with diameter $\varnothing 10-100\text{mm}$
- Stainless steel base
- Pointed tip



2189-30

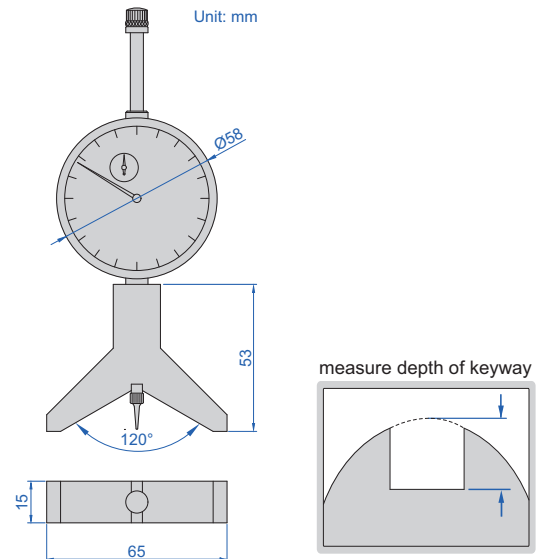

Code	Range	Graduation	Accuracy
2189-30	0-30mm	0.01mm	$\pm 0.03\text{mm}$

measure width of keyway

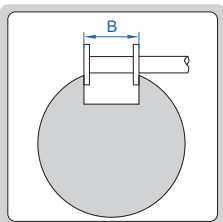

GROOVE MICROMETERS



3287-50B

REFER TO PAGE 153
FOR DETAILS

CHAMFER GAUGES

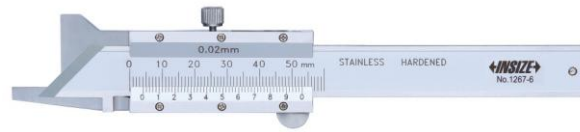

1267-6

- Measure 30°/45°/60° chamfer dimension
- Graduation: 0.02mm
- Made of stainless steel
- Satin chrome plated reading surface

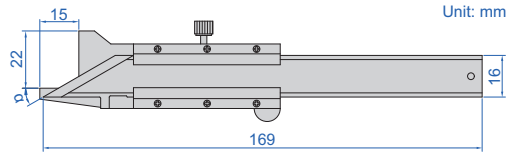

Code	Range	Accuracy	Chamfer (α)	$\varnothing D$
1267-6	0-10mm	$\pm 0.06\text{mm}$	45°	7mm
1267-63	0-10mm	$\pm 0.06\text{mm}$	30°	8mm
1267-66	0-10mm	$\pm 0.06\text{mm}$	60°	7mm

for internal chamfer measurement, diameter should be larger than $\varnothing D$

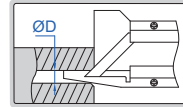

measure chamfer dimension

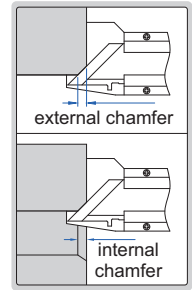

9

DIGITAL CHAMFER GAUGES

DATA OUTPUT



1180-6

- Non waterproof
- Measure 15°/20°/30°/45°/60° chamfer dimension
- Resolution: 0.01mm/0.0005"
- Buttons: on/off, zero, mm/inch
- Automatic power off, move the digital unit to turn on power
- Battery CR2032
- Data output
- Made of stainless steel

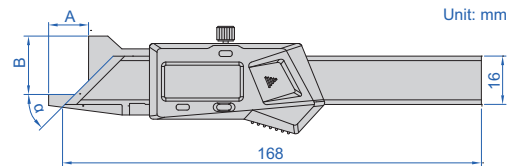

for internal chamfer measurement, diameter should be larger than $\varnothing D$

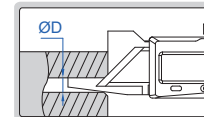

With data interface (optional data output cable: code 7315-25 receiver is needed page 5, 7214-25 page 11, 7302-21 page 20)

Code	Range	Accuracy	Chamfer (α)	A	B	$\varnothing D$
1180-6	0-10mm/0-0.39"	$\pm 0.06\text{mm}$	45°	15mm	22mm	7mm
1180-61	0-10mm/0-0.39"	$\pm 0.06\text{mm}$	15°	33mm	20mm	11mm
1180-62	0-10mm/0-0.39"	$\pm 0.06\text{mm}$	20°	33mm	20mm	11mm
1180-63	0-10mm/0-0.39"	$\pm 0.06\text{mm}$	30°	15mm	22mm	8mm
1180-66	0-10mm/0-0.39"	$\pm 0.06\text{mm}$	60°	14mm	21mm	7mm

Built-in wireless (receiver code 7315-2/3/6/7/8/9 is needed)

Code	Range	Accuracy	Chamfer (α)	A	B	$\varnothing D$
1180-6WL	0-10mm/0-0.39"	$\pm 0.06\text{mm}$	45°	15mm	22mm	7mm
1180-61WL	0-10mm/0-0.39"	$\pm 0.06\text{mm}$	15°	33mm	20mm	11mm
1180-62WL	0-10mm/0-0.39"	$\pm 0.06\text{mm}$	20°	33mm	20mm	11mm
1180-63WL	0-10mm/0-0.39"	$\pm 0.06\text{mm}$	30°	15mm	22mm	8mm
1180-66WL	0-10mm/0-0.39"	$\pm 0.06\text{mm}$	60°	14mm	21mm	7mm

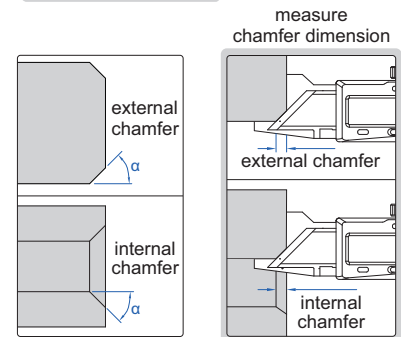

CHAMFER GAUGE

for internal chamfer measurement, diameter should be larger than $\varnothing D$

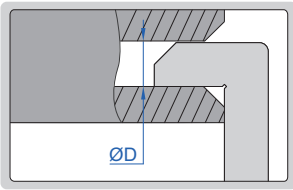

4844-1

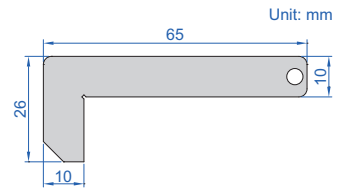

- To measure internal and external chamfers
- Made of stainless steel

Code	Graduation	Accuracy	$\varnothing D$
4844-1	0.5mm	$\pm 0.25\text{mm}$	11mm

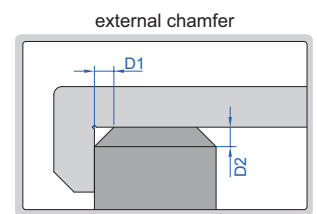
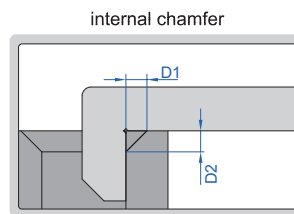

ATTENTION: CHAMFER OF HOLES CANNOT BE MEASURED

DATA OUTPUT

DIRECT READING, CALCULATION IS NOT REQUIRED

DIGITAL CHAMFER GAUGES



1537-20

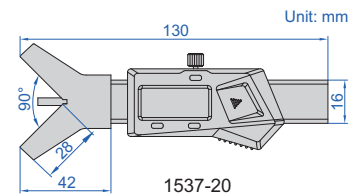

1537-8

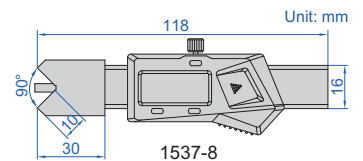

- Non waterproof
- Measure 45° chamfer length
- Resolution: 0.01mm/0.0005"
- Buttons: on/off, zero, mm/inch
- Automatic power off, move the digital unit to turn on power
- Battery CR2032
- Data output
- Made of stainless steel
- Supplied with pin gauge for zero setting
- Optional accessory: wireless transmitter code **7315-25** (receiver is needed) page 5, bluetooth transmitter code **7214-25** page 11, data output cable code **7302-21** page 20

Code	Range	Accuracy
1537-20	0-20mm/0-0.787"	$\pm 0.05\text{mm}$
1537-8	0-8mm/0-0.315"	$\pm 0.05\text{mm}$

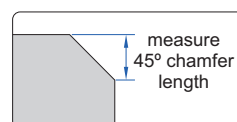

pin gauge (included)



1537-8 can measure small workpieces or workpieces with steps

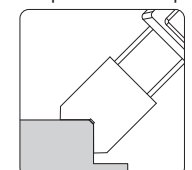

10

INDICATORS AND DIAL INDICATOR STANDS



Dial Test Indicators
Page 246-248



Styli For Dial Test Indicators
Page 248



Digital Indicators
Page 249-263



Zeroing Foot Switches
Page 257



High Precision Digital Indicators
Page 264-265



Digital Comparators
Page 266



Dial Indicators
Page 266-271



Points
Page 272-276



Backs
Page 277-278



Measuring Tools
Dynamometers
Page 279



Dial Indicator Testers
Page 279



Dial Test Indicator Holders
Page 280-281



Magnetic Stands
Page 282-287



Dial Indicator Stands
(non-magnetic)
Page 288-289



Dial Indicator Stands
Page 290-298

JEWELLED BEARING

INSPECTION CERTIFICATE

DIAL TEST INDICATORS

- Meet DIN2270 (except 2380-02, 2381-02, 2381-021)
- Jeweled bearing
- Carbide contact point
- Two measuring directions
- Anti magnetic body
- Supplied with two clamps: diameter Ø4mm and Ø8mm
- Optional accessory: styli (page 248)

clamp (included)

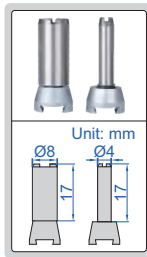

2380-08

POPULAR MODEL

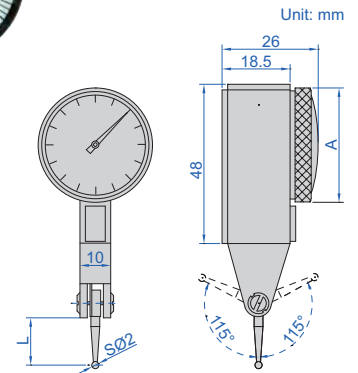

Code	Range	Graduation	Accuracy	Hysteresis	Dial reading	A	L
2380-08*	0.8mm	0.01mm	13µm	3µm	0-40-0	Ø30	13.5
2381-08*	0.8mm	0.01mm	13µm	3µm	0-40-0	Ø37	13.5
2380-02*	0.2mm	0.002mm	6µm	2µm	0-100-0	Ø30	12.5
2381-02*	0.2mm	0.002mm	6µm	2µm	0-100-0	Ø37	12.5
2381-021*	0.2mm	0.001mm	6µm	2µm	0-100-0	Ø37	12.5

*Supplied with manufacturer inspection certificate

JEWELLED BEARING

INSPECTION CERTIFICATE

INCH DIAL TEST INDICATORS

- Jeweled bearing
- Carbide contact point
- Two measuring directions
- Anti magnetic body
- Supplied with two clamps: 5/32" DIA and 3/8" DIA



2380-31

Code	Range	Graduation	Accuracy	Dial reading	A	L
2380-31*	0.03"	0.001"	±0.001"	0-15-0	1.181" DIA	0.50"
2380-35*	0.03"	0.0005"	±0.0005"	0-15-0	1.181" DIA	0.50"
2380-301*	0.008"	0.0001"	±0.0001"	0-40-0	1.181" DIA	0.563"
2381-31*	0.03"	0.001"	±0.001"	0-15-0	1.457" DIA	0.50"
2381-35*	0.03"	0.0005"	±0.0005"	0-15-0	1.457" DIA	0.50"
2381-301*	0.008"	0.0001"	±0.0001"	0-40-0	1.457" DIA	0.563"

*Supplied with manufacturer inspection certificate

clamp (included)

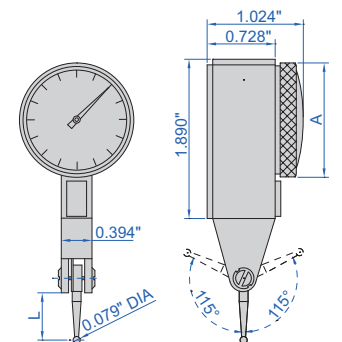
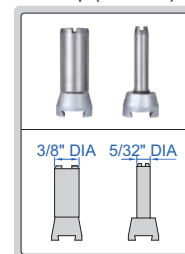

10

JEWELLED BEARING

INSPECTION CERTIFICATE

LONG STYLUS DIAL TEST INDICATOR

- Meet DIN2270
- Jeweled bearing
- Carbide contact point
- Two measuring directions
- Anti magnetic body
- Supplied with two clamps: diameter Ø4mm and Ø8mm
- Optional accessory: styli (page 248)



2383-08A

clamp (included)

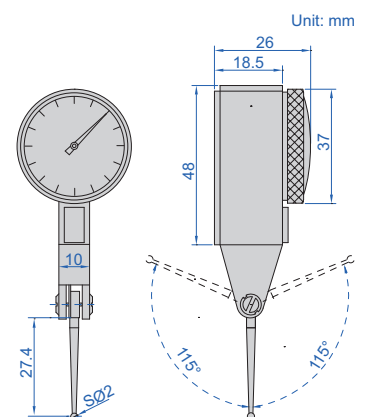
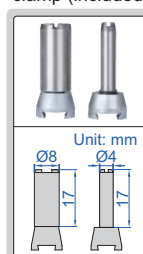

Code	Range	Graduation	Accuracy	Hysteresis	Dial reading
2383-08A*	0.8mm	0.01mm	13µm	3µm	0-40-0

*Supplied with manufacturer inspection certificate

VERTICAL TYPE DIAL TEST INDICATOR

- Meet DIN2270
- Jeweled bearing
- Carbide contact point
- Two measuring directions
- Anti magnetic body
- Supplied with two clamps: diameter Ø4mm and Ø8mm
- Optional accessory: styli (page 248)

clamp (included)

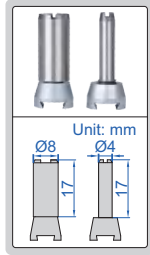

2398-08

INSPECTION CERTIFICATE

JEWELLED BEARING

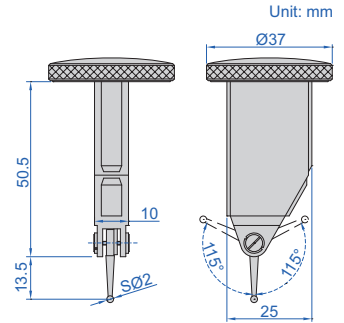

Code	Range	Graduation	Accuracy	Hysteresis	Dial reading
2398-08*	0.8mm	0.01mm	13µm	3µm	0-40-0

*Supplied with manufacturer inspection certificate

TILTED FACE TYPE DIAL TEST INDICATOR

- Meet DIN2270
- Jeweled bearing
- Carbide contact point
- Two measuring directions
- Anti magnetic body
- Supplied with two clamps: diameter Ø4mm and Ø8mm
- Optional accessory: styli (page 248)



2399-08

INSPECTION CERTIFICATE

JEWELLED BEARING

clamp (included)

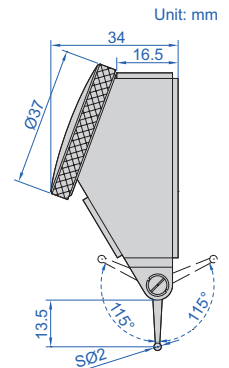
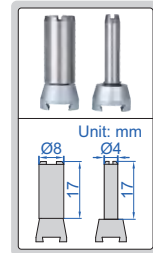

Code	Range	Graduation	Accuracy	Hysteresis	Dial reading
2399-08*	0.8mm	0.01mm	13µm	3µm	0-40-0

*Supplied with manufacturer inspection certificate

LARGE RANGE DIAL TEST INDICATOR

- Dial reading: 0-40-0
- Jeweled bearing
- Carbide contact point
- Two measuring directions
- Anti magnetic body
- Supplied with two clamps: diameter Ø4mm and Ø8mm
- Optional accessory: styli (page 248)



2386-16A

INSPECTION CERTIFICATE

JEWELLED BEARING

clamp (included)

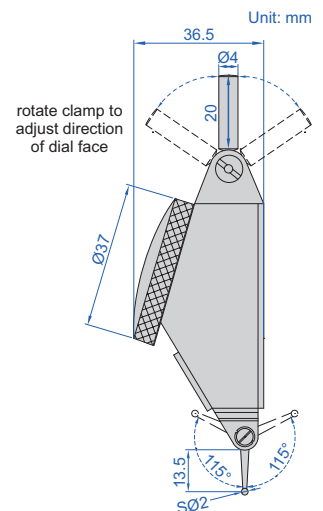
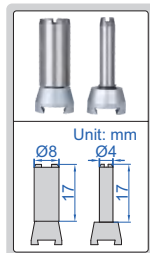

Code	Range	Graduation	Accuracy	Hysteresis
2386-16A*	1.6mm	0.01mm	25µm	8µm

*Supplied with manufacturer inspection certificate

JEWELLED BEARING

INSPECTION CERTIFICATE

LARGE RANGE VERTICAL TYPE DIAL TEST INDICATOR

- Dial Reading: 0-40-0
- Jeweled bearing
- Carbide contact point
- Two measuring directions
- Anti magnetic body
- Supplied with two clamps: diameter Ø4mm and Ø8mm
- Optional accessory: styli (page 248)

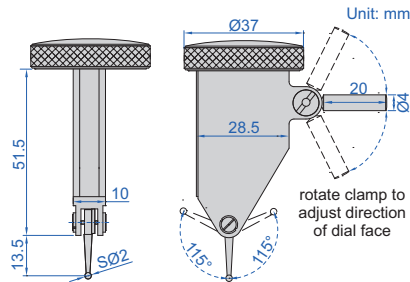

2480-16

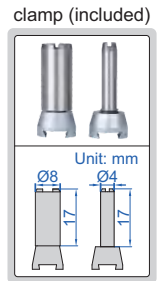

Code	Range	Graduation	Accuracy	Hysteresis
2480-16*	1.6mm	0.01mm	18µm	3µm

* Supplied with manufacturer inspection certificate

CLAMPS FOR DIAL TEST INDICATORS



6298-1



6298-2



Code	ØD
6298-1	Ø4mm
6298-2	Ø8mm

10

STYLI FOR DIAL TEST INDICATORS

Code	For dial test indicator	Material of contact point	L	D
6284-1	2380-08	carbide	13.5mm	SØ1mm
6284-31		ruby	13.5mm	SØ1mm
6284-3	2381-08	carbide	13.5mm	SØ2mm
6284-4		ruby	13.5mm	SØ2mm
6284-8	2399-08	carbide	13.5mm	SØ3mm
6284-21		carbide	12.5mm	SØ1mm
6284-22	2380-02	carbide	12.5mm	SØ2mm
6284-24		ruby	12.5mm	SØ2mm
6284-23	2381-021	carbide	12.5mm	SØ3mm
6284-61	2386-16A	carbide	13.5mm	SØ1mm
6284-62		carbide	13.5mm	SØ2mm
6284-63		ruby	13.5mm	SØ2mm
6284-64	2480-16	carbide	13.5mm	SØ3mm
6284-81	2383-08A	carbide	27.4mm	SØ1mm
6284-82		carbide	27.4mm	SØ2mm
6284-83		ruby	27.4mm	SØ2mm
6284-84		carbide	27.4mm	SØ3mm



6284-3

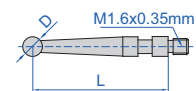

DIGITAL INDICATORS (STANDARD TYPE)

DATA
OUTPUT

INSPECTION
CERTIFICATE

POPULAR
MODEL



2112-10



2112-251



2112-25P



2112-501

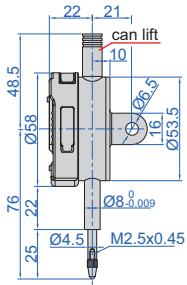

2112-10
2112-101

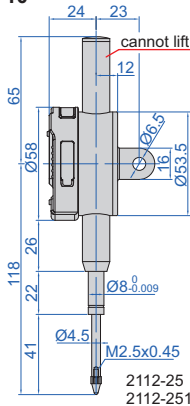

2112-25
2112-251

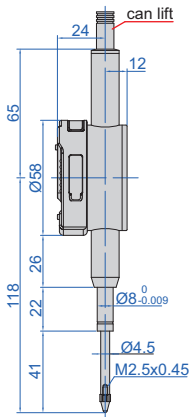

2112-25P
2112-251P

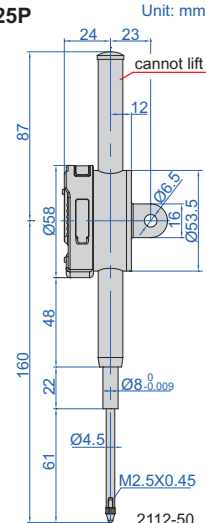

Unit: mm

2112-50
2112-501

- Button function: on/off, inch/mm, zero, data preset, change measuring direction, absolute/incremental measurement
- Switchable high/low frequency measurement mode, high frequency mode is suitable for high speed moving of spindle and has large power consumption, low power consumption in low frequency mode
- Keep preset data in memory after restart
- CR2032 battery, automatic power off (time is adjustable)
- Data output
- Optional accessory: wireless transmitter code **7315-50M** (receiver is needed) page 6, bluetooth transmitter code **7214-50M** page 12, data output cable code **7302-40M** page 21, **7305-40M** page 17, backs (page 277~278), contact points (page 272~276)

Resolution 0.001mm/0.00005"

Code	Range	Accuracy	Hysteresis	Maximum measuring force	Cap	Remark
2112-101F*	12.7mm/0.5"	5µm	2µm	1.5N	can lift	flat back
2112-251F*	25.4mm/1"	5µm	3µm	2.2N	cannot lift	flat back
2112-501F*	50.8mm/2"	6µm	3µm	2.5N	cannot lift	flat back
2112-101*	12.7mm/0.5"	5µm	2µm	1.5N	can lift	lug back
2112-251*	25.4mm/1"	5µm	3µm	2.2N	cannot lift	lug back
2112-501*	50.8mm/2"	6µm	3µm	2.5N	cannot lift	lug back
2112-251P*	25.4mm/1"	5µm	3µm	2.2N	can lift	flat back
2112-501P*	50.8mm/2"	6µm	3µm	2.5N	can lift	flat back

Resolution 0.01mm/0.0005"

Code	Range	Accuracy	Hysteresis	Maximum measuring force	Cap	Remark
2112-10F*	12.7mm/0.5"	20µm	10µm	1.5N	can lift	flat back
2112-25F*	25.4mm/1"	20µm	10µm	2.2N	cannot lift	flat back
2112-50F*	50.8mm/2"	30µm	10µm	2.5N	cannot lift	flat back
2112-10*	12.7mm/0.5"	20µm	10µm	1.5N	can lift	lug back
2112-25*	25.4mm/1"	20µm	10µm	2.2N	cannot lift	lug back
2112-50*	50.8mm/2"	30µm	10µm	2.5N	cannot lift	lug back
2112-25P*	25.4mm/1"	20µm	10µm	2.2N	can lift	flat back
2112-50P*	50.8mm/2"	30µm	10µm	2.5N	can lift	flat back

*Supplied with manufacturer inspection certificate

2112-251P/501P/25P/50P



spindle lift knob is included



DATA OUTPUT

INSPECTION CERTIFICATE

METRIC DIGITAL INDICATORS

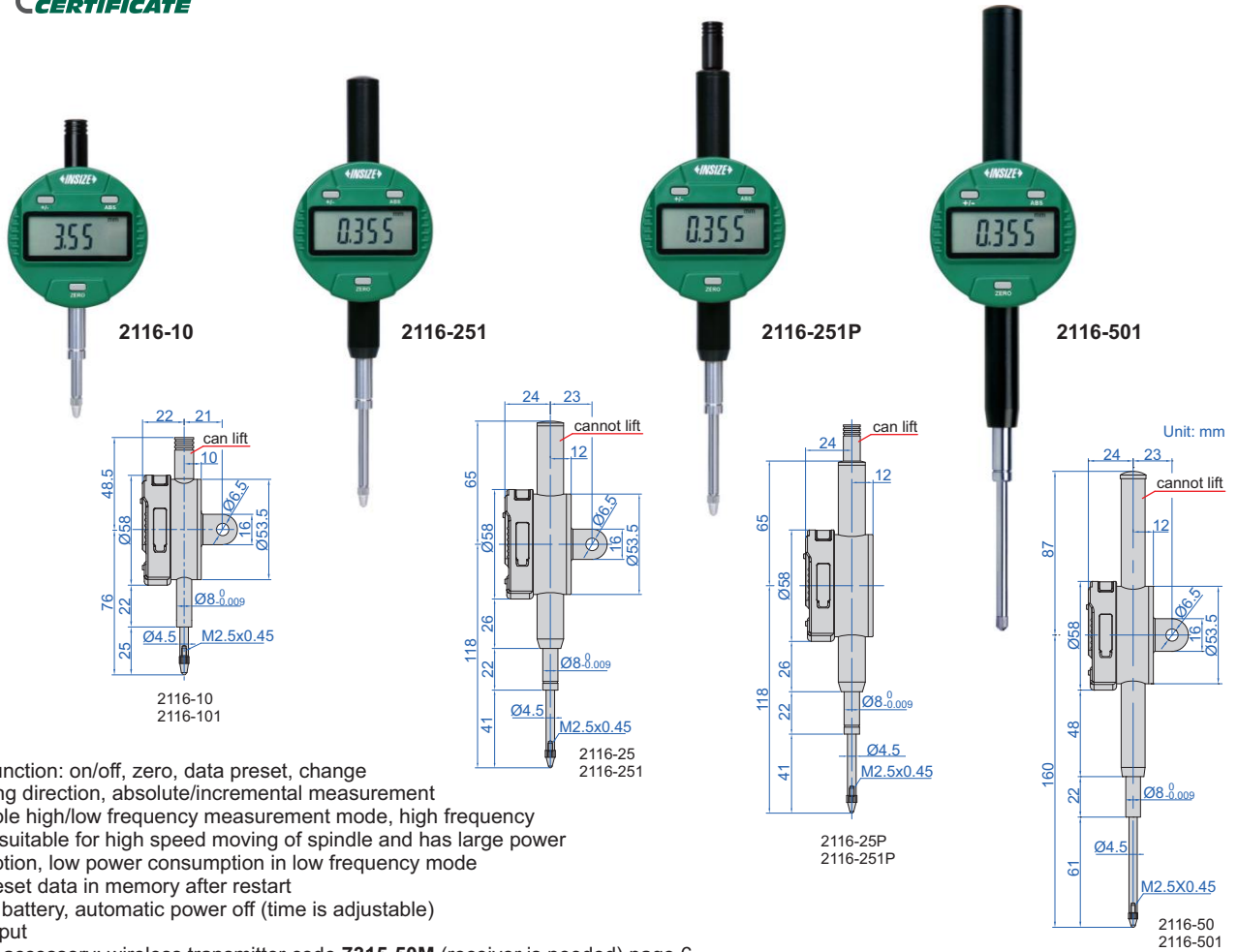

- Button function: on/off, zero, data preset, change measuring direction, absolute/incremental measurement
- Switchable high/low frequency measurement mode, high frequency mode is suitable for high speed moving of spindle and has large power consumption, low power consumption in low frequency mode
- Keep preset data in memory after restart
- CR2032 battery, automatic power off (time is adjustable)
- Data output
- Optional accessory: wireless transmitter code **7315-50M** (receiver is needed) page 6, bluetooth transmitter code **7214-50M** page 12, data output cable code **7302-40M** page 21, **7305-40M** page 17, backs (page 277~278), contact points (page 272~276)

Resolution 0.001mm

Code	Range	Accuracy	Hysteresis	Maximum measuring force	Cap	Remark
2116-101F*	12.7mm	5µm	2µm	1.5N	can lift	flat back
2116-251F*	25.4mm	5µm	3µm	2.2N	cannot lift	flat back
2116-501F*	50.8mm	6µm	3µm	2.5N	cannot lift	flat back
2116-101*	12.7mm	5µm	2µm	1.5N	can lift	lug back
2116-251*	25.4mm	5µm	3µm	2.2N	cannot lift	lug back
2116-501*	50.8mm	6µm	3µm	2.5N	cannot lift	lug back
2116-251P*	25.4mm	5µm	3µm	2.2N	can lift	flat back
2116-501P*	50.8mm	6µm	3µm	2.5N	can lift	flat back

Resolution 0.01mm

Code	Range	Accuracy	Hysteresis	Maximum measuring force	Cap	Remark
2116-10F*	12.7mm	20µm	10µm	1.5N	can lift	flat back
2116-25F*	25.4mm	20µm	10µm	2.2N	cannot lift	flat back
2116-50F*	50.8mm	30µm	10µm	2.5N	cannot lift	flat back
2116-10*	12.7mm	20µm	10µm	1.5N	can lift	lug back
2116-25*	25.4mm	20µm	10µm	2.2N	cannot lift	lug back
2116-50*	50.8mm	30µm	10µm	2.5N	cannot lift	lug back
2116-25P*	25.4mm	20µm	10µm	2.2N	can lift	flat back
2116-50P*	50.8mm	30µm	10µm	2.5N	can lift	flat back

* Supplied with manufacturer inspection certificate

2116-251P/501P/25P/50P



spindle lift knob is included



DIGITAL INDICATORS (ADVANCED TYPE)



DATA OUTPUT

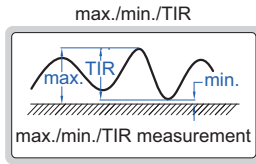
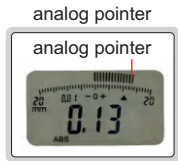
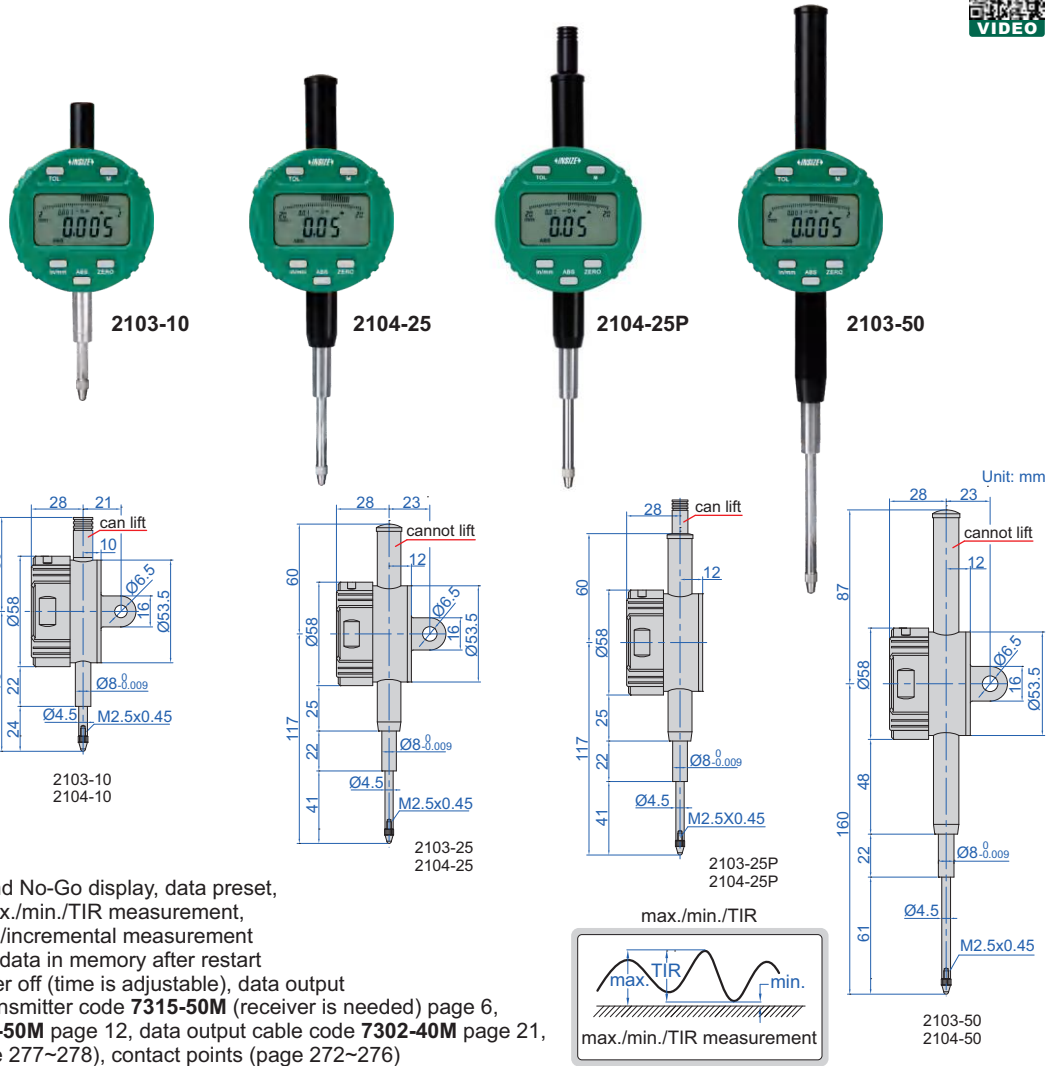

- Reading in digital and analog
- Display can be rotated by 320°
- Button function: tolerance Go and No-Go display, data preset, measuring direction change, max./min./TIR measurement, inch/metric conversion, absolute/incremental measurement
- Keep preset data and tolerance data in memory after restart
- CR2032 battery, automatic power off (time is adjustable), data output
- Optional accessory: wireless transmitter code **7315-50M** (receiver is needed) page 6, bluetooth transmitter code **7214-50M** page 12, data output cable code **7302-40M** page 21, **7305-40M** page 17, backs (page 277~278), contact points (page 272~276)

Resolution 0.001mm/0.00005"

Code	Range	Accuracy	Hysteresis	Maximum measuring force	Cap	Remark
2103-10F*	12.7mm/0.5"	5µm	2µm	1.5N	can lift	flat back
2103-25F*	25.4mm/1"	5µm	3µm	2.2N	cannot lift	flat back
2103-50F*	50.8mm/2"	6µm	3µm	2.5N	cannot lift	flat back
2103-10*	12.7mm/0.5"	5µm	2µm	1.5N	can lift	lug back
2103-25*	25.4mm/1"	5µm	3µm	2.2N	cannot lift	lug back
2103-50*	50.8mm/2"	6µm	3µm	2.5N	cannot lift	lug back
2103-25P*	25.4mm/1"	5µm	3µm	2.2N	can lift	flat back
2103-50P*	50.8mm/2"	6µm	3µm	2.5N	can lift	flat back

alarm when over tolerance

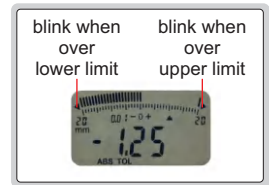

Resolution 0.01mm/0.0005"

Code	Range	Accuracy	Hysteresis	Maximum measuring force	Cap	Remark
2104-10F*	12.7mm/0.5"	20µm	10µm	1.5N	can lift	flat back
2104-25F*	25.4mm/1"	20µm	10µm	2.2N	cannot lift	flat back
2104-50F*	50.8mm/2"	30µm	10µm	2.5N	cannot lift	flat back
2104-10*	12.7mm/0.5"	20µm	10µm	1.5N	can lift	lug back
2104-25*	25.4mm/1"	20µm	10µm	2.2N	cannot lift	lug back
2104-50*	50.8mm/2"	30µm	10µm	2.5N	cannot lift	lug back
2104-25P*	25.4mm/1"	20µm	10µm	2.2N	can lift	flat back
2104-50P*	50.8mm/2"	30µm	10µm	2.5N	can lift	flat back

2103-25P/50P
2104-25P/50P



*Supplied with manufacturer inspection certificate



DIGITAL INDICATORS (WITH TRANSMISSION BUTTON AND SIGNAL LIGHT)



DATA OUTPUT



2138-10

2139-25

2139-25P

2138-50

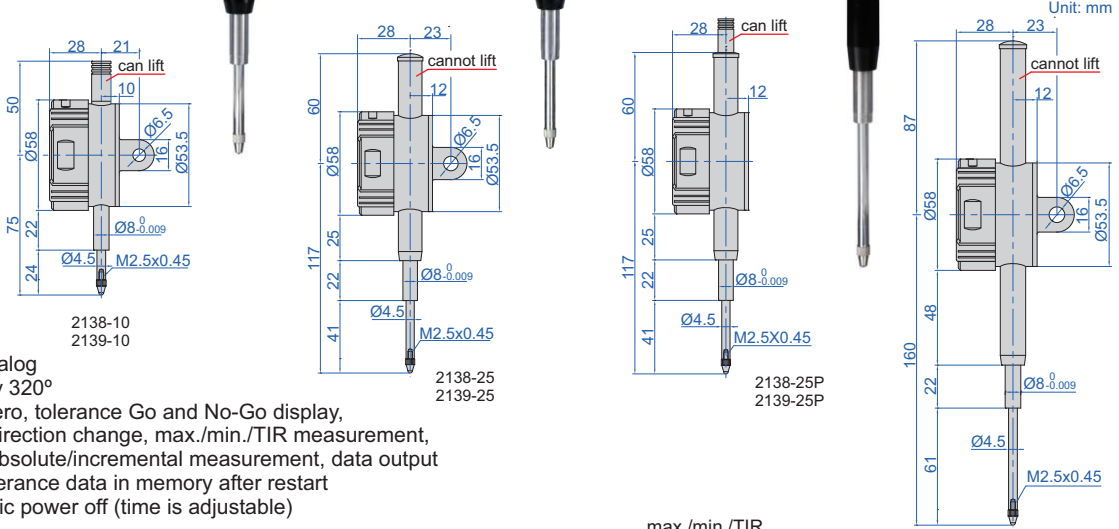

- Reading in digital and analog
- Display can be rotated by 320°
- Button function: on/off, zero, tolerance Go and No-Go display, data preset, measuring direction change, max./min./TIR measurement, inch/metric conversion, absolute/incremental measurement, data output
- Keep preset data and tolerance data in memory after restart
- CR2032 battery, automatic power off (time is adjustable)
- Data output
- Optional accessory:
 - flat back: wireless transmitter code **7315-51** (receiver is needed) page 6, bluetooth transmitter code **7214-51** page 12, data output cable code **7302-40M** page 21, **7305-40M** page 17;
 - lug back: wireless transmitter code **7315-50M** (receiver is needed) page 6, bluetooth transmitter code **7214-50M** page 12, data output cable code **7302-40M** page 21, **7305-40M** page 17, backs (page 277~278), contact points (page 272~276)

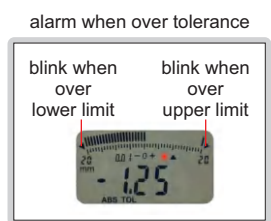
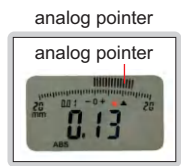
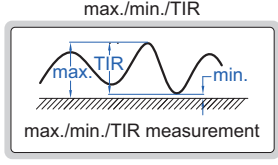

Resolution 0.001mm/0.0005"

Code	Range	Accuracy	Hysteresis	Maximum measuring force	Cap	Remark
2138-10F*	12.7mm/0.5"	5µm	2µm	1.5N	can lift	flat back
2138-25F*	25.4mm/1"	5µm	3µm	2.2N	cannot lift	flat back
2138-50F*	50.8mm/2"	6µm	3µm	2.5N	cannot lift	flat back
2138-10*	12.7mm/0.5"	5µm	2µm	1.5N	can lift	lug back
2138-25*	25.4mm/1"	5µm	3µm	2.2N	cannot lift	lug back
2138-50*	50.8mm/2"	6µm	3µm	2.5N	cannot lift	lug back
2138-25P*	25.4mm/1"	5µm	3µm	2.2N	can lift	flat back
2138-50P*	50.8mm/2"	6µm	3µm	2.5N	can lift	flat back

Resolution 0.01mm/0.0005"

Code	Range	Accuracy	Hysteresis	Maximum measuring force	Cap	Remark
2139-10F*	12.7mm/0.5"	20µm	10µm	1.5N	can lift	flat back
2139-25F*	25.4mm/1"	20µm	10µm	2.2N	cannot lift	flat back
2139-50F*	50.8mm/2"	30µm	10µm	2.5N	cannot lift	flat back
2139-10*	12.7mm/0.5"	20µm	10µm	1.5N	can lift	lug back
2139-25*	25.4mm/1"	20µm	10µm	2.2N	cannot lift	lug back
2139-50*	50.8mm/2"	30µm	10µm	2.5N	cannot lift	lug back
2139-25P*	25.4mm/1"	20µm	10µm	2.2N	can lift	flat back
2139-50P*	50.8mm/2"	30µm	10µm	2.5N	can lift	flat back

* Supplied with manufacturer inspection certificate



WATERPROOF DIGITAL INDICATORS

WATERPROOF

DATA
OUTPUT

INSPECTION
CERTIFICATE



2115-10

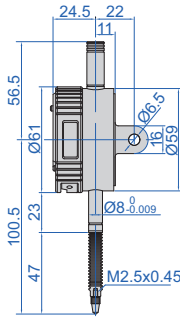

2115-10
2115-101



2115-25

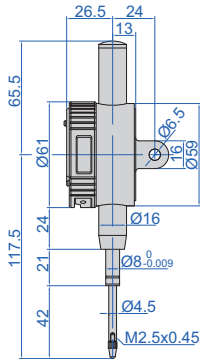

2115-25
2115-251



2115-50

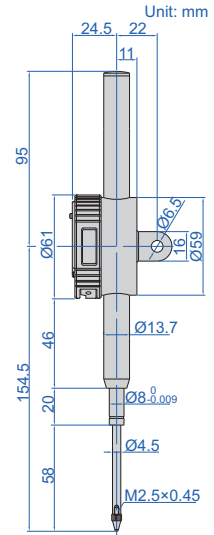

2115-50
2115-501

- Dust/waterproof
- Button function: on/off, zero, mm/inch, data preset, tolerance, change measuring direction, max./min./TIR measurement, absolute/incremental measurement
- Keep preset data and tolerance data in memory after restart
- CR2032 battery, automatic power off
- Data output
- Optional accessory: wireless transmitter code **7315-50M** (receiver is needed) page 6, bluetooth transmitter code **7214-50M** page 12, data output cable code **7302-40M** page 21, **7305-40M** page 17, backs (page 277~278), contact points (page 272~276)

spindle lift knob is included (except **2115-101/101F**, **2115-10/10F**)



max./min./TIR

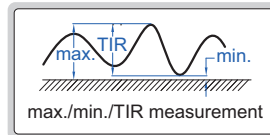

alarm when over tolerance

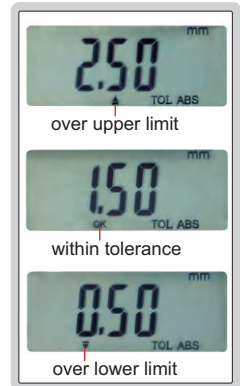

Resolution 0.001mm/0.00005"

Code	Range	Dust/waterproof	Accuracy	Hysteresis	Maximum measuring force	Cap	Remark
2115-101 *	12.7mm/0.5"	IP65	5µm	2µm	1.5N	cannot lift	lug back
2115-251 *	25.4mm/1"	IP54	5µm	3µm	2.2N	cannot lift	lug back
2115-501 *	50.8mm/2"	IP54	6µm	3µm	2.5N	cannot lift	lug back
2115-101F *	12.7mm/0.5"	IP65	5µm	2µm	1.5N	cannot lift	flat back
2115-251F *	25.4mm/1"	IP54	5µm	3µm	2.2N	cannot lift	flat back
2115-501F *	50.8mm/2"	IP54	6µm	3µm	2.5N	cannot lift	flat back

Resolution 0.01mm/0.0005"

Code	Range	Dust/waterproof	Accuracy	Hysteresis	Maximum measuring force	Cap	Remark
2115-10 *	12.7mm/0.5"	IP65	20µm	10µm	1.5N	cannot lift	lug back
2115-25 *	25.4mm/1"	IP54	20µm	10µm	2.2N	cannot lift	lug back
2115-50 *	50.8mm/2"	IP54	30µm	10µm	2.5N	cannot lift	lug back
2115-10F *	12.7mm/0.5"	IP65	20µm	10µm	1.5N	cannot lift	flat back
2115-25F *	25.4mm/1"	IP54	20µm	10µm	2.2N	cannot lift	flat back
2115-50F *	50.8mm/2"	IP54	30µm	10µm	2.5N	cannot lift	flat back

* Supplied with manufacturer inspection certificate



DATA
OUTPUT

INSPECTION
CERTIFICATE

ADJUSTABLE COEFFICIENT DIGITAL INDICATORS

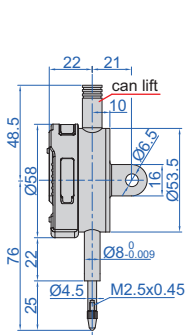

2501-10

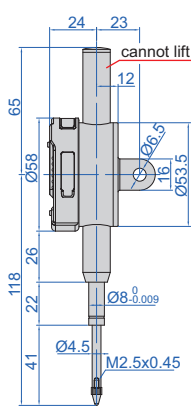

2501-25

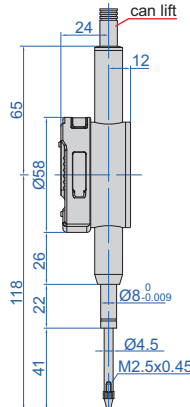

2501-25P

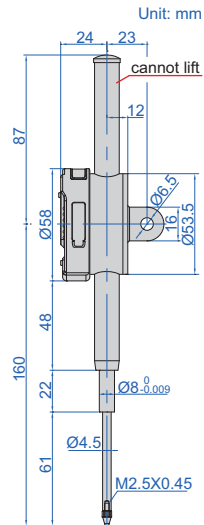

2501-50

- DISPLAY READING = COEFFICIENT X SPINDLE MOVEMENT.
The coefficient can be adjusted from 0 to 9.9999.
For example, coefficient is 4.5562, spindle moves 3.60mm, display reading is $4.5562 \times 3.60 = 16.40\text{mm}$
- Button function: on/off, zero, data preset, inch/mm, coefficient set, measuring direction change
- Switchable high/low frequency measurement mode, high frequency mode is suitable for high speed moving of spindle and has large power consumption, low power consumption in low frequency mode
- Keep preset data in memory after restart
- CR2032 battery, automatic power off (time is adjustable)
- Data output
- Optional accessory:
wireless transmitter code **7315-50M** (receiver is needed) page 6,
bluetooth transmitter code **7214-50M** page 12,
data output cable code **7302-40M** page 21, **7305-40M** page 17,
backs (page 277-278), contact points (page 272-276)

spindle lift knob is included



Resolution 0.01mm/0.0005"

Code	Range	Accuracy	Hysteresis	Maximum measuring force	Cap	Remark
2501-10*	12.7mm/0.5"	20µm	10µm	1.5N	can lift	lug back
2501-25*	25.4mm/1"	20µm	10µm	2.2N	cannot lift	lug back
2501-50*	50.8mm/2"	30µm	10µm	2.5N	cannot lift	lug back
2501-10F*	12.7mm/0.5"	20µm	10µm	1.5N	can lift	flat back
2501-25F*	25.4mm/1"	20µm	10µm	2.2N	cannot lift	flat back
2501-50F*	50.8mm/2"	30µm	10µm	2.5N	cannot lift	flat back
2501-25P*	25.4mm/1"	20µm	10µm	2.2N	can lift	flat back
2501-50P*	50.8mm/2"	30µm	10µm	2.5N	can lift	flat back

* Supplied with manufacturer inspection certificate

2501-25P/50P



DIGITAL INDICATORS FOR BORE GAUGES (WITH TRANSMISSION BUTTON AND SIGNAL LIGHT)



THE ORIGINAL DATA
REMAINS AFTER POWER OFF



DATA
OUTPUT

- Specially designed for bore gauges
- The minimum value tracking function can find the diameter automatically
- Read the diameter directly, after inputting the size of setting ring
- Reading in digital and analog
- Display can be rotated by 320°
- Button function: on/off, minimum value tracking, calibration, data preset, inch/metric conversion
- Data remains after power off, no need to recalibrate after power on
- CR2032 battery, automatic power off (time is adjustable)
- Data output
- Optional accessory: wireless transmitter code **7315-51B** (receiver is needed) page 7, bluetooth transmitter code **7214-51B** page 12, data output cable code **7302-40M** page 21, backs (page 277~278), contact points (page 272~276), spindle lift knob (code **7332**)



2108-10F

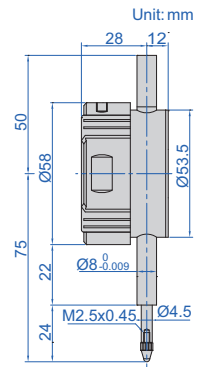
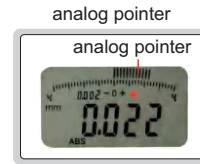

read the diameter directly, after inputting the size of setting ring.

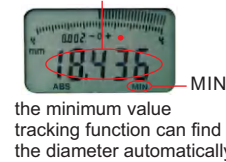

Code	Range	Resolution	Accuracy	Hysteresis	Maximum measuring force	Cap	Remark
2108-10F *	12.7mm/0.5"	0.002mm/0.0001" (can switch to: 0.01mm/0.0005")	20µm	10µm	1.5N	cannot lift	flat back
2108-101F *	12.7mm/0.5"	0.001mm/0.00005"	5µm	2µm	1.5N	cannot lift	flat back

*Supplied with manufacturer inspection certificate

WATERPROOF DIGITAL INDICATORS FOR BORE GAUGES



IP54
WATERPROOF

DATA
OUTPUT

THE ORIGINAL DATA
REMAINS AFTER POWER OFF

- Specially designed for bore gauges
- The minimum value tracking function can find the diameter automatically
- Read the diameter directly, after inputting the size of setting ring
- Button function: on/off, minimum value tracking, calibration, data preset, inch/metric conversion
- Data remains after power off, no need to recalibrate after power on
- CR2032 battery, automatic power off (time is adjustable)
- Data output
- Optional accessory: wireless transmitter code **7315-51B** (receiver is needed) page 7, bluetooth transmitter code **7214-51B** page 12, data output cable code **7302-40M** page 21, backs (page 277~278), contact points (page 272~276), spindle lift knob (code **7332**)

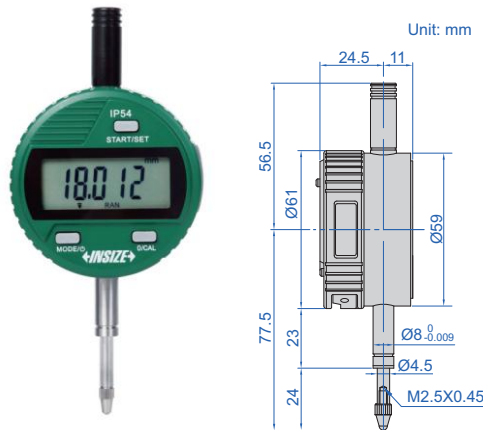

2137-10F

read the diameter directly, after inputting the size of setting ring.



the minimum value tracking function can find the diameter automatically.

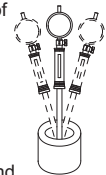

Code	Range	Resolution	Accuracy	Hysteresis	Maximum measuring force	Cap	Remark
2137-10F *	12.7mm/0.5"	0.002mm/0.0001" (can switch to: 0.01mm/0.0005")	20µm	10µm	1.5N	cannot lift	flat back
2137-101F *	12.7mm/0.5"	0.001mm/0.00005"	5µm	2µm	1.5N	cannot lift	flat back

*Supplied with manufacturer inspection certificate

DATA
OUTPUT

INSPECTION
CERTIFICATE

DIGITAL INDICATORS WITH LIFTING LEVER



2109-10

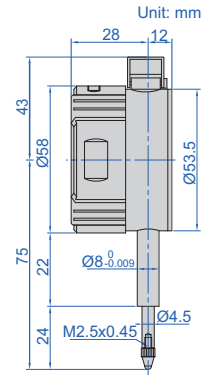

- Reading in digital and analog
- Display can be rotated by 320°
- Button function: tolerance Go and No-Go display, data preset, measuring direction change, max./min./TIR measurement, inch/metric conversion, absolute/incremental measurement
- Keep preset data and tolerance data in memory after restart
- CR2032 battery, automatic power off (time is adjustable)
- Data output
- Optional accessory:
 - wireless transmitter code **7315-50M** (receiver is needed) page 6,
 - bluetooth transmitter code **7214-50M** page 12,
 - data output cable code **7302-40M** page 21, **7305-40M** page 17,
 - backs (page 277~278), contact points (page 272~276)

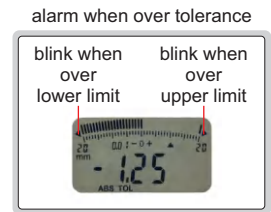
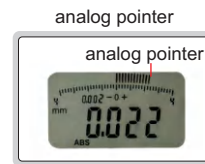

Code	Range	Resolution	Accuracy	Hysteresis	Maximum measuring force	Remark
2109-10*	10mm/0.4"	0.01mm/0.0005"	20µm	10µm	1.5N	flat back
2109-101*	10mm/0.4"	0.001mm/0.00005"	5µm	2µm	1.5N	flat back

* Supplied with manufacturer inspection certificate

10

DATA
OUTPUT

INSPECTION
CERTIFICATE

COMPACT DIGITAL INDICATORS

- Button function:
 - in/mm: short press for inch/metric conversion
long press to change measuring direction
 - ABS: short press for absolute/incremental measurement
long press to preset data
 - 0/OFF: short press to turn on when power is off
short press to set zero when power is on
long press to turn off
- Keep preset data in memory after restart
- CR1632 battery, automatic power off
- Data output
- Optional accessory:
 - wireless transmitter code **7315-50M** (receiver is needed) page 6,
 - bluetooth transmitter code **7214-50M** page 12,
 - data output cable code **7302-40M** page 21, **7305-40M** page 17,
 - backs (page 277~278), contact points (page 272~276)



2114-51F

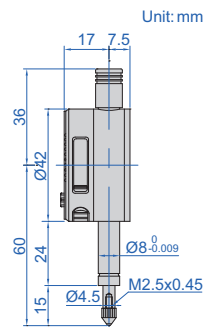

Code	Range	Resolution	Accuracy	Hysteresis	Maximum measuring force	Cap	Remark
2114-5F*	5mm/0.2"	0.01mm/0.0005"	20µm	10µm	1.5N	can lift	flat back
2114-51F*	5mm/0.2"	0.001mm/0.00005"	5µm	2µm	1.5N	can lift	flat back

* Supplied with manufacturer inspection certificate

BACK PLUNGER TYPE DIGITAL INDICATORS

INSPECTION CERTIFICATE

DATA OUTPUT



alarm when over tolerance

blink when over lower limit blink when over upper limit



analog pointer

analog pointer

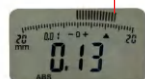

- Display can rotate 320°, and display direction is changeable
- Reading in digital and analog
- Button function: tolerance Go and No-Go display, data preset, measuring direction change, max./min./TIR measurement, inch/metric conversion, absolute/incremental measurement
- Keep preset data and tolerance data in memory after restart
- CR2032 battery, automatic power off (time is adjustable)
- Data output
- Optional accessory: wireless transmitter code **7315-50M** (receiver is needed) page 6, bluetooth transmitter code **7214-50M** page 12, data output cable code **7302-40M** page 21, **7305-40M** page 17, backs (page 277~278), contact points (page 272~276)



2118-10

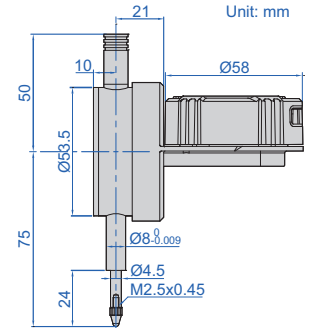

display can rotate 320°



spindle lift knob is included



max./min./TIR

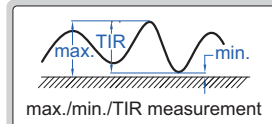

display direction is changeable

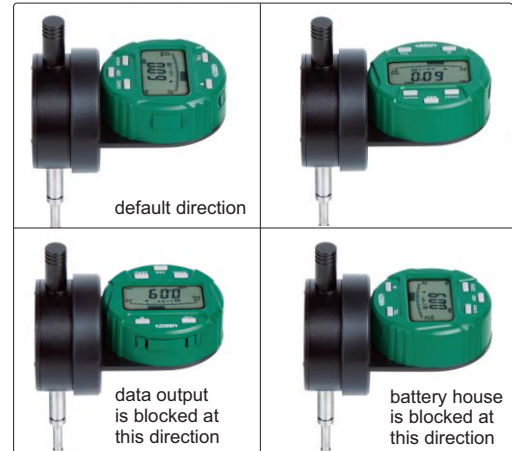

remark: to change above direction, 4 fixing screws on the back of display need to be removed first.

Code	Range	Resolution	Accuracy	Hysteresis	Maximum measuring force	Cap	Remark
2118-10 *	12.7mm/0.5"	0.01mm/0.0005"	20µm	10µm	1.5N	can lift	flat back
2118-101 *	12.7mm/0.5"	0.001mm/0.00005"	5µm	2µm	1.5N	can lift	flat back

*Supplied with manufacturer inspection certificate

ZEROING FOOT SWITCH

- For zeroing of digital indicators



7360-1M



Code	Description	Interface of digital indicators	Applicable products
7360-1M	zeroing foot switch with cable (length 2.5m)		for digital indicators

application

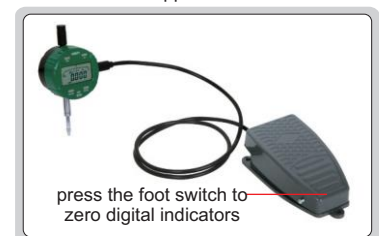

press the foot switch to zero digital indicators

DATA OUTPUT

LARGE STROKE DIGITAL INDICATORS

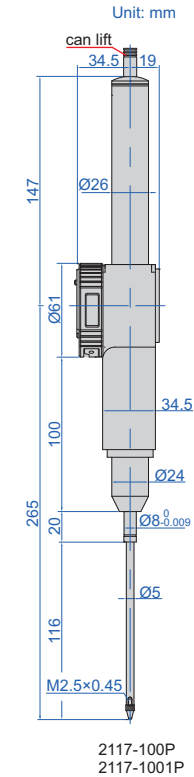
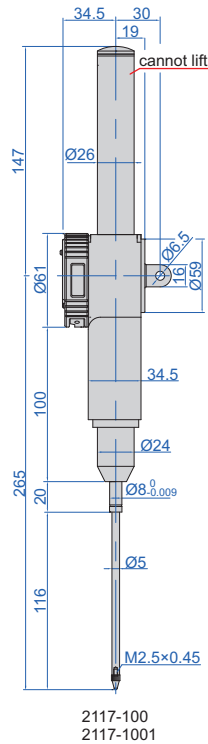

alarm when over tolerance



spindle lift knob is included



- Button function: on/off, zero, mm/inch, data preset, tolerance, change measuring direction, max./min./TIR measurement, absolute/incremental measurement
- Keep preset data and tolerance data in memory after restart
- CR2032 battery, automatic power off
- Data output
- Optional accessory:
 - wireless transmitter code **7315-50M** (receiver is needed) page 6,
 - bluetooth transmitter code **7214-50M** page 12,
 - data output cable code **7302-40M** page 21, **7305-40M** page 17,
 - backs (page 277-278), contact points (page 272-276)

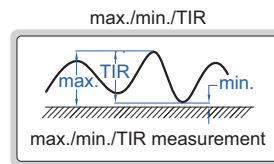

2117-100P/1001P



Resolution 0.01mm/0.0005"

Code	Range	Accuracy	Hysteresis	Maximum measuring force	Cap	Remark
2117-100	100mm/4"	30µm	10µm	3.2N	cannot lift	lug back
2117-100P	100mm/4"	30µm	10µm	3.2N	can lift	flat back

Resolution 0.001mm/0.00005"

Code	Range	Accuracy	Hysteresis	Maximum measuring force	Cap	Remark
2117-1001	100mm/4"	9µm	3µm	3.2N	cannot lift	lug back
2117-1001P	100mm/4"	9µm	3µm	3.2N	can lift	flat back

WIRELESS HIGH PRECISION DIGITAL INDICATORS



ABSOLUTE ENCODER, THE ORIGINAL DATA REMAINS AFTER POWER OFF

ATTENTION: RECHARGEABLE BATTERY, FOR 24 HOURS CONTINUOUS WORKING

CONTINUOUS DATA COLLECTION CAN BE CUSTOMIZED (PRESS "DATA" BUTTON TO START CONTINUOUS COLLECTION, PRESS AGAIN TO STOP; COLLECTION FREQUENCY CAN BE CUSTOMIZED, THE FASTEST DATA COLLECTION IS 10PCS PER SECOND)

LINEAR BALL BEARINGS FOR TEN MILLION TIMES USE



alarm when over tolerance

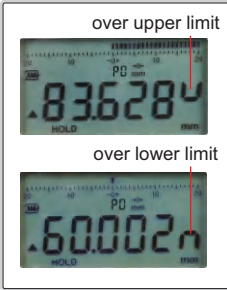

analog pointer

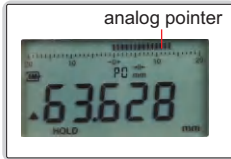

transmit data

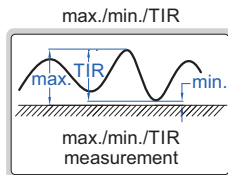
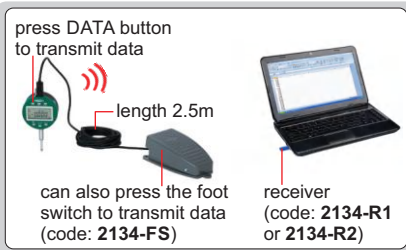

- Built-in wireless transmission, Zigbee single
- Linear ball bearings for ten million times use
- Absolute encoder, the original data remains after power off
- Reading in digital and analog
- Button function: data output, tolerance, data preset, data hold, measuring direction change, max./min./TIR, power off time, on/off, mm/inch, adjust resolution
- Power: rechargeable battery, for 24 hours continuous working
- Optional accessory: contact points (page 272~276), foot switch, code: **2134-FS** wireless receiver, code: **2134-R1** (keyboard format) **2134-R2** (serial port format)

Standard accuracy

Carbide probe
Adjustable resolution: 0.0005mm/0.00002"
0.001mm/0.00005"
0.01mm/0.0005"

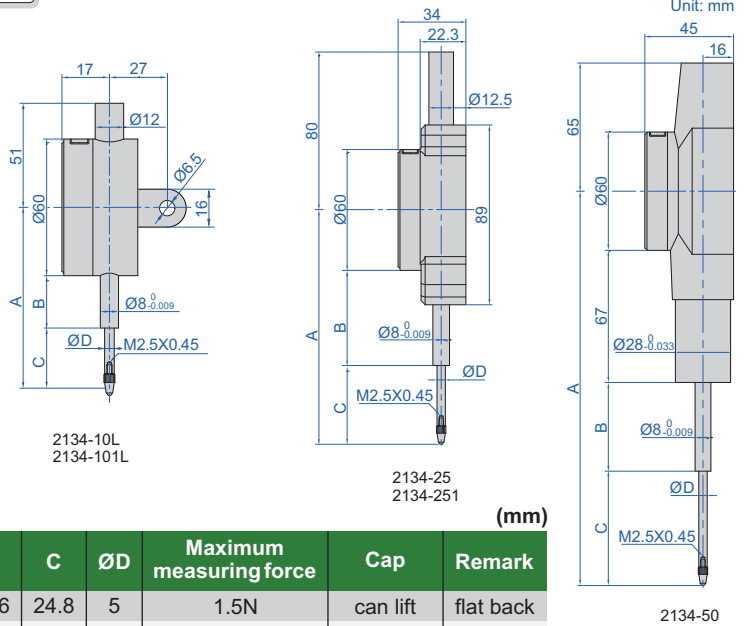

Code	Range	Accuracy	Hysteresis	A	B	C	ØD	Maximum measuring force	Cap	Remark
2134-10*	12.7mm/0.5"	3µm	1.5µm	75.4	20.6	24.8	5	1.5N	can lift	flat back
2134-10L*	12.7mm/0.5"	3µm	1.5µm	75.4	20.6	24.8	5	1.5N	can lift	lug back
2134-25*	25.4mm/1"	3µm	1.5µm	109.5	38.5	41	5	2.2N	cannot lift	flat back
2134-50*	50.8mm/2"	3µm	1.5µm	201	32	72	4.5	2.5N	—	flat back

High accuracy

Ruby probe
Adjustable resolution: 0.0002mm/0.00001"
0.001mm/0.00005"
0.01mm/0.0005"

Code	Range	Accuracy	Hysteresis	A	B	C	ØD	Maximum measuring force	Cap	Remark
2134-101*	12.7mm/0.5"	1.5µm	1µm	77.4	26	21.4	4	1.5N	can lift	flat back
2134-101L*	12.7mm/0.5"	1.5µm	1µm	77.4	26	21.4	4	1.5N	can lift	lug back
2134-251*	25.4mm/1"	1.8µm	1µm	116.1	42.5	44	4	2.2N	cannot lift	flat back

*Supplied with manufacturer inspection certificate

spindle lift knob is included



LINEAR BALL BEARINGS FOR TEN MILLION TIMES USE

ABSOLUTE ENCODER, THE ORIGINAL DATA REMAINS AFTER POWER OFF

DATA OUTPUT

ATTENTION: RECHARGEABLE BATTERY, FOR 24 HOURS CONTINUOUS WORKING

HIGH PRECISION DIGITAL INDICATORS

INSPECTION CERTIFICATE

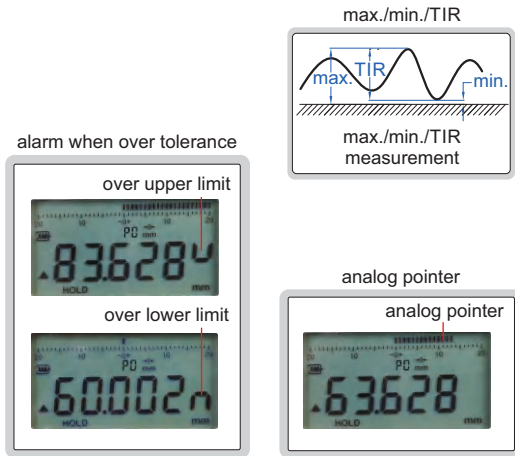

- Linear ball bearings for ten million times use
- Absolute encoder, the original data remains after power off
- Reading in digital and analog
- Data output
- Button function: data output, tolerance, data preset, data hold, measuring direction change, max./min./TIR, power off time, on/off, mm/inch, adjust resolution
- Power: rechargeable battery, for 24 hours continuous working
- Optional accessory: contact points (page 272-276), wireless transmitter code **7315-60** (receiver is needed) page 7, data output cable (keyboard format) code **7302-60** page 21, data output cable (serial port format) code **7305-G60** page 19 (cable length 3m, optional cable length maximum 15m; RS232 protocol, optional RS485 protocol)

Standard accuracy

Carbide probe
Adjustable resolution: 0.0005mm/0.00002"
0.001mm/0.00005"
0.01mm/0.0005"

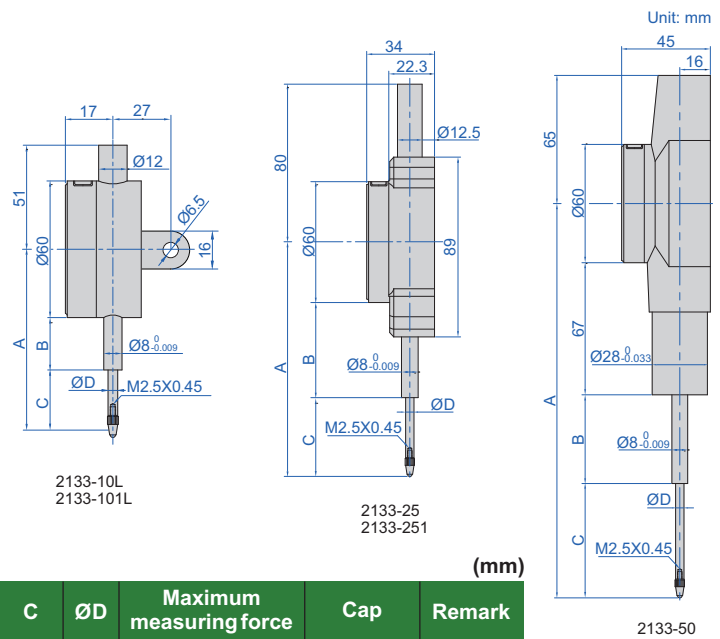

Code	Range	Accuracy	Hysteresis	A	B	C	ØD	Maximum measuring force	Cap	Remark
2133-10*	12.7mm/0.5"	3µm	1.5µm	75.4	20.6	24.8	5	1.5N	can lift	flat back
2133-10L*	12.7mm/0.5"	3µm	1.5µm	75.4	20.6	24.8	5	1.5N	can lift	lug back
2133-25*	25.4mm/1"	3µm	1.5µm	109.5	38.5	41	5	2.2N	cannot lift	flat back
2133-50*	50.8mm/2"	3µm	1.5µm	201	32	72	4.5	2.5N	—	flat back

High accuracy

Ruby probe
Adjustable resolution: 0.0002mm/0.00001"
0.001mm/0.00005"
0.01mm/0.0005"

Code	Range	Accuracy	Hysteresis	A	B	C	ØD	Maximum measuring force	Cap	Remark
2133-101*	12.7mm/0.5"	1.5µm	1µm	77.4	26	21.4	4	1.5N	can lift	flat back
2133-101L*	12.7mm/0.5"	1.5µm	1µm	77.4	26	21.4	4	1.5N	can lift	lug back
2133-251*	25.4mm/1"	1.8µm	1µm	116.1	42.5	44	4	2.2N	cannot lift	flat back

spindle lift knob is included



* Supplied with manufacturer inspection certificate

HIGH PRECISION DIGITAL INDICATORS

ATTENTION: RECHARGEABLE BATTERY, FOR 30 HOURS CONTINUOUS WORKING

IP54 WATERPROOF



ABSOLUTE ENCODER, THE ORIGINAL DATA REMAINS AFTER POWER OFF

Unit: mm



2136-10

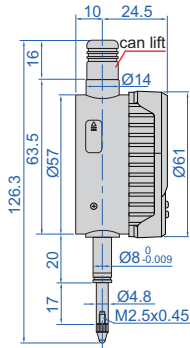

2136-25

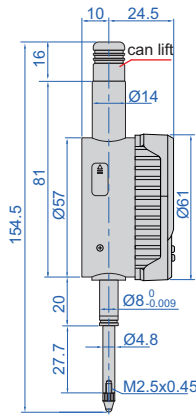

2136-50

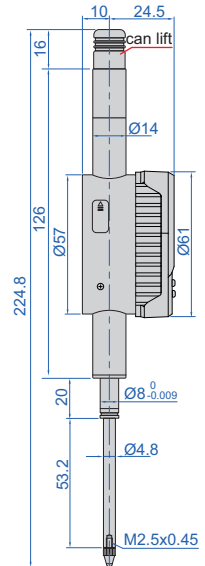

10

- IP54 dust/waterproof (when cap is lifted, no dust/waterproof)
- Absolute encoder, the original data remains after power off
- Automatic power off
- Reading in digital and analog
- Display can be rotated by 270°
- Button function: on/off, zero setting, data preset, tolerance Go and No-Go display, data hold, mm/inch, measuring direction change, max./min./TIR, absolute/incremental measurement, data output
- Data output with USB cable (keyboard format), cable length 1.8 meters, single and continuous transmission (the fastest data output is 40pcs per 10s)
- Power: rechargeable battery, for 30 hours continuous working

analog pointer



alarm when over tolerance

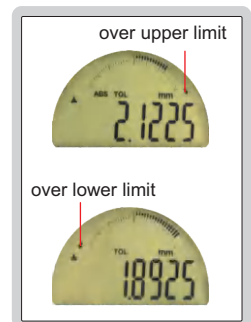

spindle lift knob is included



max./min./TIR

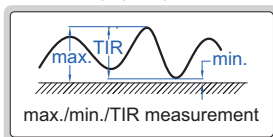

display can be rotated (counterclockwise 270°)



Resolution 0.0005mm/0.00002"

Code	Range	Accuracy	Hysteresis	Maximum measuring force	Cap	Remark
2136-10 *	0-12.7mm/0-0.5"	2µm	1.5µm	1.5N	can lift	flat back
2136-25 *	0-25.4mm/0-1"	2µm	1.5µm	1.8N	can lift	flat back
2136-50 *	0-50.8mm/0-2"	4µm	2µm	2.3N	can lift	flat back

* Supplied with manufacturer inspection certificate

ATTENTION: RECHARGEABLE BATTERY,
FOR 30 HOURS CONTINUOUS WORKING

BLUETOOTH HIGH PRECISION DIGITAL INDICATORS

BUILT-IN
BLUETOOTH

IP54
WATERPROOF

COLOR DISPLAY
LARGE CHARACTERS WITH BACKLIGHT

ABSOLUTE ENCODER, THE ORIGINAL
DATA REMAINS AFTER POWER OFF

INSPECTION
CERTIFICATE



2135-10

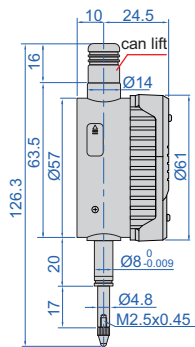

2135-25

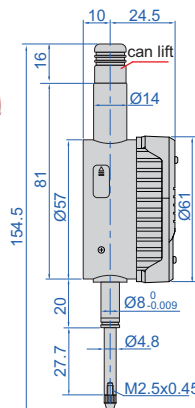

2135-50

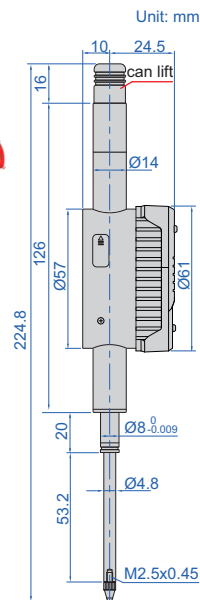

Unit: mm

- IP54 dust/waterproof (when cap is lifted, no dust/waterproof)
- Color display, large characters with backlight
- Absolute encoder, the original data remains after power off
- Automatic power off
- Display can be rotated by 270°
- Adjustable resolution: 0.0005mm/0.00002"
0.001mm/0.00005"
- Button function: on/off, zero setting, data preset, tolerance Go and No-Go display, data hold, mm/inch, measuring direction change, blue tooth, max./min./TIR, adjust resolution, absolute/incremental measurement, data output
- Android and iPhone APP, USB type-C cable are included
- Power: rechargeable Li-battery, for 30 hours continuous working (bluetooth transmission reduces working hours)

warning in red when over tolerance

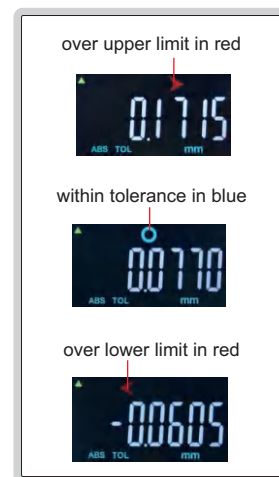

spindle lift knob is included



max./min./TIR

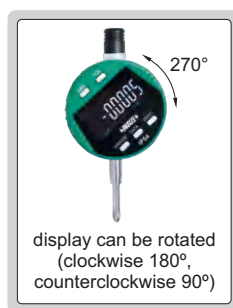
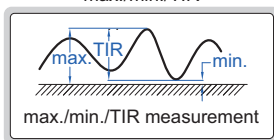

Code	Range	Accuracy	Hysteresis	Maximum measuring force	Cap	Remark
2135-10 *	12.7mm/0.5"	2µm	1.5µm	1.5N	can lift	flat back
2135-25 *	25.4mm/1"	2µm	1.5µm	1.8N	can lift	flat back
2135-50 *	50.8mm/2"	4µm	2µm	2.3N	can lift	flat back

* Supplied with manufacturer inspection certificate

To be continued

Continued from previous page

Data output

Data output with bluetooth (transmission distance is 10 meters)	keyboard format	data can be transmitted to Excel, Word, txt, etc.	single or continuous transmission (the fastest data output is 15pcs per 10s)
	virtual com port	data can be transmitted to Android and iPhone APP	real-time display (continuous transmission) or single transmission
Data output with USB cable (cable length 1.8 meters)	keyboard format	data can be transmitted to Excel, Word, txt, etc.	single or continuous transmission (the fastest data output is 40pcs per 10s)
	virtual com port and 485 data output can be customized		

data output with bluetooth and USB cable (included)

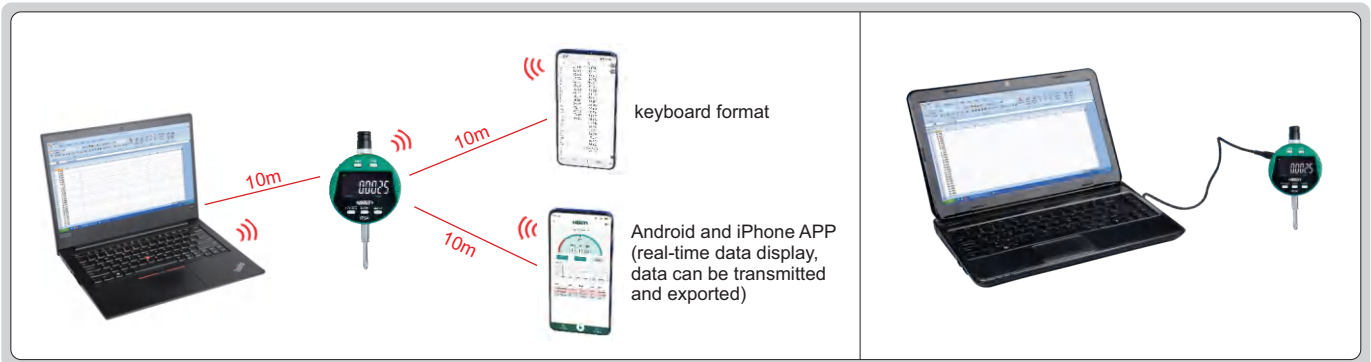

Android and iPhone APP (included), can choose real-time display (continuous transmission) or single transmission

Real-time data from multiple digital indicators (up to 7pcs simultaneously connected)

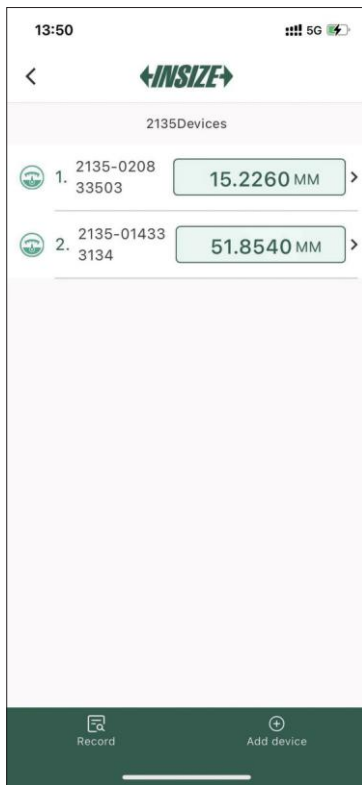

Transmission interface of single digital indicator

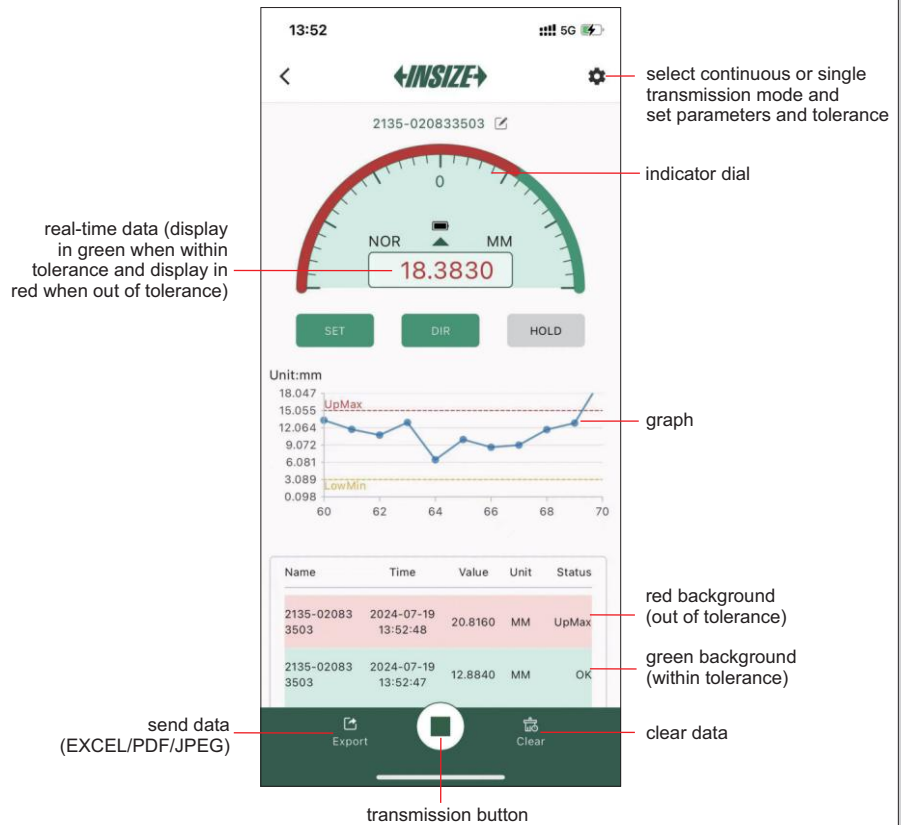

HIGH PRECISION DIGITAL INDICATORS



DATA OUTPUT

Ø28MM STEM SUITABLE FOR REINFORCED CLAMPING

ABSOLUTE ENCODER, THE ORIGINAL DATA REMAINS AFTER POWER OFF

LINEAR BALL BEARINGS FOR TEN MILLION TIMES USE

ATTENTION: RECHARGEABLE BATTERY, FOR 24 HOURS CONTINUOUS WORKING



2140-6

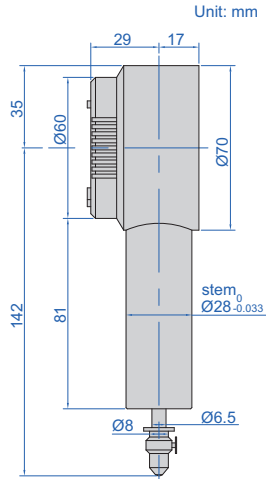

- Linear ball bearings for ten million times use
- Ø28mm stem suitable for reinforced clamping
- Absolute encoder, the original data remains after power off
- Adjustable resolution: 0.0002mm/0.00001"
0.001mm/0.00005"
0.01mm/0.0005"
- Reading in digital and analog
- Button function: data output, tolerance, data preset, data hold, measuring direction change, max./min./TIR, power off time, on/off, mm/inch, adjust resolution
- Power: rechargeable battery, for 24 hours continuous working
- Ruby probe

With data interface

Optional accessory:
wireless transmitter code **7315-60** (receiver is needed) page 7
data output cable (keyboard format) code **7302-60** page 21
data output cable (serial port format) code **7305-G60** page 19
(cable length 3m, optional cable length maximum 15m; RS232 protocol, optional RS485 protocol)

Code	Range	Accuracy	Hysteresis	Maximum measuring force	Remark
2140-6	0-6mm/0-0.24"	1.6µm	0.8µm	1.5N	flat back

Built-in wireless

Optional accessory:
wireless receiver (keyboard format, connect up to 15 digital indicators), code **2134-R1**
wireless receiver (serial port format, connect up to 15 digital indicators), code **2134-R2**

Code	Range	Accuracy	Hysteresis	Maximum measuring force	Remark
2140-6WL*	0-6mm/0-0.24"	1.6µm	0.8µm	1.5N	flat back

* Continuous data collection can be customized (press "DATA" button to start continuous collection, press again to stop; collection frequency can be customized, the fastest data collection is 10 pcs per second)

alarm when over tolerance

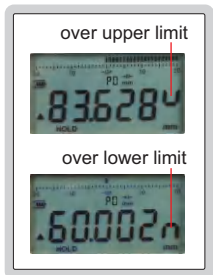

analog pointer

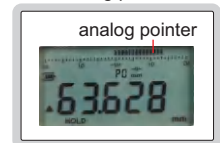

max./min./TIR

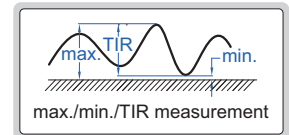

wireless receiver
2134-R1, 2134-R2 (optional)



SMART HIGH PRECISION DIGITAL INDICATORS

THE MEASURING TIME PERIOD CAN BE SET (1-99S IS ADJUSTABLE), THE MAX./MIN./TIR/AVG. CAN BE MEASURED AUTOMATICALLY DURING THIS PERIOD, AND THE DATA CAN BE TRANSMITTED AUTOMATICALLY AFTER EACH MEASUREMENT

ATTENTION: RECHARGEABLE BATTERY, FOR 24 HOURS CONTINUOUS WORKING

DATA OUTPUT



PRESS BUTTON OR PROBE MOVEMENT CAN START AUTOMATIC MEASUREMENT, THE MEASUREMENT CAN BE DELAYED (1-99S IS ADJUSTABLE)

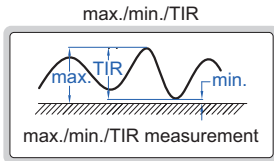

- Linear ball bearings for ten million times use
- Ø28mm stem suitable for reinforced clamping
- Absolute encoder, the original data remains after power off
- Adjustable resolution: 0.0001mm/0.00001"
0.001mm/0.00005"
0.01mm/0.0005"
- Reading in digital and analog
- Button function: on/off, adjust resolution, data hold, data output, max./min./TIR/avg., data preset, tolerance, mm/inch, automatic power off, measuring direction change, delay setting, measuring time setting
- Power: rechargeable Li-battery, for 24 hours continuous working
- Ruby probe



2150-5A

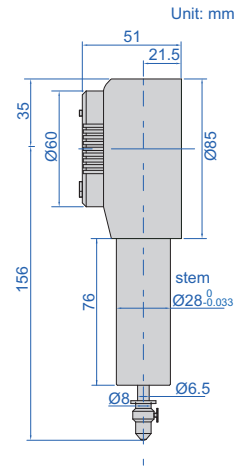

Unit: mm

10

alarm when over tolerance

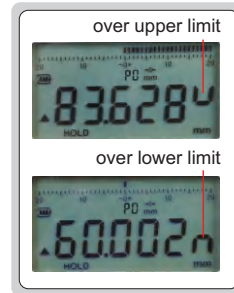

analog pointer

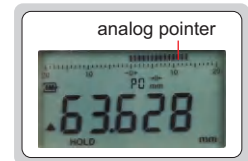

wireless receiver 2134-R1, 2134-R2 (optional)



With data interface

Optional accessory:
wireless transmitter code **7315-60** (receiver is needed) page 7
data output cable (keyboard format) code **7302-60** page 21
data output cable (serial port format) code **7305-G60** page 19
(cable length 3m, optional cable length maximum 15m; RS232 protocol, optional RS485 protocol)

Code	Range	Accuracy	Hysteresis	Maximum measuring force	Remark
2150-5A	0-5mm/0-0.2"	0.5µm	0.3µm	1.5N	probe movement starts measurement
2150-5B	0-5mm/0-0.2"	0.5µm	0.3µm	1.5N	press button starts measurement

Built-in wireless

Optional accessory:
wireless receiver (keyboard format, connect up to 15 digital indicators), code **2134-R1**
wireless receiver (serial port format, connect up to 15 digital indicators), code **2134-R2**

Code	Range	Accuracy	Hysteresis	Maximum measuring force	Remark
2150-5AWL *	0-5mm/0-0.2"	0.5µm	0.3µm	1.5N	probe movement starts measurement
2150-5BWL *	0-5mm/0-0.2"	0.5µm	0.3µm	1.5N	press button starts measurement

* Continuous data collection can be customized (press "DATA" button to start continuous collection, press it again to stop; collection frequency can be customized, the fastest data collection is 10pcs per second)

ATTENTION: RECHARGEABLE BATTERY,
FOR 12 HOURS CONTINUOUS WORKING

INDUCTIVE DIGITAL COMPARATOR (HIGH ACCURACY)



IP54
WATERPROOF

DATA
OUTPUT

data interface
(with protective cover)



touch sensor
to transmit data
signal light



2149-2

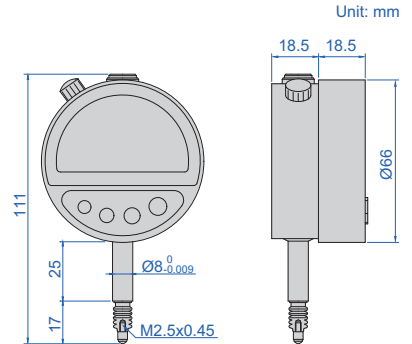

- Built-in wireless transmission
- IP54 dust/waterproof
- Reading in digital and analog
- Display can be rotated by 320°
- Can store 10 set parameters, and the parameter can be searched and recalled
- 999 groups value can be stored
- Touch sensor: use the sensor to transmit data, avoiding press the button to cause deformation of the dial indicator stand and affect the zero position
- Button function: on/off, zero, data hold, measuring direction change, inch/metric conversion, data preset, absolute/incremental measurement, max./min./TIR measurement, tolerance Go and No-Go display, data output, analog pointer resolution and range change, print data
- Power: rechargeable battery, for 12 hours continuous working
- Ruby probe
- Data output
- Optional accessory:
wireless receiver (code **2149-RE**, transmission distance is 2 meters),
printer (code **ISF-DF-PRINTER**)

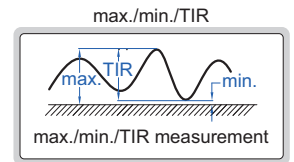

printer (optional)



wireless receiver (optional)



10

Code	Range	Resolution	Accuracy	Hysteresis	Repeatability	Measuring force
2149-2	2mm/0.08"	0.1µm/0.000005"	0.5µm	0.2µm	0.3µm	0.8-1N

PRECISION DIAL INDICATORS

JEWELLED
BEARING

INSPECTION
CERTIFICATE

- Graduation: 0.001mm
- Jeweled bearing
- Supplied with limit pointers and bezel clamp
- Optional accessory: backs (page 277~278), contact points (page 272~276)



2313-1A

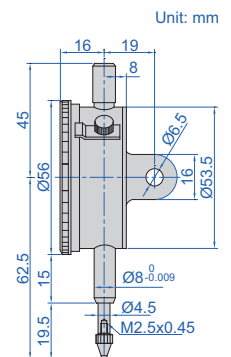

Code	Range	Accuracy	Hysteresis	Range/rev	Dial reading	Maximum measuring force	Cap	Remark
2313-1FA *	1mm	5µm	2µm	0.2mm	0-100-0	2N	cannot lift	flat back
2313-2FA *	2mm	6µm	2.5µm	0.2mm	0-100-0	2N	cannot lift	flat back
2313-1A *	1mm	5µm	2µm	0.2mm	0-100-0	2N	cannot lift	lug back
2313-2A *	2mm	6µm	2.5µm	0.2mm	0-100-0	2N	cannot lift	lug back

* Supplied with manufacturer inspection certificate

COMPACT DIAL INDICATORS

- Meet DIN878
- Graduation: 0.01mm
- Dial reading: 0-50
- Jeweled bearing
- Supplied with limit pointers and bezel clamp
- Optional accessory: backs (page 277~278), contact points (page 272~276)



2311-5

JEWELLED BEARING

INSPECTION CERTIFICATE

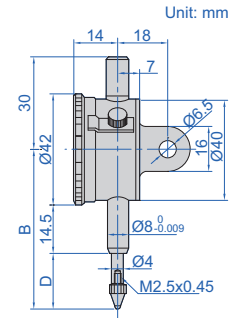

Code	Range	Accuracy	Hysteresis	Range/rev	Maximum measuring force	Cap	Remark	B	D
2311-3F *	3mm	12µm	3µm	0.5mm	1.5N	can lift	flat back	46	10.5
2311-5F *	5mm	14µm	3µm	0.5mm	1.5N	can lift	flat back	48	12.5
2311-3 *	3mm	12µm	3µm	0.5mm	1.5N	can lift	lug back	46	10.5
2311-5 *	5mm	14µm	3µm	0.5mm	1.5N	can lift	lug back	48	12.5

*Supplied with manufacturer inspection certificate

DIAL INDICATORS (STANDARD TYPE)

- Meet DIN878
- Jeweled bearing
- Supplied with limit pointers and bezel clamp
- Optional accessory: backs (page 277~278), contact points (page 272~276)



2308-10A

JEWELLED BEARING

INSPECTION CERTIFICATE

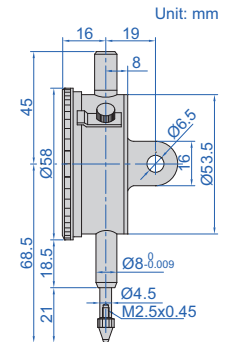

Code	Range	Graduation	Accuracy	Hysteresis	Range/rev	Dial reading	Maximum measuring force	Cap	Remark
2308-3FA *	3mm	0.01mm	12µm	3µm	1mm	0-100	1.5N	can lift	flat back
2308-5FA *	5mm	0.01mm	14µm	3µm	1mm	0-100	1.5N	can lift	flat back
2308-10FA *	10mm	0.01mm	17µm	3µm	1mm	0-100	1.5N	can lift	flat back
2308-3A *	3mm	0.01mm	12µm	3µm	1mm	0-100	1.5N	can lift	lug back
2308-5A *	5mm	0.01mm	14µm	3µm	1mm	0-100	1.5N	can lift	lug back
2308-10A *	10mm	0.01mm	17µm	3µm	1mm	0-100	1.5N	can lift	lug back

*Supplied with manufacturer inspection certificate

DIAL INDICATORS (BASIC TYPE)

- Meet DIN878
- Graduation: 0.01mm
- Jeweled bearing
- Supplied with limit hands and bezel clamp
- Packed in carton box
- Optional accessory: backs (page 277~278), contact points (page 272~276)



2301-10

JEWELLED BEARING

INSPECTION CERTIFICATE

POPULAR MODEL

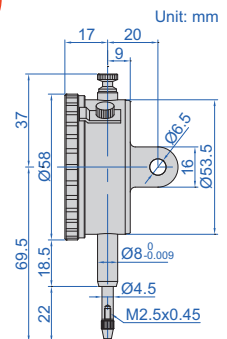

Code	Range	Accuracy	Hysteresis	Range/rev	Dial reading	Maximum measuring force	Cap	Remark
2301-10F *	10mm	17µm	3µm	1mm	0-100	1.5N	can lift	flat back
2301-10 *	10mm	17µm	3µm	1mm	0-100	1.5N	can lift	lug back with spare flat back

*Supplied with manufacturer inspection certificate



JEWELLED BEARING

REVERSE READING DIAL INDICATORS

- Meet DIN878
- Suitable for depth and step measurements
- Jeweled bearing
- Supplied with limit pointers and bezel clamp
- Optional accessory: backs (page 277~278), contact points (page 272~276)



2801-10

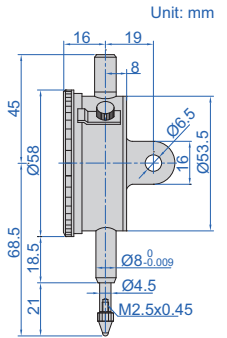

Code	Range	Graduation	Accuracy	Hysteresis	Range/rev	Dial reading	Maximum measuring force	Cap	Remark
2801-10F*	10mm	0.01mm	17µm	3µm	1mm	100-0	1.5N	can lift	flat back
2801-10*	10mm	0.01mm	17µm	3µm	1mm	100-0	1.5N	can lift	lug back

*Supplied with manufacturer inspection certificate



SHOCK PROOF

JEWELLED BEARING

SHOCKPROOF DIAL INDICATORS

- Meet DIN878
- Shockproof
- Jeweled bearing
- Supplied with limit pointers and bezel clamp
- Optional accessory: backs (page 277~278), contact points (page 272~276)



2314-10A

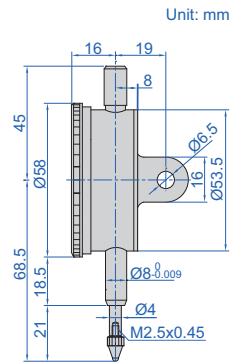

Code	Range	Graduation	Accuracy	Hysteresis	Range/rev	Dial reading	Maximum measuring force	Cap	Remark
2314-3FA*	3mm	0.01mm	12µm	3µm	1mm	0-100	1.5N	can lift	flat back
2314-5FA*	5mm	0.01mm	14µm	3µm	1mm	0-100	1.5N	can lift	flat back
2314-10FA*	10mm	0.01mm	17µm	3µm	1mm	0-100	1.5N	can lift	flat back
2314-3A*	3mm	0.01mm	12µm	3µm	1mm	0-100	1.5N	can lift	lug back
2314-5A*	5mm	0.01mm	14µm	3µm	1mm	0-100	1.5N	can lift	lug back
2314-10A*	10mm	0.01mm	17µm	3µm	1mm	0-100	1.5N	can lift	lug back

*Supplied with manufacturer inspection certificate



IP54 WATERPROOF

WATERPROOF DIAL INDICATORS

- Meet DIN878
- IP54 dust/waterproof
- With limit pointers
- Optional accessory: backs (page 277~278), contact points (page 272~276)



2324-10A

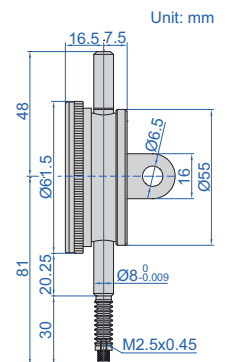

Code	Range	Graduation	Accuracy	Hysteresis	Range/rev	Dial reading	Maximum measuring force	Cap	Remark
2324-10FA*	10mm	0.01mm	17µm	3µm	1mm	0-100	1.5N	cannot lift	flat back
2324-10A*	10mm	0.01mm	17µm	3µm	1mm	0-100	1.5N	cannot lift	lug back

*Supplied with manufacturer inspection certificate

DIAL INDICATORS (LONG STROKE)

- Graduation: 0.01mm
- Dial reading: 0-100
- Supplied with limit pointers and bezel clamp
- Optional accessory: backs (page 277~278), contact points (page 272~276)



2310-30A

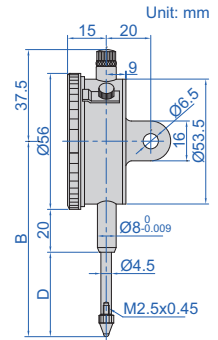

Code	Range	Accuracy	Hysteresis	Range/rev	Maximum measuring force	Cap	Remark	B	D
2310-20FA*	20mm	25µm	5µm	1mm	2.0N	can lift	flat back	83	35
2310-30FA*	30mm	35µm	7µm	1mm	2.2N	can lift	flat back	88	40
2310-20A*	20mm	25µm	5µm	1mm	2.0N	can lift	lug back	83	35
2310-30A*	30mm	35µm	7µm	1mm	2.2N	can lift	lug back	88	40

*Supplied with manufacturer inspection certificate

DIAL INDICATORS (LONG STROKE, BASIC TYPE)



- Supplied with limit pointers and bezel clamp
- Graduation: 0.01mm
- Packed in carton box
- Optional accessory: backs (page 277~278), contact points (page 272~276)



2302-25

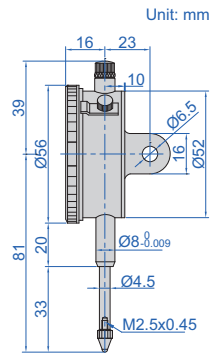

Code	Range	Accuracy	Hysteresis	Range/rev	Dial reading	Maximum measuring force	Cap	Remark
2302-25F*	25mm	35µm	7µm	1mm	0-100	2.2N	can lift	flat back
2302-25*	25mm	35µm	7µm	1mm	0-100	2.2N	can lift	lug back with spare flat back

*Supplied with manufacturer inspection certificate

DOUBLE FACE DIAL INDICATOR



- Meet DIN878
- Read from both sides
- Jeweled bearing
- Supplied with limit pointers
- Optional accessory: contact points (page 272~276)



front

2328-10

back

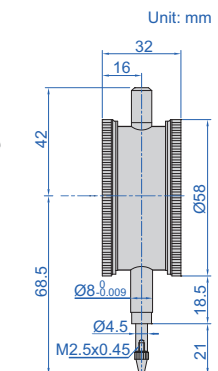

Code	Range	Graduation	Accuracy	Hysteresis	Range/rev	Dial reading	Maximum measuring force	Cap
2328-10*	10mm	0.01mm	17µm	3µm	1mm	0-100	1.5N	can lift

*Supplied with manufacturer inspection certificate

DIAL INDICATORS (GRADUATION 0.1mm)

- Graduation: 0.1mm
- Dial reading: 0-10
- Supplied with limit pointers and bezel clamp
- Optional accessory: backs (page 277~278), contact points (page 272~276)



2318-30

Code	Range	Accuracy	Hysteresis	Range/rev	Maximum measuring force	Cap	Remark	B	D
2318-10F	10mm	40µm	20µm	10mm	2.0N	can lift	flat back	70	20
2318-20F	20mm	50µm	20µm	10mm	2.0N	can lift	flat back	85	35
2318-25F	25mm	60µm	20µm	10mm	2.2N	can lift	flat back	85	35
2318-30F	30mm	60µm	20µm	10mm	2.2N	can lift	flat back	90	40
2318-10	10mm	40µm	20µm	10mm	2.0N	can lift	lug back	70	20
2318-20	20mm	50µm	20µm	10mm	2.0N	can lift	lug back	85	35
2318-25	25mm	60µm	20µm	10mm	2.2N	can lift	lug back	85	35
2318-30	30mm	60µm	20µm	10mm	2.2N	can lift	lug back	90	40

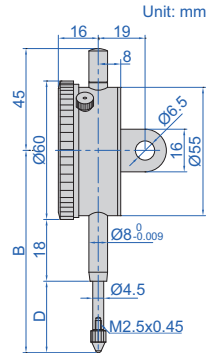

DIAL INDICATORS (LONG STROKE)

- Graduation: 0.01mm
- Dial reading: 0-100
- Shockproof
- Jeweled bearing
- Supplied with limit pointers
- Optional accessory: backs (page 277~278), contact points (page 272~276)



2309-50

INSPECTION CERTIFICATE

JEWELLED BEARING

SHOCK PROOF

10

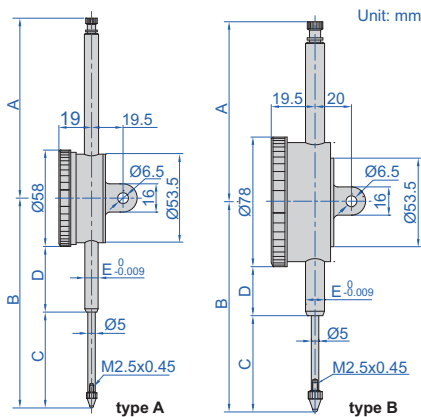

stem clamp Ø10mm for 2309-100D



back of type B



Code	Type	A	B	C	D	E
2309-30F	A	37.5	89.5	40.9	19.5	Ø8
2309-30	A	37.5	89.5	40.9	19.5	Ø8
2309-50	A	108.3	126.2	57.7	39.5	Ø8
2309-50D	B	108.3	126.2	57.7	29.5	Ø8
2309-80	A	138.4	168.4	88	51.3	Ø8
2309-80D	B	138.4	168.4	88	41.3	Ø8
2309-100D	B	167.6	207.8	108	60.8	Ø10

(mm)

Code	Range	Type	Accuracy	Hysteresis	Range/rev	Maximum measuring force	Cap	Remark
2309-30F*	30mm	A	35µm	7µm	1mm	2.2N	can lift	flat back
2309-30*	30mm	A	35µm	7µm	1mm	2.2N	can lift	lug back
2309-50*	50mm	A	40µm	8µm	1mm	2.5N	can lift	flat back with spare lug back
2309-50D*	50mm	B	40µm	8µm	1mm	2.5N	can lift	flat back with spare lug back
2309-80	80mm	A	50µm	9µm	1mm	3.2N	can lift	flat back with spare lug back
2309-80D	80mm	B	50µm	9µm	1mm	3.2N	can lift	flat back with spare lug back
2309-100D	100mm	B	50µm	9µm	1mm	3.2N	can lift	flat back with spare lug back

Note: 1) 2309-80, 2309-80D and 2309-100D can only be used vertically
 2) 2309-100D is supplied with stem clamp Ø10mm for magnetic stands (code 6200-60, 6201-60, 6202-80, 6202-100)
 3) 2309-30 and 2309-30F can not accept optional backs (page 277~278)

* Supplied with manufacturer inspection certificate

ONE REVOLUTION DIAL INDICATORS

SHOCK PROOF

INSPECTION CERTIFICATE

- Meet DIN878
- Graduation: 0.01mm
- Eliminate the possibility of reading errors due to miscounting
- Shockproof
- Supplied with limit pointers
- Optional accessory: backs (page 277~278), contact points (page 272~276)

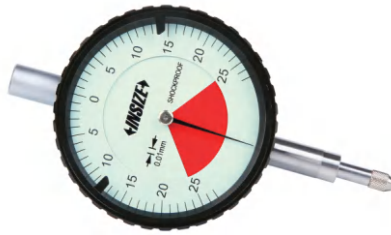

2316-05

Code	Range	Dial indicator stroke	Accuracy	Hysteresis	Dial reading	Maximum measuring force	Cap	Remark
2316-05F *	0.5mm	5mm	9µm	3µm	25-0-25	1.5N	cannot lift	flat back
2316-1F *	1mm	5mm	9µm	3µm	50-0-50	1.5N	cannot lift	flat back
2316-05 *	0.5mm	5mm	9µm	3µm	25-0-25	1.5N	cannot lift	lug back
2316-1 *	1mm	5mm	9µm	3µm	50-0-50	1.5N	cannot lift	lug back

*Supplied with manufacturer inspection certificate

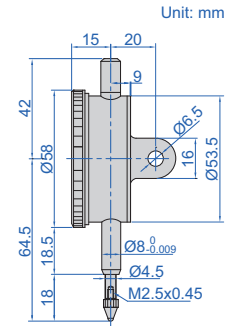

INCH DIAL INDICATORS

INSPECTION CERTIFICATE

- Meet ASME B89.1.10M-2001
- With lug back
- Supplied with limit pointers and bezel clamp
- Optional accessory: backs (page 277~278), contact points (page 272~276)



2307-1

Range	A	B	C	D
0.25"	1.811"	2.953"	0.787"	0.984"
0.5"	1.811"	2.953"	0.787"	0.984"
1"	1.811"	3.346"	0.787"	1.378"
2"	4.370"	5.472"	1.969"	2.323"

Code	Range	Graduation	Accuracy		Range/rev	Dial reading	Maximum measuring force	Cap
			First 2.5 rev	Overall				
2307-025 *	0.25"	0.001"	±0.001"	±0.001"	0.1"	0-100	1.8N	can lift
2307-05 *	0.5"	0.001"	±0.001"	±0.002"	0.1"	0-100	1.8N	can lift
2307-1 *	1"	0.001"	±0.001"	±0.002"	0.1"	0-100	1.8N	can lift
2307-2 *	2"	0.001"	±0.001"	±0.004"	0.1"	0-100	2.5N	cannot lift
2307-0255 *	0.25"	0.0005"	±0.0005"	±0.0015"	0.05"	0-50	1.8N	can lift
2307-055 *	0.5"	0.0005"	±0.0005"	±0.0015"	0.05"	0-50	1.8N	can lift
2307-105 *	1"	0.0005"	±0.0005"	±0.002"	0.05"	0-50	1.8N	can lift
2307-205 *	2"	0.0005"	±0.0005"	±0.002"	0.05"	0-50	2.5N	cannot lift

*Supplied with manufacturer inspection certificate

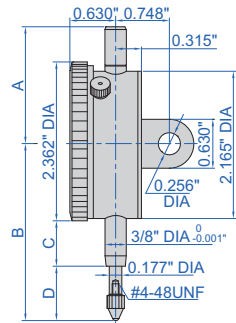

INCH LONG STROKE DIAL INDICATOR

INSPECTION CERTIFICATE

- Graduation 0.001"
- With lug back
- Supplied with limit pointers and bezel clamp
- Optional accessory: backs (page 277~278), contact points (page 272~276)



2326-2

Code	Range	Accuracy		Range/rev	Dial reading	Maximum measuring force	Cap
		first 2.5 rev	overall				
2326-2 *	2"	±0.001"	±0.004"	0.1"	0-100	2.5N	cannot lift

*Supplied with manufacturer inspection certificate

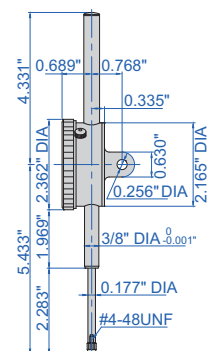

BALL POINTS



6282-0101

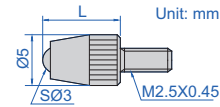

Code	Material of measuring face	L (mm)
6282-0101	carbide	7.3
6282-0103	ceramic	7.3
6282-0104	carbide	8.3
6282-0106	carbide	12.1
6282-0107	carbide	14
6282-0108	carbide	15
6282-0109	ceramic	15
6282-0110	carbide	17

Code	Material of measuring face	L (mm)
6282-0111	carbide	19.3
6282-0112	carbide	20
6282-0113	ceramic	20
6282-0114	carbide	22
6282-0115	carbide	25
6282-0116	ceramic	25
6282-0117	carbide	30
6282-0118	ceramic	30

Code	Material of measuring face	L (mm)
6282-0119	carbide	35
6282-0120	ruby	35
6282-0121	carbide	40
6282-0122	ruby	40
6282-0123	carbide	45
6282-0124	ruby	45
6282-0125	carbide	50
6282-0126	ruby	50



6282-0301

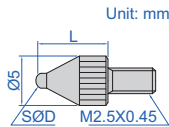

6282-0304

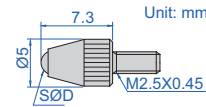

Code	Material of measuring face	SØD (mm)	L (mm)
6282-0301	steel	1	7.3
6282-0306	carbide	1	6
6282-0307	carbide	2	7
6282-0308	carbide	3	8
6282-0309	carbide	3.5	8.5
6282-0310	carbide	4	9
6282-0311	carbide	4.5	9.5
6282-0312	carbide	5.5	10
6282-0313	carbide	6	10.5
6282-0314	carbide	7	11.5

Code	Material of measuring face	SØD (mm)
6282-0302	carbide	1.5
6282-0303	carbide	1.8
6282-0304	carbide	2.5
6282-0305	carbide	4



6282-3407

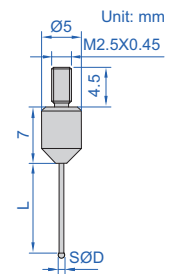

Code	Material of measuring face	L (mm)	SØD (mm)
6282-3401	ruby	10	1
6282-3402	ruby	20	1
6282-3403	ruby	30	1
6282-3404	ruby	40	1
6282-3405	ruby	50	1
6282-3406	ruby	10	2
6282-3407	ruby	20	2
6282-3408	ruby	30	2
6282-3409	ruby	40	2
6282-3410	ruby	50	2
6282-3411	carbide	10	1
6282-3412	carbide	20	1

Code	Material of measuring face	L (mm)	SØD (mm)
6282-3413	carbide	30	1
6282-3414	carbide	40	1
6282-3415	carbide	50	1
6282-3416	carbide	10	1.5
6282-3417	carbide	20	1.5
6282-3418	carbide	30	1.5
6282-3419	carbide	40	1.5
6282-3420	carbide	50	1.5
6282-3421	carbide	10	2
6282-3422	carbide	20	2
6282-3423	carbide	30	2
6282-3424	carbide	40	2

Code	Material of measuring face	L (mm)	SØD (mm)
6282-3425	carbide	50	2
6282-3426	carbide	10	2.5
6282-3427	carbide	20	2.5
6282-3428	carbide	30	2.5
6282-3429	carbide	40	2.5
6282-3430	carbide	50	2.5
6282-3431	carbide	10	3
6282-3432	carbide	20	3
6282-3433	carbide	30	3
6282-3434	carbide	40	3
6282-3435	carbide	50	3

SHELL TYPE POINTS

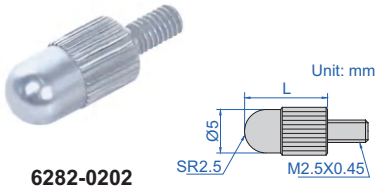

6282-0202

Code	Material of measuring face	L (mm)
6282-0202	steel	5
6282-0203	steel	10
6282-0205	steel	15

Code	Material of measuring face	L (mm)
6282-0207	steel	20
6282-0208	steel	25
6282-0210	steel	30

SPHERICAL POINT

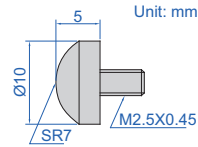

6282-0401

Code	Material of measuring face
6282-0401	steel

CONICAL POINTS

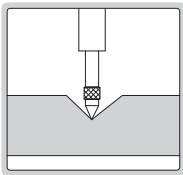

10



6282-0601



6282-0701



6282-0801



6282-0901

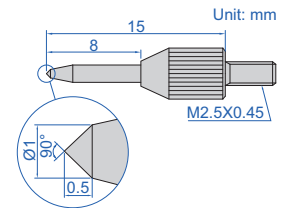
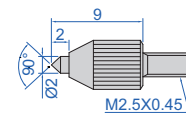
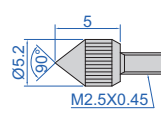
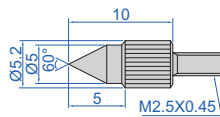

Code	Material of measuring face
6282-0601	steel
6282-0701	steel
6282-0801	steel
6282-0901	steel

FLAT POINTS



6282-1101

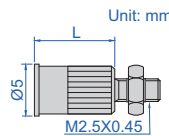

Code	Material of measuring face	L (mm)
6282-1101	steel	8
6282-1102	steel	10



6282-1301

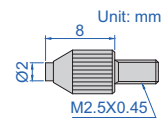

Code	Material of measuring face
6282-1301	carbide



6282-1201

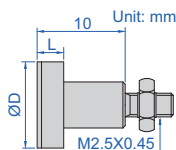

Code	Material of measuring face	ØD	L
6282-1201	steel	10mm	3mm
6282-1202	steel	15mm	4mm
6282-1203	steel	20mm	3mm
6282-1204	steel	25mm	4mm
6282-1205	steel	30mm	3mm

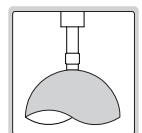

FLAT POINTS



6282-2902

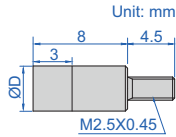

6282-3004

Code	Material of measuring face	ØD (mm)
6282-2901	carbide	4
6282-2902	carbide	5
6282-2903	carbide	6
6282-2904	carbide	8
6282-2905	carbide	10

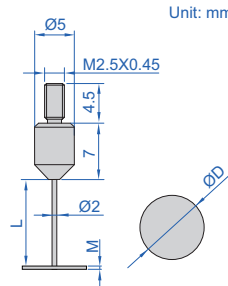

Code	Material of measuring face	L (mm)	M (mm)	ØD (mm)
6282-3001	carbide	13	0.4	3
6282-3002	carbide	13	0.4	4
6282-3003	carbide	13	0.4	5
6282-3004	carbide	13	0.4	6
6282-3005	carbide	13	1	6
6282-3006	carbide	33	0.4	6
6282-3007	carbide	13	0.4	8
6282-3008	carbide	13	0.4	10

NEEDLE POINTS



6282-1711

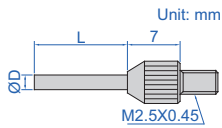

Code	Material of measuring face	ØD (mm)	L (mm)
6282-1701	steel	0.45	3
6282-1702	steel	0.45	5
6282-1703	carbide	1	3
6282-1704	carbide	1	5
6282-1705	carbide	1	8
6282-1706	carbide	1	10
6282-1707	carbide	1	20
6282-1708	carbide	1	40
6282-1709	carbide	1.5	5
6282-1710	carbide	1.5	10
6282-1711	carbide	1.5	13
6282-1712	carbide	1.5	20
6282-1713	carbide	1.5	40
6282-1714	carbide	2	8
6282-1715	carbide	2	18
6282-1716	carbide	2	28
6282-1717	carbide	2	40

Code	Material of measuring face	ØD (mm)	L (mm)
6282-1718	carbide	1	50
6282-1719	carbide	1.5	50
6282-1720	carbide	2	50
6282-1721	ceramic	1	10
6282-1722	ceramic	1	20
6282-1723	ceramic	1.5	10
6282-1724	ceramic	1.5	20
6282-1725	ceramic	1.5	30
6282-1726	ceramic	1.5	40
6282-1727	ceramic	1.5	50
6282-1728	ceramic	2	10
6282-1729	ceramic	2	20
6282-1730	ceramic	2	30
6282-1731	ceramic	2	40
6282-1732	ceramic	2	50



6282-3303

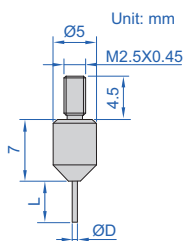

Code	Material of measuring face	ØD (mm)	L (mm)
6282-3301	carbide	0.5	3
6282-3302	carbide	0.5	5
6282-3303	carbide	0.5	10
6282-3304	carbide	0.6	10
6282-3305	carbide	0.7	10
6282-3306	carbide	0.8	10
6282-3307	carbide	0.9	10
6282-3308	carbide	1.2	10
6282-3309	carbide	0.5	15
6282-3310	carbide	0.6	15

Code	Material of measuring face	ØD (mm)	L (mm)
6282-3311	carbide	0.7	15
6282-3312	carbide	0.8	15
6282-3313	carbide	0.9	15
6282-3314	carbide	1.2	15
6282-3315	carbide	0.5	20
6282-3316	carbide	0.6	20
6282-3317	carbide	0.7	20
6282-3318	carbide	0.8	20
6282-3319	carbide	0.9	20
6282-3320	carbide	1.2	20

NEEDLE POINTS



6282-1601

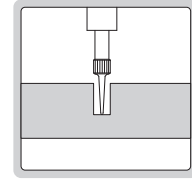
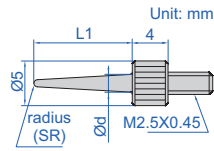

(mm)

Code	Material of measuring face	L1	Ød	SR
6282-1611	steel	7	2	0.15
6282-1612	steel	13	2	0.15
6282-1613	steel	22	2	0.15
6282-1614	steel	30	2	0.15
6282-1615	steel	40	2	0.15
6282-1602	steel	13	2	0.2
6282-1616	steel	50	2	0.2
6282-1617	steel	13	2	0.3
6282-1618	steel	17	2	0.3
6282-1619	steel	22	2	0.3
6282-1620	steel	30	2	0.3
6282-1621	steel	40	2	0.3
6282-1601	steel	11	2	0.4
6282-1603	steel	21	3	0.4
6282-1604	steel	31	3	0.4
6282-1622	steel	50	2	0.4

(mm)

Code	Material of measuring face	L1	Ød	SR
6282-1623	carbide	13	2	0.2
6282-1624	carbide	23	2	0.2
6282-1625	carbide	30	2	0.2
6282-1626	carbide	40	2	0.2
6282-1627	carbide	50	2	0.2
6282-1628	carbide	13	2	0.35
6282-1629	carbide	23	2	0.35
6282-1630	carbide	30	2	0.35
6282-1631	carbide	40	2	0.35
6282-1632	carbide	50	2	0.35

10

KNIFE EDGE POINT



6282-1001

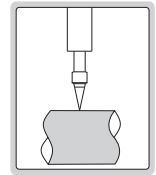
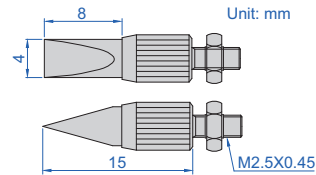

Code	Material of measuring face
6282-1001	steel

BLADE POINTS



6282-1801

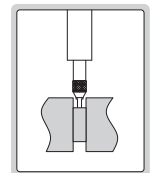
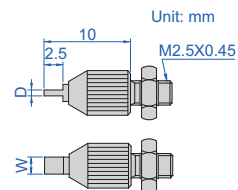

Code	Material of measuring face	D	W
6282-1801	steel	0.4mm	2mm
6282-1802	steel	0.6mm	2mm
6282-1803	steel	1mm	4mm

ROLLER POINT

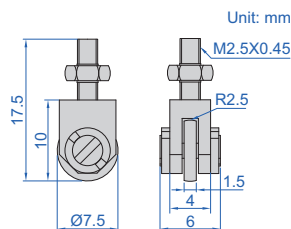

6282-1901

Code	Material of measuring face
6282-1901	steel

EXTENSION RODS

				(mm)			
Code	Material	L	Ød	Code	Material	L	Ød
6282-2001	steel	10	4	6282-2010	steel	55	4
6282-2002	steel	15	4	6282-2011	steel	60	4
6282-2003	steel	20	4	6282-2012	steel	65	4
6282-2004	steel	25	4	6282-2013	steel	70	4
6282-2005	steel	30	4	6282-2014	steel	75	4
6282-2006	steel	35	4	6282-2015	steel	80	4
6282-2007	steel	40	4	6282-2016	steel	90	4
6282-2008	steel	45	4	6282-2017	steel	100	4
6282-2009	steel	50	4	6282-2023	steel	150	5
				6282-2024	steel	200	5
				6282-2025	steel	300	5



POINT SET



6282-S6

Code	Material of measuring face
6282-S6	steel

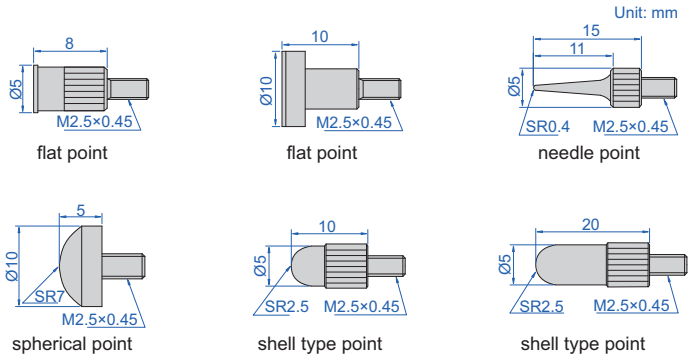

PRECISION BALL POINTS

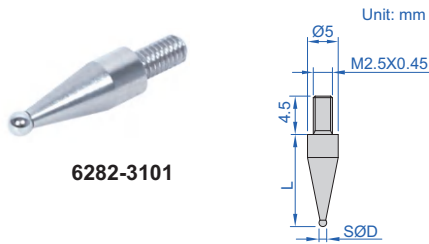

6282-3101

- Material of measuring face: carbide
- Accuracy: $\pm 2\mu\text{m}$

			(mm)						(mm)						(mm)		
Code	SØD	L	Code	SØD	L	Code	SØD	L	Code	SØD	L	Code	SØD	L	Code	SØD	L
6282-3101	1	12	6282-3113	1	20	6282-3125	1	30									
6282-3102	1.5	12	6282-3114	1.5	20	6282-3126	1.5	30									
6282-3103	2	12	6282-3115	2	20	6282-3127	2	30									
6282-3104	2.5	12	6282-3116	2.5	20	6282-3128	2.5	30									
6282-3105	3	12	6282-3117	3	20	6282-3129	3	30									
6282-3106	3.5	12	6282-3118	3.5	20	6282-3130	3.5	30									
6282-3107	4	12	6282-3119	4	20	6282-3131	4	30									
6282-3108	4.5	12	6282-3120	4.5	20	6282-3132	4.5	30									
6282-3109	5	12	6282-3121	5	20	6282-3133	5	30									
6282-3110	5.5	12	6282-3122	5.5	20	6282-3134	5.5	30									
6282-3111	6	12	6282-3123	6	20	6282-3135	6	30									
6282-3112	6.5	12	6282-3124	6.5	20	6282-3136	6.5	30									

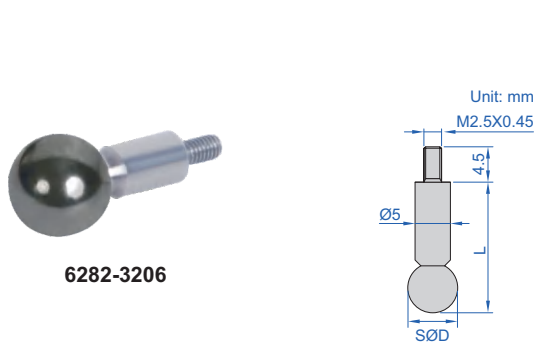

6282-3206

- Material of measuring face: carbide
- Accuracy: $\pm 2\mu\text{m}$

			(mm)						(mm)		
Code	SØD	L	Code	SØD	L	Code	SØD	L	Code	SØD	L
6282-3201	7	20	6282-3213	7	30						
6282-3202	7.5	20	6282-3214	7.5	30						
6282-3203	8	20	6282-3215	8	30						
6282-3204	8.5	20	6282-3216	8.5	30						
6282-3205	9	20	6282-3217	9	30						
6282-3206	9.5	20	6282-3218	9.5	30						
6282-3207	10	20	6282-3219	10	30						
6282-3208	10.5	20	6282-3220	10.5	30						
6282-3209	11	20	6282-3221	11	30						
6282-3210	12	20	6282-3222	12	30						
6282-3211	13	20	6282-3223	13	30						
6282-3212	14	20	6282-3224	14	30						

SPINDLE LIFT KNOB

■ For dial/digital indicators with spindle diameter $\varnothing 4.5\text{mm}$ or $\varnothing 5\text{mm}$



7332

Code

7332

SHAFT SLEEVE

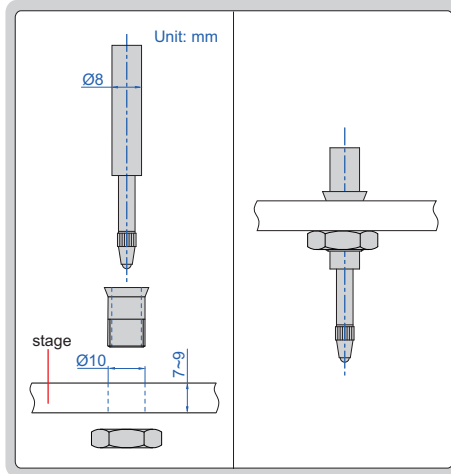

7333

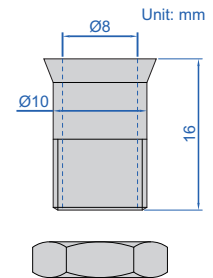

10

■ For dial indicators and probes with shaft diameter $\varnothing 8\text{mm}$

Code

7333

MAGNETIC BACKS

Code	ØD	For digital/dial indicators
7331-M1	51.5mm	2103
		2104
		2108
		2109
		2112
		2115
		2116
		2117
		2118
		2137
		2138
		2139
		2501
		2301
		2302
		2308
		2309 (except 2309-30, 2309-30F)
		2313
		2314
		2316
2324		
2801		
7331-M2	54mm	2318



front

back

7331-M2

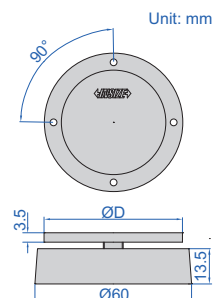

FLAT BACKS

Code	For digital/ dial indicators
7330-F1	2311
7330-F2	2301
	2302
	2308
	2309 (except 2309-30, 2309-30F)
	2313
	2314
	2316
7330-F5	2324
	2801
	2103
	2104
	2108
	2109
	2112
	2115
	2116
	2117
	2118
	2138
	2139
2501	
2137	



7330-F2



7330-F8

Code	For digital/ dial indicators
7330-F6	2318
7330-F10	2307
	2326
7330-F10	2310

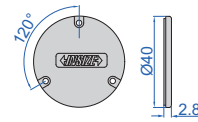

7330-F1

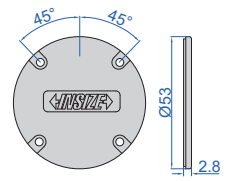

7330-F2 and 7330-F10

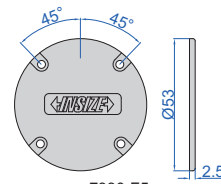

7330-F5

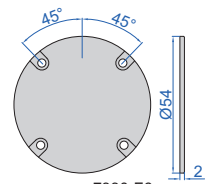

7330-F6

Unit: mm

LUG BACKS

Code	For digital/ dial indicators
7330-L1	2311
7330-L2	2301
	2302
	2308
	2309 (except 2309-30, 2309-30F)
	2313
	2314
	2316
7330-L5	2324
	2801
	2103
	2104
	2108
	2109
	2112
	2115
	2116
	2117
	2118
	2138
	2139
2501	
2137	



7330-L2



7330-L8

Code	For digital/ dial indicators
7330-L6	2318
7330-L10	2307
	2326
7330-L10	2310
7330-L11	2114

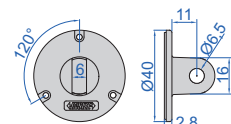

7330-L1

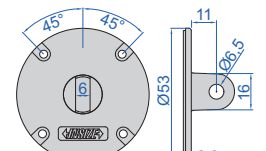

7330-L2 and 7330-L10

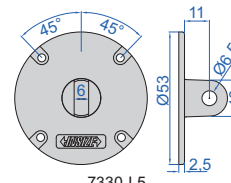

7330-L5

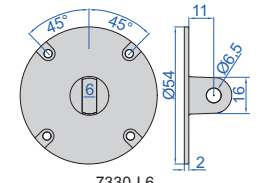

7330-L6

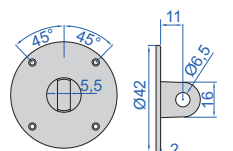

7330-L11

Unit: mm

MEASURING TOOLS DYNAMOMETERS

REFER TO PAGE 187 FOR DETAILS



check the measuring force of dial test indicators



check the measuring force of dial indicators



ISF-DGD15

DIAL INDICATOR TESTER CODE 2396-25A

ATTENTION: NOT SUITABLE FOR DIAL INDICATORS WITH GRADUATION 0.001MM



- To calibrate dial indicators, test indicators and dial bore gauges
- Dimension: 270x210x205mm
- Weight: 11kg

Micrometer head

Range	Sampling interval	Accuracy	Hysteresis
0-25mm	0.1mm	4µm (0-25mm), 3µm (0-10mm), 2µm (0-1mm)	1µm

Force gauge

Range	Graduation	Accuracy
0-1.6N	0.05N	±5% (of load capacity)

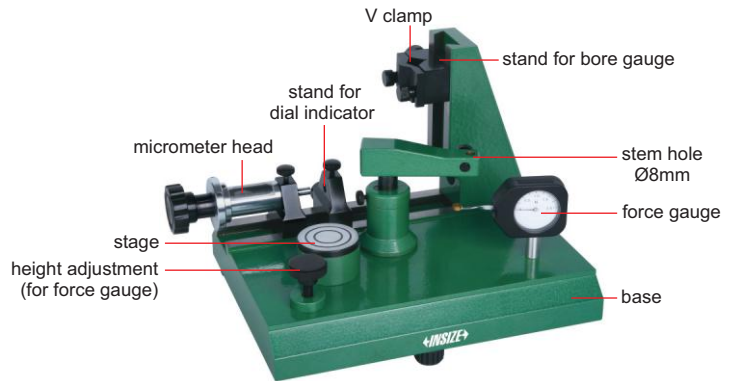

2396-25A

Stage

Diameter	Flatness	Roughness
50mm	1µm	0.05µm



inspect accuracy of dial indicators (range 0-25mm)



inspect accuracy of dial bore gauges (range 6-450mm)



inspect accuracy of test indicators



check force of dial indicators



check repeatability of dial indicators



check the effect of lateral force on accuracy of dial indicators (half round gauge block is needed)



check the effect of lateral force on accuracy of test indicators (half round gauge block is needed)

Half round gauge block (optional)

Code	Parallelism
2396-block	1µm

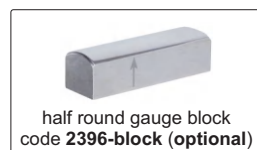

half round gauge block code 2396-block (optional)

DIAL TEST INDICATOR UNIVERSAL HOLDER



6297-1

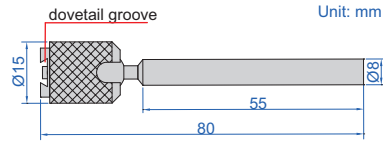

Code
6297-1

- Set the indicators at the desired attitude to the workpiece

DIAL TEST INDICATOR HOLDER



6296-1

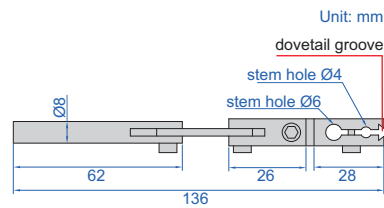

Code
6296-1

- Supplied with hex key

10

DIAL TEST INDICATOR HOLDERS



6293-1

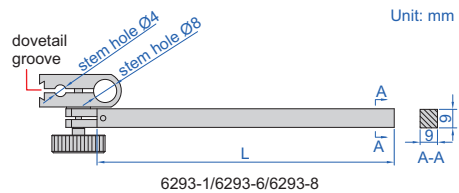

6293-2

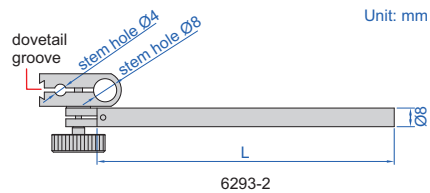

Code	Stem section	Stem length (L)
6293-1	9x9mm	100mm
6293-6	9x9mm	50mm
6293-8 *	9x9mm	200mm
6293-2	Ø8mm	115mm

* Only apply for 0.01mm dial test indicator



DIAL TEST INDICATOR HOLDER

- Can be used with dial test indicators



6291-1

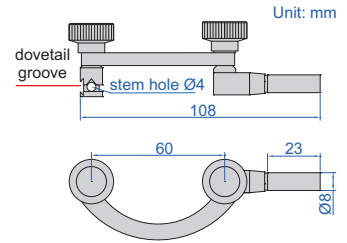

Code
6291-1

DIAL TEST INDICATOR HOLDER

- Can be used with dial test indicators



6295-1A

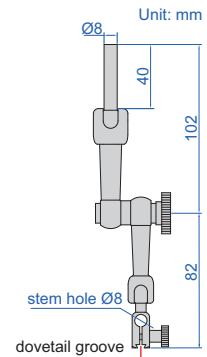

Code
6295-1A

DIAL INDICATOR HOLDER

- Can be used with dial test indicators or dial indicators



6294-1A

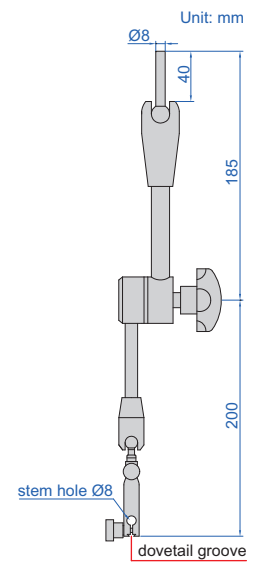

Code
6294-1A

HYDRAULIC UNIVERSAL MAGNETIC STANDS

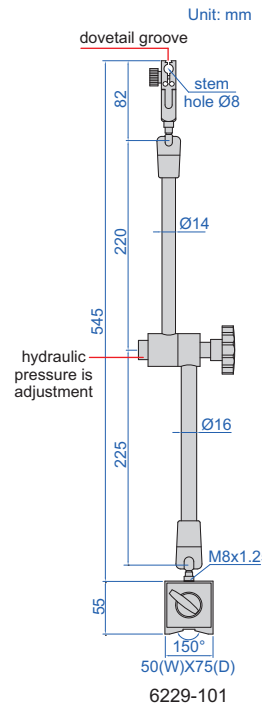
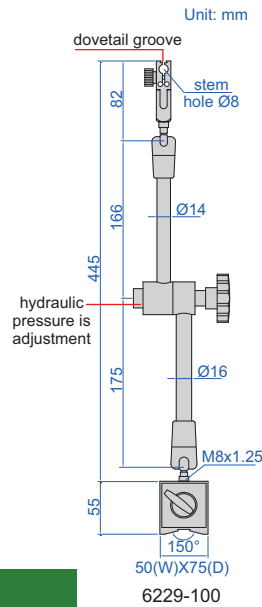
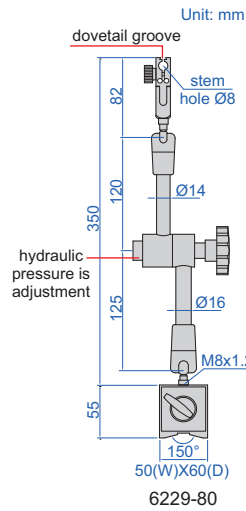
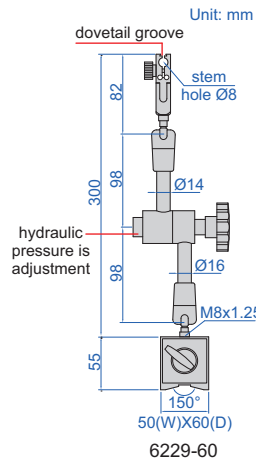

- Hydraulic pressure is adjustment
- For digital/dial indicators and dial test indicators

Code	Magnetic force	Applicable holding stem	Remark
6229-60	60kgf	Ø8mm	with fine adjustment and dovetail groove
6229-80	80kgf	Ø8mm	with fine adjustment and dovetail groove
6229-100	100kgf	Ø8mm	with fine adjustment and dovetail groove
6229-101	100kgf	Ø8mm	with fine adjustment and dovetail groove

LARGE LOCKING FORCE MAGNETIC STAND

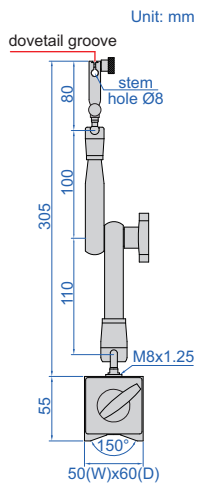

- For digital/dial indicators and dial test indicators

Code	Magnetic force	Applicable holding stem	Remark
6219-80	80kgf	Ø8mm	with fine adjustment and dovetail groove

UNIVERSAL MAGNETIC STANDS

POPULAR MODEL

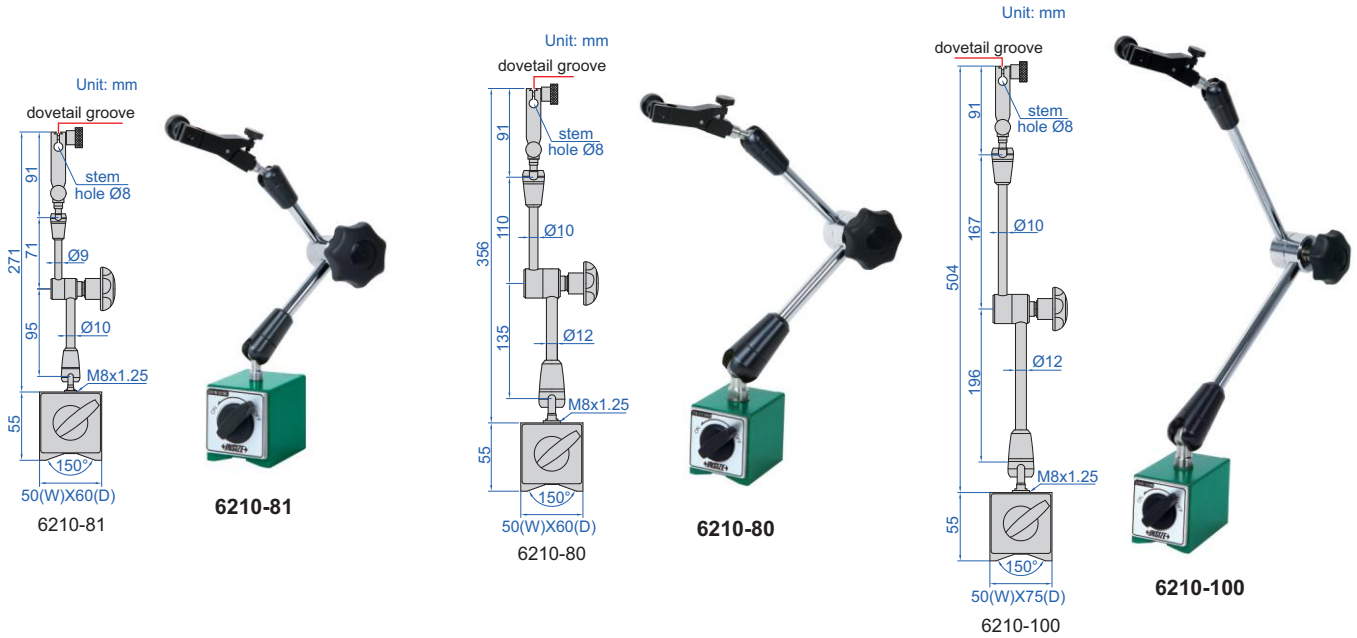

- For digital/dial indicators and dial test indicators

10

Code	Magnetic force	Applicable holding stem	Remark
6210-81	80kgf	Ø8mm	with fine adjustment and dovetail groove
6210-80	80kgf	Ø8mm	with fine adjustment and dovetail groove
6210-100	100kgf	Ø8mm	with fine adjustment and dovetail groove

MAGNETIC STAND WITH TWO FINE ADJUSTMENTS

- With two fine adjustments on the head and on the base
- For digital/dial indicators and dial test indicators

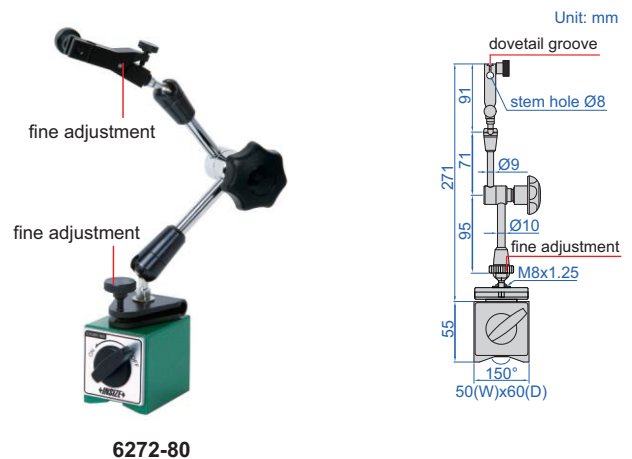

Code	Magnetic force	Applicable holding stem	Remark
6272-80	80kgf	Ø8mm	with two fine adjustments and dovetail groove

ATTENTION: FOR DIAL TEST INDICATORS ONLY

HYDRAULIC MINI MAGNETIC STAND

- For dial test indicators
- With fine adjustment and dovetail groove
- Adjustable hydraulic force



6228-40

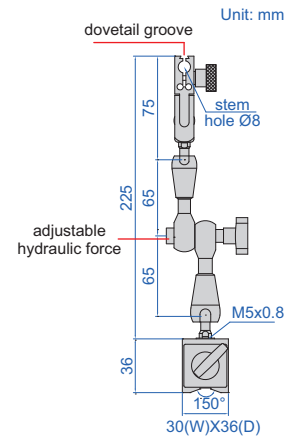

Code	Magnetic force	Applicable holding stem
6228-40	40kgf	Ø8mm

ATTENTION: FOR DIAL TEST INDICATORS ONLY

MINI MAGNETIC STAND

- For dial test indicators
- With fine adjustment and dovetail groove



6224-40

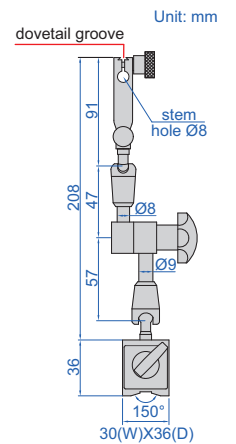

Code	Magnetic force	Applicable holding stem
6224-40	40kgf	Ø8mm

MAGNETIC STAND (FOR 0.001MM DIAL AND TEST INDICATORS)

- For 0.001mm and 0.01mm dial and test indicators

Code	Magnetic force	Applicable holding stem	Remark
6221-80	80kgf	Ø8mm	with fine adjustment and dovetail groove



6221-80

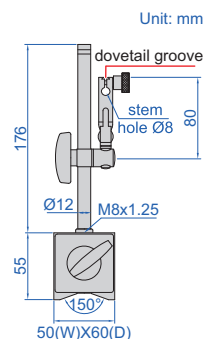

MAGNETIC STANDS

POPULAR MODEL



6200-60



6201-60



6202-80



6202-100

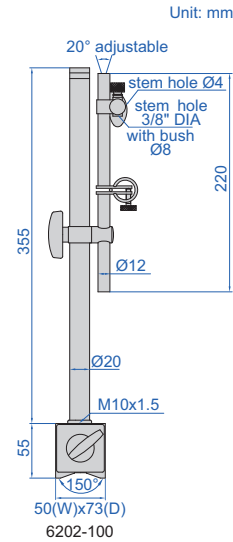
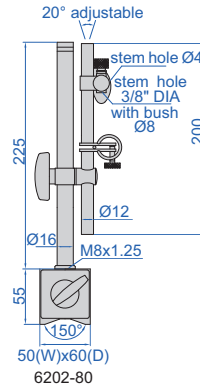
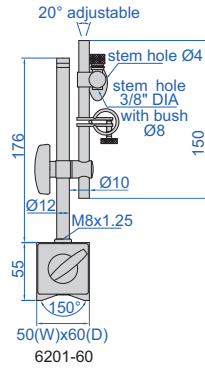
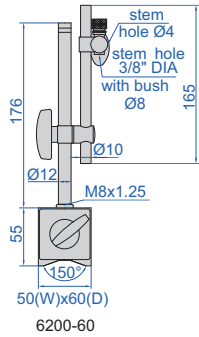

10

- For digital/dial indicators and dial test indicators

Code	Magnetic force	Applicable holding stem	Remark
6200-60	60kgf	Ø8mm, Ø4mm, 3/8" DIA	without fine adjustment
6201-60	60kgf	Ø8mm, Ø4mm, 3/8" DIA	with fine adjustment
6202-80	80kgf	Ø8mm, Ø4mm, 3/8" DIA	with fine adjustment
6202-100	100kgf	Ø8mm, Ø4mm, 3/8" DIA	with fine adjustment

MAGNETIC STAND



6231-60

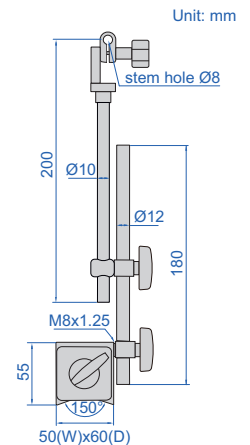

- For digital/dial indicators and dial test indicators

Code	Magnetic force	Applicable holding stem	Remark
6231-60	60kgf	Ø8mm	without fine adjustment or dovetail groove

MAGNETIC STAND

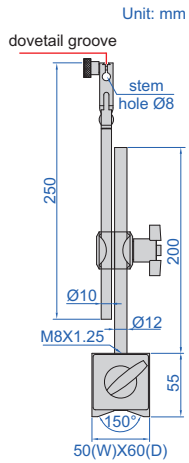

6216-80

- For digital/dial indicators and dial test indicators

Code	Magnetic force	Applicable holding stem	Remark
6216-80	80kgf	Ø8mm	with fine adjustment and dovetail groove

MAGNETIC STAND FOR UNEVEN SURFACES

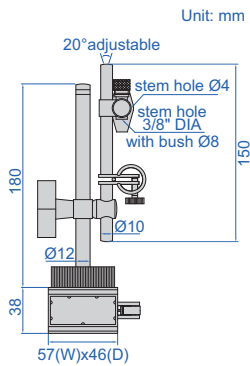

6215-60

- For digital/dial indicators and dial test indicators
- With fine adjustment

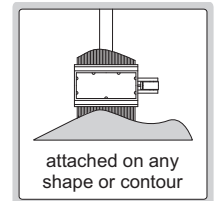

Code	Magnetic force	Applicable holding stem
6215-60	60kgf	Ø8mm, Ø4mm, 3/8" DIA

MINI MAGNETIC STAND

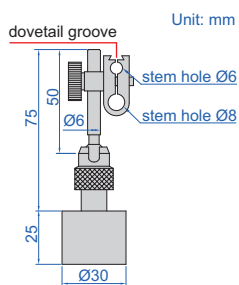

6211-10

ATTENTION: FOR DIAL TEST INDICATORS ONLY

- For dial test indicators
- With dovetail groove

Code	Magnetic force	Applicable holding stem
6211-10	10kgf	Ø6mm, Ø8mm

MAGNETIC BASES



6212-80

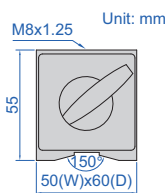

6212-80



6212-100

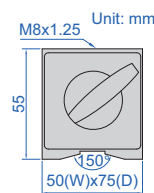

6212-100

Code	Magnetic force
6212-80	80kgf
6212-100	100kgf

FLEX ARM MAGNETIC STAND

ATTENTION: FOR DIAL TEST INDICATORS ONLY

- For dial test indicators

Code	Magnetic force	Applicable holding stem
6207-80A	80kgf	Ø8mm, Ø4mm, 3/8" DIA



6207-80A

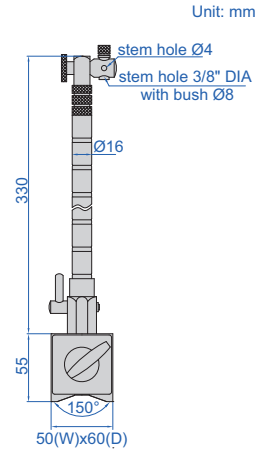

VACUUM STAND

10

- Suitable for granite surface plates or cast iron surface plates
- For digital/dial indicators and dial test indicators

Code	Diameter of vacuum disc	Vacuum force	Applicable holding stem	Remark
6217-B	Ø80mm	80kgf	Ø8mm	with fine adjustment and dovetail groove



6217-B

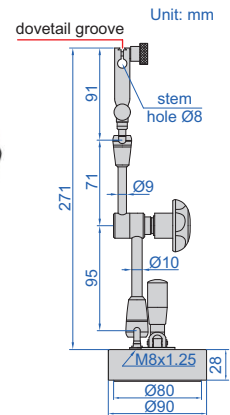

UNIVERSAL STAND

- For digital/dial indicators and dial test indicators
- With fine adjustment



6214-A

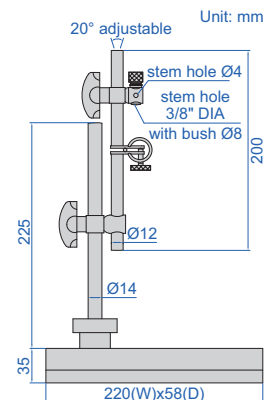

Code	Applicable holding stem
6214-A	Ø8mm, Ø4mm, 3/8" DIA

DIAL INDICATOR STAND (FOR 0.001MM DIAL AND TEST INDICATORS)

- Non-magnetic and hardened base
- Suitable for granite surface plates or cast iron surface plates
- For 0.001mm and 0.01mm dial and test indicators



6230-60

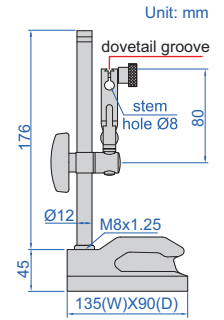

Code	Applicable holding stem	Remark
6230-60	Ø8mm	with fine adjustment and dovetail groove

DIAL INDICATOR STANDS (NON-MAGNETIC)



6226-60



6226-80



6226-100

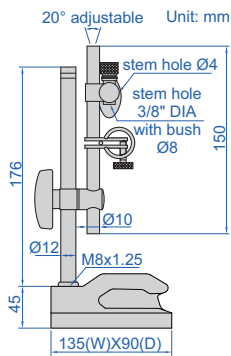

6226-60

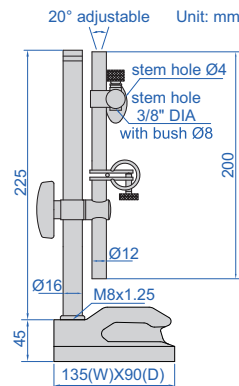

6226-80

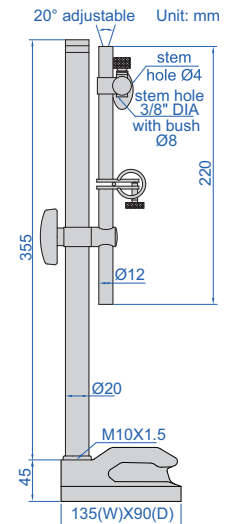

6226-100

Code	Applicable holding stem	Remark
6226-60	Ø8mm, Ø4mm, 3/8" DIA	with fine adjustment
6226-80	Ø8mm, Ø4mm, 3/8" DIA	with fine adjustment
6226-100	Ø8mm, Ø4mm, 3/8" DIA	with fine adjustment

- Hardened base
- Suitable for granite surface plates and cast iron surface plates
- For digital/dial indicators and dial test indicators

UNIVERSAL DIAL INDICATOR STANDS (NON-MAGNETIC)



6225-80

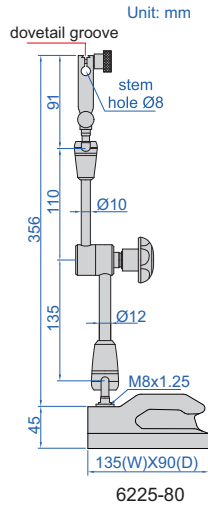

6225-80



6225-100

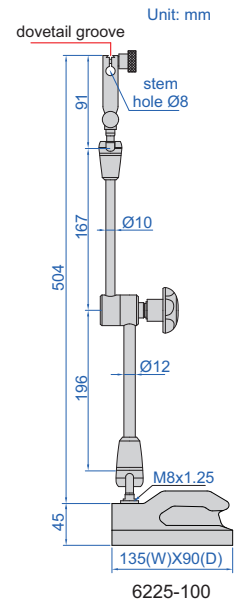

6225-100

- Hardened base
- Suitable for granite surface plates and cast iron surface plates
- For digital/dial indicators and dial test indicators

10

Code	Applicable holding stem	Remark
6225-80	Ø8mm	with fine adjustment and dovetail groove
6225-100	Ø8mm	with fine adjustment and dovetail groove

DIAL INDICATOR STAND (NON-MAGNETIC)



6227-80

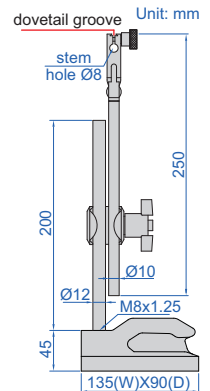

- Hardened base
- Suitable for granite surface plates and cast iron surface plates
- For digital/dial indicators and dial test indicators

Code	Applicable holding stem	Remark
6227-80	Ø8mm	with fine adjustment and dovetail groove

DIAL INDICATOR STANDS

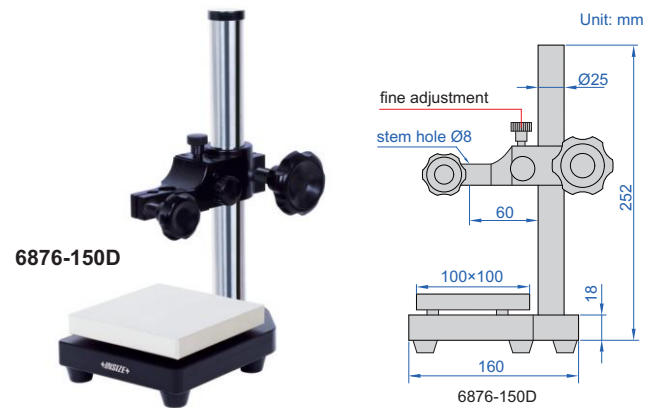
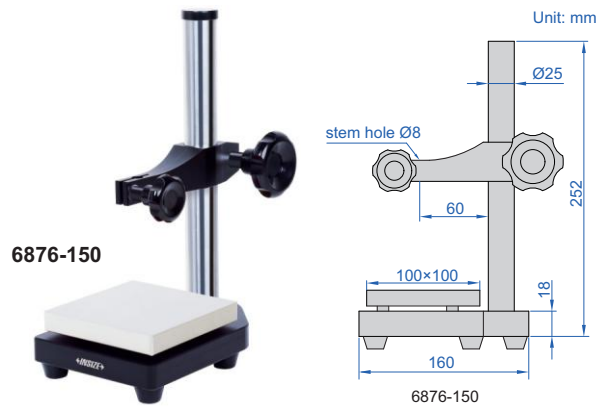

Code	Applicable holding stem	Anvil	Remark
6876-150	Ø8mm	ceramic, plain, flatness 1.5µm	without fine adjustment
6876-150D	Ø8mm	ceramic, plain, flatness 1.5µm	with fine adjustment, fine adjustment range 3mm

- Vertical travel of holder: 150mm
- Ceramic anvil
- Supplied with dust cover

POPULAR MODEL

GRANITE DIAL INDICATOR STANDS (BASIC TYPE)

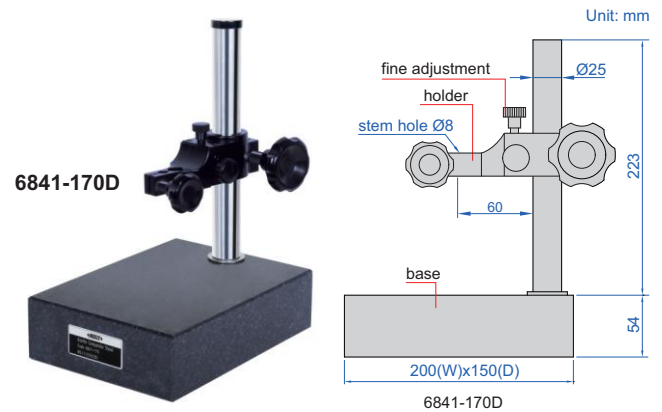
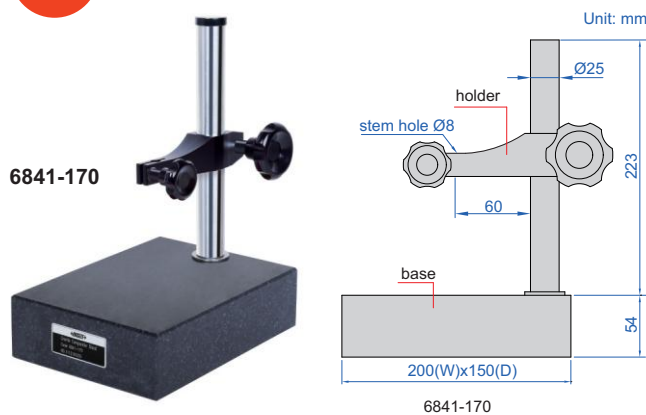

Code	Applicable holding stem	Base	Remark
6841-170	Ø8mm	flatness 2.5µm	without fine adjustment
6841-170D	Ø8mm	flatness 2.5µm	with fine adjustment, fine adjustment range 3mm

- Vertical travel of holder: 170mm
- Supplied with dust cover

GRANITE DIAL INDICATOR STAND

- Vertical travel of holder: 150mm
- Fine adjustment range: 2mm
- Supplied with dust cover

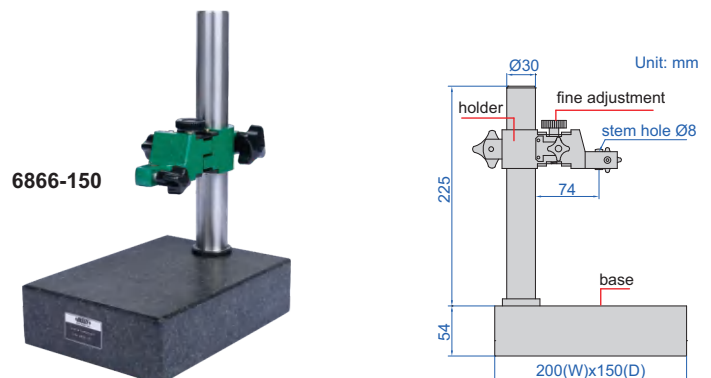

Code	Applicable holding stem	Base
6866-150	Ø8mm	flatness 2.5µm

GRANITE DIAL INDICATOR STANDS

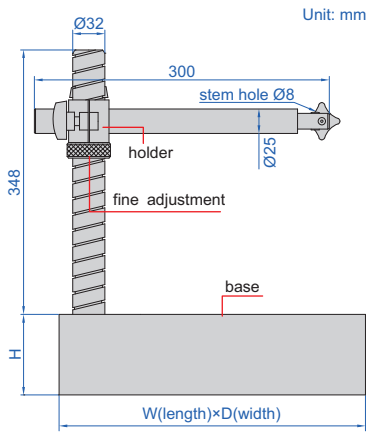

6867-250



6867-400

- Vertical travel of holder: 250mm
- Fine adjustment range: entire stroke
- Supplied with dust cover

Code	Applicable holding stem	W	D	H	Base
6867-250	Ø8mm	300mm	300mm	75mm	flatness 2.8µm
6867-400	Ø8mm	400mm	300mm	100mm	flatness 3µm

10

DIGITAL GROOVE MEASUREMENT STANDS

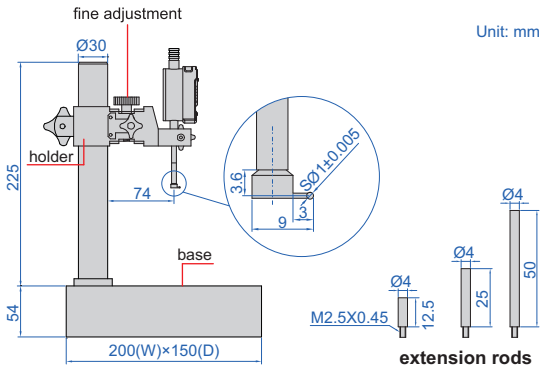

6870-150

DATA OUTPUT



- Button function: on/off, zero, mm/inch, measuring direction change, data preset, absolute/incremental measurement
- Vertical travel of holder: 150mm
- Fine adjustment range: 2mm
- CR2032 battery, automatic power off (time is adjustable)
- Data output
- Supplied with extension rods: 12.5mm (1pc), 25mm (1pc), 50mm (1pc)
- Supplied with groove point and dust cover
- Optional accessory:
 - wireless transmitter code **7315-50M** (receiver is needed) page 6,
 - bluetooth transmitter code **7214-50M** page 12,
 - data output cable code **7302-40M** page 21

measure width (b) and depth (a) of groove

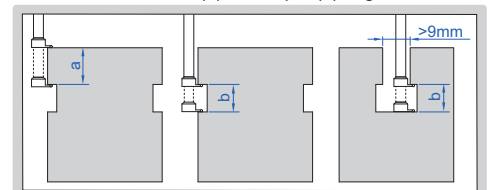

Code	Digital indicator stroke	Digital indicator resolution	Accuracy	Applicable holding stem	Base
6870-150	12.7mm/0.5"	0.01mm/0.0005"	±20µm	Ø8mm	flatness 2.5µm
6870-1501	12.7mm/0.5"	0.001mm/0.00005"	±5µm	Ø8mm	flatness 2.5µm

DIAL INDICATOR STANDS

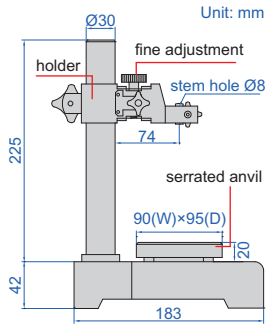

- Vertical travel of holder: 150mm
- Fine adjustment range: 2mm
- Supplied with dust cover

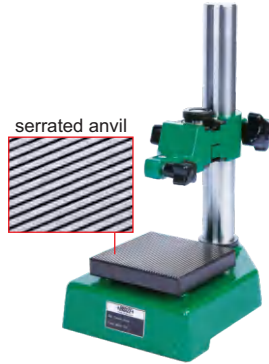

6863-150

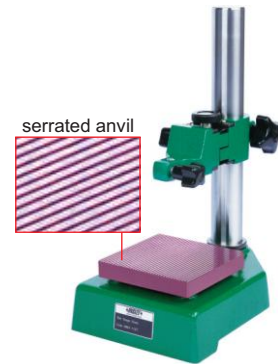

6863-150T

Code	Applicable holding stem	Anvil
6863-150	Ø8mm	steel (hardness HRC60±2), serrated, flatness 1.5µm
6863-150T	Ø8mm	ceramic, serrated, flatness 1.5µm

DIAL INDICATOR STANDS

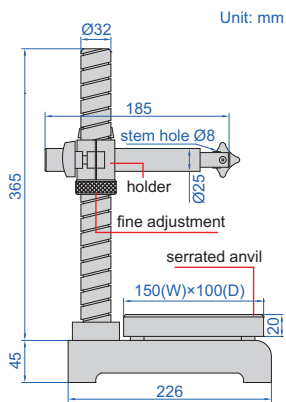

- Vertical travel of holder: 250mm
- Fine adjustment range: entire stroke
- Supplied with dust cover

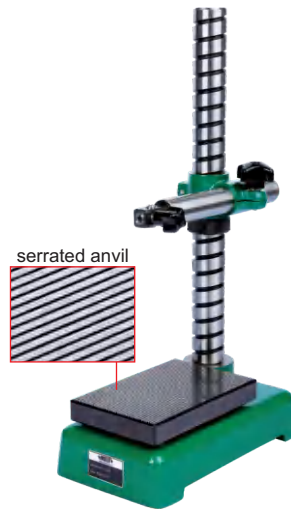

6864-250

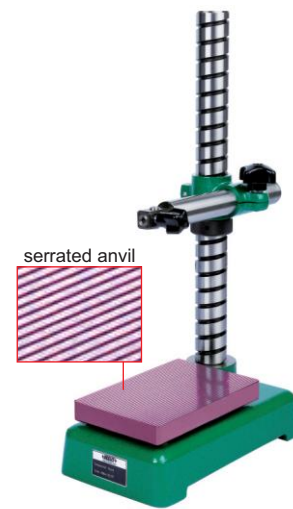

6864-250T

Code	Applicable holding stem	Anvil
6864-250	Ø8mm	steel (hardness HRC60±2), serrated, flatness 1.5µm
6864-250T	Ø8mm	ceramic, serrated, flatness 1.5µm

DIAL INDICATOR STANDS



6862-1001



6862-1002

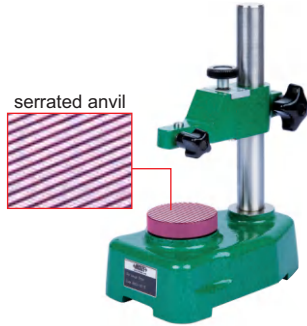
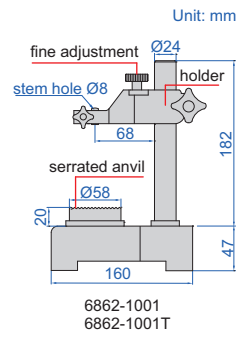

6862-1001T



6862-1002T

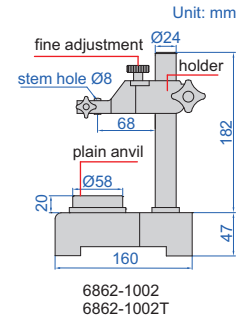

10

- Vertical travel of holder: 100mm
- Fine adjustment range: 2mm
- Supplied with dust cover

Code	Applicable holding stem	Anvil
6862-1001	Ø8mm	steel (hardness HRC60±2), serrated, flatness 1.5µm
6862-1002	Ø8mm	steel (hardness HRC60±2), plain, flatness 1.5µm
6862-1001T	Ø8mm	ceramic, serrated, flatness 1.5µm
6862-1002T	Ø8mm	ceramic, plain, flatness 1.5µm

DIAL INDICATOR STAND



6861-250

- Vertical travel of holder: 250mm
- Fine adjustment range: 1mm
- Supplied with dust cover

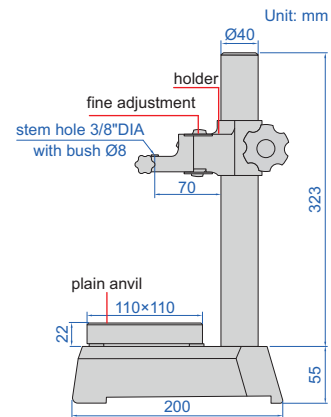

Code	Applicable holding stem	Anvil
6861-250	Ø8mm, 3/8"	ceramic, plain, flatness 1.5µm

HEAVY DUTY DIAL INDICATOR STAND

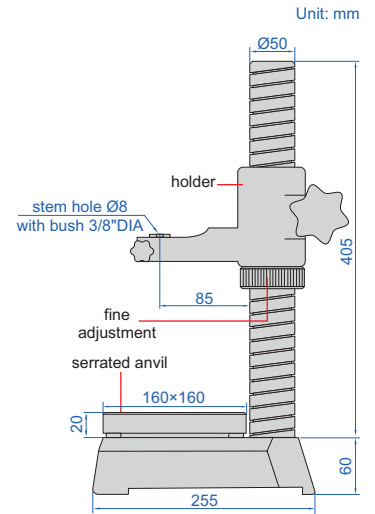

- Vertical travel of holder: 300mm
- Fine adjustment range: entire stroke
- Supplied with dust cover

6868-300

Code	Applicable holding stem	Anvil
6868-300	Ø8mm, 3/8"	steel (hardness HRC60±2), serrated, flatness 1.5µm

10

HEAVY DUTY DIAL INDICATOR STAND

digital/dial indicator
is optional

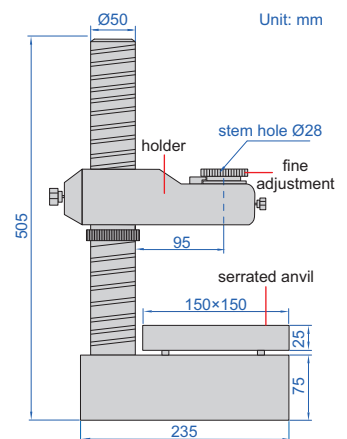

- Vertical travel of holder: 300mm
- Holder fine adjustment range: entire stroke
- Indicator fine adjustment range: 5mm
- Optional accessory: high precision digital indicators (code 2140 series, 2150 series), gauge blocks (4101 series, for zero setting)

6877-300

Code	Applicable holding stem	Anvil
6877-300	Ø28mm	steel (hardness HRC60±2), serrated, flatness 2µm

HEAVY DUTY DIAL INDICATOR STAND



- Vertical travel of holder: 300mm
- Fine adjustment range: 5mm
- Carbide base
- Supplied with dust cover
- Optional accessory:
holder with stem hole $\varnothing 28$ (code **6869-D28**)

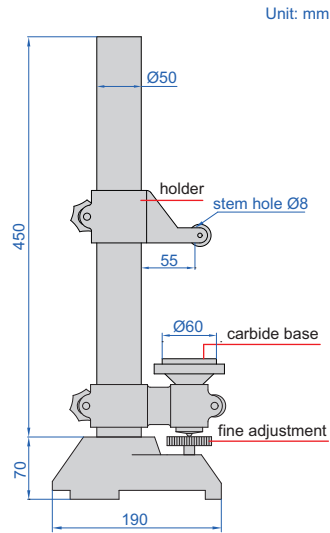

6869-300

Code	Applicable holding stem	Base
6869-300	$\varnothing 8$ mm	plain, flatness $1\mu\text{m}$, carbide

DIAL INDICATOR STAND

GUAGE BLOCKS ARE NEEDED FOR ZERO SETTING



10

locating fork for workpieces (included)



digital/dial indicator is optional



6845-100

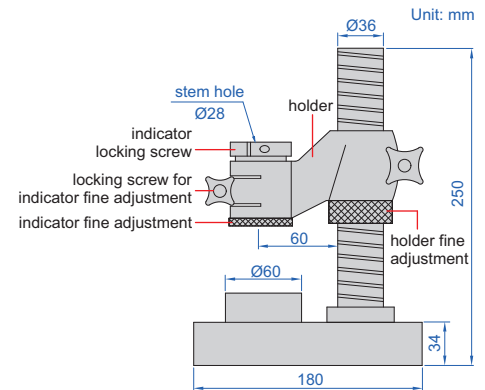

- Vertical travel of holder: 100mm
- Holder fine adjustment range: entire stroke
- Indicator fine adjustment range: 3mm
- Optional accessory: $\varnothing 28$ mm/ $\varnothing 8$ mm bush (code **6843-B8**), 0.001mm digital/dial indicators, high precision digital indicators (code **2140** series, **2150** series), gauge blocks (**4101** series, for zero setting)

$\varnothing 28$ mm/ $\varnothing 8$ mm bush (optional)



Code
6843-B8

application



Code	Applicable holding stem	Anvil
6845-100	$\varnothing 28$ mm	serrated, flatness $1\mu\text{m}$

GAUGE BLOCKS ARE NEEDED FOR ZERO SETTING



DIAL INDICATOR STAND



6846-140

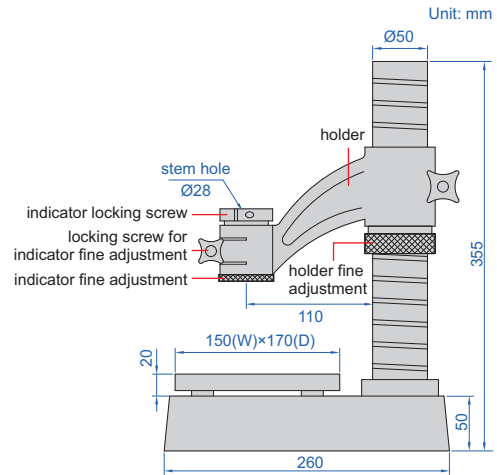

- Vertical travel of holder: 140mm
- Holder fine adjustment range: entire stroke
- Indicator fine adjustment range: 3mm
- Optional accessory: Ø28mm/Ø8mm bush (code **6843-B8**), 0.001mm digital/dial indicators, high precision digital indicators (code **2140** series, **2150** series), gauge blocks (**4101** series, for zero setting)

Code	Applicable holding stem	Anvil
6846-140	Ø28mm	grid, flatness 1µm

locating fork for workpieces (included)



Ø28mm/Ø8mm bush (optional)



Code
6843-B8

application



DIAL INDICATOR STAND

GAUGE BLOCKS ARE NEEDED FOR ZERO SETTING



digital/dial indicator is optional

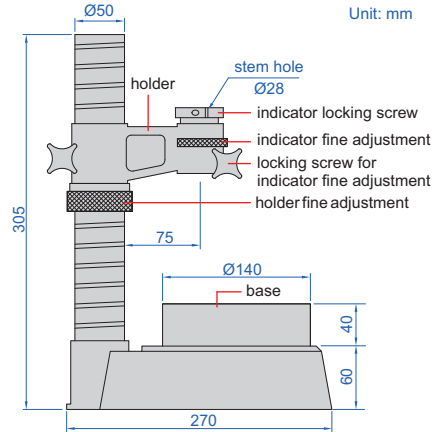

6842-150

locating fork for workpiece (included)



rotary lever probe (included)



base with step (included)



10

- Vertical travel of holder: 180mm
- Holder fine adjustment range: entire stroke
- Indicator fine adjustment range: 10mm
- Optional accessory: Ø28mm/Ø8mm bush (code 6843-B8), 0.001mm digital/dial indicators, high precision digital indicators (code 2140 series, 2150 series), gauge blocks (4101 series, for zero setting)

the tip of rotary lever probe can reach narrow areas

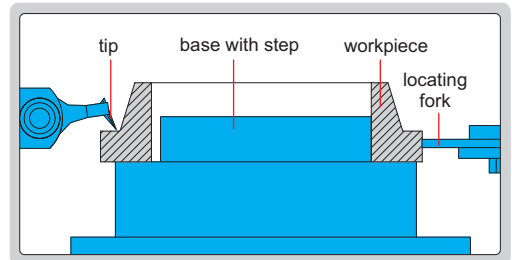

Code	Applicable holding stem	Base
6842-150	Ø28mm	flatness 2µm

Ø28mm/Ø8mm bush (optional)



Code
6843-B8

application



locating fork for workpieces

base with step

rotary lever probe

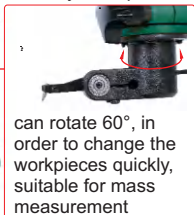

TRANSFER STANDS

application



rigid construction, designed to make comparison height measurement (set zero with gauge block then measure height of workpiece) with dial indicators or digital indicators (variation of measuring force is high)



6865-300



6865-300T

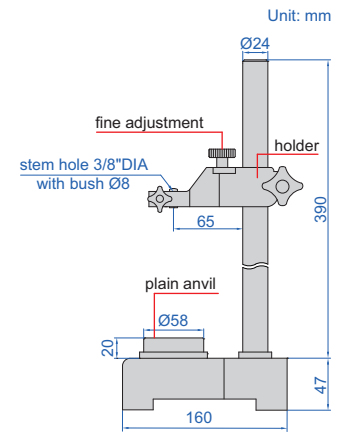

- Vertical travel of holder: 335mm
- Fine adjustment range: 2mm
- Supplied with dust cover

Code	Applicable holding stem	Anvil
6865-300	3/8" DIA, $\varnothing 8$ mm	steel (hardness HRC60 \pm 2), plain, flatness 1.5 μ m
6865-300T	3/8" DIA, $\varnothing 8$ mm	ceramic, plain, flatness 1.5 μ m

REFER TO PAGE 102-104 FOR DETAILS

DIGITAL HEIGHT GAUGES



1155-505



1157-501



1158-100



Internal Caliper Gauges
Page 301-306



External Caliper Gauges
Page 306-307



Thickness Gauges
Page 308-315



**Geomembrane
Thickness Gauges**
Page 315



Rubber Thickness Gauges
Page 316-317



Leather Thickness Gauges
Page 318



Tube Thickness Gauges
Page 318-320



**Thread/Lead Screw Pitch
Diameter Snap Gauges**
Page 320



Snap Gauges
Page 321-323



Step And Gap Gauges
Page 324



Mini Digital Height Gauges
Page 324-325



Height Gauges
Page 325-326



Crankshaft Testers
Page 326



**Perpendicularity/Parallelism
Comparison Gauges**
Page 327



**Thread Pitch Measuring
Instruments**
Page 329-330



**Buttress Thread
Run-out Gauges**
Page 330



Buttress Thread Tooth Thickness Gauges
Page 331

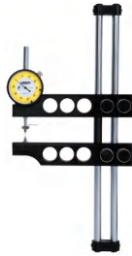

Thread Taper Measuring Instruments
Page 332-334



Thread Height Measuring Instruments
Page 335-336



Thread Height Measuring Instruments
Page 337



Thread Crest Diameter Measuring Instruments
Page 338-341



Groove Diameter Measuring Instruments
Page 342



Groove Width Measuring Instruments
Page 343

DIGITAL INTERNAL CALIPER GAUGES

DATA
OUTPUT



2121-15

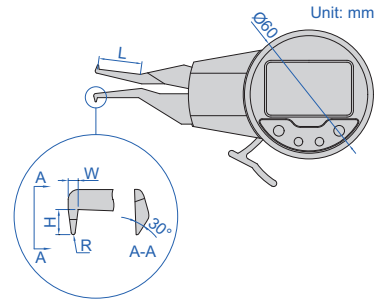

- Resolution: 0.005mm/0.0002"
- Reading in digit and analog
- Display can be rotated by 170°
- Button function: tolerance Go and No-Go display, data preset, max./min. measurement, data holding, inch/metric conversion, absolute/incremental measurement
- CR2032 battery, automatic power off
- Data output
- Optional accessory:
wireless transmitter code **7315-30** (receiver is needed) page 5,
bluetooth transmitter code **7214-30** page 11,
data output cable code **7302-30** page 20

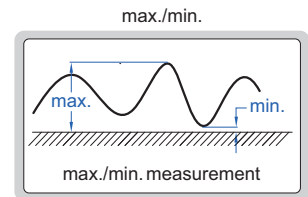
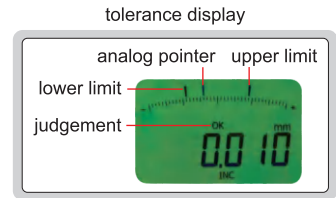
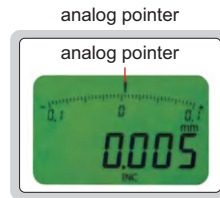

Code	Range	Accuracy	Repeatability	L	H	W	R
2121-15	5-15mm/0.2-0.6"	±0.03mm	0.01mm	20	2	1.5	R0.3
2121-25	5-25mm/0.2-1.0"	±0.03mm	0.01mm	35	1.5	1.0	R0.3
2121-31	10-30mm/0.4-1.2"	±0.03mm	0.01mm	55	5.5	2.5	R0.5
2121-41	20-40mm/0.8-1.6"	±0.03mm	0.01mm	80	6.0	3.0	R0.5
2121-51	30-50mm/1.2-2.0"	±0.03mm	0.01mm	80	8.0	3.0	R0.5
2121-61	40-60mm/1.6-2.4"	±0.03mm	0.01mm	80	8.0	3.0	R0.5

INTERNAL DIAL CALIPER GAUGES



2222-15

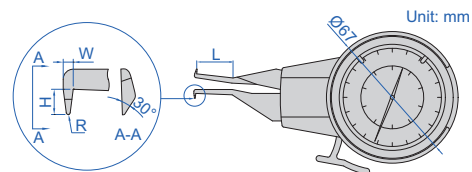

Code	Range	Graduation	Accuracy	L	H	W	R
2222-15	5-15mm	0.01mm	±0.03mm	20	2	1.5	R0.3
2222-25	5-25mm	0.01mm	±0.03mm	35	1.5	1.0	R0.3
2222-301	10-30mm	0.01mm	±0.03mm	55	5.5	2.5	R0.5
2222-401	20-40mm	0.01mm	±0.03mm	80	6.0	3.0	R0.5
2222-501	30-50mm	0.01mm	±0.03mm	80	8.0	3.0	R0.5
2222-60	40-60mm	0.01mm	±0.03mm	80	8.0	3.0	R0.5

DATA OUTPUT

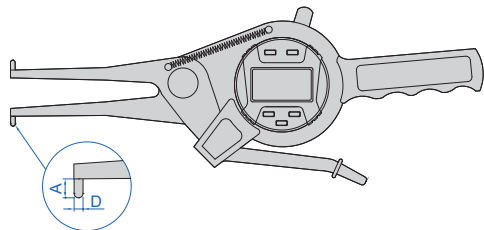

- Carbide measuring tips
- Reading in digit and analog
- With transmission button and signal light
- Display can be rotated by 320°
- Button function: on/off, zero, tolerance Go and No-Go display, data preset, measuring direction change, max./min./TIR measurement, inch/metric conversion, data output, absolute/incremental measurement
- CR2032 battery, automatic power off (time is adjustable)
- Data output
- Optional accessory:
wireless transmitter code **7315-50M** (receiver is needed) page 6,
bluetooth transmitter code **7214-50M** page 12,
data output cable code **7302-50M** page 21

DIGITAL INTERNAL CALIPER GAUGES



2151-35

Code	Range	Resolution	Accuracy	L	A	D
2151-35	15-35mm/0.6-1.4"	0.01mm/0.0005"	±0.04mm	<50	3	Ø3
2151-AL35	15-35mm/0.6-1.4"	0.01mm/0.0005"	±0.04mm	<200	3	Ø3
2151-55	35-55mm/1.4-2.2"	0.01mm/0.0005"	±0.04mm	<80	6	Ø3
2151-AL55	35-55mm/1.4-2.2"	0.01mm/0.0005"	±0.04mm	<250	8	Ø3
2151-75	55-75mm/2.2-3"	0.01mm/0.0005"	±0.04mm	<90	8	Ø3
2151-AL75	55-75mm/2.2-3"	0.01mm/0.0005"	±0.04mm	<250	8	Ø3
2151-95	75-95mm/3-3.8"	0.01mm/0.0005"	±0.04mm	<100	8	Ø3
2151-115	95-115mm/3.8-4.6"	0.01mm/0.0005"	±0.04mm	<120	10	Ø3.2
2151-135	115-135mm/4.6-5.4"	0.01mm/0.0005"	±0.04mm	<120	10	Ø3.2

(mm)

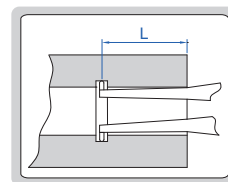

INTERNAL DIAL CALIPER GAUGES

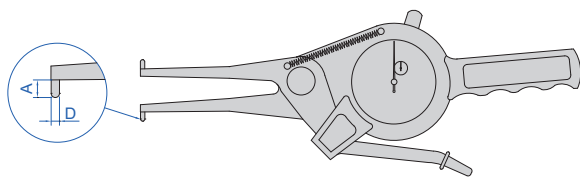

- Carbide measuring tips



2321-35

Code	Range	Graduation	Accuracy	L	A	D
2321-35	15-35mm	0.01mm	±0.04mm	<50	3	Ø3
2321-AL35	15-35mm	0.01mm	±0.04mm	<200	3	Ø3
2321-55	35-55mm	0.01mm	±0.04mm	<80	6	Ø3
2321-AL55	35-55mm	0.01mm	±0.04mm	<250	8	Ø3
2321-75	55-75mm	0.01mm	±0.04mm	<90	8	Ø3
2321-AL75	55-75mm	0.01mm	±0.04mm	<250	8	Ø3
2321-95	75-95mm	0.01mm	±0.04mm	<100	8	Ø3
2321-115	95-115mm	0.01mm	±0.04mm	<120	10	Ø3.2
2321-135	115-135mm	0.01mm	±0.04mm	<120	10	Ø3.2

(mm)

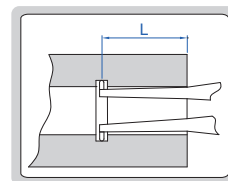

LARGE RANGE INTERNAL DIGITAL CALIPER GAUGES

DATA OUTPUT

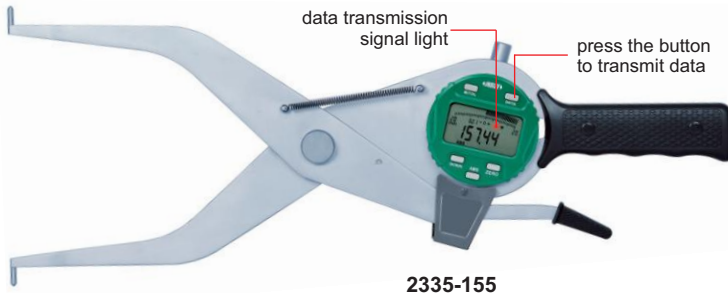

2335-155

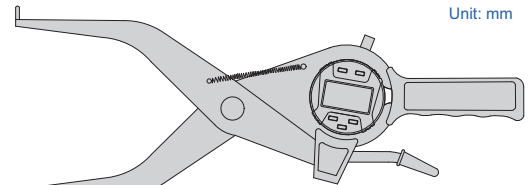

Unit: mm

type A

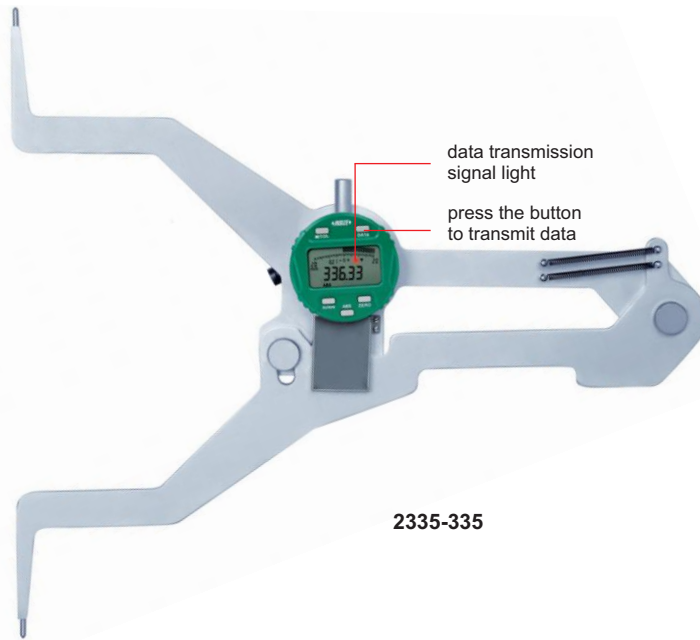
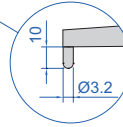

2335-335

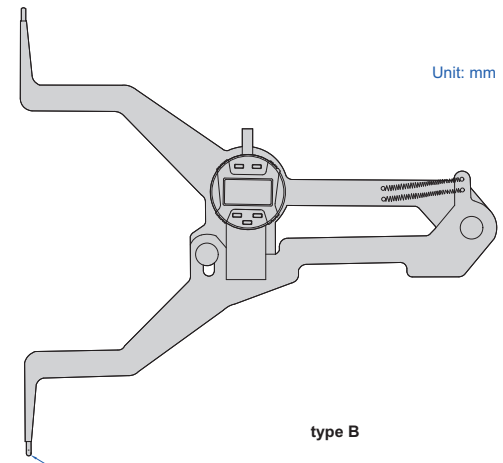

Unit: mm

type B

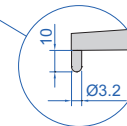

11

- Carbide measuring tips
- Reading in digit and analog
- With transmission button and signal light
- Display can be rotated by 320°
- Button function: on/off, zero, tolerance Go and No-Go display, data preset, measuring direction change, max./min./TIR measurement, inch/metric conversion, data output, absolute/incremental measurement
- CR2032 battery, automatic power off (time is adjustable)
- Data output
- Optional accessory: wireless transmitter code **7315-50M** (receiver is needed) page 6, bluetooth transmitter code **7214-50M** page 12, data output cable code **7302-50M** page 21

Code	Range	Resolution	Accuracy	Type	L
2335-155	135-155mm/5.32-6.10"	0.01mm/0.0005"	±0.04mm	A	<200mm
2335-175	155-175mm/6.10-6.89"	0.01mm/0.0005"	±0.04mm	A	<200mm
2335-195	175-195mm/6.88-7.68"	0.01mm/0.0005"	±0.04mm	A	<200mm
2335-215	195-215mm/7.68-8.46"	0.01mm/0.0005"	±0.04mm	A	<200mm
2335-235	215-235mm/8.46-9.25"	0.01mm/0.0005"	±0.04mm	A	<200mm
2335-255	235-255mm/9.25-10.04"	0.01mm/0.0005"	±0.04mm	A	<200mm
2335-275	255-275mm/10.04-10.83"	0.01mm/0.0005"	±0.04mm	A	<200mm
2335-295	275-295mm/10.83-11.61"	0.01mm/0.0005"	±0.04mm	A	<200mm
2335-315	295-315mm/11.61-12.40"	0.01mm/0.0005"	±0.04mm	A	<200mm
2335-335	315-335mm/12.40-13.19"	0.01mm/0.0005"	±0.04mm	B	<200mm
2335-355	335-355mm/13.19-13.98"	0.01mm/0.0005"	±0.04mm	B	<200mm
2335-375	355-375mm/13.98-14.76"	0.01mm/0.0005"	±0.04mm	B	<200mm

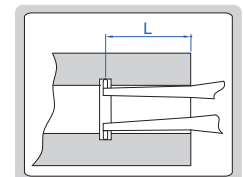

LARGE RANGE INTERNAL DIAL CALIPER GAUGES

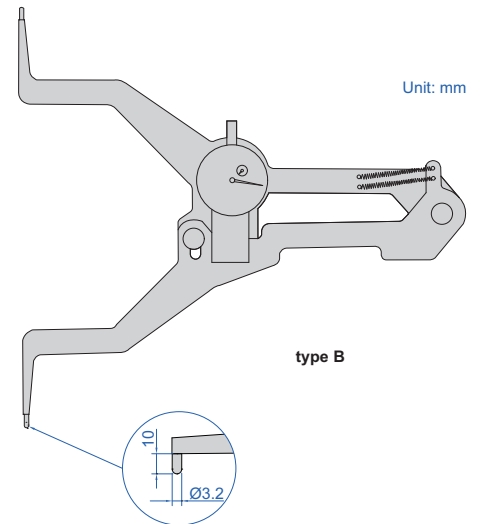
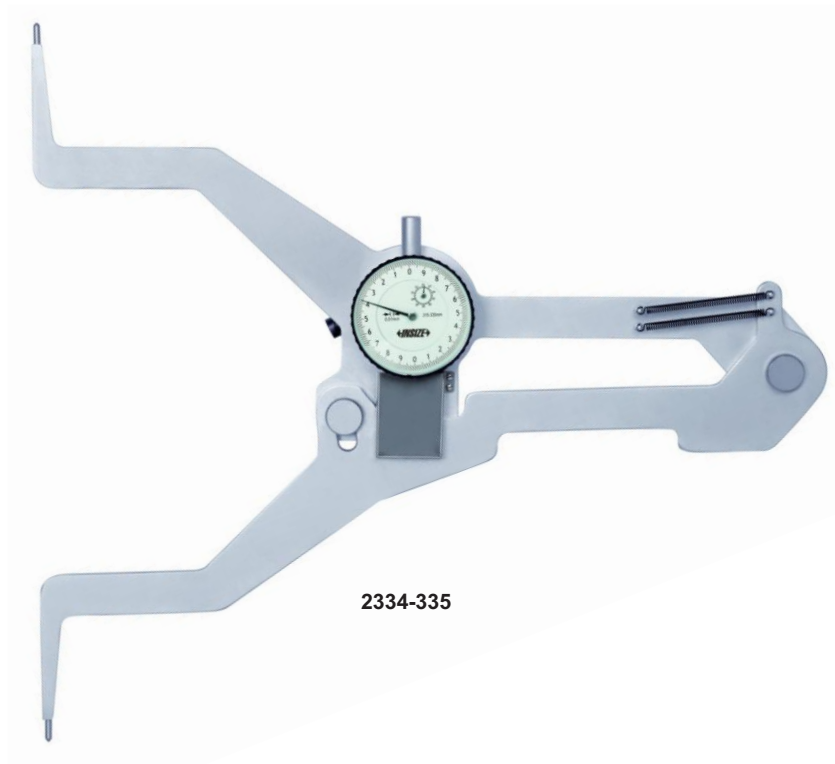
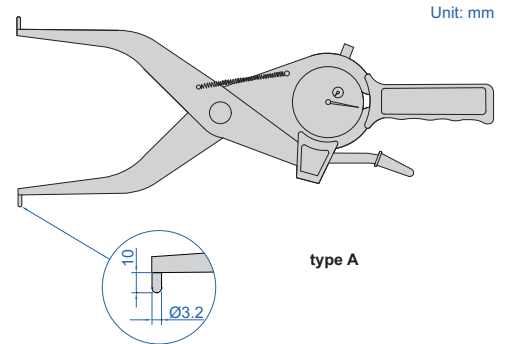

■ Carbide measuring tips

Code	Range	Graduation	Accuracy	Type	(mm) L
2334-155	135-155mm	0.01mm	±0.04mm	A	<200
2334-175	155-175mm	0.01mm	±0.04mm	A	<200
2334-195	175-195mm	0.01mm	±0.04mm	A	<200
2334-215	195-215mm	0.01mm	±0.04mm	A	<200
2334-235	215-235mm	0.01mm	±0.04mm	A	<200
2334-255	235-255mm	0.01mm	±0.04mm	A	<200
2334-275	255-275mm	0.01mm	±0.04mm	A	<200
2334-295	275-295mm	0.01mm	±0.04mm	A	<200
2334-315	295-315mm	0.01mm	±0.04mm	A	<200
2334-335	315-335mm	0.01mm	±0.04mm	B	<200
2334-355	335-355mm	0.01mm	±0.04mm	B	<200
2334-375	355-375mm	0.01mm	±0.04mm	B	<200

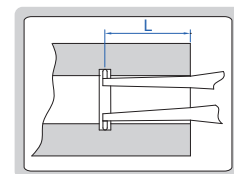

INTERNAL DIAL CALIPER GAUGES WITH INTERCHANGEABLE POINTS

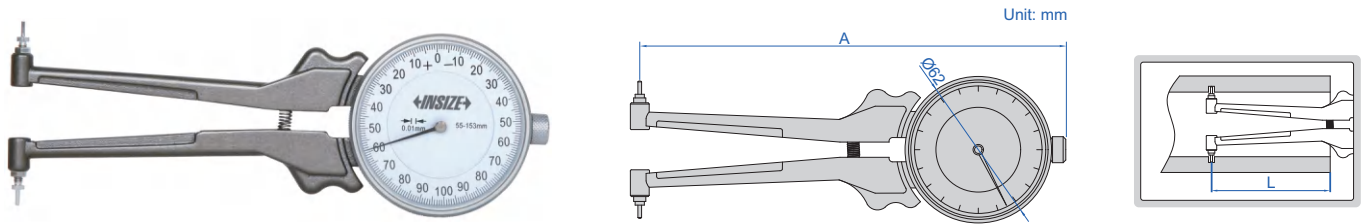

2223-153

Code	Range	Dial indicator range	Graduation	Accuracy	A	L	Remark
2223-35	20-35mm	2mm	0.01mm	±0.02mm	164mm	<70mm	supplied with 7 pairs of points
2223-62	30-62mm	2mm	0.01mm	±0.02mm	170mm	<75mm	supplied with 5 pairs of points
2223-153	55-153mm	2mm	0.01mm	±0.02mm	179mm	<90mm	supplied with 6 pairs of points

2223-35 points (included)

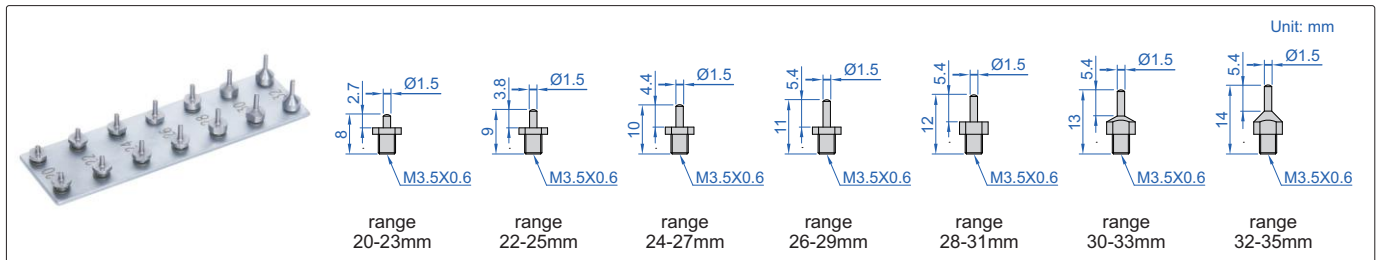

2223-62 points (included)

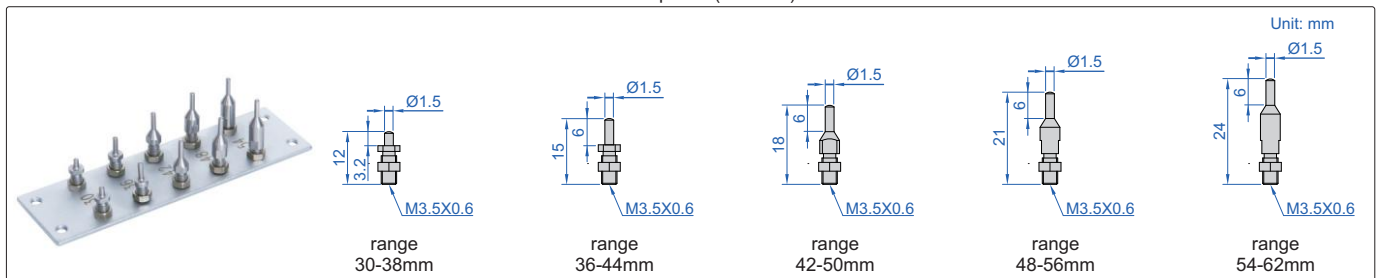

2223-153 points (included)

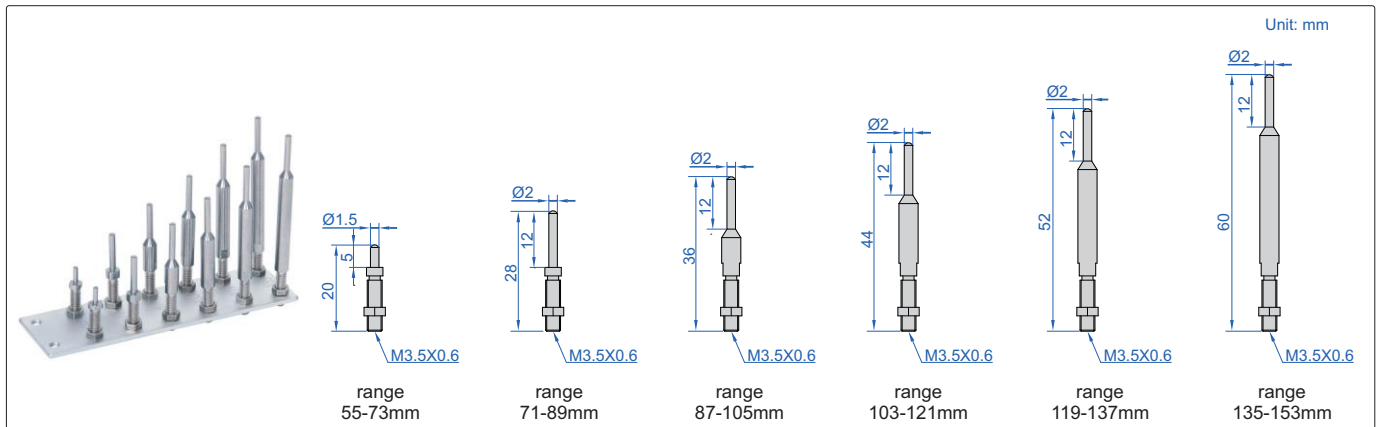

DIGITAL INTERNAL CALIPER GAUGES (ECONOMIC TYPE)



2711-165

sizes to be measured

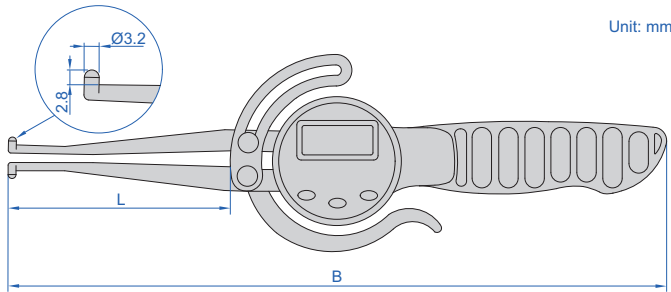
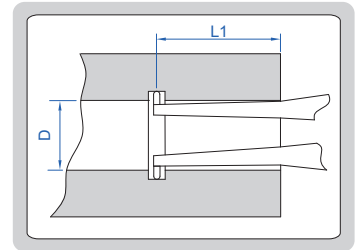

Unit: mm

- Button function: on/off, zero, mm/inch, data hold
- Battery CR2032, automatic power off

(mm)		(mm)	
Code 2711-165	L1	Code 2711-216	L1
Ø13	<42	Ø13	<50
Ø15	<45	Ø15	<55
Ø17	<50	Ø17	<60
Ø20	<60	Ø20	<65
Ø25	<75	Ø25	<75
Ø27	<80	Ø30	<95
Ø29~165	<85	Ø35~216	<160

Code	Range	Resolution	Accuracy	Repeatability	L	B
2711-165	12.7-165mm/0.5-6.5"	0.1mm/0.01"	±0.3mm	0.2mm	85	252
2711-216	12.7-216mm/0.5-8.5"	0.1mm/0.01"	±0.3mm	0.2mm	160	327

DATA OUTPUT

- Resolution: 0.005mm/0.0002"
- Reading in digit and analog
- Display can be rotated by 170°
- Button function: tolerance Go and No-Go display, data preset, max./min. measurement, data holding, inch/metric conversion, absolute/incremental measurement
- CR2032 battery, automatic power off
- Data output
- Optional accessory: wireless transmitter code **7315-30** (receiver is needed) page 5, bluetooth transmitter code **7214-30** page 11, data output cable code **7302-30** page 20

DIGITAL EXTERNAL CALIPER GAUGES



2131-21

Unit: mm

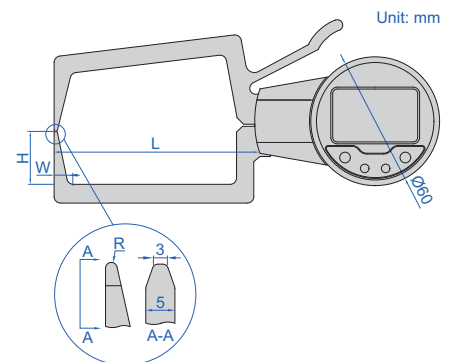
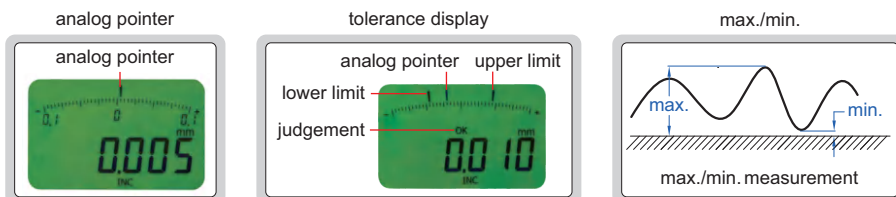

Code	Range	Accuracy	Repeatability	L	H	W	R
2131-21	0-20mm/0-0.8"	±0.03mm	0.01mm	80mm	25mm	6.5mm	R0.5mm
2131-31	10-30mm/0.4-1.2"	±0.03mm	0.01mm	80mm	25mm	6.5mm	R0.5mm
2131-41	20-40mm/0.8-1.6"	±0.03mm	0.01mm	80mm	25mm	6.5mm	R0.5mm
2131-51	30-50mm/1.2-2.0"	±0.03mm	0.01mm	80mm	25mm	6.5mm	R0.5mm
2131-61	40-60mm/1.6-2.4"	±0.03mm	0.01mm	80mm	25mm	6.5mm	R0.5mm

EXTERNAL DIAL CALIPER GAUGES

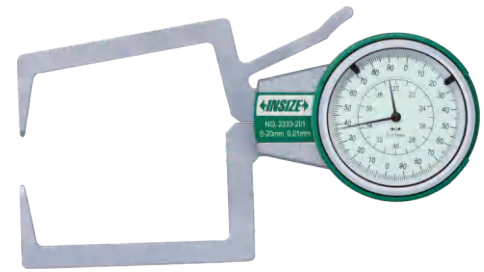
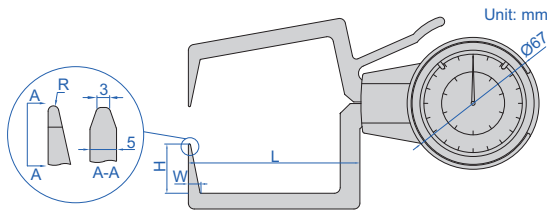

2333-201

Code	Range	Graduation	Accuracy	L	H	W	R
2333-201	0-20mm	0.01mm	±0.03mm	80	25	6.5	R0.5
2333-301	10-30mm	0.01mm	±0.03mm	80	25	6.5	R0.5
2333-401	20-40mm	0.01mm	±0.03mm	80	25	6.5	R0.5
2333-501	30-50mm	0.01mm	±0.03mm	80	25	6.5	R0.5
2333-601	40-60mm	0.01mm	±0.03mm	80	25	6.5	R0.5

DIGITAL EXTERNAL CALIPER GAUGES

DATA OUTPUT

- Carbide measuring tips
- Reading in digit and analog
- With transmission button and signal light
- Display can be rotated by 320°
- Button function: on/off, zero, tolerance Go and No-Go display, data preset, measuring direction change, max./min./TIR measurement, inch/metric conversion, absolute/incremental measurement, data output
- CR2032 battery
- Automatic power off (time is adjustable)
- Data output
- Optional accessory: wireless transmitter code **7315-50M** (receiver is needed) page 6, bluetooth transmitter code **7214-50M** page 12, data output cable code **7302-50M** page 21

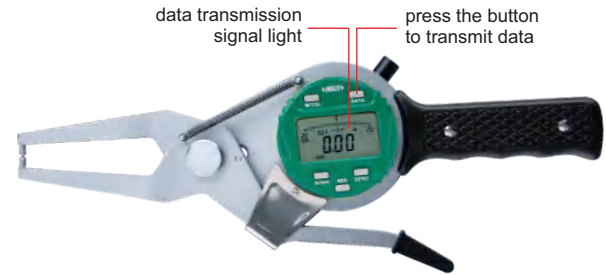
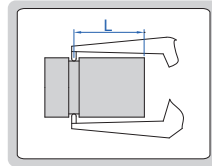

2132-20

Code	Range	Resolution	Accuracy	L
2132-20	0-20mm/0-0.8"	0.01mm/0.0005"	±0.04mm	<60mm
2132-40	20-40mm/0.8-1.6"	0.01mm/0.0005"	±0.04mm	<60mm
2132-60	40-60mm/1.6-2.4"	0.01mm/0.0005"	±0.04mm	<55mm
2132-80	60-80mm/2.4-3.2"	0.01mm/0.0005"	±0.04mm	<55mm
2132-100	80-100mm/3.2-4"	0.01mm/0.0005"	±0.04mm	<55mm

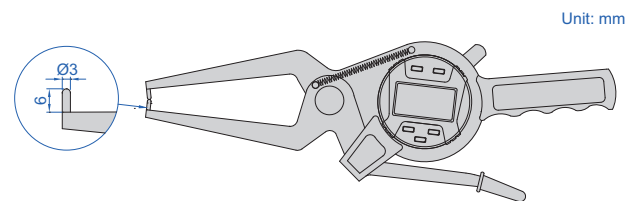

EXTERNAL DIAL CALIPER GAUGES

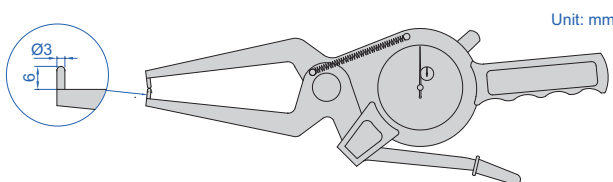

- Carbide measuring tips



2332-20

Code	Range	Graduation	Accuracy	L
2332-20	0-20mm	0.01mm	±0.04mm	<60
2332-40	20-40mm	0.01mm	±0.04mm	<60
2332-60	40-60mm	0.01mm	±0.04mm	<55
2332-80	60-80mm	0.01mm	±0.04mm	<55
2332-100	80-100mm	0.01mm	±0.04mm	<55

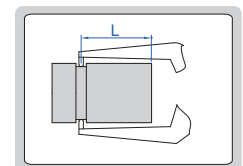



HIGH PRECISION DIGITAL THICKNESS GAUGES

ATTENTION: RECHARGEABLE BATTERY, FOR 12 HOURS CONTINUOUS WORKING

DATA OUTPUT

MEASURING TIPS AND ANVILS CAN BE CUSTOM-MADE

ABSOLUTE ENCODER, THE ORIGINAL DATA REMAINS AFTER POWER OFF



2879-10



2879-30



2879-60

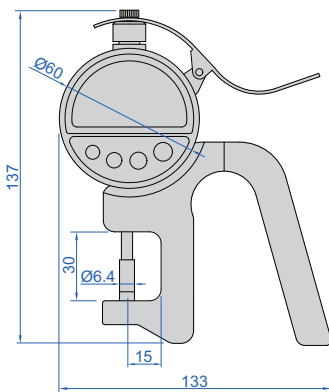

2879-10
2879-101

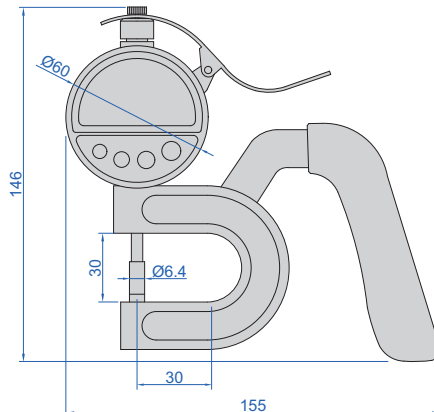

2879-30

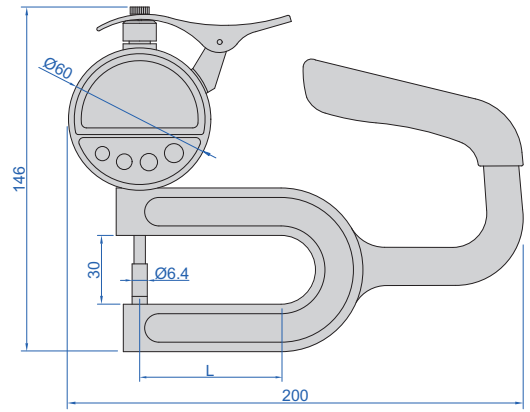

2879-60
2879-100

Unit: mm

- Absolute encoder, the original data remains after power off
- Button function: on/off, zero, tolerance, absolute/incremental measurement, max./min./TIR, data preset, mm/inch, data output, data hold
- Reading in digital and analog
- Power: rechargeable battery, for 12 hours continuous working
- Data output
- Supplied with data output cable (keyboard format)

Code	Range	Resolution	Accuracy	Repeatability	Measuring force	L
2879-10	0-10mm/0-0.4"	0.001mm/0.00005"	±0.002mm	0.001mm	0.5-1N	—
2879-101	0-10mm/0-0.4"	0.0005mm/0.00002"	±0.0015mm	0.0005mm	0.5-1N	—
2879-30	0-10mm/0-0.4"	0.001mm/0.00005"	±0.002mm	0.001mm	0.5-1N	—
2879-60	0-10mm/0-0.4"	0.001mm/0.00005"	±0.003mm	0.001mm	0.5-1N	60mm
2879-100	0-10mm/0-0.4"	0.001mm/0.00005"	±0.004mm	0.001mm	0.5-1N	100mm

SMART DIGITAL THICKNESS GAUGES



2850-10



AUTOMATIC MEASUREMENT OF THE MIN. VALUE, AND THE DATA CAN BE TRANSMITTED AUTOMATICALLY AFTER EACH MEASUREMENT

DATA OUTPUT

LINEAR BALL BEARINGS FOR TEN MILLION TIMES USE

ABSOLUTE ENCODER, THE ORIGINAL DATA REMAINS AFTER POWER OFF

ATTENTION: RECHARGEABLE BATTERY, FOR 24 HOURS CONTINUOUS WORKING

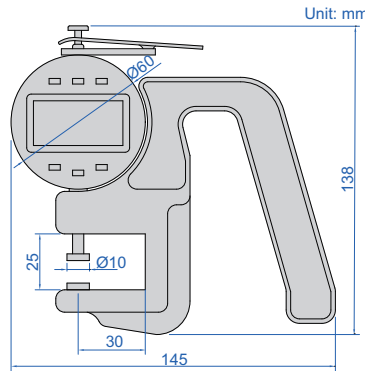

- Linear ball bearings for ten million times use
- Absolute encoder, the original data remains after power off
- Adjustable resolution: 0.0005mm/0.00002"
 - 0.001mm/0.00005"
 - 0.01mm/0.0005"
- Ceramic spindle tip and anvil
- Reading in digital and analog
- Data output
- Automatic measurement of the min. value, and the data can be transmitted automatically after each measurement
- Button function: data output, tolerance, data preset, data hold, measuring direction change, power off time, on/off, mm/inch, adjust resolution
- Power: rechargeable battery, for 24 hours continuous working

With data interface

Optional accessory:
 wireless transmitter code **7315-60** (receiver is needed) page 7
 data output cable (keyboard format) code **7302-60** page 21

Code	Range	Accuracy
2850-10	10mm/0.4"	±3µm

wireless receiver
2134-R1, 2134-R2 (optional)

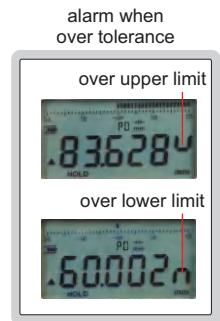
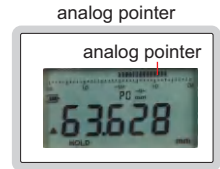

Built-in wireless

Optional accessory:
 wireless receiver (keyboard format, connect up to 15 digital indicators), code **2134-R1**
 wireless receiver (serial port format, connect up to 15 digital indicators), code **2134-R2**

Code	Range	Accuracy
2850-10WL	10mm/0.4"	±3µm

DIGITAL THICKNESS GAUGES (WITH BASE)

- Button function: on/off, inch/mm, zero, data preset, change measuring direction, absolute/incremental measurement
- Keep preset data in memory after restart
- CR2032 battery, automatic power off (time is adjustable)
- Data output
- Optional accessory:
 wireless transmitter code **7315-50M** (receiver is needed) page 6,
 bluetooth transmitter code **7214-50M** page 12,
 data output cable code **7302-50M** page 21



2673-10

DATA OUTPUT

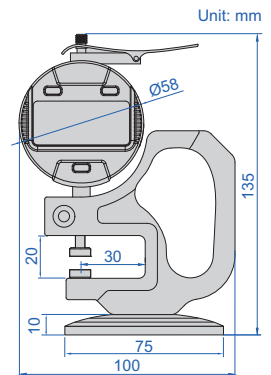

Code	Range	Resolution	Accuracy	Type
2673-10	0-10mm/0-0.4"	0.01mm/0.0005"	±0.02mm	A
2673-101	0-10mm/0-0.4"	0.001mm/0.00005"	±0.005mm	A
2673-10B	0-10mm/0-0.4"	0.01mm/0.0005"	±0.02mm	B
2673-101B	0-10mm/0-0.4"	0.001mm/0.00005"	±0.005mm	B

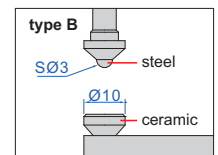
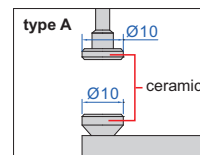

POPULAR MODEL

DATA OUTPUT

DIGITAL THICKNESS GAUGES

- Button function: on/off, inch/mm, zero, data preset, change measuring direction, absolute/incremental measurement
- Keep preset data in memory after restart
- CR2032 battery, automatic power off (time is adjustable)
- Data output
- Optional accessory:
wireless transmitter code **7315-50M** (receiver is needed) page 6,
bluetooth transmitter code **7214-50M** page 12,
data output cable code **7302-50M** page 21

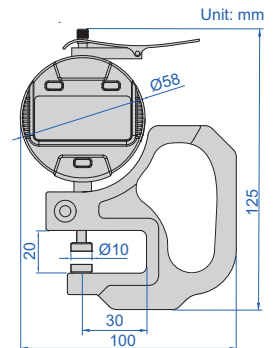

2871-101

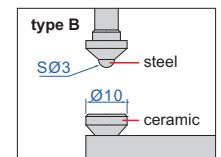
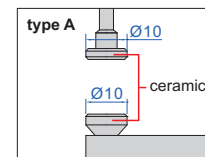

Code	Range	Resolution	Accuracy	Type
2871-10	0-10mm/0-0.4"	0.01mm/0.0005"	± 0.02 mm	A
2871-101	0-10mm/0-0.4"	0.001mm/0.00005"	± 0.005 mm	A
2871-10B	0-10mm/0-0.4"	0.01mm/0.0005"	± 0.02 mm	B
2871-101B	0-10mm/0-0.4"	0.001mm/0.00005"	± 0.005 mm	B

THICKNESS GAUGES

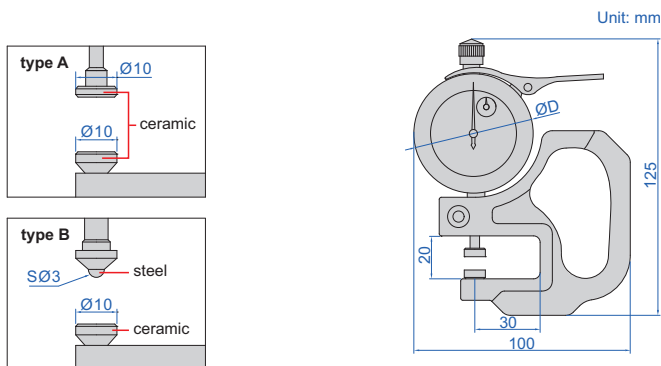

2364-10



2364-1

Code	Range	Graduation	Accuracy	Type	$\varnothing D$
2364-10	0-10mm	0.01mm	± 0.02 mm	A	58mm
2364-10B	0-10mm	0.01mm	± 0.02 mm	B	58mm
2364-1	0-1mm	0.001mm	± 0.005 mm	A	56mm

THICKNESS GAUGES

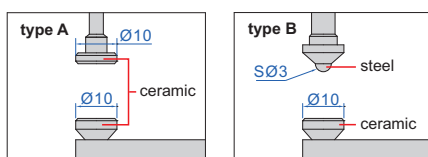

2366-30

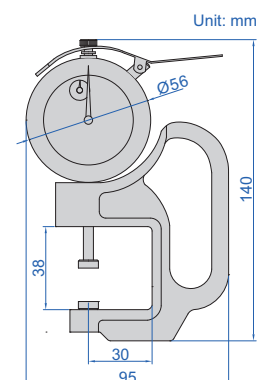

Code	Range	Graduation	Accuracy	Type
2366-30	0-30mm	0.01mm	± 0.035 mm	A
2366-30B	0-30mm	0.01mm	± 0.035 mm	B

DIGITAL THICKNESS GAUGES (WITH BASE)

DATA
OUTPUT

measuring tips
and anvils can be
custom-made

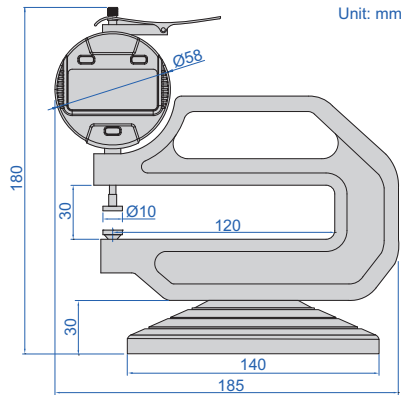

2674-10

- Ceramic spindle tip and anvil
- Buttons: on/off, inch/mm, zero, data preset, change measuring direction, absolute/incremental measurement
- Keep preset data in memory after restart
- Battery CR2032, automatic power off (time is adjustable)
- Data output
- Optional accessory:
wireless transmitter code **7315-50M** (receiver is needed) page 6,
bluetooth transmitter code **7214-50M** page 12,
data output cable code **7302-50M** page 21

Code	Range	Resolution	Accuracy
2674-10	0-10mm/0-0.4"	0.01mm/0.0005"	±0.02mm
2674-101	0-10mm/0-0.4"	0.001mm/0.00005"	±0.01mm

11

DIGITAL THICKNESS GAUGES

DATA
OUTPUT

measuring tips
and anvils can be
custom-made

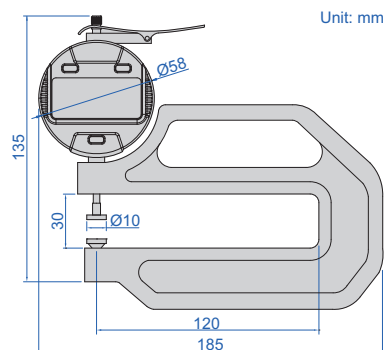

2872-10

- Ceramic spindle tip and anvil
- Buttons: on/off, inch/mm, zero, data preset, change measuring direction, absolute/incremental measurement
- Keep preset data in memory after restart
- Battery CR2032, automatic power off (time is adjustable)
- Data output
- Optional accessory:
wireless transmitter code **7315-50M** (receiver is needed) page 6,
bluetooth transmitter code **7214-50M** page 12,
data output cable code **7302-50M** page 21

Code	Range	Resolution	Accuracy
2872-10	0-10mm/0-0.4"	0.01mm/0.0005"	±0.02mm
2872-101	0-10mm/0-0.4"	0.001mm/0.00005"	±0.01mm

THICKNESS GAUGES

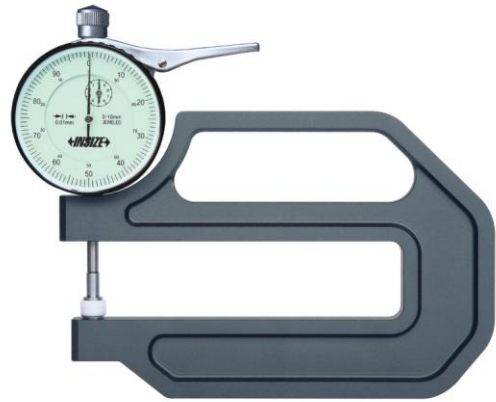
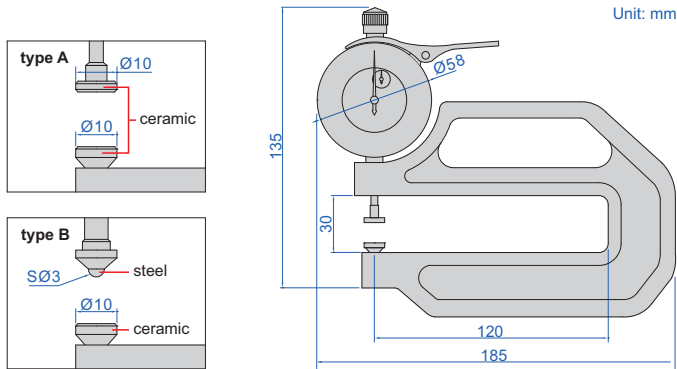

2365-10

Code	Range	Graduation	Accuracy	Type
2365-10	0-10mm	0.01mm	±0.02mm	A
2365-20	0-20mm	0.01mm	±0.03mm	A
2365-10B	0-10mm	0.01mm	±0.02mm	B
2365-20B	0-20mm	0.01mm	±0.03mm	B

measuring tips and anvils can be custom-made



SUITABLE FOR JEWELLERY

THICKNESS GAUGE



2361-10

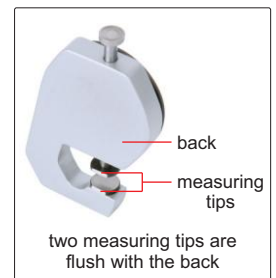
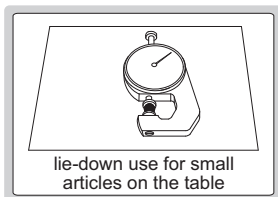
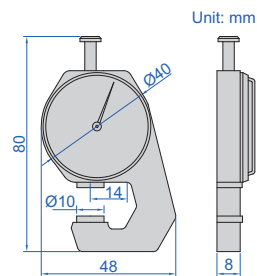

Code	Range	Graduation	Accuracy
2361-10	0-10mm	0.1mm	±0.05mm

THICKNESS GAUGE

- Stainless steel spindle tip and anvil

Code	Range	Graduation	Accuracy
2363-10	0-10mm	0.01mm	±0.03mm



2363-10

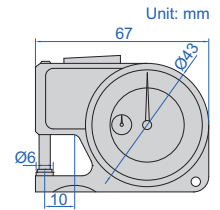

DIGITAL ROLLER THICKNESS GAUGES

DATA OUTPUT



2877-4



2877-10

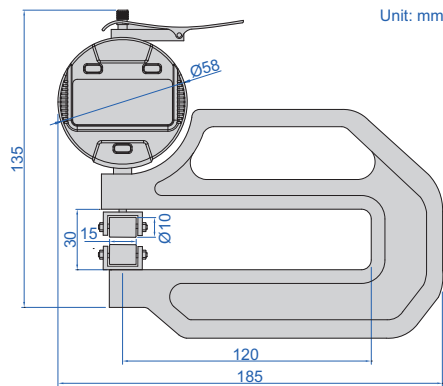

2877-4/2877-41

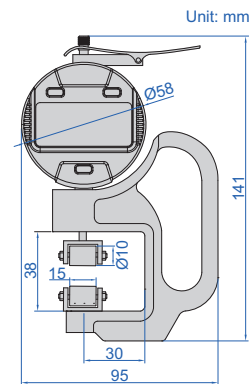

2877-10/2877-101

- Buttons: on/off, inch/mm, zero, data preset, change measuring direction, absolute/incremental measurement
- Keep preset data in memory after restart
- Battery CR2032, automatic power off (time is adjustable)
- Data output
- Optional accessory:
 - wireless transmitter code **7315-50M** (receiver is needed) page 6,
 - bluetooth transmitter code **7214-50M** page 12,
 - data output cable code **7302-50M** page 21

Code	Range	Resolution	Accuracy
2877-4	0-3.5mm/0-0.14"	0.01mm/0.0005"	±0.02mm
2877-41	0-3.5mm/0-0.14"	0.001mm/0.00005"	±0.01mm
2877-10	0-10mm/0-0.4"	0.01mm/0.0005"	±0.02mm
2877-101	0-10mm/0-0.4"	0.001mm/0.00005"	±0.01mm

THICKNESS GAUGES

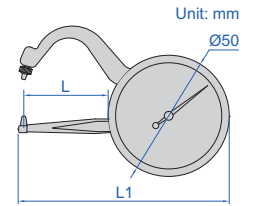
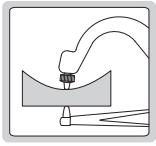

2862-101

Code	Range	Graduation	Accuracy	L	L1
2862-101	0-10mm	0.05mm	±0.1mm	35mm	85mm
2862-102	0-10mm	0.05mm	±0.1mm	60mm	110mm

THICKNESS GAUGE

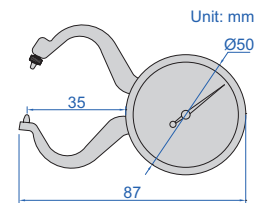
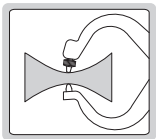

2863-10

Code	Range	Graduation	Accuracy
2863-10	0-10mm	0.05mm	±0.1mm

THICKNESS GAUGE WITH POINTED TIPS

- Pointed tips fit into small grooves and recesses

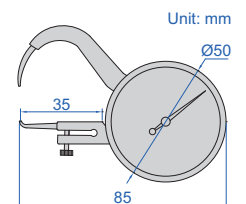
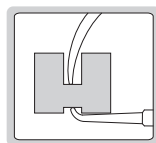

2866-10

Code	Range	Graduation	Accuracy
2866-10	0-10mm	0.05mm	±0.1mm

THICKNESS GAUGE

- Main body is made of hard plastic



2870-10

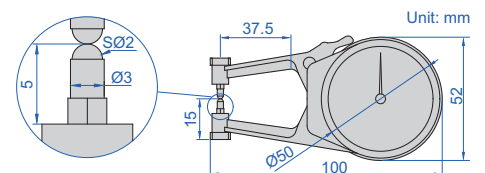

Code	Range	Graduation	Accuracy
2870-10	0-10mm	0.1mm	±0.1mm

DIGITAL THICKNESS GAUGE



2710-25

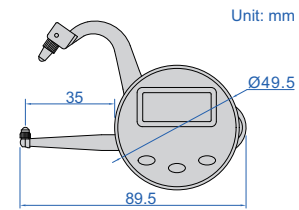

- Resolution: 0.01mm, 0.001", 1/64"
- Buttons: on/off, zero, unit (mm/in/fraction), data hold
- Battery CR2032, automatic power off

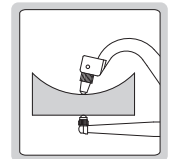

Code	Range	Accuracy	Repeatability
2710-25	0-25.4mm/0-1"	0.05mm	0.02mm

DIGITAL GEOMEMBRANE THICKNESS GAUGE

DATA OUTPUT

11



2259-10



- Measure thickness of geomembranes
- Button function: on/off, inch/mm, zero, data preset, change measuring direction, absolute/incremental measurement
- CR2032 battery, automatic power off (time is adjustable)
- Supplied with dust cover
- Optional accessory:
 - wireless transmitter code **7315-50M** (receiver is needed) page 6,
 - bluetooth transmitter code **7214-50M** page 12,
 - data output cable code **7302-40M** page 21

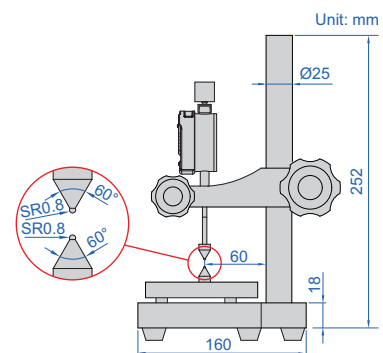

Code	Range	Resolution	Accuracy	Pressure
2259-10	12.7mm/0.5"	0.001mm/0.00005"	5µm	0.56±0.05N

DATA
OUTPUT



DIGITAL RUBBER THICKNESS GAUGES



2878-6B

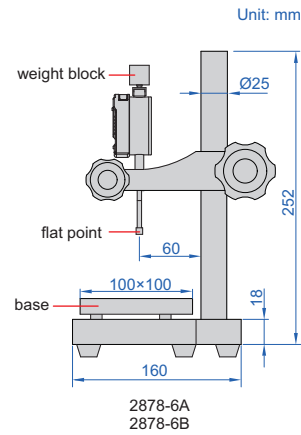

2878-71B

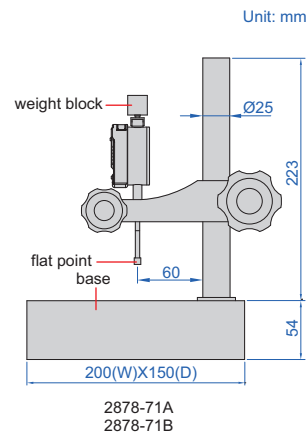

- Measure thickness of vulcanized rubber and plastic products
- Button function: on/off, inch/mm, zero, data preset, change measuring direction, absolute/incremental measurement
- CR2032 battery, automatic power off (time is adjustable)
- Supplied with dust cover
- Optional accessory:
 - wireless transmitter code **7315-50M** (receiver is needed) page 6,
 - bluetooth transmitter code **7214-50M** page 12,
 - data output cable code **7302-40M** page 21,
 - flat points, weight blocks

Code	Range	Resolution	Accuracy	Flat point diameter	Pressure	Base
2878-6A	12.7mm/0.5"	0.01mm/0.0005"	20µm	6mm	22kPa±5kPa	ceramic, plain, flatness 1.5µm
2878-6B	12.7mm/0.5"	0.001mm/0.00005"	5µm	6mm	22kPa±5kPa	ceramic, plain, flatness 1.5µm
2878-71A	12.7mm/0.5"	0.01mm/0.0005"	20µm	6mm	22kPa±5kPa	granite, plain, flatness 2.5µm
2878-71B	12.7mm/0.5"	0.001mm/0.00005"	5µm	6mm	22kPa±5kPa	granite, plain, flatness 2.5µm

Flat points and weight blocks (optional)

Flat point	Flat point code	Pressure				
		10kPa±2kPa weight block code	22kPa±5kPa weight block code	20kPa±3kPa weight block code	70kPa±5kPa weight block code	1.6kPa±0.1kPa weight block code
Ø4mm	2878-P4	—	2878-W4B	—	—	—
Ø5mm	2878-P5	2878-W5A	2878-W5B	2878-W5C	2878-W5D	—
Ø6mm	2878-P6	2878-W6A	2878-W6B	—	—	—
Ø8mm	2878-P8	2878-W8A	2878-W8B	—	—	—
Ø10mm	2878-P10	2878-W10A	2878-W10B	2878-W10C	—	—
Ø25mm	2878-P25	—	—	—	—	2878-W25E
1×4mm (rectangle)	2878-P14	—	—	—	2878-W14D	—

DIGITAL RUBBER THICKNESS GAUGES

DATA
OUTPUT



2263-6B

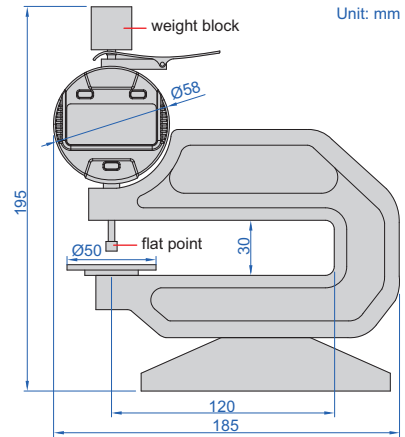

11

- Measure thickness of vulcanized rubber and plastic products
- Button function: on/off, inch/mm, zero, data preset, change measuring direction, absolute/incremental measurement
- Keep preset data in memory after restart
- CR2032 battery, automatic power off (time is adjustable)
- Data output
- Optional accessory:
 - wireless transmitter code **7315-50M** (receiver is needed) page 6,
 - bluetooth transmitter code **7214-50M** page 12,
 - data output cable code **7302-50M** page 21,
 - flat points, weight blocks

Code	Range	Resolution	Accuracy	Flat point diameter	Pressure
2263-6A	0-10mm/0-0.4"	0.01mm/0.0005"	20µm	6mm	22kPa±5kPa
2263-6B	0-10mm/0-0.4"	0.001mm/0.00005"	5µm	6mm	22kPa±5kPa

Flat points and weight blocks (optional)

Flat point	Flat point code	Pressure				
		10kPa±2kPa	22kPa±5kPa	20kPa±3kPa	70kPa±5kPa	1.6kPa±0.1kPa
		weight block code	weight block code	weight block code	weight block code	weight block code
Ø4mm	2878-P4	—	2878-W4B	—	—	—
Ø5mm	2878-P5	2878-W5A	2878-W5B	2878-W5C	2878-W5D	—
Ø6mm	2878-P6	2878-W6A	2878-W6B	—	—	—
Ø8mm	2878-P8	2878-W8A	2878-W8B	—	—	—
Ø10mm	2878-P10	2878-W10A	2878-W10B	2878-W10C	—	—
Ø25mm	2878-P25	—	—	—	—	2878-W25E
1×4mm (rectangle)	2878-P14	—	—	—	2878-W14D	—

DATA
OUTPUT



DIGITAL LEATHER THICKNESS GAUGES



2262-10

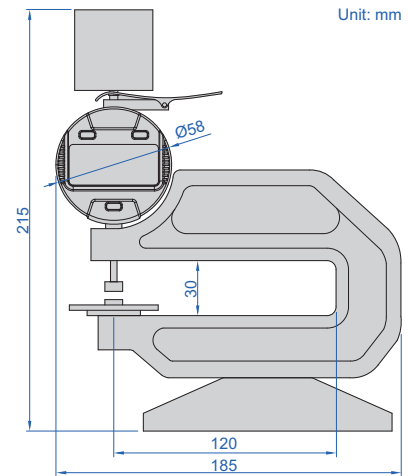

- Measure thickness of leather
- Buttons: on/off, inch/mm, zero, data preset, change measuring direction, absolute/incremental measurement
- Keep preset data in memory after restart
- Battery CR2032, automatic power off (time is adjustable)
- Data output
- Optional accessory:
 - wireless transmitter code **7315-50M** (receiver is needed) page 6,
 - bluetooth transmitter code **7214-50M** page 12,
 - data output cable code **7302-50M** page 21

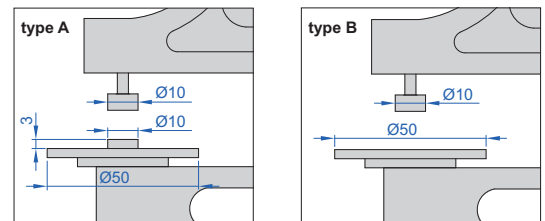

Code	Range	Resolution	Accuracy	Type
2262-10	0-10mm/0-0.4"	0.01mm/0.0005"	±0.02mm	A
2262-10B	0-10mm/0-0.4"	0.01mm/0.0005"	±0.02mm	B

TUBE THICKNESS GAUGE

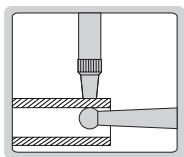

- Measure tube wall thickness



2367-10A

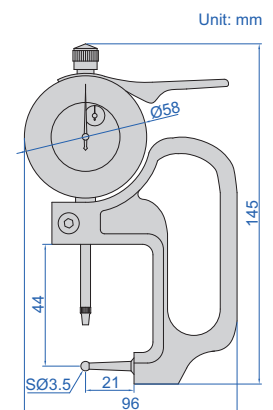

Code	Range	Graduation	Accuracy
2367-10A	0-10mm	0.01mm	±0.02mm

DIGITAL TUBE THICKNESS GAUGES

DATA
OUTPUT



2876-10

Unit: mm

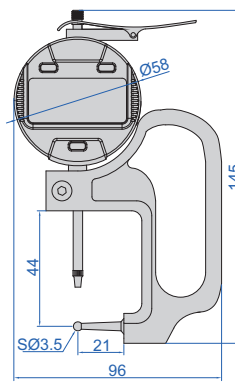

- Buttons: on/off, inch/mm, zero, data preset, change measuring direction, absolute/incremental measurement
- Keep preset data in memory after restart
- Battery CR2032, automatic power off (time is adjustable)
- Data output
- Optional accessory:
wireless transmitter code **7315-50M** (receiver is needed) page 6,
bluetooth transmitter code **7214-50M** page 12,
data output cable code **7302-50M** page 21

Code	Range	Resolution	Accuracy
2876-10	0-10mm/0-0.4"	0.01mm/0.0005"	±0.02mm
2876-101	0-10mm/0-0.4"	0.001mm/0.00005"	±0.005mm

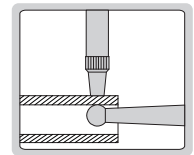

DIGITAL TUBE THICKNESS GAUGES

DATA
OUTPUT



2873-10

Unit: mm

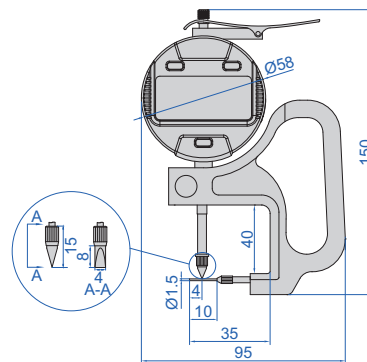

- Buttons: on/off, inch/mm, zero, data preset, change measuring direction, absolute/incremental measurement
- Keep preset data in memory after restart
- Battery CR2032, automatic power off (time is adjustable)
- Data output
- Optional accessory:
wireless transmitter code **7315-50M** (receiver is needed) page 6,
bluetooth transmitter code **7214-50M** page 12,
data output cable code **7302-50M** page 21

Code	Range	Resolution	Accuracy
2873-10	0-10mm/0-0.4"	0.01mm/0.0005"	±0.02mm
2873-101	0-10mm/0-0.4"	0.001mm/0.00005"	±0.005mm

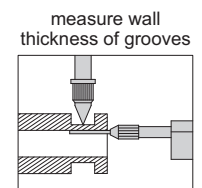

DATA
OUTPUT

DIGITAL TUBE THICKNESS GAUGES

- Buttons: on/off, inch/mm, zero, data preset, change measuring direction, absolute/incremental measurement
- Keep preset data in memory after restart
- Battery CR2032, automatic power off (time is adjustable)
- Data output
- Optional accessory:
wireless transmitter code **7315-50M** (receiver is needed) page 6,
bluetooth transmitter code **7214-50M** page 12,
data output cable code **7302-50M** page 21

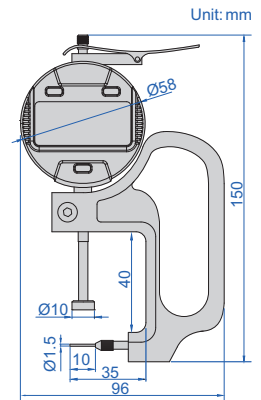

2859-101

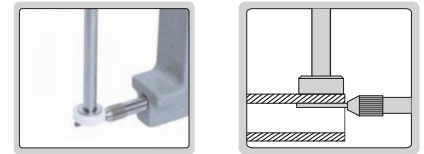

Code	Range	Resolution	Accuracy
2859-10	0-10mm/0-0.4"	0.01mm/0.0005"	±0.02mm
2859-101	0-10mm/0-0.4"	0.001mm/0.00005"	±0.005mm

THREAD/LEAD SCREW PITCH DIAMETER SNAP GAUGES

application



BALL TIP DIAMETER
CAN BE CUSTOMIZED



digital indicator
is optional



- Measure the pitch diameter of lead screw and external thread
- Ball tip diameter can be customized according to workpieces.
Diameter of trapezoidal screw or external thread ball tips:
 $\varnothing D = 0.5 \times \text{pitch} / \cos(\text{thread angle } \alpha/2)$.
Ball tips diameter $\varnothing D$ of ball screw is corresponding steel ball specification
- Probe retracting range: 3mm, measuring force: 20N
- Repeatability: 2 μ m
- Optional accessory: 0.001mm digital/dial indicators

2165-40

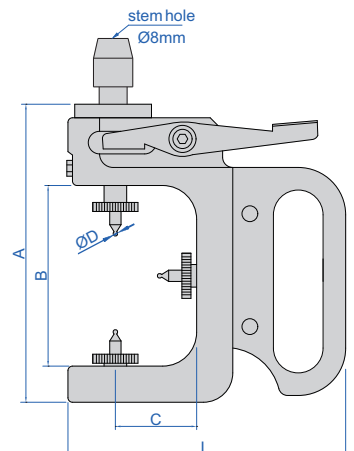

(mm)

Code	Range	Accuracy	A	B	C	L
2165-20	3-20mm	±5 μ m	116	60	27	113
2165-40	20-40mm	±5 μ m	132	80	37	123
2165-60	40-60mm	±5 μ m	152	138	46	100
2165-80	60-80mm	±5 μ m	172	156	59	121
2165-100	80-100mm	±5 μ m	192	170	68	140

DIAL SNAP GAUGES

INSIZE PLUS
MADE IN EUROPE

- Quick Go/No-Go measurement for mass production
- Anvil retracting stroke: 2.5mm
- Dial indicator: measuring range ± 0.07 mm, graduation $1\mu\text{m}$, accuracy $\pm 1\mu\text{m}$
- Constant measuring force over the whole range: 8.5N
- Carbide measuring faces
- IP54 dust/waterproof
- Zero position of dial indicator is adjustable and can be locked (supplied with locking wrench)
- Adjustable platform height

Code	Range	L	a	b
3335-25	0-25mm	35mm	191mm	<15mm
3335-50	25-50mm	60mm	215mm	<25mm
3335-75	50-75mm	84mm	239mm	<37.5mm
3335-100	75-100mm	110mm	265mm	<50mm

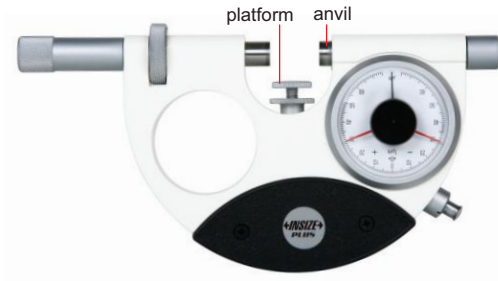

3335-25

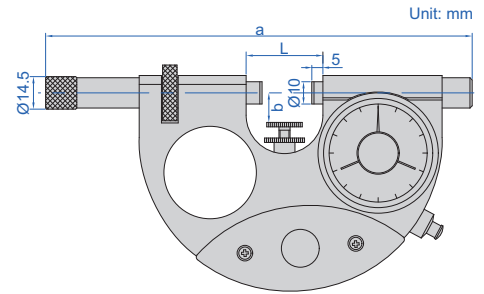
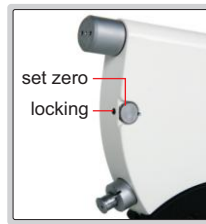

IP54
WATERPROOF



DIAL SNAP GAUGES

- Quick measurement for mass production
- Dial indicator: range ± 0.04 mm, graduation 0.001 mm, accuracy 0.001 mm
- IP54 dust/waterproof
- Measuring force: 5-10N
- Carbide measuring faces
- Optional accessory: gauge blocks grade 0 (4101-A series), for zero setting

Code	Range	L	D
3334-25	0-25mm	28.5mm	25mm
3334-50	25-50mm	53.5mm	35mm
3334-75	50-75mm	78.5mm	47.5mm
3334-100	75-100mm	103.5mm	60mm



3334-25

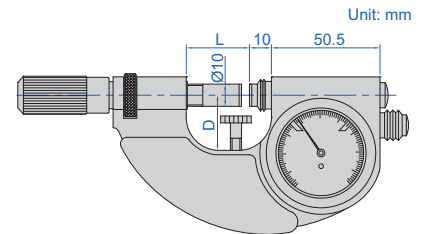

ATTENTION: SETTING STANDARDS ARE NOT INCLUDED

IP54
WATERPROOF

DIAL SNAP GAUGES

- Quick measurement for mass production
- Anvil retracting stroke: 3mm
- Measuring force: 6-9N
- Carbide measuring faces
- Optional accessory: dial indicators (graduation 0.01 mm), digital indicators (resolution 0.01 mm/ 0.0005 "")

Code	Range	A	B
2184-25W	0-25mm	34mm	18mm
2184-50W	0-50mm	62mm	32mm
2184-100W	50-100mm	112mm	62mm
2184-150W	100-150mm	162mm	85mm
2184-200W	150-200mm	212mm	110mm



2184-50W

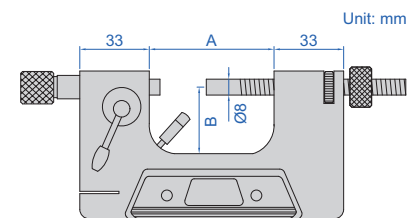

ATTENTION: NOT SUITABLE FOR 0.001MM DIAL INDICATORS



QUICK AND ACCURATE MEASUREMENT OF CYLINDRICAL WORKPIECES

DIAL SNAP GAUGES



- Left anvil retracting stroke: 2mm
- Measuring force: 6-8N
- Flatness of anvil: 1.5µm
- Repeatability: 1µm
- Carbide measuring faces for anvils
- Front edges of anvils are chamfered for easy workpiece insertion
- Optional accessory: dial indicators and digital indicators (reading 0.001mm or 0.01mm)



digital indicator is optional

2186-25

application



Code	Range	Parallelism of measuring faces	A	B	C
2186-25 *	0-25mm	4µm	42	11-18	20
2186-50 *	25-50mm	4µm	69	11-32	41
2186-75 *	50-75mm	5µm	94	17-41	51
2186-100 *	75-100mm	6µm	119	31-55	65
2186-125 *	100-125mm	6µm	144	42-70	75
2186-150 *	125-150mm	8µm	169	55-82	90
2186-175 *	150-175mm	8µm	194	68-95	100
2186-200 *	175-200mm	10µm	219	85-110	115
2186-225 *	200-225mm	10µm	244	95-120	130
2186-250 *	225-250mm	10µm	269	110-135	145
2186-275 *	250-275mm	12µm	294	120-150	160
2186-300 *	275-300mm	12µm	319	128-160	170

(mm)

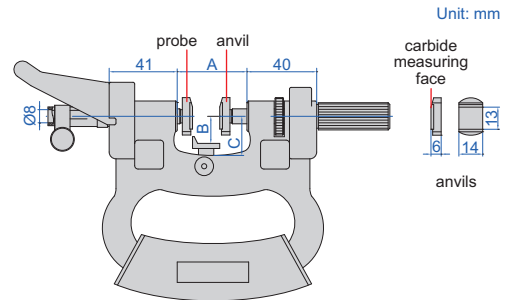

* Supplied with manufacturer inspection certificate

ATTENTION: NO DATA OUTPUT

DIGITAL SNAP GAUGE



2166-12

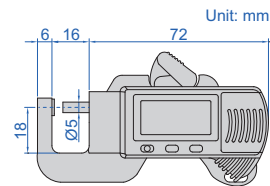

Code	Range	Resolution	Accuracy
2166-12	0-12mm/0-0.5"	0.01mm/0.0005"	±0.03mm

ATTENTION: NO DATA OUTPUT

DIGITAL SNAP GAUGE



2167-25

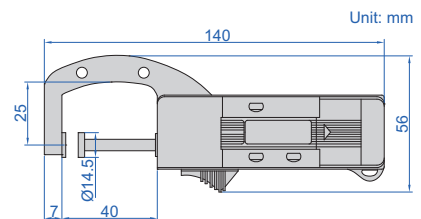

Code	Range	Resolution	Accuracy
2167-25	0-25mm/0-1"	0.01mm/0.0005"	±0.03mm

DIGITAL SNAP GAUGE

ATTENTION: NO DATA OUTPUT



2163-25

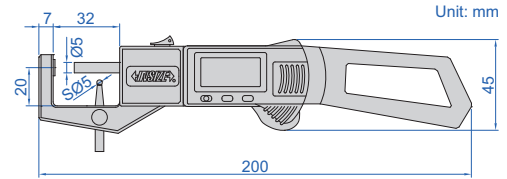

- Resolution: 0.01mm/0.0005"
- Accuracy: $\pm 0.04\text{mm}$
- For thickness and tube wall thickness measurement

Code	Thickness range	Tube wall thickness range
2163-25	0-25mm/0-1"	0-2mm/0.08"

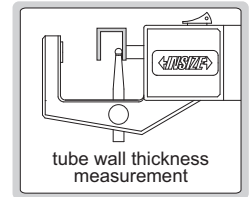
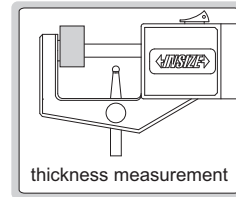

DIGITAL SNAP GAUGES

DATA OUTPUT



1163-50A

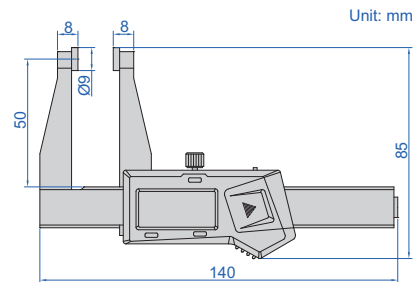

With data interface (optional data output cable: code 7315-25 receiver is needed page 5, 7214-25 page 11, 7302-21 page 20)

Code	Range	Resolution	Accuracy
1163-50A	0-50mm/0-2"	0.01mm/0.0005"	$\pm 0.03\text{mm}$

Built-in wireless (receiver code 7315-2/3/6/7/8/9 is needed)

Code	Range	Resolution	Accuracy
1163-50AWL	0-50mm/0-2"	0.01mm/0.0005"	$\pm 0.03\text{mm}$

- Non waterproof
- Buttons: on/off, zero, mm/inch
- Automatic power off, move the digital unit to turn on power
- Battery CR2032
- Made of stainless steel

DIGITAL 3-PURPOSE SNAP GAUGE

ATTENTION: NO DATA OUTPUT

SUITABLE FOR JEWELLERY



2164-25A

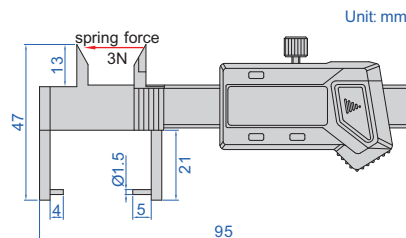

Code	Range	Resolution	Accuracy
2164-25A	0-25mm/0-1"	0.01mm/0.0005"	$\pm 0.03\text{mm}$

- Non waterproof
- Buttons: zero, mm/inch, on/off
- Battery LR44
- Made of stainless steel

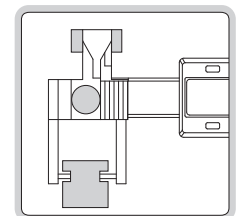

DATA
OUTPUT

STEP AND GAP GAUGES



2168-12

- Non waterproof
- Measure step height and gap width
- Resolution: 0.01mm/0.0005"
- Buttons: on/off, set, mm/inch, preset (+, -)
- Automatic power off, move the digital unit to turn on power
- Battery CR2032
- Made of stainless steel
- Supplied with zero setting block

zero setting block
(included)



With data interface (optional data output cable:
code 7315-25 receiver is needed page 5,
7214-25 page 11, 7302-21 page 20)

Code	Range	Accuracy
2168-12	0-12.7mm/0-0.5"	±0.03mm

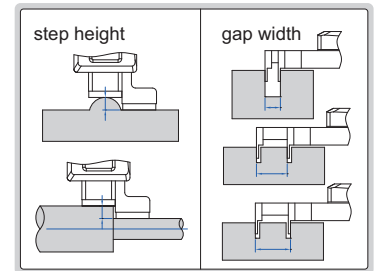
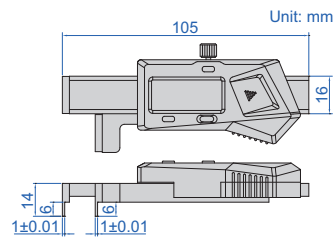

Built-in wireless
(receiver code 7315-2/3/6/7/8/9 is needed)

Code	Range	Accuracy
2168-12WL	0-12.7mm/0-0.5"	±0.03mm

11

MINI VERNIER HEIGHT GAUGE

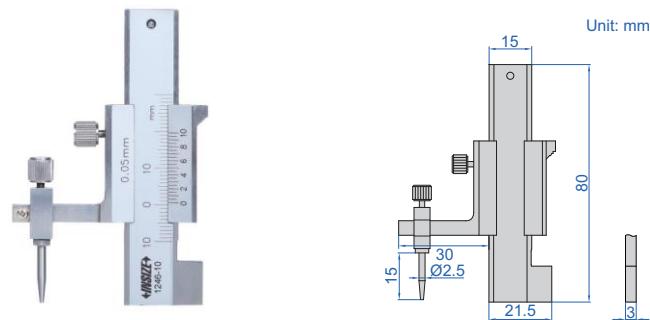

1246-10

- Measure height difference of two surfaces
- Graduation: 0.05mm
- Made of stainless steel
- Satin chrome plated reading surface

Code	Range	Accuracy
1246-10	0~±10mm	±0.05mm

application

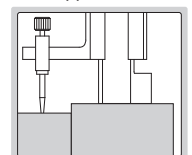

MINI DIGITAL HEIGHT GAUGES

DATA OUTPUT

application of
1146-20A/1146-20AWL

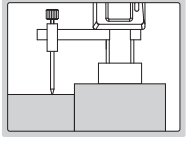

application of
1146-20B/1146-20BWL

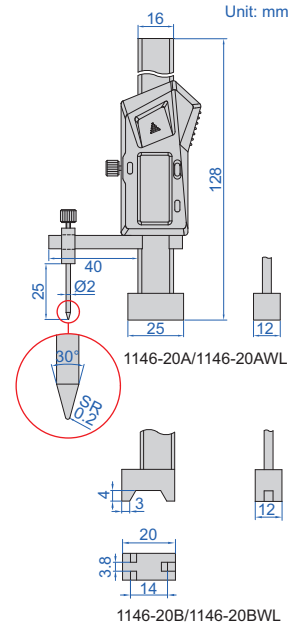
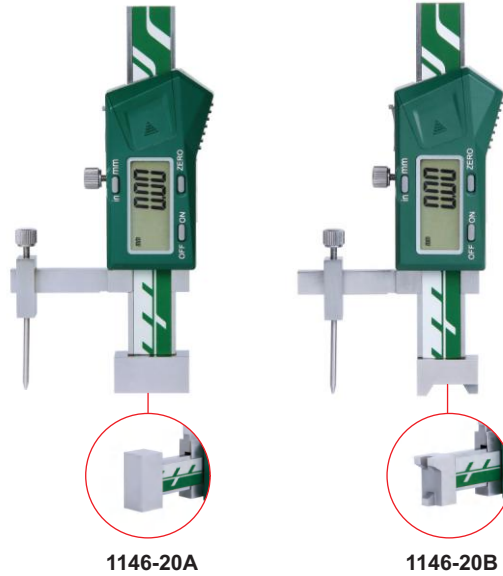
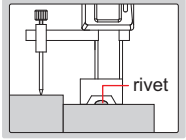

- Non waterproof
- Measure height difference of two surfaces (1146-20B, 1146-20BWL suitable for surfaces with barrier, such as rivet)
- Resolution: 0.01mm/0.0005"
- Buttons: on/off, zero, mm/inch
- Automatic power off, move the digital unit to turn on power
- Battery CR2032
- Made of stainless steel

With data interface (optional data output cable: code 7315-25 receiver is needed page 5, 7214-25 page 11, 7302-21 page 20)

Built-in wireless (receiver code 7315-2/3/6/7/8/9 is needed)

Code	Range	Accuracy
1146-20A	0~±20mm/0~±0.8"	±0.02mm
1146-20B	0~±20mm/0~±0.8"	±0.02mm

Code	Range	Accuracy
1146-20AWL	0~±20mm/0~±0.8"	±0.02mm
1146-20BWL	0~±20mm/0~±0.8"	±0.02mm

11

DIAL HEIGHT GAUGES

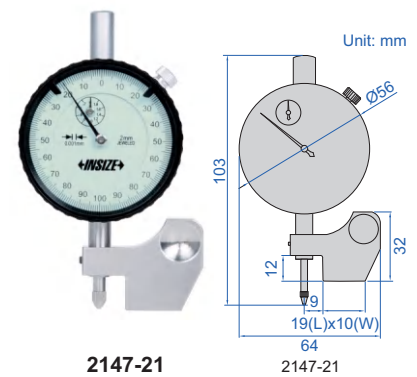
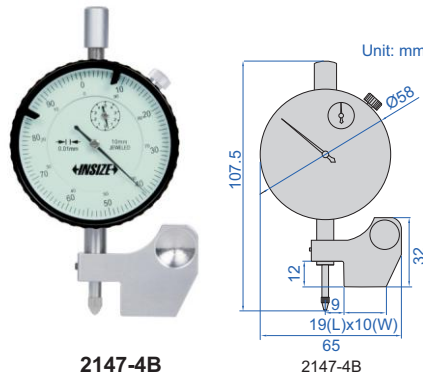
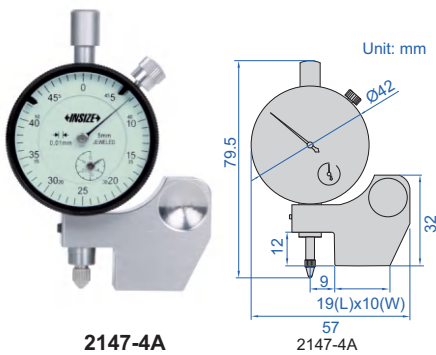

- Measure height difference of two surfaces

Code	Range	Dial indicator stroke	Dial indicator graduation	Accuracy
2147-4A	0~±5mm (adjustable)	5mm	0.01mm	±0.014mm
2147-4B	0~±5mm	10mm	0.01mm	±0.017mm
2147-21	0~±2mm (adjustable)	2mm	0.001mm	±0.006mm

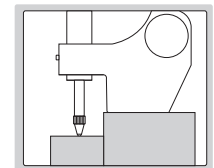

DATA
OUTPUT

DIGITAL HEIGHT GAUGES



2146-4A

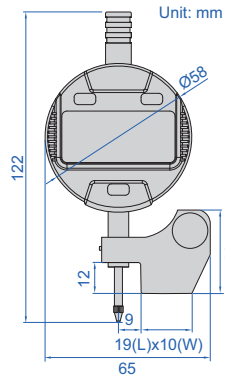

2146-4A
2146-41A



2146-4B

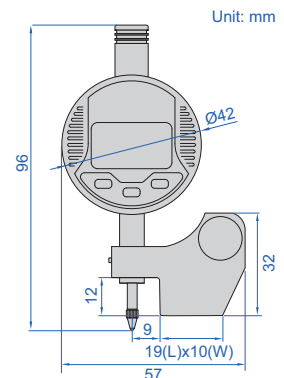

2146-4B
2146-41B

- Measure height difference of two surfaces
- Button function: on/off, inch/mm, zero, data preset, change measuring direction, absolute/incremental measurement
- Keep preset data in memory after restart
- CR2032 battery, automatic power off (time is adjustable)
- Data output
- Optional accessory:
 - wireless transmitter code **7315-50M** (receiver is needed) page 6,
 - bluetooth transmitter code **7214-50M** page 12,
 - data output cable code **7302-40M** page 21

measure sunked step

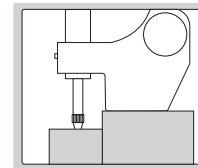

measure raised step

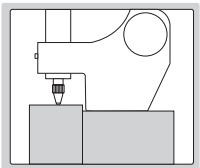

Code	Range (adjustable)	Digital indicator stroke	Digital indicator resolution	Accuracy
2146-4A	0~4mm/0~0.16" (sunked)	12.7mm/0.5"	0.01mm/0.0005"	±0.02mm
2146-41A	0~12.7mm/0~0.5" (raised)	12.7mm/0.5"	0.001mm/0.00005"	±0.005mm
2146-4B	0~4mm/0~0.16" (sunked)	5mm/0.2"	0.01mm/0.0005"	±0.02mm
2146-41B	0~5mm/0~0.2" (raised)	5mm/0.2"	0.001mm/0.00005"	±0.005mm

11

CRANKSHAFT TESTERS

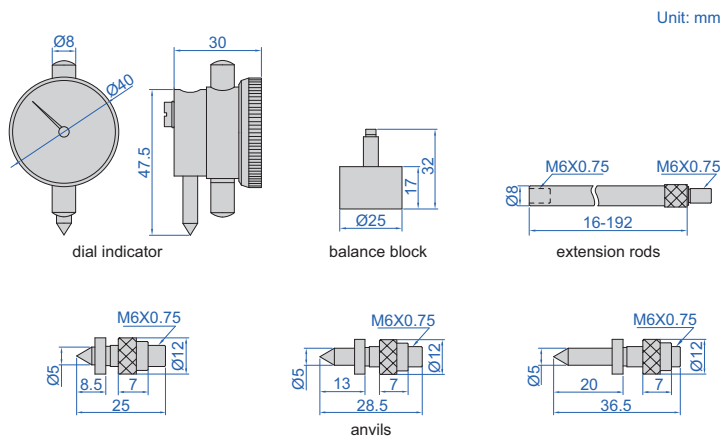

2841-500

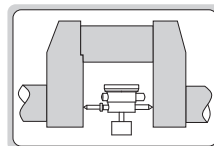

- To test crankshaft deflection
- The balance block is mounted on the back of dial indicator to keep the dial indicator facing up

Code	Range	Dial indicator range	Graduation	Extension rods	Accuracy
2841-300	60-300mm	3mm	0.01mm	16mm, 32mm, 64mm, 128mm	±0.02mm
2841-500	60-500mm	3mm	0.01mm	16mm, 32mm, 64mm, 96mm, 128mm, 192mm	±0.02mm

PERPENDICULARITY COMPARISON GAUGE

CUSTOMIZED ACCORDING TO WORKPIECES

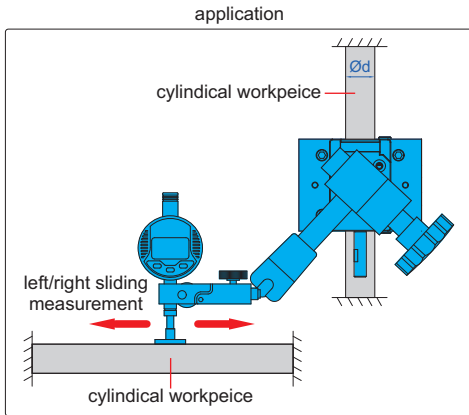

- Measurement perpendicularity between two cylinders
- Optional accessory: measurement software (code 7377)
wireless transmission code 7213-56 (receiver is needed) page 13

Code	Digital indicator stroke	Digital indicator resolution	Perpendicularity	Left/right slide stroke	Cylindrical workpiece diameter $\varnothing d$
2253-20	5mm/0.2"	0.01mm/0.0005"	0.01mm	45mm	20mm

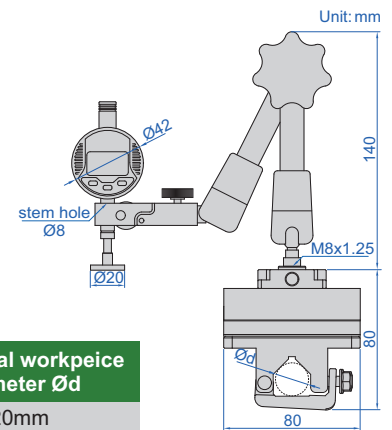

PARALLELISM COMPARISON GAUGE

CUSTOMIZED ACCORDING TO WORKPIECES

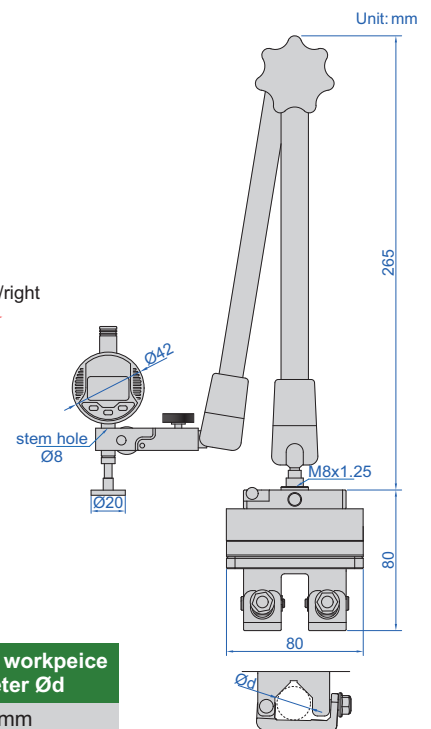
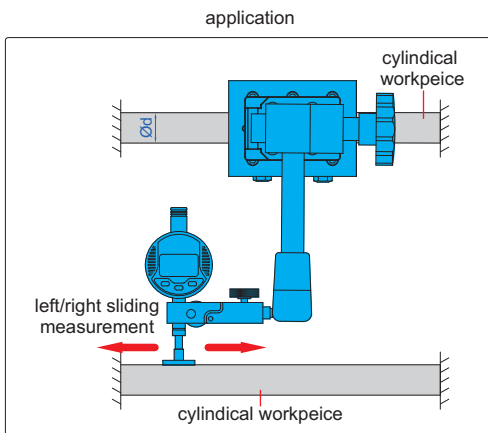

- Measurement parallelism between two cylinders
- Optional accessory: measurement software (code 7377)
wireless transmission code 7213-56 (receiver is needed) page 13

Code	Digital indicator stroke	Digital indicator resolution	Parallelism	Left/right slide stroke	Cylindrical workpiece diameter $\varnothing d$
2254-20	5mm/0.2"	0.01mm/0.0005"	0.01mm	45mm	20mm

PARALLELISM/PERPENDICULARITY COMPARISON GAUGE SOFTWARE CODE 7377



- Suitable for digital measurement of mechanical assembly such as equal height, parallelism, and perpendicularity
- Real-time collect of measurement data, automatic judgment of measurement results (out of upper tolerance, within tolerance, and out of lower tolerance), guiding measurement, prompting adjustment direction, and exporting measurement reports

Equal height comparison measurement

measurement value

guiding operation

project information

tolerance

data and result

Parallelism comparison measurement

measurement result and prompt adjustment

prompt deviation and guide adjustment direction

measurement value

measurement status

project information

tolerance

data and result

Perpendicularity comparison measurement

measurement result

measurement value

measurement status

project information

tolerance

data and result

DIGITAL THREAD PITCH MEASURING INSTRUMENT

MEET INTERNATIONAL STANDARD API5B

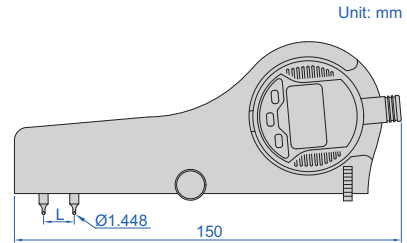

- Measure the pitch of external thread and internal thread with nominal diameter larger than 5 1/2" (139.7mm)
- Optional accessory: wireless transmitter code **7315-50M** (receiver is needed) page 6, bluetooth transmitter code **7214-50M** page 12, data output cable code **7302-50M** page 21, ball points (code **6252** series), standard pitch blocks (code **6251** series)

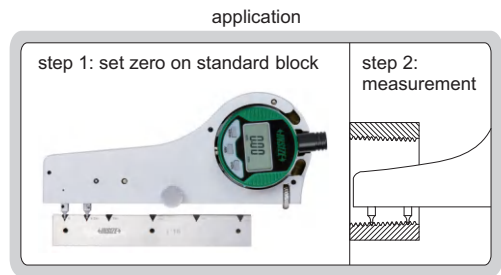

Code	Range (L)	Digital indicator stroke	Resolution	Accuracy
2245-4	0.5-4"/12.7-101.6mm	0.2"/5mm	0.0005"/0.01mm	0.02mm

THREAD PITCH MEASURING INSTRUMENTS

MEET INTERNATIONAL STANDARD API5B

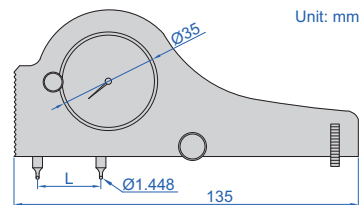

- Measure the pitch of external thread and internal thread with nominal diameter larger than 5 1/2" (139.7mm)
- Optional accessory: ball points (code **6252** series), standard pitch blocks (code **6251** series)

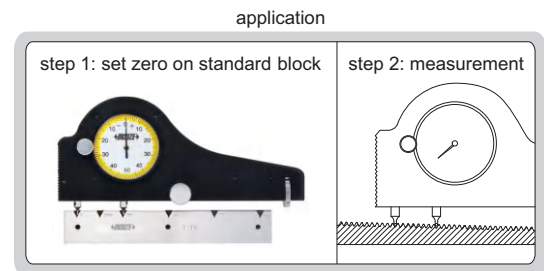

Code	Range (L)	Dial indicator stroke	Dial indicator graduation	Accuracy
2234-4	0.5-4"/12.7-101.6mm	0.5mm	0.01mm	0.02mm
2234-4E	0.5-4"/12.7-101.6mm	0.025"	0.0005"	0.0008"

MEET INTERNATIONAL STANDARD API5B

INTERNAL THREAD PITCH MEASURING INSTRUMENTS



2235-4

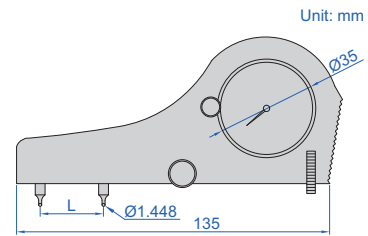

application

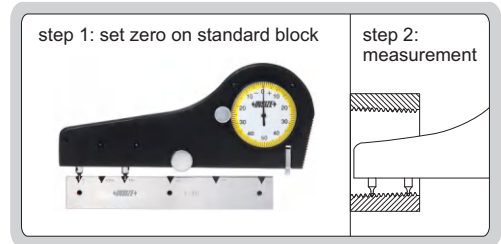

- Measure the pitch of internal thread with nominal diameter larger than 1 1/2" (38.1mm) and less than 5 1/2" (139.7mm)
- Optional accessory: ball points (code 6252 series), standard pitch blocks (code 6251 series)

Code	Range (L)	Dial indicator stroke	Dial indicator graduation	Accuracy
2235-4	0.5-4"/12.7-101.6mm	0.5mm	0.01mm	0.02mm
2235-4E	0.5-4"/12.7-101.6mm	0.025"	0.0005"	0.0008"

CAN BE CUSTOMIZED ACCORDING TO WORKPIECES

STANDARD PITCH BLOCKS

- Set zero of internal and external pitch measuring instruments (code 2234, 2235, 2245)



6251-S8

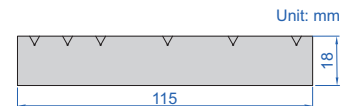

Code	Taper	Threads per inch
6251-S8	1:16	8, 10
6251-S5	1:16	5
6251-S4	1:6	4

BUTTRESS THREAD RUN-OUT GAUGE



2238-4

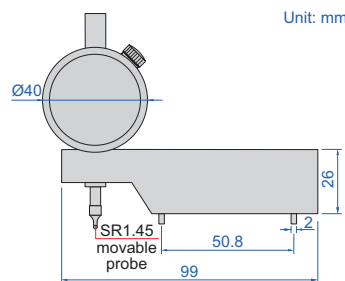

MEET INTERNATIONAL STANDARD API5B

application

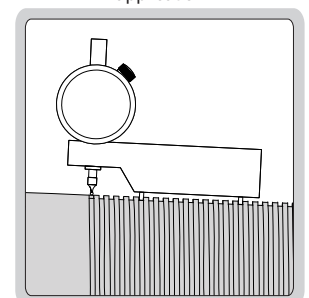

- The run-out gauge is used to check the run-out thread root and insure that the external thread is sufficiently long and is a true run-out thread

Code	Range	Dial indicator graduation	Dial indicator stroke	Accuracy
2238-4	0-4mm	0.01mm	5mm	0.02mm

BUTTRESS THREAD TOOTH THICKNESS GAUGES

MEET INTERNATIONAL STANDARD API5B



2239-21

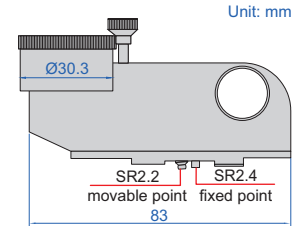

application

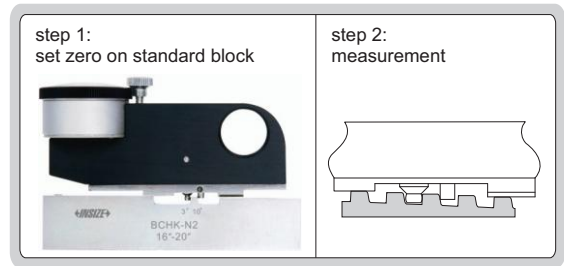

- Optional accessory: buttress thread tooth thickness standard blocks(code 6253 series)

11

Code	Range	Dial indicator graduation	Accuracy	Remark
2239-2	1mm	0.01mm	0.02mm	can measure 4 1/2"~13 3/8" buttress thread
2239-21	1mm	0.01mm	0.02mm	can measure ≥16" buttress thread

BUTTRESS THREAD TOOTH THICKNESS STANDARD BLOCKS

CAN BE CUSTOMIZED ACCORDING TO WORKPIECES



6253-N2

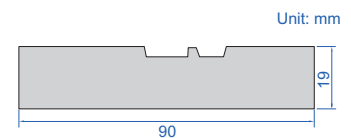

- Set zero of buttress thread tooth thickness gauges (code 2239 series)

Code	Taper	Threads per inch	Remark
6253-N1	1:16	5	can calibrate 4 1/2"~13 3/8" buttress internal thread gauge
6253-W1	1:16	5	can calibrate 4 1/2"~13 3/8" buttress external thread gauge
6253-N2	1:12	5	can calibrate ≥16" buttress internal thread gauge
6253-W2	1:12	5	can calibrate ≥16" buttress external thread gauge

MEET INTERNATIONAL
STANDARD API5B

DIGITAL EXTERNAL THREAD TAPER MEASURING INSTRUMENT

- Measure the taper of external thread
- Digital indicator stroke: 10mm/0.4"
- Optional accessory: wireless transmitter code **7315-50M** (receiver is needed) page 6, bluetooth transmitter code **7214-50M** page 12, data output cable code **7302-40M** page 21, ball points (code **6252** series)

principle of measurement

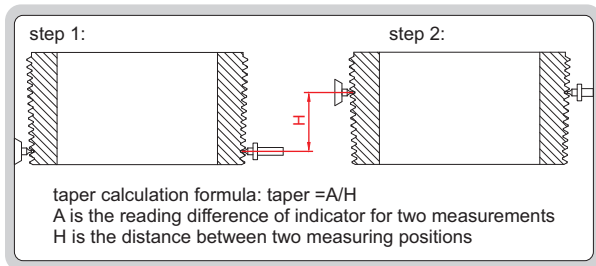

Code	Range (L)	Resolution	Accuracy
2240-10	0-10"/0-254mm	0.0005"/0.01mm	0.03mm

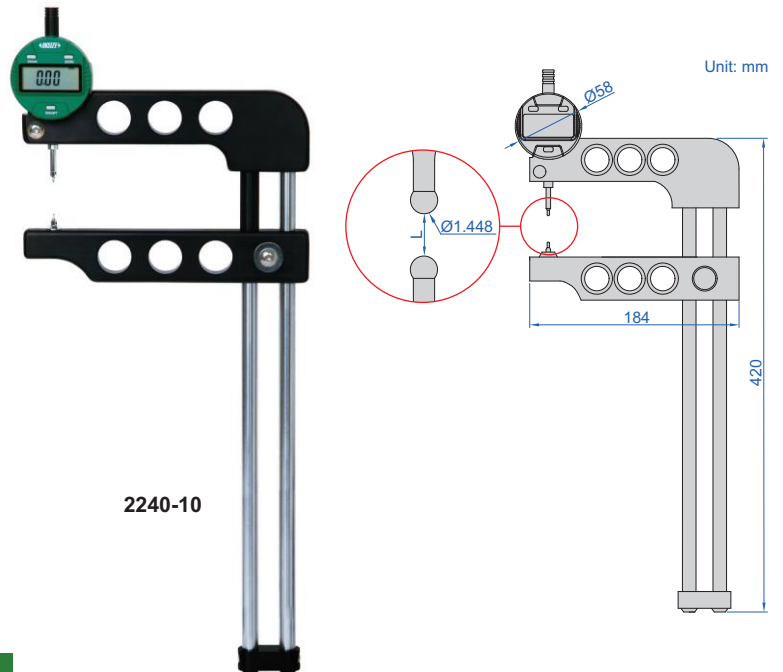

MEET INTERNATIONAL
STANDARD API5B

EXTERNAL THREAD TAPER MEASURING INSTRUMENTS

11

- Measure the taper of external thread
- Dial indicator stroke: 0.5"
- Dial indicator graduation: 0.001"
- Optional accessory: ball points (code **6252** series)

principle of measurement

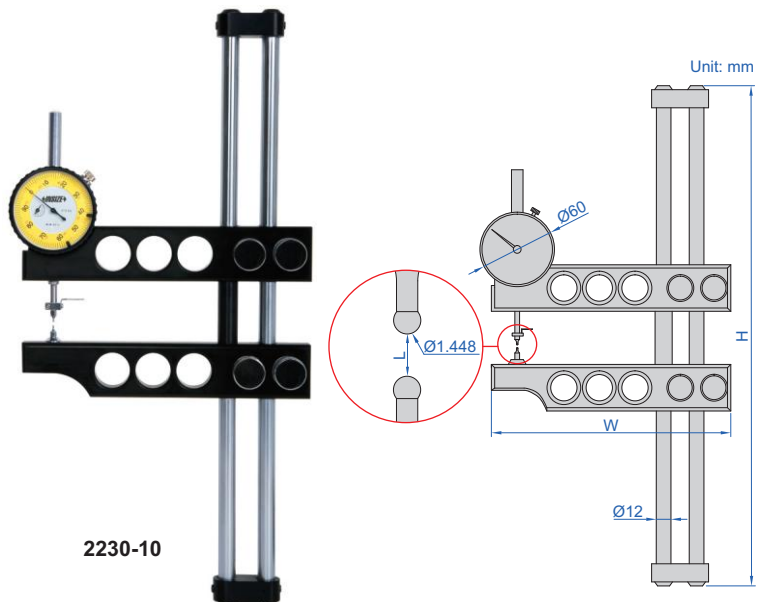
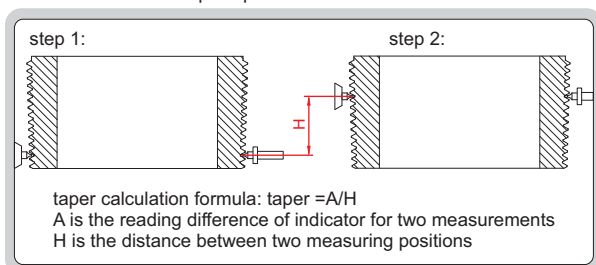

Code	Range (L)	Accuracy	H	W
2230-10	0-10"/0-254mm	0.0015"	400mm	200mm
2230-45	1-4 1/2"/25.4-114.3mm	0.0015"	278mm	178mm
2230-16	1-16"/25.4-406.4mm	0.0015"	600mm	260mm
2230-20	1-20"/25.4-508mm	0.0015"	680mm	260mm

INTERNAL THREAD TAPER MEASURING INSTRUMENTS

MEET INTERNATIONAL STANDARD API5B



2231-6



2231-16

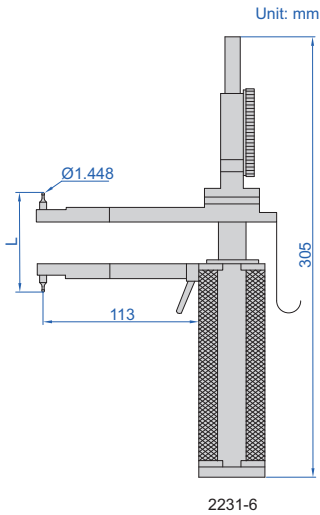

2231-6

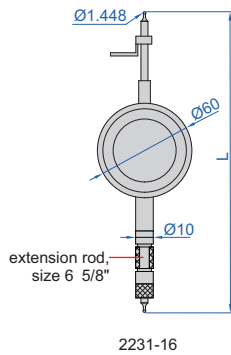

2231-16

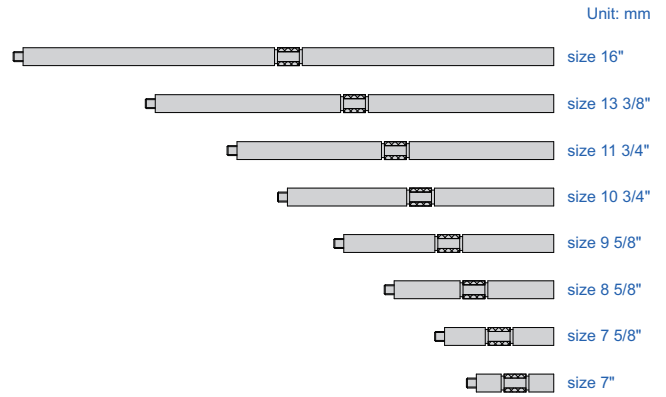

Unit: mm

principle of measurement

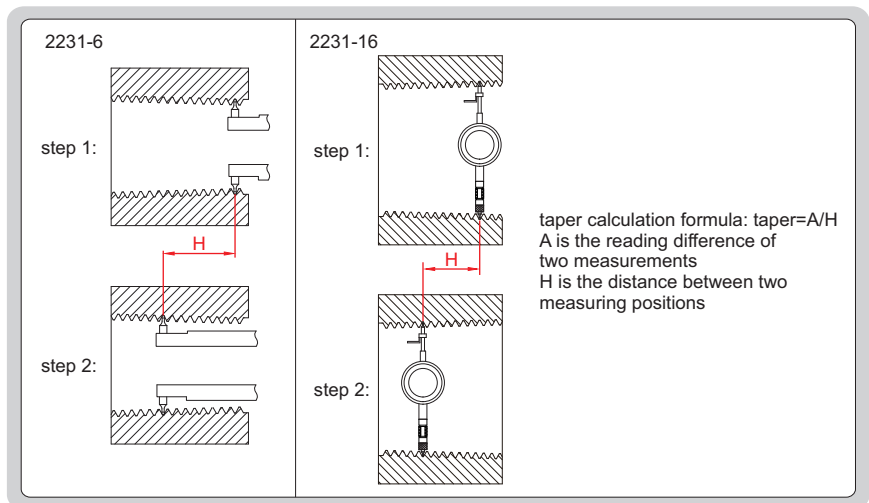

- Measure the taper of internal thread
- Optional accessory: ball points (code 6252 series)

Code	Range (L)	Dial indicator stroke	Dial indicator graduation	Accuracy	Remark
2231-6	1.5-6"/38.1-152.4mm	1"	0.001"	0.0015"	—
2231-16	5 1/2-16"/139.7-406.4mm	0.5"	0.001"	0.0015"	with 9 extension rods

MEET INTERNATIONAL
STANDARD API5B

DIGITAL INTERNAL THREAD TAPER MEASURING INSTRUMENT

principle of measurement

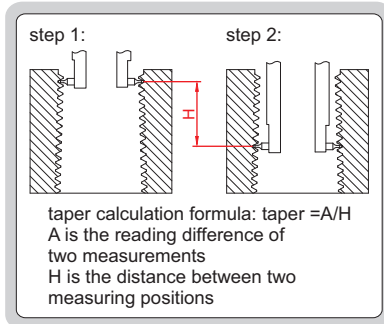

2241-6

- Measure the taper of internal thread
- Digital indicator stroke: 25.4mm/1"
- Optional accessory:
wireless transmitter code **7315-50M** (receiver is needed) page 6,
bluetooth transmitter code **7214-50M** page 12,
data output cable code **7302-40M** page 21,
ball points (code **6252** series)

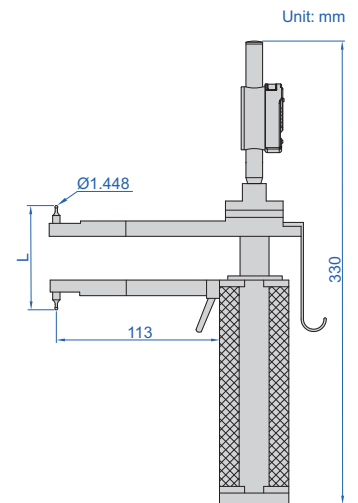

Code	Range (L)	Resolution	Accuracy
2241-6	1.5-6"/38.1-152.4mm	0.0005"/0.01mm	0.04mm

11

BALL POINTS

- Supplied in pair
- For taper measuring instruments (code **2230**, **2231**, **2240**, **2241**) and pitch measuring instruments (code **2234**, **2235**, **2245**)



6252-B10

Code	Thread type	Threads per inch	Ball dia. (Ød)	
			taper	pitch
6252-B8	round thread, line pipe	8	1.829mm	1.829mm
6252-B10	round thread, line pipe	10	1.448mm	1.448mm
6252-B115	line pipe	11.5	1.27mm	1.27mm
6252-B14	line pipe	14	1.041mm	1.041mm
6252-B18	line pipe	18	0.813mm	0.813mm
6252-B27	line pipe	27	0.533mm	0.533mm
6252-B5	buttress thread	5	2.286mm	—
6252-B51	buttress thread	5	—	1.575mm
6252-B52	extreme line thread	5,6	1.524mm	—
6252-B53	extreme line thread	5	—	2.667mm*
6252-B6	extreme line thread	6	—	2.210mm*

* 0.58mm off the top of ball

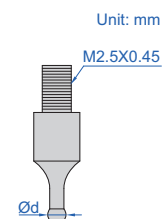

DIGITAL INTERNAL THREAD HEIGHT MEASURING INSTRUMENT

MEET INTERNATIONAL
STANDARD API5B

application

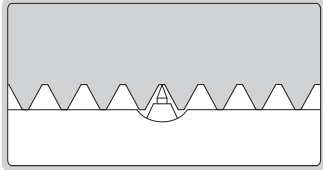

2243-35

- Measure the height of internal thread with nominal diameter less than 5 1/2" (139.7mm)
- Optional accessory: wireless transmitter code **7315-50M** (receiver is needed) page 6, bluetooth transmitter code **7214-50M** page 12, data output cable code **7302-50M** page 21, thread height standard blocks (code **6250**)

Code	Range	Resolution	Accuracy
2243-35	0-0.135"/0-3.5mm	0.0005"/0.01mm	0.02mm

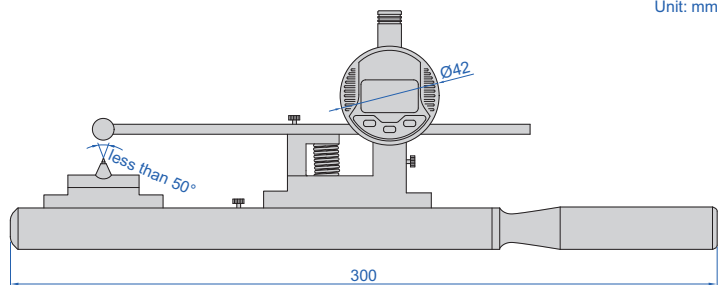

Unit: mm

INTERNAL THREAD HEIGHT MEASURING INSTRUMENTS

MEET INTERNATIONAL
STANDARD API5B

application

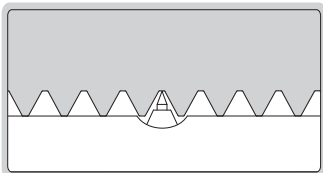

2233-35

- Measure the height of internal thread with nominal diameter less than 5 1/2" (139.7mm)
- Optional accessory: thread height standard blocks (code **6250**)

Code	Range	Dial indicator graduation	Accuracy
2233-35	0-3.5mm	0.01mm	0.02mm
2233-35E	0-1/4"	0.0005"	0.0008"

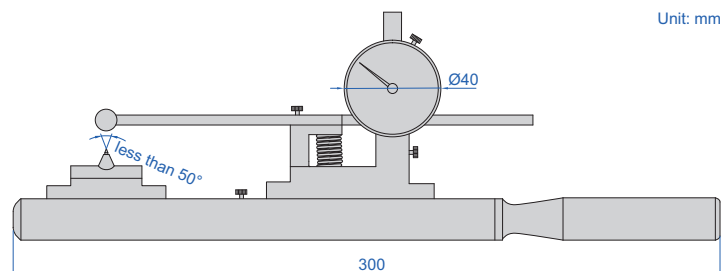

Unit: mm

MEET INTERNATIONAL
STANDARD API5B

DIGITAL THREAD HEIGHT MEASURING INSTRUMENT

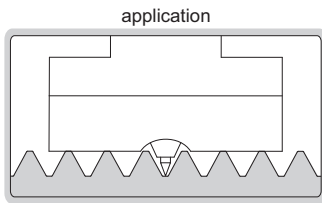

- Measure the height of external thread and internal thread with nominal diameter larger than 5 1/2" (139.7mm)
- Optional accessory: wireless transmitter code **7315-50M** (receiver is needed) page 6, bluetooth transmitter code **7214-50M** page 12, data output cable code **7302-40M** page 21, thread height standard blocks (code **6250**)



2242-35

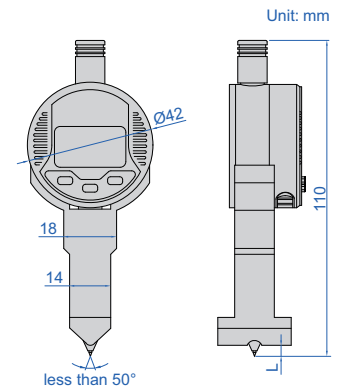

Code	Range (L)	Resolution	Accuracy
2242-35	0-0.135"/0-3.5mm	0.0005"/0.01mm	0.02mm

MEET INTERNATIONAL
STANDARD API5B

THREAD HEIGHT MEASURING INSTRUMENTS

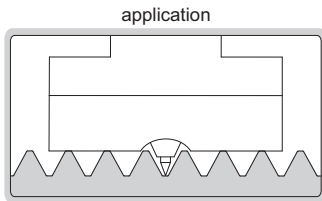

- Measure the height of external thread and internal thread with nominal diameter larger than 5 1/2" (139.7mm)
- Optional accessory: thread height standard blocks (code **6250**)



2232-35

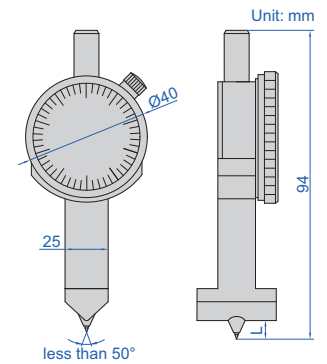

Code	Range (L)	Dial indicator graduation	Accuracy
2232-35	0-3.5mm	0.01mm	0.02mm
2232-35E	0-1/4"	0.0005"	0.0008"

CAN BE CUSTOMIZED
ACCORDING TO WORKPIECES

THREAD HEIGHT STANDARD BLOCKS

- Set zero of internal and external thread height measuring instruments (code **2232**, **2233**, **2242**, **2243**)

Code	Taper	Number of thread per inch
6250-4	1:4	4
6250-5	1:4	5
6250-8	1:16	8, 10
6250-51	1:16	5



6250-8

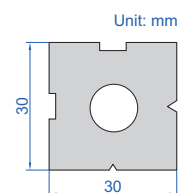

ROTARY SHOULDERS EXTERNAL THREAD CONNECTION HEIGHT MEASURING INSTRUMENTS

MEET INTERNATIONAL STANDARD API 7-2

application

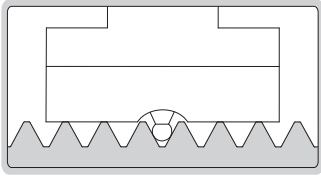

- Measure the height of rotary shouldered external thread connections
- Dial indicator graduation: 0.01mm
- Accuracy: 0.02mm
- Optional accessory: thread height standard blocks (code 6255)

Code	Form of thread to be inspected	Range (L)	A
2255-038	V-0.038R	0-3.5mm	Ø1.829mm
2255-040	V-0.040	0-3.5mm	Ø0.864mm
2255-050	V-0.050	0-5mm	Ø1.118mm
2255-055	V-0.055	0-3.5mm	Ø1.829mm

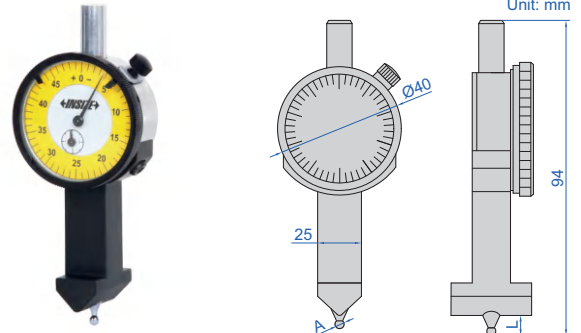

2255-038

ROTARY SHOULDERS INTERNAL THREAD CONNECTION HEIGHT MEASURING INSTRUMENTS

MEET INTERNATIONAL STANDARD API 7-2

application

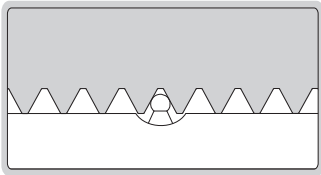

- Measure the height of rotary shouldered internal thread connections
- Dial indicator graduation: 0.01mm
- Accuracy: 0.02mm
- Optional accessory: thread height standard blocks (code 6255)

Code	Form of thread to be inspected	Range (L)	A
2256-038	V-0.038R	0-3.5mm	Ø1.829mm
2256-040	V-0.040	0-3.5mm	Ø0.864mm
2256-050	V-0.050	0-5mm	Ø1.118mm
2256-055	V-0.055	0-3.5mm	Ø1.829mm



2256-038

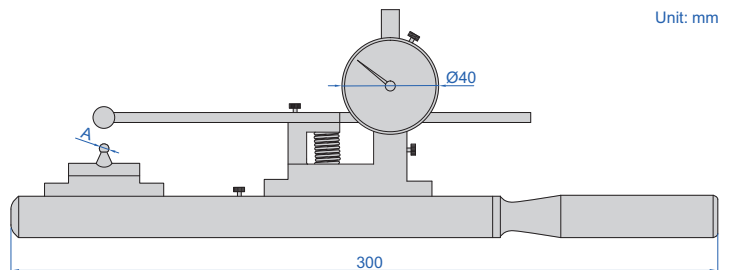

Unit: mm

THREAD HEIGHT STANDARD BLOCKS

CAN BE CUSTOMIZED ACCORDING TO WORKPIECES

- Set zero of internal and external thread height measuring instruments (code 2255, 2256)

Code	Form of thread to be inspected	Taper	Number of thread per inch
6255-038	V-0.038R	1:6 and 1:4	4
6255-040	V-0.040	1:4	5
6255-050	V-0.050	1:6 and 1:4	4
6255-055	V-0.055	1:8	6



6255-038

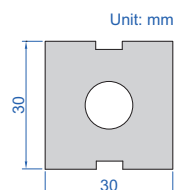

Unit: mm

REFER TO PAGE 97
FOR DETAILS

DIGITAL DEPTH GAUGE (60° KNIFE EDGE BASE)



front view

side view

2143-101

DIGITAL INTERNAL THREAD CREST DIAMETER MEASURING INSTRUMENT

MEET INTERNATIONAL
STANDARD API5B

Unit: mm

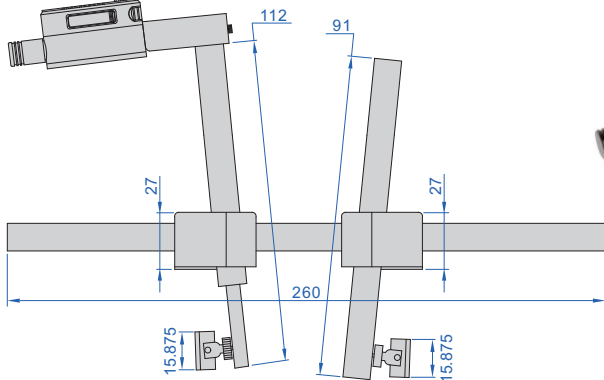

2247-5

application

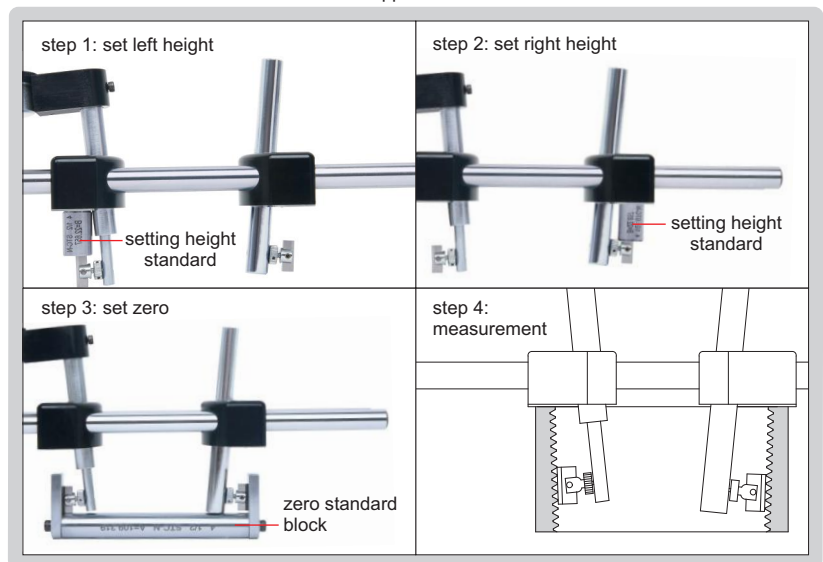

- Measure the crest diameter of internal thread with nominal diameter larger than 2 3/8" (60.325mm) and less than 5 1/2" (139.7mm)
- Optional accessory: wireless transmitter code **7315-50M** (receiver is needed) page 6, bluetooth transmitter code **7214-50M** page 12, data output cable code **7302-40M** page 21, height standard and zero standard block (code **2237-G□□□**, **2237-K□□□**)

Code	Range	Digital indicator stroke	Resolution	Accuracy
2247-5	2 3/8-5 1/2"/60.325-139.7mm	0.2"/5mm	0.0005"/0.01mm	0.02mm

INTERNAL THREAD CREST DIAMETER MEASURING INSTRUMENTS

MEET INTERNATIONAL STANDARD API5B



2237-5

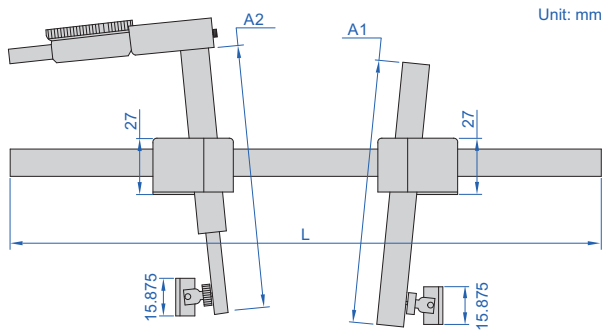

application

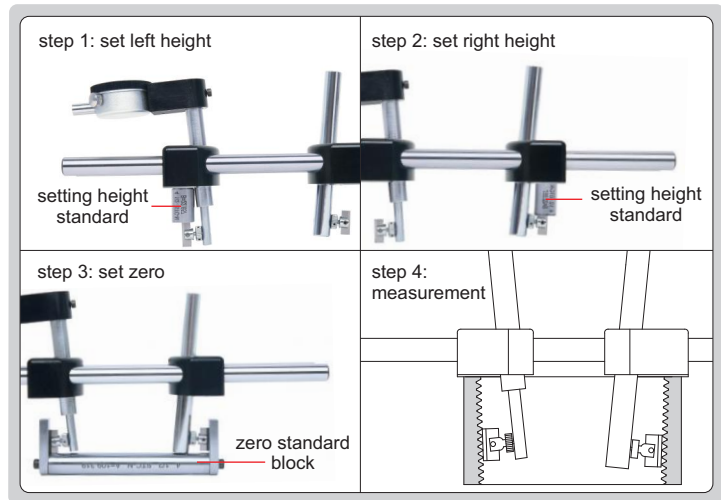

11

- Measure the crest diameter of internal thread with nominal diameter larger than 2 3/8" (60.325mm) and less than 20" (508mm)
- Optional accessory: height standard and zero standard block

Code	Range	Dial indicator stroke	Dial indicator graduation	Accuracy	L	A1	A2
2237-5	2 3/8-5 1/2"/60.325-139.7mm	5mm	0.01mm	0.02mm	260mm	112mm	91mm
2237-5E	2 3/8-5 1/2"/60.325-139.7mm	0.25"	0.0005"	0.0008"	260mm	112mm	91mm
2237-20	4 1/2-20"/114.3-508mm	0.50"	0.0005"	0.002"	12", 18" or 24" *	177mm	182mm

* Select suitable length of arm according to workpieces

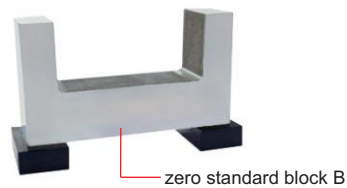

HEIGHT STANDARD AND ZERO STANDARD BLOCK (optional)

Code	Remark
2237-G□□**	including height standard and zero standard block A (without taper)
2237-K□□**	including height standard and zero standard block B (with taper)

** Can be customized according to workpieces

DIGITAL EXTERNAL THREAD CREST DIAMETER MEASURING INSTRUMENT

MEET INTERNATIONAL
STANDARD API5B



2246-5

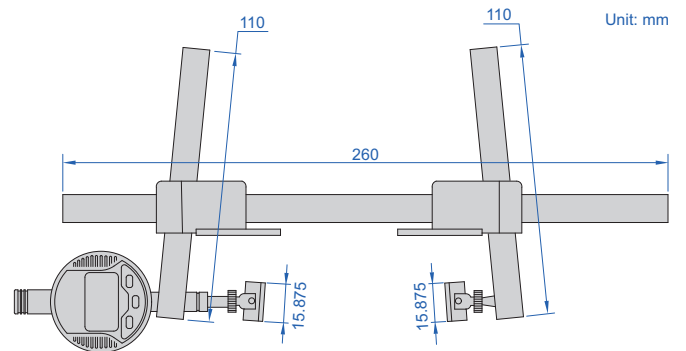

- Measure the crest diameter of external thread with nominal diameter larger than 2 3/8" (60.325mm) and less than 5 1/2" (139.7mm)
- Optional accessory: wireless transmitter code **7315-50M** (receiver is needed) page 6, bluetooth transmitter code **7214-50M** page 12, data output cable code **7302-40M** page 21, height standard and zero standard block (code **2236-G**□□□, **2236-K**□□□)

application

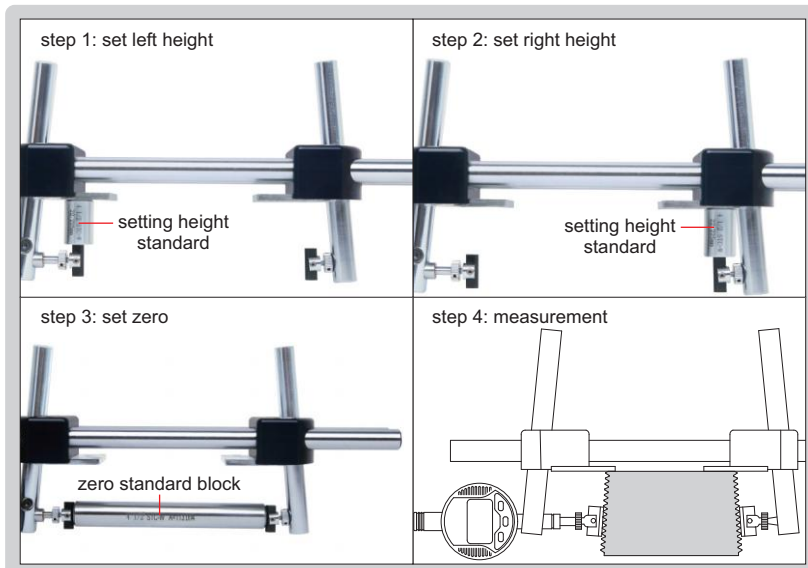

Code	Range	Digital indicator stroke	Resolution	Accuracy
2246-5	2 3/8-5 1/2"/60.325-139.7mm	0.2"/5mm	0.0005"/0.01mm	0.02mm

EXTERNAL THREAD CREST DIAMETER MEASURING INSTRUMENTS

MEET INTERNATIONAL STANDARD API5B



2236-5

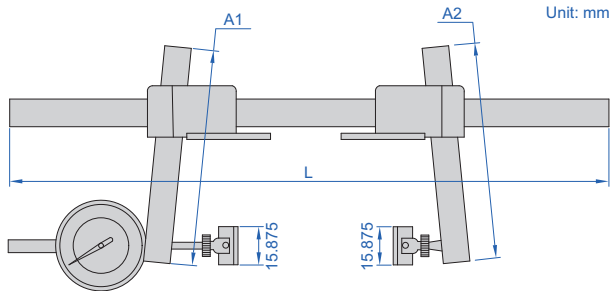

application

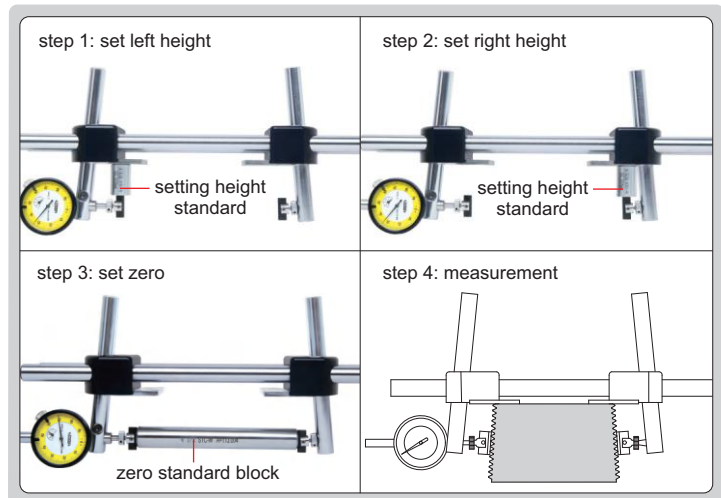

- Measure the crest diameter of external thread with nominal diameter larger than 2 3/8" (60.325mm) and less than 20" (508mm)
- Optional accessory: height standard and zero standard block

Code	Range	Dial indicator stroke	Dial indicator graduation	Accuracy	L	A1	A2
2236-5	2 3/8-5 1/2"/60.325-139.7mm	5mm	0.01mm	0.02mm	260mm	110mm	110mm
2236-5E	2 3/8-5 1/2"/60.325-139.7mm	0.25"	0.0005"	0.0008"	260mm	110mm	110mm
2236-20	2 3/8-20"/60.325-508mm	0.50"	0.0005"	0.002"	12", 18" or 24"*	177mm	160mm

* Select suitable length of arm according to workpieces

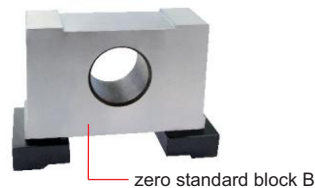

HEIGHT STANDARD AND ZERO STANDARD BLOCK (optional)

Code	Remark
2236-G□□**	including height standard and zero standard block A (without taper)
2236-K□□**	including height standard and zero standard block B (with taper)

** Can be customized according to workpieces

DIGITAL GROOVE DIAMETER MEASURING INSTRUMENT



2261-5

POINT DIAMETER CAN BE CUSTOM-MADE

application

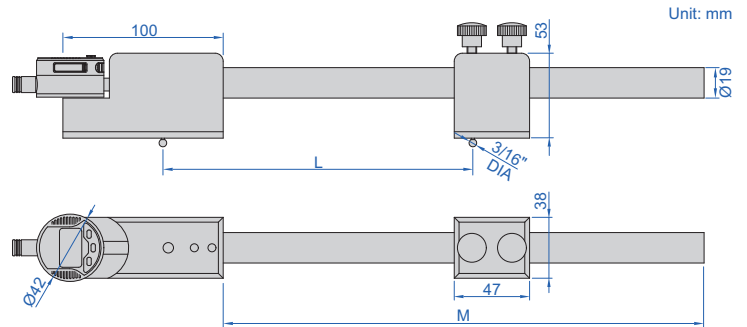
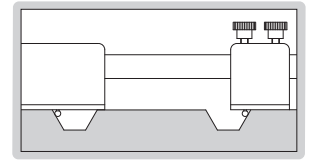

Unit: mm

- Measure the groove diameter of flange ring groove
- Point height is adjustable
- Optional accessory:
wireless transmitter code **7315-50M** (receiver is needed) page 6,
bluetooth transmitter code **7214-50M** page 12,
data output cable code **7302-40M** page 21,
groove standard block (code **6254**)

Stem (optional)

Code	M
2261-M24	24"/600mm
2261-M30	30"/750mm
2261-M36	36"/900mm

Code	Range (L)	Movable point stroke	Resolution	Repeatability	M
2261-5	2.6-13"/66-330mm	0.2"/5mm	0.00005"/0.001mm	0.002mm	12"/300mm

GROOVE DIAMETER MEASURING INSTRUMENTS

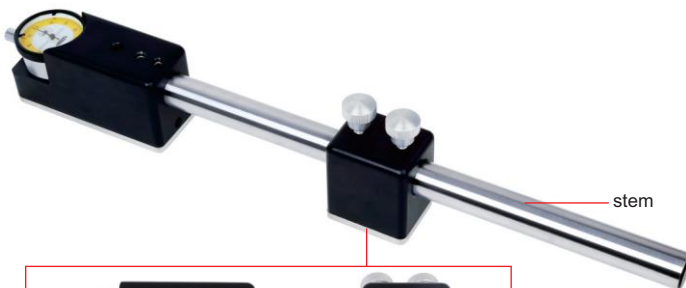

2251-5

POINT DIAMETER CAN BE CUSTOM-MADE

application

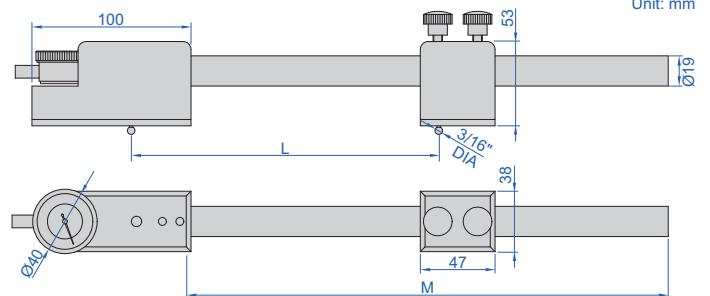
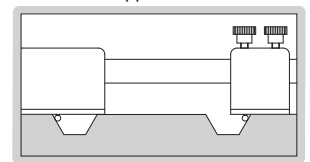

Unit: mm

- Measure the groove diameter of flange ring groove
- Point height is adjustable
- Optional: groove standard block (code **6254**)

Stem (optional)

Code	M
2261-M24	24"/600mm
2261-M30	30"/750mm
2261-M36	36"/900mm

Code	Range (L)	Movable point stroke	Graduation	Repeatability	M
2251-5	2.6-13"/66-330mm	0.2"/5mm	0.01mm	0.005mm	12"/300mm
2251-5E	2.6-13"/66-330mm	0.2"/5mm	0.0005"	0.0002"	12"/300mm

DIGITAL GROOVE WIDTH MEASURING INSTRUMENT

POINT DIAMETER CAN BE CUSTOM-MADE

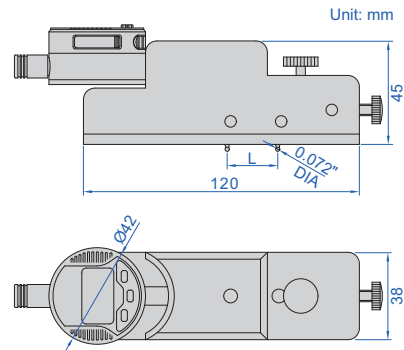
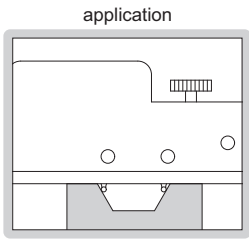

2260-4

- Measure the groove width of flange ring groove
- Point height is adjustable
- Optional accessory: wireless transmitter code **7315-50M** (receiver is needed) page 6, bluetooth transmitter code **7214-50M** page 12, data output cable code **7302-40M** page 21, groove standard block (code **6254**)

Code	Range (L)	Movable point stroke	Resolution	Repeatability
2260-4	0.55-1.4"/14-35.5mm	0.16"/4mm	0.00005"/0.001mm	0.002mm

GROOVE WIDTH MEASURING INSTRUMENTS

POINT DIAMETER CAN BE CUSTOM-MADE

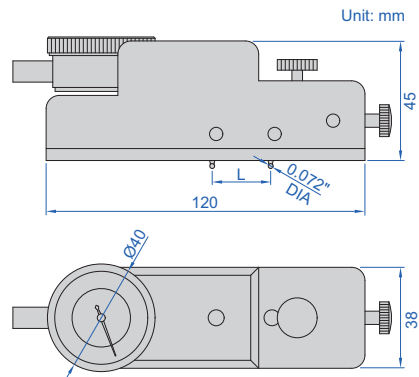
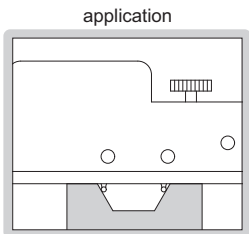

2250-4

- Measure the groove width of flange ring groove
- Point height is adjustable
- Optional: groove standard block (code **6254**)

Code	Range (L)	Movable point stroke	Graduation	Repeatability
2250-4	0.55-1.4"/14-35.5mm	0.16"/4mm	0.01mm	0.005mm
2250-4E	0.55-1.4"/14-35.5mm	0.16"/4mm	0.0005"	0.0002"

STANDARD GROOVE BLOCK CODE 6254

CUSTOM-MADE



- Set zero of groove width and groove diameter measuring instruments (code **2250, 2251, 2260, 2261**)

REFER TO PAGE 77
FOR DETAILS

DIGITAL CALIPERS WITH INTERCHANGEABLE BALL TIPS



1527-3001

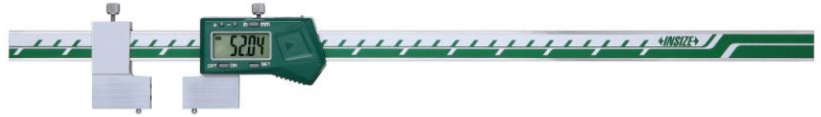

1528-3001

REFER TO PAGE 76
FOR DETAILS

DIGITAL RTJ RING GROOVE CALIPERS



1179-300



1179-600

REFER TO PAGE 403
FOR DETAILS

THREAD GAUGES FOR ROTARY SHOULDERED CONNECTIONS OF PETROLEUM EQUIPMENT



4177-23

REFER TO PAGE
404-405 FOR DETAILS

CASING, TUBING AND LINE PIPE THREAD GAUGES OF PETROLEUM AND GAS EQUIPMENT



4178-21T

12

STANDARDS AND GAUGE BLOCKS

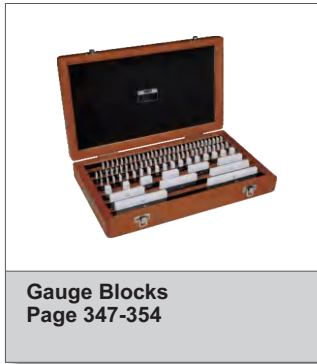

Gauge Blocks
Page 347-354

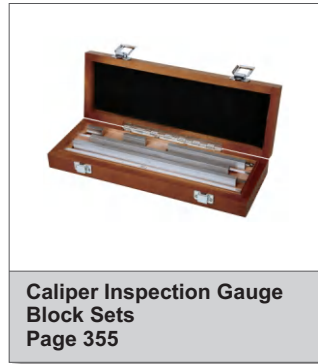

Caliper Inspection Gauge Block Sets
Page 355

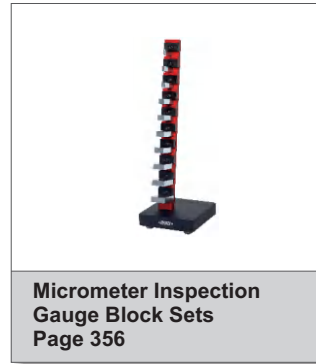

Micrometer Inspection Gauge Block Sets
Page 356

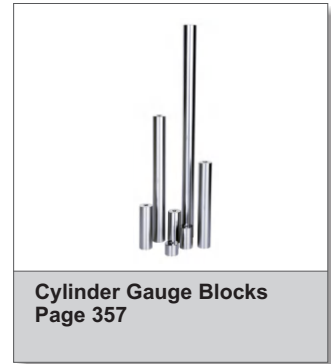

Cylinder Gauge Blocks
Page 357

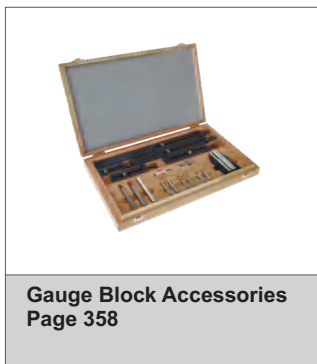

Gauge Block Accessories
Page 358



Gauge Block Holders
Page 359



Caliper/Height Gauge Checkers
Page 360

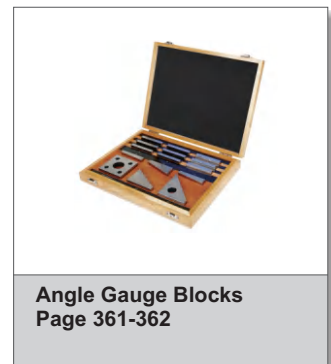

Angle Gauge Blocks
Page 361-362



Pin Gauges
Page 362-366



Pin Gauge Handles
Page 367-369

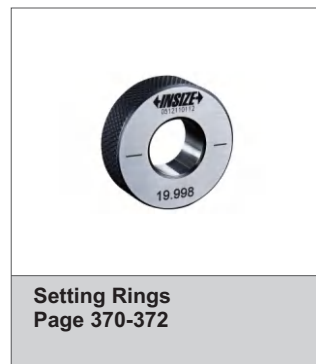

Setting Rings
Page 370-372



Cylinder Gauges
Page 373

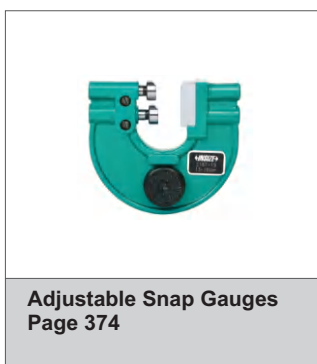

Adjustable Snap Gauges
Page 374



Plain Plug Gauges
Page 375-378



Spline Ring/Plug Gauges
Page 378-379

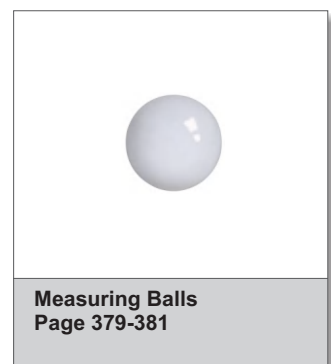

Measuring Balls
Page 379-381



**Threaded Hole Location
Gauges**
Page 381-382



Thread Depth Gauges
Page 383-384



Thread Ring/Plug Gauges
Page 385-405



**Semi-Automatic Thread
Inspectors**
Page 405-406



**External Thread
Measuring Devices**
Page 407-408

GAUGE BLOCKS

Accuracy according to ISO3650

Nominal length (mm)	Grade 0		Grade 1		Grade 2	
	Limit deviation of length	Tolerance for the variation in length	Limit deviation of length	Tolerance for the variation in length	Limit deviation of length	Tolerance for the variation in length
over 0.5 to 10	±0.12µm	0.10µm	±0.20µm	0.16µm	±0.45µm	0.30µm
over 10 to 25	±0.14µm	0.10µm	±0.30µm	0.16µm	±0.60µm	0.30µm
over 25 to 50	±0.20µm	0.10µm	±0.40µm	0.18µm	±0.80µm	0.30µm
over 50 to 75	±0.25µm	0.12µm	±0.50µm	0.18µm	±1.00µm	0.35µm
over 75 to 100	±0.30µm	0.12µm	±0.60µm	0.20µm	±1.20µm	0.35µm
over 100 to 150	±0.40µm	0.14µm	±0.80µm	0.20µm	±1.60µm	0.40µm
over 150 to 200	±0.50µm	0.16µm	±1.00µm	0.25µm	±2.00µm	0.40µm
over 200 to 250	±0.60µm	0.16µm	±1.20µm	0.25µm	±2.40µm	0.45µm
over 250 to 300	±0.70µm	0.18µm	±1.40µm	0.25µm	±2.80µm	0.50µm
over 300 to 400	±0.90µm	0.20µm	±1.80µm	0.30µm	±3.60µm	0.50µm
over 400 to 500	±1.10µm	0.25µm	±2.20µm	0.35µm	±4.40µm	0.60µm
over 500 to 600	±1.30µm	0.25µm	±2.60µm	0.40µm	±5.00µm	0.70µm
over 600 to 700	±1.50µm	0.30µm	±3.00µm	0.45µm	±6.00µm	0.70µm
over 700 to 800	±1.70µm	0.30µm	±3.40µm	0.50µm	±6.50µm	0.80µm
over 800 to 900	±1.90µm	0.35µm	±3.80µm	0.50µm	±7.50µm	0.90µm
over 900 to 1000	±2.00µm	0.40µm	±4.20µm	0.60µm	±8.00µm	1.00µm

Grade and application

Grade	Application
0	To be used as basic standards in calibration laboratories by skilled inspection staff, to calibrate or set high accuracy measuring instruments, to calibrate gauge blocks of grade 1 and 2.
1	To be used in inspection rooms, to check gauges, inspect high accuracy parts and set measuring instruments.
2	To be used in workshops, to check production gauges, set measuring instruments and mount tools.

12

WEAR BLOCK SETS



- Protect the measuring surfaces of gauge blocks from excessive wear
- Meet ISO3650
- Supplied with manufacturer inspection certificate

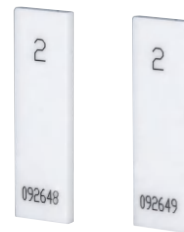

4111-2

Blocks per set	Size	Material	Code	
			Grade 0	Grade 1
2	1.0mm	ceramic	4111-1	4111-11
2	1.0mm	alloy steel	4111-1A	4111-11A
2	2.0mm	ceramic	4111-2	4111-12
2	2.0mm	alloy steel	4111-2A	4111-12A

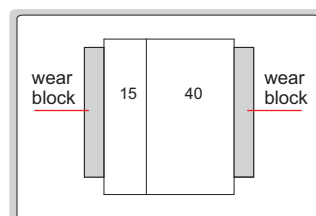

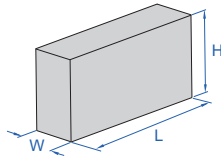

Dimension:

Size (L)	W	H
0.5 ≤ L ≤ 10mm	9mm	30mm
L > 10mm	9mm	35mm



4105-87

- Made of ceramic, extremely wear resistance and corrosion resistance, excellent dimension stability
- Meet ISO3650
- Supplied with manufacturer inspection certificate

Blocks per set	Gauge blocks included in set			Code	
	Size (mm)	Step (mm)	Quantity	Grade 0	Grade 1
112	1.0005		1	4105-112	4105-1112
	1.001-1.009	0.001	9		
	1.01-1.49	0.01	49		
	0.5-24.5	0.5	49		
	25-100	25	4		
103	1.005		1	4105-103	4105-1103
	1.01-1.49	0.01	49		
	0.5-24.5	0.5	49		
	25-100	25	4		
88	1.0005		1	4105-88	4105-188
	1.001-1.009	0.001	9		
	1.01-1.49	0.01	49		
	0.5-9.5	0.5	19		
	10-100	10	10		
87	1.001-1.009	0.001	9	4105-87	4105-187
	1.01-1.49	0.01	49		
	0.5-9.5	0.5	19		
	10-100	10	10		
76	1.005		1	4105-76	4105-176
	1.01-1.49	0.01	49		
	0.5-9.5	0.5	19		
	10-40	10	4		
	50-100	25	3		
56	0.5		1	4105-56	4105-156
	1.001-1.009	0.001	9		
	1.01-1.09	0.01	9		
	1.1-1.9	0.1	9		
	1-24	1	24		
	25-100	25	4		

Blocks per set	Gauge blocks included in set			Code	
	Size (mm)	Step (mm)	Quantity	Grade 0	Grade 1
47	1.005		1	4105-47A	4105-147A
	1.01-1.09	0.01	9		
	1.1-1.9	0.1	9		
	1-24	1	24		
	25-100	25	4		
47	1.005		1	4105-47	4105-147
	1.01-1.19	0.01	19		
	1.2-1.9	0.1	8		
	1-9	1	9		
	10-100	10	10		
46	1.001-1.009	0.001	9	4105-46	4105-146
	1.01-1.09	0.01	9		
	1.1-1.9	0.1	9		
	1-9	1	9		
	10-100	10	10		
34	1.0005		1	4105-34	4105-134
	1.001-1.009	0.001	9		
	1.01-1.09	0.01	9		
	1.1-1.9	0.1	9		
	1-5	1	5		
32	1.005		1	4105-32	4105-132
	1.01-1.09	0.01	9		
	1.1-1.9	0.1	9		
	1-9	1	9		
	10-30	10	3		
	50	1			

CERAMIC INDIVIDUAL GAUGE BLOCKS



4106-A80

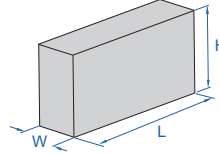

Dimension:

Size (L)	W	H
0.5 ≤ L ≤ 10mm	9mm	30mm
L > 10mm	9mm	35mm

- Grade 0 and 1 gauge blocks are available
- Made of ceramic, extremely wear resistance and corrosion resistance
- Meet ISO3650
- Supplied with manufacturer inspection certificate

Code explanation:

4106-X□□□□

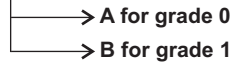

Code examples:

Size (L)	Grade	Code
0.5mm	0	4106-AD5
10mm	1	4106-B10

12

Size	Code	Size	Code	Size	Code	Size	Code
0.5mm	4106- <u>X</u> D5	1.23mm	4106- <u>X</u> 1D23	3mm	4106- <u>X</u> 3	17.6mm	4106- <u>X</u> 17D6
1mm	4106- <u>X</u> 1	1.24mm	4106- <u>X</u> 1D24	3.5mm	4106- <u>X</u> 3D5	18mm	4106- <u>X</u> 18
1.0005mm	4106- <u>X</u> 1D0005	1.25mm	4106- <u>X</u> 1D25	4mm	4106- <u>X</u> 4	18.5mm	4106- <u>X</u> 18D5
1.001mm	4106- <u>X</u> 1D001	1.26mm	4106- <u>X</u> 1D26	4.5mm	4106- <u>X</u> 4D5	19mm	4106- <u>X</u> 19
1.002mm	4106- <u>X</u> 1D002	1.27mm	4106- <u>X</u> 1D27	5mm	4106- <u>X</u> 5	19.5mm	4106- <u>X</u> 19D5
1.003mm	4106- <u>X</u> 1D003	1.28mm	4106- <u>X</u> 1D28	5.1mm	4106- <u>X</u> 5D1	20mm	4106- <u>X</u> 20
1.004mm	4106- <u>X</u> 1D004	1.29mm	4106- <u>X</u> 1D29	5.5mm	4106- <u>X</u> 5D5	20.2mm	4106- <u>X</u> 20D2
1.005mm	4106- <u>X</u> 1D005	1.3mm	4106- <u>X</u> 1D3	6mm	4106- <u>X</u> 6	20.5mm	4106- <u>X</u> 20D5
1.006mm	4106- <u>X</u> 1D006	1.31mm	4106- <u>X</u> 1D31	6.5mm	4106- <u>X</u> 6D5	21mm	4106- <u>X</u> 21
1.007mm	4106- <u>X</u> 1D007	1.32mm	4106- <u>X</u> 1D32	7mm	4106- <u>X</u> 7	21.5mm	4106- <u>X</u> 21D5
1.008mm	4106- <u>X</u> 1D008	1.33mm	4106- <u>X</u> 1D33	7.5mm	4106- <u>X</u> 7D5	22mm	4106- <u>X</u> 22
1.009mm	4106- <u>X</u> 1D009	1.34mm	4106- <u>X</u> 1D34	7.7mm	4106- <u>X</u> 7D7	22.5mm	4106- <u>X</u> 22D5
1.01mm	4106- <u>X</u> 1D01	1.35mm	4106- <u>X</u> 1D35	8mm	4106- <u>X</u> 8	22.8mm	4106- <u>X</u> 22D8
1.02mm	4106- <u>X</u> 1D02	1.36mm	4106- <u>X</u> 1D36	8.5mm	4106- <u>X</u> 8D5	23mm	4106- <u>X</u> 23
1.03mm	4106- <u>X</u> 1D03	1.37mm	4106- <u>X</u> 1D37	9mm	4106- <u>X</u> 9	23.5mm	4106- <u>X</u> 23D5
1.04mm	4106- <u>X</u> 1D04	1.38mm	4106- <u>X</u> 1D38	9.5mm	4106- <u>X</u> 9D5	24mm	4106- <u>X</u> 24
1.05mm	4106- <u>X</u> 1D05	1.39mm	4106- <u>X</u> 1D39	10mm	4106- <u>X</u> 10	24.5mm	4106- <u>X</u> 24D5
1.06mm	4106- <u>X</u> 1D06	1.4mm	4106- <u>X</u> 1D4	10.3mm	4106- <u>X</u> 10D3	25mm	4106- <u>X</u> 25
1.07mm	4106- <u>X</u> 1D07	1.41mm	4106- <u>X</u> 1D41	10.5mm	4106- <u>X</u> 10D5	30mm	4106- <u>X</u> 30
1.08mm	4106- <u>X</u> 1D08	1.42mm	4106- <u>X</u> 1D42	11mm	4106- <u>X</u> 11	40mm	4106- <u>X</u> 40
1.09mm	4106- <u>X</u> 1D09	1.43mm	4106- <u>X</u> 1D43	11.5mm	4106- <u>X</u> 11D5	41.3mm	4106- <u>X</u> 41D3
1.1mm	4106- <u>X</u> 1D1	1.44mm	4106- <u>X</u> 1D44	12mm	4106- <u>X</u> 12	50mm	4106- <u>X</u> 50
1.11mm	4106- <u>X</u> 1D11	1.45mm	4106- <u>X</u> 1D45	12.5mm	4106- <u>X</u> 12D5	60mm	4106- <u>X</u> 60
1.12mm	4106- <u>X</u> 1D12	1.46mm	4106- <u>X</u> 1D46	12.9mm	4106- <u>X</u> 12D9	70mm	4106- <u>X</u> 70
1.13mm	4106- <u>X</u> 1D13	1.47mm	4106- <u>X</u> 1D47	13mm	4106- <u>X</u> 13	75mm	4106- <u>X</u> 75
1.14mm	4106- <u>X</u> 1D14	1.48mm	4106- <u>X</u> 1D48	13.5mm	4106- <u>X</u> 13D5	80mm	4106- <u>X</u> 80
1.15mm	4106- <u>X</u> 1D15	1.49mm	4106- <u>X</u> 1D49	14mm	4106- <u>X</u> 14	90mm	4106- <u>X</u> 90
1.16mm	4106- <u>X</u> 1D16	1.5mm	4106- <u>X</u> 1D5	14.5mm	4106- <u>X</u> 14D5	100mm	4106- <u>X</u> 100
1.17mm	4106- <u>X</u> 1D17	1.6mm	4106- <u>X</u> 1D6	15mm	4106- <u>X</u> 15	125mm	4106- <u>X</u> 125
1.18mm	4106- <u>X</u> 1D18	1.7mm	4106- <u>X</u> 1D7	15.5mm	4106- <u>X</u> 15D5	131.4mm	4106- <u>X</u> 131D4
1.19mm	4106- <u>X</u> 1D19	1.8mm	4106- <u>X</u> 1D8	16mm	4106- <u>X</u> 16	150mm	4106- <u>X</u> 150
1.2mm	4106- <u>X</u> 1D2	1.9mm	4106- <u>X</u> 1D9	16.5mm	4106- <u>X</u> 16D5		
1.21mm	4106- <u>X</u> 1D21	2mm	4106- <u>X</u> 2	17mm	4106- <u>X</u> 17		
1.22mm	4106- <u>X</u> 1D22	2.5mm	4106- <u>X</u> 2D5	17.5mm	4106- <u>X</u> 17D5		

CUSTOM-MADE
CAN SUPPLY ANY SIZES FROM
0.5 TO 100MM, SUCH AS 70.672MM



CERAMIC INDIVIDUAL GAUGE BLOCKS

INSIZE PLUS
MADE IN EUROPE



4103-A80

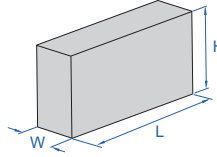

Dimension:

Size (L)	W	H
0.5 ≤ L ≤ 10mm	9mm	30mm
L > 10mm	9mm	35mm

- Grade K, 0 and 1 gauge blocks are available
- Made of ceramic, extremely wear resistance and corrosion resistance
- Meet ISO3650
- Supplied with manufacturer inspection certificate

Code explanation:

4103-X□□□□

- K for grade K
- A for grade 0
- B for grade 1

Code examples:

Size (L)	Grade	Code
0.5mm	K	4103-KD5
10mm	0	4103-A10
10mm	1	4103-B10

Size	Code
0.5mm	4103-XD5
1mm	4103-X1
1.0005mm	4103-X1D0005
1.001mm	4103-X1D001
1.002mm	4103-X1D002
1.003mm	4103-X1D003
1.004mm	4103-X1D004
1.005mm	4103-X1D005
1.006mm	4103-X1D006
1.007mm	4103-X1D007
1.008mm	4103-X1D008
1.009mm	4103-X1D009
1.01mm	4103-X1D01
1.02mm	4103-X1D02
1.03mm	4103-X1D03
1.04mm	4103-X1D04
1.05mm	4103-X1D05
1.06mm	4103-X1D06
1.07mm	4103-X1D07
1.08mm	4103-X1D08
1.09mm	4103-X1D09
1.1mm	4103-X1D1
1.11mm	4103-X1D11
1.12mm	4103-X1D12
1.13mm	4103-X1D13
1.14mm	4103-X1D14
1.15mm	4103-X1D15
1.16mm	4103-X1D16
1.17mm	4103-X1D17
1.18mm	4103-X1D18
1.19mm	4103-X1D19
1.2mm	4103-X1D2
1.21mm	4103-X1D21
1.22mm	4103-X1D22

Size	Code
1.23mm	4103-X1D23
1.24mm	4103-X1D24
1.25mm	4103-X1D25
1.26mm	4103-X1D26
1.27mm	4103-X1D27
1.28mm	4103-X1D28
1.29mm	4103-X1D29
1.3mm	4103-X1D3
1.31mm	4103-X1D31
1.32mm	4103-X1D32
1.33mm	4103-X1D33
1.34mm	4103-X1D34
1.35mm	4103-X1D35
1.36mm	4103-X1D36
1.37mm	4103-X1D37
1.38mm	4103-X1D38
1.39mm	4103-X1D39
1.4mm	4103-X1D4
1.41mm	4103-X1D41
1.42mm	4103-X1D42
1.43mm	4103-X1D43
1.44mm	4103-X1D44
1.45mm	4103-X1D45
1.46mm	4103-X1D46
1.47mm	4103-X1D47
1.48mm	4103-X1D48
1.49mm	4103-X1D49
1.5mm	4103-X1D5
1.6mm	4103-X1D6
1.7mm	4103-X1D7
1.8mm	4103-X1D8
1.9mm	4103-X1D9
2mm	4103-X2
2.5mm	4103-X2D5

Size	Code
3mm	4103-X3
3.5mm	4103-X3D5
4mm	4103-X4
4.5mm	4103-X4D5
5mm	4103-X5
5.5mm	4103-X5D5
6mm	4103-X6
6.5mm	4103-X6D5
7mm	4103-X7
7.5mm	4103-X7D5
8mm	4103-X8
8.5mm	4103-X8D5
9mm	4103-X9
9.5mm	4103-X9D5
10mm	4103-X10
10.5mm	4103-X10D5
11mm	4103-X11
11.5mm	4103-X11D5
12mm	4103-X12
12.5mm	4103-X12D5
13mm	4103-X13
13.5mm	4103-X13D5
14mm	4103-X14
14.5mm	4103-X14D5
15mm	4103-X15
15.5mm	4103-X15D5
16mm	4103-X16
16.5mm	4103-X16D5
17mm	4103-X17
17.5mm	4103-X17D5
18mm	4103-X18
18.5mm	4103-X18D5
19mm	4103-X19
19.5mm	4103-X19D5

Size	Code
20mm	4103-X20
20.5mm	4103-X20D5
21mm	4103-X21
21.5mm	4103-X21D5
22mm	4103-X22
22.5mm	4103-X22D5
23mm	4103-X23
23.5mm	4103-X23D5
24mm	4103-X24
24.5mm	4103-X24D5
25mm	4103-X25
30mm	4103-X30
40mm	4103-X40
50mm	4103-X50
60mm	4103-X60
70mm	4103-X70
75mm	4103-X75
80mm	4103-X80
90mm	4103-X90
100mm	4103-X100

STEEL GAUGE BLOCK SETS

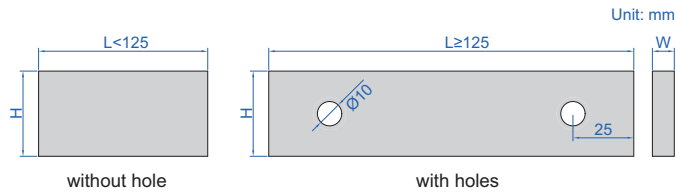

Dimension:

Size (L)	W	H
0.5 ≤ L ≤ 10mm	9mm	30mm
L > 10mm	9mm	35mm

Code example:
"-122" stands for "4100-122"

- Made of alloy steel
- Meet ISO3650
- Gauge blocks ≥ 125mm have clamping holes
- Supplied with manufacturer inspection certificate



POPULAR MODEL

4100-87

Blocks per set	Gauge blocks included in set			Code (4100)		
	Size (mm)	Step (mm)	Quantity	Grade 0	Grade 1	Grade 2
122	1.0005		1			
	1.001-1.009	0.001	9			
	1.01-1.49	0.01	49			
	1.6-1.9	0.1	4	-122	-1122	-2122
	0.5-24.5	0.5	49			
	30-100	10	8			
	25-75	50	2			
112	1.0005		1			
	1.001-1.009	0.001	9			
	1.01-1.49	0.01	49	-112	-1112	-2112
	0.5-24.5	0.5	49			
	25-100	25	4			
103	1.005		1			
	1.01-1.49	0.01	49			
	0.5-24.5	0.5	49	-103	-1103	-2103
	25-100	25	4			
88	1.0005		1			
	1.001-1.009	0.001	9			
	1.01-1.49	0.01	49	-88	-188	-288
	0.5-9.5	0.5	19			
	10-100	10	10			
87	1.001-1.009	0.001	9			
	1.01-1.49	0.01	49			
	0.5-9.5	0.5	19	-87	-187	-287
	10-100	10	10			
83	0.5		1			
	1		1			
	1.005		1			
	1.01-1.49	0.01	49	-83	-183	-283
	1.5-1.9	0.1	5			
	2-9.5	0.5	16			
10-100	10	10				
76	1.005		1			
	1.01-1.49	0.01	49			
	0.5-9.5	0.5	19	-76	-176	-276
	10-40	10	4			
	50-100	25	3			

Blocks per set	Gauge blocks included in set			Code (4100)		
	Size (mm)	Step (mm)	Quantity	Grade 0	Grade 1	Grade 2
56	0.5		1			
	1.001-1.009	0.001	9			
	1.01-1.09	0.01	9	-56	-156	-256
	1.1-1.9	0.1	9			
	1-24	1	24			
	25-100	25	4			
	1.005		1			
47	1.01-1.09	0.01	9			
	1.1-1.9	0.1	9	-47A	-147A	-247A
	1-24	1	24			
	25-100	25	4			
47	1.005		1			
	1.01-1.19	0.01	19			
	1.2-1.9	0.1	8	-47	-147	-247
	1-9	1	9			
	10-100	10	10			
46	1.001-1.009	0.001	9			
	1.01-1.09	0.01	9			
	1.1-1.9	0.1	9	-46	-146	-246
	1-9	1	9			
	10-100	10	10			
34	1.0005		1			
	1.001-1.009	0.001	9			
	1.01-1.09	0.01	9			
	1.1-1.9	0.1	9	-34	-134	-234
	1-5	1	5			
	10		1			
32	1.005		1			
	1.01-1.09	0.01	9			
	1.1-1.9	0.1	9			
	1-9	1	9	-32	-132	-232
	10-30	10	3			
	50		1			
9	1.001-1.009	0.001	9	-9	-19	-29
9	0.991-0.999	0.001	9	-9A	-19A	-29A
8	125-175	25	3			
	200-250	50	2	-8	-18	-28
	300-500	100	3			

CUSTOM-MADE
CAN SUPPLY ANY SIZES FROM
0.5 TO 1000MM, SUCH AS 72.672MM



STEEL INDIVIDUAL GAUGE BLOCKS



4101-A70

4101-A200

Unit: mm

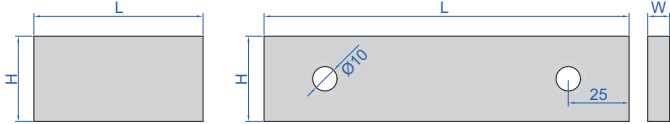

without hole

with holes

- Grade 0, 1 and 2 gauge blocks are available
- Made of alloy steel
- Meet ISO3650
- Gauge blocks with clamping holes: 125, 150, 175, 200, 250, 300, 400, 500, 600, 700, 800, 900, 1000mm
- Supplied with manufacturer inspection certificate

Code explanation:

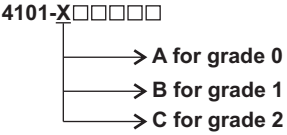

Code examples:

Size (L)	Grade	Code
0.5mm	0	4101-AD5
1mm	1	4101-B1
10.5mm	2	4101-C10D5

Dimension:

Size (L)	W	H
0.5 ≤ L ≤ 10mm	9mm	30mm
L > 10mm	9mm	35mm

Size	Code
0.5mm	4101-XD5
0.991mm	4101-XD991
0.992mm	4101-XD992
0.993mm	4101-XD993
0.994mm	4101-XD994
0.995mm	4101-XD995
0.996mm	4101-XD996
0.997mm	4101-XD997
0.998mm	4101-XD998
0.999mm	4101-XD999
1mm	4101-X1
1.0005mm	4101-X1D0005
1.001mm	4101-X1D001
1.002mm	4101-X1D002
1.003mm	4101-X1D003
1.004mm	4101-X1D004
1.005mm	4101-X1D005
1.006mm	4101-X1D006
1.007mm	4101-X1D007
1.008mm	4101-X1D008
1.009mm	4101-X1D009
1.01mm	4101-X1D01
1.02mm	4101-X1D02
1.03mm	4101-X1D03
1.04mm	4101-X1D04
1.05mm	4101-X1D05
1.06mm	4101-X1D06
1.07mm	4101-X1D07
1.08mm	4101-X1D08
1.09mm	4101-X1D09
1.1mm	4101-X1D1
1.11mm	4101-X1D11
1.12mm	4101-X1D12
1.13mm	4101-X1D13
1.14mm	4101-X1D14
1.15mm	4101-X1D15
1.16mm	4101-X1D16
1.17mm	4101-X1D17
1.18mm	4101-X1D18

Size	Code
1.19mm	4101-X1D19
1.2mm	4101-X1D2
1.21mm	4101-X1D21
1.22mm	4101-X1D22
1.23mm	4101-X1D23
1.24mm	4101-X1D24
1.25mm	4101-X1D25
1.26mm	4101-X1D26
1.27mm	4101-X1D27
1.28mm	4101-X1D28
1.29mm	4101-X1D29
1.3mm	4101-X1D3
1.31mm	4101-X1D31
1.32mm	4101-X1D32
1.33mm	4101-X1D33
1.34mm	4101-X1D34
1.35mm	4101-X1D35
1.36mm	4101-X1D36
1.37mm	4101-X1D37
1.38mm	4101-X1D38
1.39mm	4101-X1D39
1.4mm	4101-X1D4
1.41mm	4101-X1D41
1.42mm	4101-X1D42
1.43mm	4101-X1D43
1.44mm	4101-X1D44
1.45mm	4101-X1D45
1.46mm	4101-X1D46
1.47mm	4101-X1D47
1.48mm	4101-X1D48
1.49mm	4101-X1D49
1.5mm	4101-X1D5
1.6mm	4101-X1D6
1.7mm	4101-X1D7
1.8mm	4101-X1D8
1.9mm	4101-X1D9
2mm	4101-X2
2.5mm	4101-X2D5
3mm	4101-X3

Size	Code
3.5mm	4101-X3D5
4mm	4101-X4
4.5mm	4101-X4D5
5mm	4101-X5
5.1mm	4101-X5D1
5.5mm	4101-X5D5
6mm	4101-X6
6.5mm	4101-X6D5
7mm	4101-X7
7.5mm	4101-X7D5
7.7mm	4101-X7D7
8mm	4101-X8
8.5mm	4101-X8D5
9mm	4101-X9
9.5mm	4101-X9D5
10mm	4101-X10
10.3mm	4101-X10D3
10.5mm	4101-X10D5
11mm	4101-X11
11.5mm	4101-X11D5
12mm	4101-X12
12.5mm	4101-X12D5
12.9mm	4101-X12D9
13mm	4101-X13
13.5mm	4101-X13D5
14mm	4101-X14
14.5mm	4101-X14D5
15mm	4101-X15
15.5mm	4101-X15D5
16mm	4101-X16
16.5mm	4101-X16D5
17mm	4101-X17
17.5mm	4101-X17D5
17.6mm	4101-X17D6
18mm	4101-X18
18.5mm	4101-X18D5
19mm	4101-X19
19.5mm	4101-X19D5
20mm	4101-X20

Size	Code
20.2mm	4101-X20D2
20.5mm	4101-X20D5
21mm	4101-X21
21.5mm	4101-X21D5
22mm	4101-X22
22.5mm	4101-X22D5
22.8mm	4101-X22D8
23mm	4101-X23
23.5mm	4101-X23D5
24mm	4101-X24
24.5mm	4101-X24D5
25mm	4101-X25
30mm	4101-X30
35mm	4101-X35
40mm	4101-X40
41.3mm	4101-X41D3
45mm	4101-X45
50mm	4101-X50
60mm	4101-X60
70mm	4101-X70
75mm	4101-X75
80mm	4101-X80
90mm	4101-X90
100mm	4101-X100
125mm	4101-X125
131.4mm	4101-X131D4
150mm	4101-X150
175mm	4101-X175
200mm	4101-X200
250mm	4101-X250
300mm	4101-X300
400mm	4101-X400
500mm	4101-X500
600mm	4101-X600
700mm	4101-X700
750mm	4101-X750
800mm	4101-X800
900mm	4101-X900
1000mm	4101-X1000

STEEL INDIVIDUAL GAUGE BLOCKS

INSIZE PLUS
MADE IN EUROPE



CUSTOM-MADE
CAN SUPPLY ANY SIZES FROM
0.1 TO 1000MM, SUCH AS 72.672MM



4104-A70



4104-A200

Code explanation:

4104-X□□□□□

- K for grade K
- A for grade 0
- B for grade 1

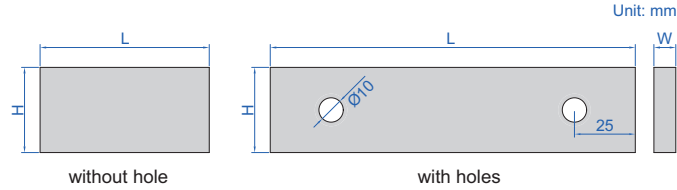

Code examples:

Size (L)	Grade	Code
0.5mm	K	4104-KD5
1mm	0	4104-A1
10.5mm	1	4104-B10D5

Dimension:

Size (L)	W	H
0.5 ≤ L ≤ 10mm	9mm	30mm
L > 10mm	9mm	35mm

- Grade K, 0 and 1 gauge blocks are available
- Made of alloy steel
- Meet ISO3650
- Gauge blocks with clamping holes: 125, 150, 175, 200, 250, 300, 400, 500, 600, 700, 800, 900, 1000mm
- Supplied with manufacturer inspection certificate

Size	Code
0.1mm	4104-XD1
0.2mm	4104-XD2
0.3mm	4104-XD3
0.4mm	4104-XD4
0.5mm	4104-XD5
1mm	4104-X1
1.0005mm	4104-X1D0005
1.001mm	4104-X1D001
1.002mm	4104-X1D002
1.003mm	4104-X1D003
1.004mm	4104-X1D004
1.005mm	4104-X1D005
1.006mm	4104-X1D006
1.007mm	4104-X1D007
1.008mm	4104-X1D008
1.009mm	4104-X1D009
1.01mm	4104-X1D01
1.02mm	4104-X1D02
1.03mm	4104-X1D03
1.04mm	4104-X1D04
1.05mm	4104-X1D05
1.06mm	4104-X1D06
1.07mm	4104-X1D07
1.08mm	4104-X1D08
1.09mm	4104-X1D09
1.1mm	4104-X1D1
1.11mm	4104-X1D11
1.12mm	4104-X1D12
1.13mm	4104-X1D13
1.14mm	4104-X1D14
1.15mm	4104-X1D15
1.16mm	4104-X1D16
1.17mm	4104-X1D17
1.18mm	4104-X1D18
1.19mm	4104-X1D19
1.2mm	4104-X1D2

Size	Code
1.21mm	4104-X1D21
1.22mm	4104-X1D22
1.23mm	4104-X1D23
1.24mm	4104-X1D24
1.25mm	4104-X1D25
1.26mm	4104-X1D26
1.27mm	4104-X1D27
1.28mm	4104-X1D28
1.29mm	4104-X1D29
1.3mm	4104-X1D3
1.31mm	4104-X1D31
1.32mm	4104-X1D32
1.33mm	4104-X1D33
1.34mm	4104-X1D34
1.35mm	4104-X1D35
1.36mm	4104-X1D36
1.37mm	4104-X1D37
1.38mm	4104-X1D38
1.39mm	4104-X1D39
1.4mm	4104-X1D4
1.41mm	4104-X1D41
1.42mm	4104-X1D42
1.43mm	4104-X1D43
1.44mm	4104-X1D44
1.45mm	4104-X1D45
1.46mm	4104-X1D46
1.47mm	4104-X1D47
1.48mm	4104-X1D48
1.49mm	4104-X1D49
1.5mm	4104-X1D5
1.6mm	4104-X1D6
1.7mm	4104-X1D7
1.8mm	4104-X1D8
1.9mm	4104-X1D9
2mm	4104-X2
2.5mm	4104-X2D5

Size	Code
3mm	4104-X3
3.5mm	4104-X3D5
4mm	4104-X4
4.5mm	4104-X4D5
5mm	4104-X5
5.5mm	4104-X5D5
6mm	4104-X6
6.5mm	4104-X6D5
7mm	4104-X7
7.5mm	4104-X7D5
8mm	4104-X8
8.5mm	4104-X8D5
9mm	4104-X9
9.5mm	4104-X9D5
10mm	4104-X10
10.5mm	4104-X10D5
11mm	4104-X11
11.5mm	4104-X11D5
12mm	4104-X12
12.5mm	4104-X12D5
13mm	4104-X13
13.5mm	4104-X13D5
14mm	4104-X14
14.5mm	4104-X14D5
15mm	4104-X15
15.5mm	4104-X15D5
16mm	4104-X16
16.5mm	4104-X16D5
17mm	4104-X17
17.5mm	4104-X17D5
18mm	4104-X18
18.5mm	4104-X18D5
19mm	4104-X19
19.5mm	4104-X19D5
20mm	4104-X20
20.5mm	4104-X20D5

Size	Code
21mm	4104-X21
21.5mm	4104-X21D5
22mm	4104-X22
22.5mm	4104-X22D5
23mm	4104-X23
23.5mm	4104-X23D5
24mm	4104-X24
24.5mm	4104-X24D5
25mm	4104-X25
30mm	4104-X30
40mm	4104-X40
50mm	4104-X50
60mm	4104-X60
70mm	4104-X70
75mm	4104-X75
80mm	4104-X80
90mm	4104-X90
100mm	4104-X100
125mm	4104-X125
131.4mm	4104-X131D4
150mm	4104-X150
175mm	4104-X175
200mm	4104-X200
243.5mm	4104-X243D5
250mm	4104-X250
281.2mm	4104-X281D2
300mm	4104-X300
400mm	4104-X400
481.1mm	4104-X481D1
500mm	4104-X500
550mm	4104-X550
600mm	4104-X600
700mm	4104-X700
800mm	4104-X800
900mm	4104-X900
1000mm	4104-X1000



CARBIDE GAUGE BLOCK SETS



4164-32

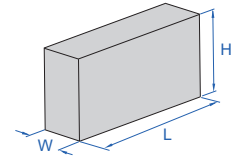

- Made of carbide, extremely wear resistance and corrosion resistance, excellent dimension stability
- Meet ISO3650
- Supplied with manufacturer inspection certificate

Dimension:

Size (L)	W	H
0.5 ≤ L ≤ 10mm	9mm	30mm
L > 10mm	9mm	35mm

Blocks per set	Gauge blocks included in set			Code	
	Size (mm)	Step (mm)	Quantity	Grade 0	Grade 1
122	1.0005		1	4164-122	4164-1122
	1.001-1.009	0.001	9		
	1.01-1.49	0.01	49		
	1.6-1.9	0.1	4		
	0.5-24.5	0.5	49		
	30-100	10	8		
	25-75	50	2		
112	1.0005		1	4164-112	4164-1112
	1.001-1.009	0.001	9		
	1.01-1.49	0.01	49		
	0.5-24.5	0.5	49		
	25-100	25	4		
103	1.005		1	4164-103	4164-1103
	1.01-1.49	0.01	49		
	0.5-24.5	0.5	49		
	25-100	25	4		
87	1.001-1.009	0.001	9	4164-87	4164-187
	1.01-1.49	0.01	49		
	0.5-9.5	0.5	19		
	10-100	10	10		
83	0.5		1	4164-83	4164-183
	1		1		
	1.005		1		
	1.01-1.49	0.01	49		
	1.5-1.9	0.1	5		
	2-9.5	0.5	16		
	10-100	10	10		

Blocks per set	Gauge blocks included in set			Code	
	Size (mm)	Step (mm)	Quantity	Grade 0	Grade 1
76	1.005		1	4164-76	4164-176
	1.01-1.49	0.01	49		
	0.5-9.5	0.5	19		
	10-40	10	4		
	50-100	25	3		
47	1.005		1	4164-47A	4164-147A
	1.01-1.09	0.01	9		
	1.1-1.9	0.1	9		
	1-24	1	24		
47	1.005		1	4164-47	4164-147
	1.01-1.19	0.01	19		
	1.2-1.9	0.1	8		
	1-9	1	9		
	10-100	10	10		
46	1.001-1.009	0.001	9	4164-46	4164-146
	1.01-1.09	0.01	9		
	1.1-1.9	0.1	9		
	1-9	1	9		
	10-100	10	10		
32	1.005		1	4164-32	4164-132
	1.01-1.09	0.01	9		
	1.1-1.9	0.1	9		
	1-9	1	9		
	10-30	10	3		
	50		1		

CALIPER INSPECTION GAUGE BLOCK SET



4108-3005

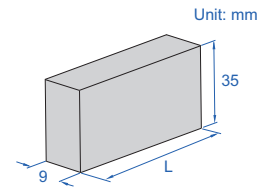

- Meet ISO3650/grade 2
- Supplied with manufacturer inspection certificate

Code	Material	Gauge blocks included in set (L)	Applicable calipers
4108-3005	alloy steel	30, 41.3, 131.4, 243.5, 281.2	0-150, 0-200, 0-300

(mm)

CALIPER INSPECTION GAUGE BLOCK AND RING GAUGE SETS



12

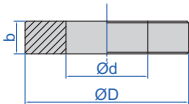

Ring gauge sizes:

diameter (Ød) *	b	ØD
Ø10mm	8mm	32mm
Ø25mm	14mm	53mm

* The size of the ring gauge actually supplied may have deviation. For example, the size Ø25mm may be 24.996mm



4176-30

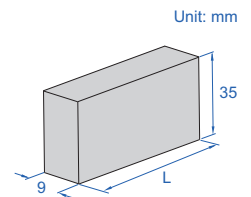

- Gauge blocks meet ISO3650, ring gauges meet DIN2250-1:2008
- Supplied with manufacturer inspection certificate

Grade of gauge blocks: 2

(mm)

Code	Material	Gauge blocks included in set (L)	Ring gauges included in set (Ød)	Applicable calipers
4176-30	alloy steel	30, 41.3, 131.4	10, 25	0-150

Grade of gauge blocks: 1

(mm)

Code	Material	Gauge blocks included in set (L)	Ring gauges included in set (Ød)	Applicable calipers
4176-301	alloy steel	30, 41.3, 131.4	10, 25	0-150

MICROMETER INSPECTION GAUGE BLOCK SETS



4107-10

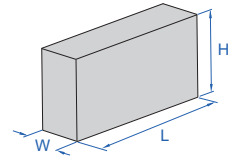

Dimension:

Size (L)	W	H
$0.5 \leq L \leq 10\text{mm}$	9mm	30mm
$L > 10\text{mm}$	9mm	35mm

- One piece of optical flat is included in 4107-10 and 4107-101
- Meet ISO3650/grade 0
- Supplied with manufacturer inspection certificate

Code	Material	Gauge blocks included in set (mm)	Applicable micrometer	Optical flat
4107-10	ceramic	2.5, 5.1, 7.7, 10.3, 12.9, 15, 17.6, 20.2, 22.8, 25, optical flat	0-25mm	included
4107-101	alloy steel	2.5, 5.1, 7.7, 10.3, 12.9, 15, 17.6, 20.2, 22.8, 25, optical flat	0-25mm	included
4107-112	alloy steel	25, 27.5, 30.1, 32.7, 35.3, 37.9, 40, 42.6, 45.2, 47.8, 50	25-50mm	not included
4107-113	alloy steel	50, 52.5, 55.1, 57.7, 60.3, 62.9, 65, 67.6, 70.2, 72.8, 75	50-75mm	not included
4107-114	alloy steel	75, 77.5, 80.1, 82.7, 85.3, 87.9, 90, 92.6, 95.2, 97.8, 100	75-100mm	not included
4107-115	alloy steel	5.12, 10.24, 15.36, 21.5, 25, 30.12, 35.24, 40.36, 46.5, 50, 55.12, 60.24, 65.36, 71.5, 75, 80.12, 85.24, 90.36, 96.5, 100	0-100mm	not included

MICROMETER INSPECTION GAUGE BLOCK SET

application



4160-10

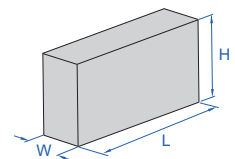

Dimension:

Size (L)	W	H
$0.5 \leq L \leq 10\text{mm}$	9mm	30mm
$L > 10\text{mm}$	9mm	35mm

- Meet ISO3650/grade 0
- One piece of optical flat is included (size $\varnothing 30 \times 12\text{mm}$)
- Supplied with manufacturer inspection certificate

Code	Material	Gauge blocks included in set	Applicable micrometer
4160-10	alloy steel	2.5mm, 5.1mm, 7.7mm, 10.3mm, 12.9mm, 15mm, 17.6mm, 20.2mm, 22.8mm, 25mm	0-25mm

optical flat (included)



CYLINDER GAUGE BLOCKS

CUSTOM-MADE
CAN SUPPLY ANY LENGTH, SUCH AS 80.672MM

INSPECTION
CERTIFICATE

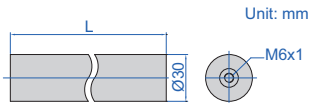

- Made of special alloy steel, hardness HRC64, high stability, wear resistance and easy combination
- Meet ISO3650 grade 1
- Can be connected with M6x1 screw and combined to any sizes up to 4m

can be combined to any sizes up to 4m

Combination 1: combined by several standard size cylinder gauge blocks and one custom size cylinder gauge block
For example: 500 (standard) + 200 (standard) + 25.832 (custom)=725.832mm
Note: in order to reduce cost, custom size should be within 100mm

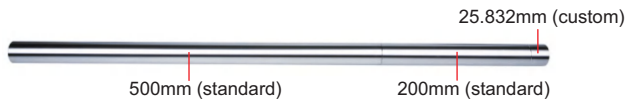

Combination 2: combined by standard size cylinder gauge blocks and rectangular gauge blocks
For example: 500 (cylinder) + 200 (cylinder) + 21.5 (rectangular) + 2.33 (rectangular) + 2.002 (rectangular)=725.832mm

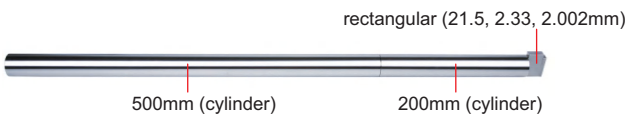

Code	Length (L)
4001-25 *	25mm
4001-50 *	50mm
4001-75 *	75mm
4001-100 *	100mm
4001-200 *	200mm
4001-300 *	300mm
4001-400 *	400mm
4001-500 *	500mm

* Supplied with manufacturer inspection certificate

high stability in vertical position,
suitable for checking height gauges



connected with M6x1mm screw

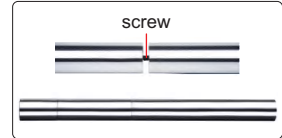

INTERNAL BLOCKS

12

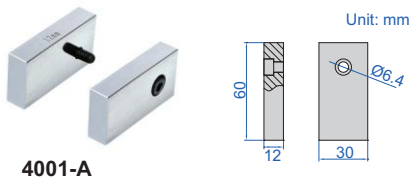

4001-A

- Can be attached to cylinder and rectangular gauge blocks
- Made of special alloy steel, hardness HRC64, high stability, wear resistance and easy combination
- Supplied in a matched pair

Code	Size	Flatness
4001-A	12mm	0.2µm

Combination 1: combined by several standard size cylinder gauge blocks and one custom size cylinder gauge block
For example: 500 (standard) + 200 (standard) + 25.832 (custom)=725.832mm
Note: in order to reduce cost, custom size should be within 100mm

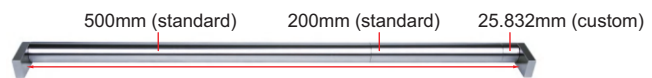

Combination 2: combined by standard size cylinder gauge blocks and rectangular gauge blocks
For example: 500 (cylinder) + 200 (cylinder) + 50 (rectangular) - 20 (rectangular) - 2.16 (rectangular) - 2.008 (rectangular)=725.832mm

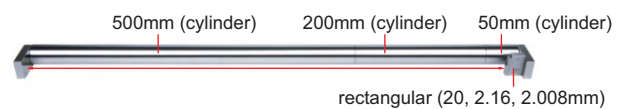

BASE

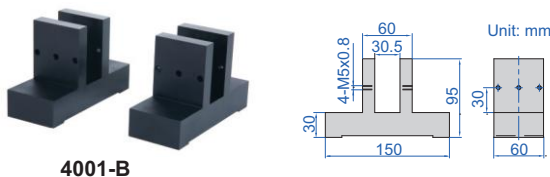

4001-B

Code	Remark
4001-B	supplied in pair

working with base

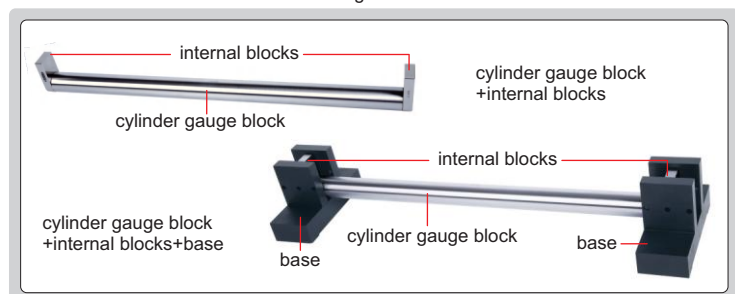

GAUGE BLOCK ACCESSORIES

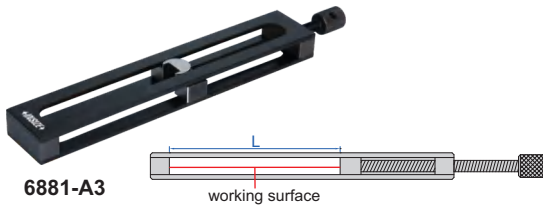

6881-A3

Code	Name	Clamping range* (L)
6881-A1	holder	3.5-29mm
6881-A2	holder	29-50mm
6881-A3	holder	50-100mm
6881-A4	holder	100-200mm
6881-A5	holder	200-300mm
6881-A6**	holder	300-500mm
6881-A7**	holder	500-750mm
6881-A8**	holder	750-1000mm

*The actual clamping range should deduct the width of jaws
 ** Not suitable for base 6881-B

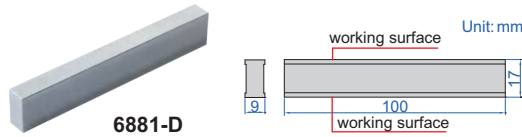

6881-D

Code	Name	Remark
6881-D	parallel jaw	made of carbide



6881-S17

GAUGE BLOCK ACCESSORY SET

Code	Remark
6881-S17	17 pcs (including below items)

holder, 0-25mm (code 6881-A1)	1 pc
holder, 25-50mm (code 6881-A2)	1 pc
holder, 50-100mm (code 6881-A3)	1 pc
holder, 100-200mm (code 6881-A4)	1 pc
holder, 200-300mm (code 6881-A5)	1 pc
base (code 6881-B)	1 pc
plain jaw (code 6881-C)	1 pair
parallel jaw (code 6881-D)	1 pc
half round jaw, 2.5mm (code 6881-E1)	1 pair
half round jaw, 5.0mm (code 6881-E2)	1 pair
half round jaw, 6.0mm (code 6881-E3)	1 pair
scraper (code 6881-F)	1 pc
centre point (code 6881-G)	1 pc



6881-B

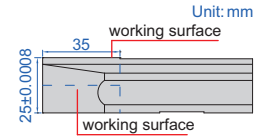

6881-E2

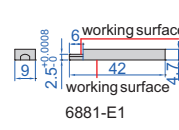

6881-E1

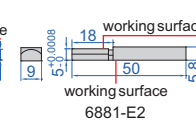

6881-E2

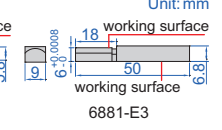

6881-E3

Code	Name	Size	Remark
6881-E1	half round jaw	2.5mm	made of carbide, supplied in pair
6881-E2	half round jaw	5.0mm	made of carbide, supplied in pair
6881-E3	half round jaw	6.0mm	made of carbide, supplied in pair



6881-C

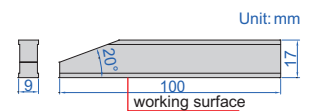

Code	Name	Remark
6881-C	plain jaw	made of carbide, supplied in pair



6881-F

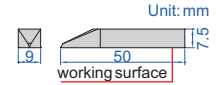

Code	Name	Remark
6881-F	scraper	made of carbide

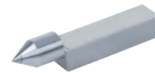

6881-G

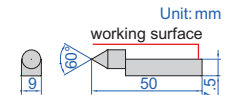

Code	Name	Remark
6881-G	centre point	the tip is made of carbide

application

<p>(plain jaw+holder) set zero for bore gauge and inside micrometers</p>	<p>(base+holder+scraper) measure height or scribe</p>	<p>(half round jaw+holder) measure inside diameter</p>
<p>(scraper+centre point+holder) scribe circle</p>	<p>(plain jaw+parallel jaw+holder) Go and No Go inspection</p>	

GAUGE BLOCK HOLDERS



6883-4

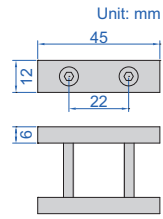

- Made of aluminum
- To be used with individual steel gauge blocks (code 4101) as Go and No-Go gauge

Code	Applicable gauge block size
6883-1	1.5-5mm
6883-2	5-10mm
6883-3	10-15mm
6883-4	15-20mm
6883-5	20-25mm

to be used as Go and No-Go gauge



GAUGE BLOCK HOLDER



6886-1

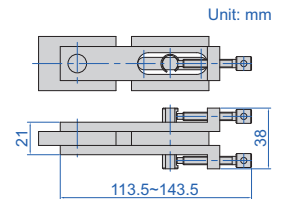

- For gauge blocks over 125mm with clamping holes
- Optional accessory: gauge block holder accessory, gauge block accessory (code 6881)

Code

6886-1

application

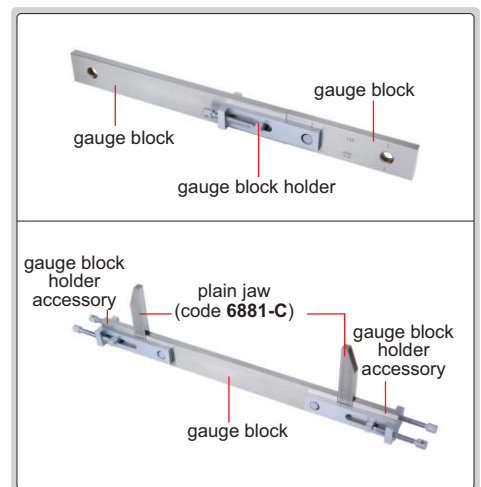

GAUGE BLOCK HOLDER ACCESSORY



6886-A

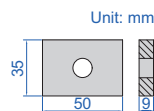

Code

6886-A

CALIPER/HEIGHT GAUGE CHECKERS

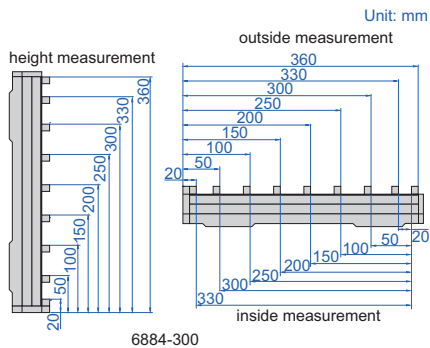

6884-300

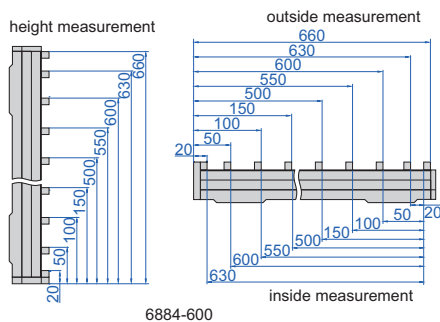

- To check calipers and height gauges
- Constructed with steel gauge blocks

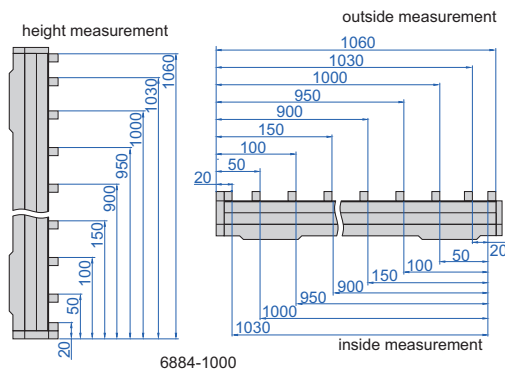

check upper jaws of calipers

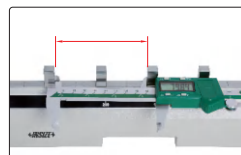

check lower jaws of calipers

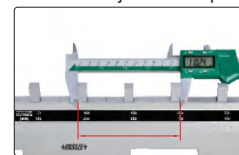

check height gauges

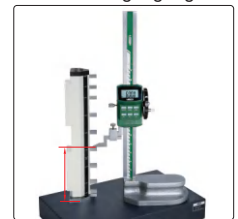

Code	Size	Range of inside measurement	Range of outside measurement	Range of height measurement	Accuracy
6884-300*	0-300mm	20, 50, 100, 150, 200, 250, 300, 330	20, 50, 100, 150, 200, 250, 300, 330, 360	20, 50, 100, 150, 200, 250, 300, 330, 360	±3µm
6884-600*	0-600mm	20, 50, 100, 150, 200, 250, 300, 350, 400, 450, 500, 550, 600, 630	20, 50, 100, 150, 200, 250, 300, 350, 400, 450, 500, 550, 600, 630, 660	20, 50, 100, 150, 200, 250, 300, 350, 400, 450, 500, 550, 600, 630, 660	±5µm
6884-1000*	0-1000mm	20, 50, 100, 150, 200, 250, 300, 350, 400, 450, 500, 550, 600, 650, 700, 750, 800, 850, 900, 950, 1000, 1030	20, 50, 100, 150, 200, 250, 300, 350, 400, 450, 500, 550, 600, 650, 700, 750, 800, 850, 900, 950, 1000, 1030, 1060	20, 50, 100, 150, 200, 250, 300, 350, 400, 450, 500, 550, 600, 650, 700, 750, 800, 850, 900, 950, 1000, 1030, 1060	±7µm

INSIDE MICROMETER ACCESSORY

- Supplied with a pair of 5mm carbide gauge blocks

Code

6884-A10*

* Supplied with manufacturer inspection certificate



6884-A10

set inside micrometers

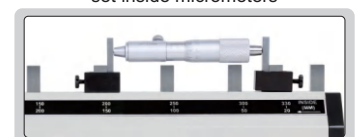

ANGLE GAUGE BLOCKS



4002-15

- Accuracy: $\pm 2''$
- To inspect protractor, taper gauge, index plate, index head and goniometer, can also be used to set angle
- Made of special alloy steel, hardness HRC64, high stability, wear resistance and easy combination
- Can be combined to any angle with interval 6 seconds after combination (6", 12", 18", ... , 360°)

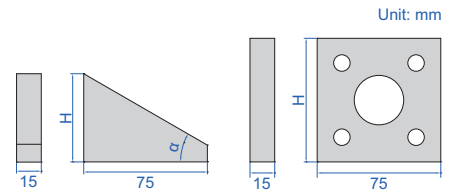

Individual

Code	Angle (α)	H (mm)
4002-A1 *	1°	11.5
4002-A3 *	3°	14.0
4002-A5 *	5°	16.5
4002-A9 *	9°	22.0
4002-A15 *	15°	30.5
4002-A27 *	27°	48.0
4002-A30 *	30°	53.5
4002-A41 *	41°	75.0
4002-A45 *	45°	84.0
4002-B1 *	1'	10.0
4002-B3 *	3'	10.0
4002-B5 *	5'	10.0
4002-B9 *	9'	10.0
4002-B20 *	20'	10.0
4002-B27 *	27'	10.0
4002-B30 *	30'	10.0
4002-C6 *	6"	10.0
4002-C12 *	12"	10.0
4002-C18 *	18"	10.0
4002-C30 *	30"	10.0
4002-D *	90°/90°/90°/90°	75.0

combination

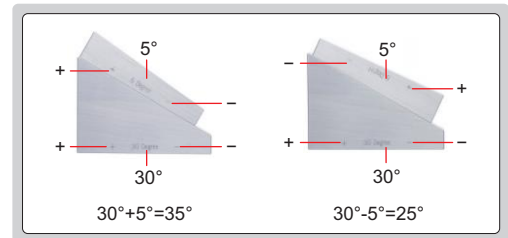

set angle of plate



inspect angle

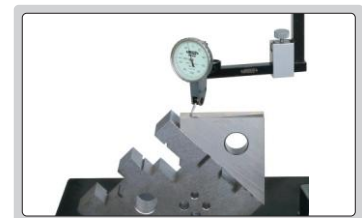

Set

Code	Angle (α)	Total quantity
4002-13 *	1°, 3°, 9°, 27°, 41°, 1', 3', 9', 27', 6", 18", 30", 90°/90°/90°/90°	13
4002-15 *	1°, 3°, 5°, 15°, 30°, 45°, 1', 3', 5', 20', 30', 6", 12", 30", 90°/90°/90°/90°	15

* Supplied with manufacturer inspection certificate

ANGLE BLOCK SET

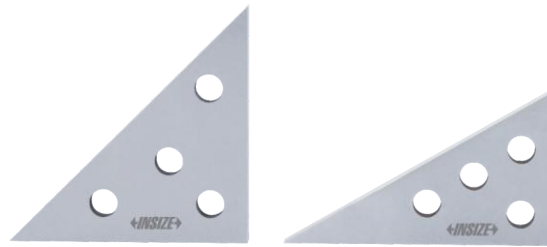

6540-1

- For angle set-up in tooling, production and inspection
- Accuracy of angle: ± 9 seconds
- Made of alloy steel
- Hardness HRC60 ± 2

Code	Angle plates included	Angle
6540-1	2	45°, 45°, 90°
		30°, 60°, 90°

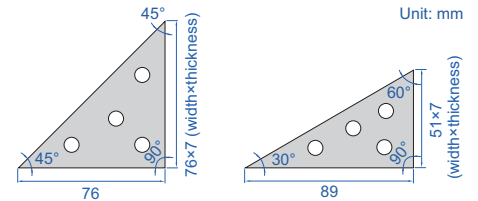

CARBIDE PIN GAUGE SETS

- Meet DIN2269, grade 1
- Made of carbide
- Hardness HRA90-90.5
- Diameter accuracy: $\pm 1\mu\text{m}$



4194-10D

Code	Diameter $\varnothing d$ (mm)	Step	Pin gauges per set
4194-1S	0.30, 0.31, 0.32, ..., 1.00	0.01mm	71
4194-2S	1.00, 1.01, 1.02, ..., 2.00	0.01mm	101
4194-3S	2.00, 2.01, 2.02, ..., 3.00	0.01mm	101
4194-4S	3.00, 3.01, 3.02, ..., 4.00	0.01mm	101
4194-5S	4.00, 4.01, 4.02, ..., 5.00	0.01mm	101
4194-6S	5.00, 5.01, 5.02, ..., 6.00	0.01mm	101
4194-7S	6.00, 6.01, 6.02, ..., 7.00	0.01mm	101
4194-8S	7.00, 7.01, 7.02, ..., 8.00	0.01mm	101
4194-9S	8.00, 8.01, 8.02, ..., 9.00	0.01mm	101
4194-10S	9.00, 9.01, 9.02, ..., 10.00	0.01mm	101
4194-10D	10.00, 10.01, 10.02, ..., 10.50	0.01mm	51
4194-11	10.50, 10.51, 10.52, ..., 11.00	0.01mm	51
4194-11D	11.00, 11.01, 11.02, ..., 11.50	0.01mm	51
4194-12	11.50, 11.51, 11.52, ..., 12.00	0.01mm	51
4194-12D	12.00, 12.01, 12.02, ..., 12.50	0.01mm	51
4194-13	12.50, 12.51, 12.52, ..., 13.00	0.01mm	51
4194-13D	13.00, 13.01, 13.02, ..., 13.50	0.01mm	51
4194-14	13.50, 13.51, 13.52, ..., 14.00	0.01mm	51
4194-14D	14.00, 14.01, 14.02, ..., 14.50	0.01mm	51
4194-15	14.50, 14.51, 14.52, ..., 15.00	0.01mm	51

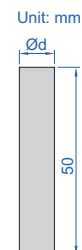

STEEL PIN GAUGE SETS

POPULAR MODEL

- Meet DIN2269, grade 1
- Made of alloy steel
- Hardness HRC62-65
- Diameter accuracy: $\pm 1\mu\text{m}$

Unit: mm

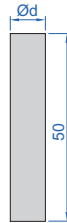

4166-10

Code	Diameter Ød (mm)	Step	Pin gauges per set
4166-2S	1.00, 1.01, 1.02, ..., 2.00	0.01mm	101
4166-3S	2.00, 2.01, 2.02, ..., 3.00	0.01mm	101
4166-4S	3.00, 3.01, 3.02, ..., 4.00	0.01mm	101
4166-5S	4.00, 4.01, 4.02, ..., 5.00	0.01mm	101
4166-6S	5.00, 5.01, 5.02, ..., 6.00	0.01mm	101
4166-7S	6.00, 6.01, 6.02, ..., 7.00	0.01mm	101
4166-8S	7.00, 7.01, 7.02, ..., 8.00	0.01mm	101
4166-9S	8.00, 8.01, 8.02, ..., 9.00	0.01mm	101
4166-10S	9.00, 9.01, 9.02, ..., 10.00	0.01mm	101

Code	Diameter Ød (mm)	Step	Pin gauges per set
4166-411	1.0, 1.1, 1.2, ..., 5.0	0.1mm	41
4166-511	5.0, 5.1, 5.2, ..., 10.0	0.1mm	51
4166-512	10.0, 10.1, 10.2, ..., 15.0	0.1mm	51
4166-513	15.0, 15.1, 15.2, ..., 20.0	0.1mm	51

Code	Diameter Ød (mm)	Step	Pin gauges per set
4166-0D	0.20, 0.21, 0.22, ..., 0.50	0.01mm	31
4166-1	0.50, 0.51, 0.52, ..., 1.00	0.01mm	51
4166-1D	1.00, 1.01, 1.02, ..., 1.50	0.01mm	51
4166-2	1.50, 1.51, 1.52, ..., 2.00	0.01mm	51
4166-2D	2.00, 2.01, 2.02, ..., 2.50	0.01mm	51
4166-3	2.50, 2.51, 2.52, ..., 3.00	0.01mm	51
4166-3D	3.00, 3.01, 3.02, ..., 3.50	0.01mm	51
4166-4	3.50, 3.51, 3.52, ..., 4.00	0.01mm	51
4166-4D	4.00, 4.01, 4.02, ..., 4.50	0.01mm	51
4166-5	4.50, 4.51, 4.52, ..., 5.00	0.01mm	51
4166-5D	5.00, 5.01, 5.02, ..., 5.50	0.01mm	51
4166-6	5.50, 5.51, 5.52, ..., 6.00	0.01mm	51
4166-6D	6.00, 6.01, 6.02, ..., 6.50	0.01mm	51
4166-7	6.50, 6.51, 6.52, ..., 7.00	0.01mm	51
4166-7D	7.00, 7.01, 7.02, ..., 7.50	0.01mm	51
4166-8	7.50, 7.51, 7.52, ..., 8.00	0.01mm	51
4166-8D	8.00, 8.01, 8.02, ..., 8.50	0.01mm	51
4166-9	8.50, 8.51, 8.52, ..., 9.00	0.01mm	51
4166-9D	9.00, 9.01, 9.02, ..., 9.50	0.01mm	51
4166-10	9.50, 9.51, 9.52, ..., 10.00	0.01mm	51

Code	Diameter Ød (mm)	Step	Pin gauges per set
4166-10D	10.00, 10.01, 10.02, ..., 10.50	0.01mm	51
4166-11	10.50, 10.51, 10.52, ..., 11.00	0.01mm	51
4166-11D	11.00, 11.01, 11.02, ..., 11.50	0.01mm	51
4166-12	11.50, 11.51, 11.52, ..., 12.00	0.01mm	51
4166-12D	12.00, 12.01, 12.02, ..., 12.50	0.01mm	51
4166-13	12.50, 12.51, 12.52, ..., 13.00	0.01mm	51
4166-13D	13.00, 13.01, 13.02, ..., 13.50	0.01mm	51
4166-14	13.50, 13.51, 13.52, ..., 14.00	0.01mm	51
4166-14D	14.00, 14.01, 14.02, ..., 14.50	0.01mm	51
4166-15	14.50, 14.51, 14.52, ..., 15.00	0.01mm	51
4166-15D	15.00, 15.01, 15.02, ..., 15.50	0.01mm	51
4166-16	15.50, 15.51, 15.52, ..., 16.00	0.01mm	51
4166-16D	16.00, 16.01, 16.02, ..., 16.50	0.01mm	51
4166-17	16.50, 16.51, 16.52, ..., 17.00	0.01mm	51
4166-17D	17.00, 17.01, 17.02, ..., 17.50	0.01mm	51
4166-18	17.50, 17.51, 17.52, ..., 18.00	0.01mm	51
4166-18D	18.00, 18.01, 18.02, ..., 18.50	0.01mm	51
4166-19	18.50, 18.51, 18.52, ..., 19.00	0.01mm	51
4166-19D	19.00, 19.01, 19.02, ..., 19.50	0.01mm	51
4166-20	19.50, 19.51, 19.52, ..., 20.00	0.01mm	51

CERAMIC PIN GAUGE SETS



Unit: mm

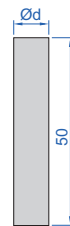

- Meet DIN2269, grade 1
- Made of ceramic, extremely wear resistance, corrosion resistance and dimensional stability
- Diameter accuracy: $\pm 1\mu\text{m}$

4169-3

Code	Diameter $\varnothing d$ (mm)	Step	Pin gauges per set
4169-2S	1.00, 1.01, 1.02, ..., 2.00	0.01mm	101
4169-3S	2.00, 2.01, 2.02, ..., 3.00	0.01mm	101
4169-4S	3.00, 3.01, 3.02, ..., 4.00	0.01mm	101
4169-5S	4.00, 4.01, 4.02, ..., 5.00	0.01mm	101
4169-6S	5.00, 5.01, 5.02, ..., 6.00	0.01mm	101
4169-7S	6.00, 6.01, 6.02, ..., 7.00	0.01mm	101
4169-8S	7.00, 7.01, 7.02, ..., 8.00	0.01mm	101
4169-9S	8.00, 8.01, 8.02, ..., 9.00	0.01mm	101
4169-10S	9.00, 9.01, 9.02, ..., 10.00	0.01mm	101

Code	Diameter $\varnothing d$ (mm)	Step	Pin gauges per set
4169-411	1.0, 1.1, 1.2, ..., 5.0	0.1mm	41
4169-511	5.0, 5.1, 5.2, ..., 10.0	0.1mm	51
4169-512	10.0, 10.1, 10.2, ..., 15.0	0.1mm	51
4169-513	15.0, 15.1, 15.2, ..., 20.0	0.1mm	51

Code	Diameter $\varnothing d$ (mm)	Step	Pin gauges per set
4169-0D	0.30, 0.31, 0.32, ..., 0.50	0.01mm	21
4169-1	0.50, 0.51, 0.52, ..., 1.00	0.01mm	51
4169-1D	1.00, 1.01, 1.02, ..., 1.50	0.01mm	51
4169-2	1.50, 1.51, 1.52, ..., 2.00	0.01mm	51
4169-2D	2.00, 2.01, 2.02, ..., 2.50	0.01mm	51
4169-3	2.50, 2.51, 2.52, ..., 3.00	0.01mm	51
4169-3D	3.00, 3.01, 3.02, ..., 3.50	0.01mm	51
4169-4	3.50, 3.51, 3.52, ..., 4.00	0.01mm	51
4169-4D	4.00, 4.01, 4.02, ..., 4.50	0.01mm	51
4169-5	4.50, 4.51, 4.52, ..., 5.00	0.01mm	51
4169-5D	5.00, 5.01, 5.02, ..., 5.50	0.01mm	51
4169-6	5.50, 5.51, 5.52, ..., 6.00	0.01mm	51
4169-6D	6.00, 6.01, 6.02, ..., 6.50	0.01mm	51
4169-7	6.50, 6.51, 6.52, ..., 7.00	0.01mm	51
4169-7D	7.00, 7.01, 7.02, ..., 7.50	0.01mm	51
4169-8	7.50, 7.51, 7.52, ..., 8.00	0.01mm	51
4169-8D	8.00, 8.01, 8.02, ..., 8.50	0.01mm	51
4169-9	8.50, 8.51, 8.52, ..., 9.00	0.01mm	51
4169-9D	9.00, 9.01, 9.02, ..., 9.50	0.01mm	51
4169-10	9.50, 9.51, 9.52, ..., 10.00	0.01mm	51

Code	Diameter $\varnothing d$ (mm)	Step	Pin gauges per set
4169-10D	10.00, 10.01, 10.02, ..., 10.50	0.01mm	51
4169-11	10.50, 10.51, 10.52, ..., 11.00	0.01mm	51
4169-11D	11.00, 11.01, 11.02, ..., 11.50	0.01mm	51
4169-12	11.50, 11.51, 11.52, ..., 12.00	0.01mm	51
4169-12D	12.00, 12.01, 12.02, ..., 12.50	0.01mm	51
4169-13	12.50, 12.51, 12.52, ..., 13.00	0.01mm	51
4169-13D	13.00, 13.01, 13.02, ..., 13.50	0.01mm	51
4169-14	13.50, 13.51, 13.52, ..., 14.00	0.01mm	51
4169-14D	14.00, 14.01, 14.02, ..., 14.50	0.01mm	51
4169-15	14.50, 14.51, 14.52, ..., 15.00	0.01mm	51
4169-15D	15.00, 15.01, 15.02, ..., 15.50	0.01mm	51
4169-16	15.50, 15.51, 15.52, ..., 16.00	0.01mm	51
4169-16D	16.00, 16.01, 16.02, ..., 16.50	0.01mm	51
4169-17	16.50, 16.51, 16.52, ..., 17.00	0.01mm	51
4169-17D	17.00, 17.01, 17.02, ..., 17.50	0.01mm	51
4169-18	17.50, 17.51, 17.52, ..., 18.00	0.01mm	51
4169-18D	18.00, 18.01, 18.02, ..., 18.50	0.01mm	51
4169-19	18.50, 18.51, 18.52, ..., 19.00	0.01mm	51
4169-19D	19.00, 19.01, 19.02, ..., 19.50	0.01mm	51
4169-20	19.50, 19.51, 19.52, ..., 20.00	0.01mm	51

CARBIDE INDIVIDUAL PIN GAUGES



- Meet DIN2269, grade 1
- Diameter range: $\varnothing 0.300\text{--}\varnothing 30.000\text{mm}$ with three decimal, for example 0.311mm, 5.562mm, 16.298mm
- Diameter accuracy: $\pm 1\mu\text{m}$
- Made of carbide
- Hardness HRA90-90.5

Code	Diameter range $\varnothing d$ (mm)
4193-□□□□*	0.300~30.000

*Supplied with manufacturer inspection certificate



Ordering examples:

Diameter	Code
0.311mm	4193-0D311
5.562mm	4193-5D562
16.298mm	4193-16D298

Note: "D" stands for "."

STEEL INDIVIDUAL PIN GAUGES WITH TWO DECIMAL PLACES (0.01MM STEP)

Ordering examples:

Diameter	Code
0.21mm	4110-0D21
5.56mm	4110-5D56
16.00mm	4110-16D00

Note: "D" stands for "."



- Meet DIN2269, grade 1
- Diameter range: $\varnothing 0.20\text{--}\varnothing 20.00\text{mm}$
- Diameter accuracy: $\pm 1\mu\text{m}$
- Made of alloy steel
- Hardness HRC62-65

Code
4110-□□□□

Diameter $\varnothing d$ (mm)
0.20, 0.21, 0.22, 0.23, ... 1.00
1.01, 1.02, 1.03, 1.04, ... 2.00
2.01, 2.02, 2.03, 2.04, ... 3.00
3.01, 3.02, 3.03, 3.04, ... 4.00
4.01, 4.02, 4.03, 4.04, ... 5.00
5.01, 5.02, 5.03, 5.04, ... 6.00
6.01, 6.02, 6.03, 6.04, ... 7.00
7.01, 7.02, 7.03, 7.04, ... 8.00
8.01, 8.02, 8.03, 8.04, ... 9.00
9.01, 9.02, 9.03, 9.04, ... 10.00
10.01, 10.02, 10.03, 10.04, ... 11.00
11.01, 11.02, 11.03, 11.04, ... 12.00
12.01, 12.02, 12.03, 12.04, ... 13.00
13.01, 13.02, 13.03, 13.04, ... 14.00
14.01, 14.02, 14.03, 14.04, ... 15.00
15.01, 15.02, 15.03, 15.04, ... 16.00
16.01, 16.02, 16.03, 16.04, ... 17.00
17.01, 17.02, 17.03, 17.04, ... 18.00
18.01, 18.02, 18.03, 18.04, ... 19.00
19.01, 19.02, 19.03, 19.04, ... 20.00

STEEL INDIVIDUAL PIN GAUGES WITH THREE DECIMAL PLACES (0.001MM STEP)



- Meet DIN2269, grade 1
- Diameter range: $\varnothing 0.200\text{--}\varnothing 30.000\text{mm}$ with three decimal, for example 0.211mm, 5.562mm, 16.298mm
- Diameter accuracy: $\pm 1\mu\text{m}$
- Made of alloy steel
- Hardness HRC62-65

Code	Diameter range $\varnothing d$ (mm)
4118-□□□□*	0.200~30.000

*Supplied with manufacturer inspection certificate

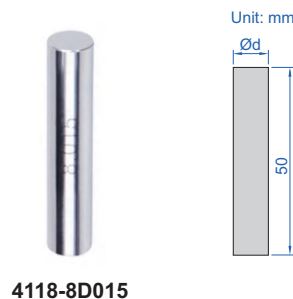

Ordering examples:

Diameter	Code
0.211mm	4118-0D211
5.562mm	4118-5D562
16.298mm	4118-16D298

Note: "D" stands for "."

CERAMIC INDIVIDUAL PIN GAUGES WITH TWO DECIMAL PLACES (0.01MM STEP)

- Meet DIN2269, grade 1
- Diameter range: $\varnothing 0.30\sim\varnothing 20.00\text{mm}$
- Diameter accuracy: $\pm 1\mu\text{m}$
- Made of ceramic, extremely wear resistance, corrosion resistance and dimensional stability

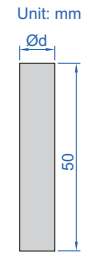

4113-10D00

Ordering examples:

Diameter	Code
1.21mm	4113-1D21
5.56mm	4113-5D56
15.00mm	4113-15D00

Note: "D" stands for "."

Diameter $\varnothing d$ (mm)
0.30, 0.31, 0.32, 0.33, ..., 1.00
1.01, 1.02, 1.03, 1.04, ..., 2.00
2.01, 2.02, 2.03, 2.04, ..., 3.00
3.01, 3.02, 3.03, 3.04, ..., 4.00
4.01, 4.02, 4.03, 4.04, ..., 5.00
5.01, 5.02, 5.03, 5.04, ..., 6.00
6.01, 6.02, 6.03, 6.04, ..., 7.00
7.01, 7.02, 7.03, 7.04, ..., 8.00
8.01, 8.02, 8.03, 8.04, ..., 9.00
9.01, 9.02, 9.03, 9.04, ..., 10.00

Diameter $\varnothing d$ (mm)
10.01, 10.02, 10.03, 10.04, ..., 11.00
11.01, 11.02, 11.03, 11.04, ..., 12.00
12.01, 12.02, 12.03, 12.04, ..., 13.00
13.01, 13.02, 13.03, 13.04, ..., 14.00
14.01, 14.02, 14.03, 14.04, ..., 15.00
15.01, 15.02, 15.03, 15.04, ..., 16.00
16.01, 16.02, 16.03, 16.04, ..., 17.00
17.01, 17.02, 17.03, 17.04, ..., 18.00
18.01, 18.02, 18.03, 18.04, ..., 19.00
19.01, 19.02, 19.03, 19.04, ..., 20.00

Code
4113-□□□□

CERAMIC INDIVIDUAL PIN GAUGES WITH THREE DECIMAL PLACES (0.001MM STEP)

- Meet DIN2269, grade 1
- Diameter range: $\varnothing 0.300\sim\varnothing 30.000\text{mm}$
- With three decimal, for example 1.211mm, 5.562mm, 14.955mm
- Diameter accuracy: $\pm 1\mu\text{m}$
- Made of ceramic, extremely wear resistance, corrosion resistance and dimensional stability

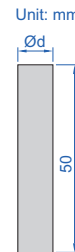

4192-10D000

Ordering examples:

Diameter	Code
1.211mm	4192-1D211
5.562mm	4192-5D562
14.955mm	4192-14D955

Note: "D" stands for "."

Code	Diameter range $\varnothing d$ (mm)
4192-□□□□	0.300-30.000

BOXES FOR PIN GAUGES

- For individual pin gauges (4110, 4118, 4192, 4113 and 4193 series)



7340

Code	Applicable pin gauge diameter $\varnothing d$	Quantity of pin gauges
7340	0.20-10.00mm	51 pcs
7340-101	0.20-10.00mm	101 pcs
7340-201	10.00-15.00mm	51 pcs
7340-202	15.00-20.00mm	51 pcs

PIN GAUGE HANDLE



7345-13

- Operated without wrench
- Made of aluminum

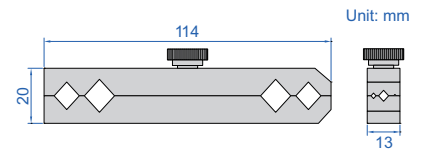

application



Code	Applicable pin gauge diameter
7345-13	1~13mm

PIN GAUGE HANDLES (OPERATED WITHOUT WRENCH)

12



7342-M1

- Operated without wrench
- Made of aluminum
- Pin gauges can be installed



(mm)

Code	Applicable pin gauge diameter	H	L
7342-M0	0.30-1.50mm/0.011-0.049"	10	112
7342-M1	1.51-6.35mm/0.050-0.250"	24	131
7342-M2	6.36-12.70mm/0.251-0.500"	32	152
7342-M3	12.71-15.88mm/0.501-0.625"	37	152
7342-M4	15.89-19.00mm/0.626-0.750"	37	152
7342-M5	19.01-21.13mm/0.751-0.832"	40	158
7342-M6	21.14-23.27mm/0.833-0.916"	40	158
7342-M7	23.28-25.40mm/0.917-1.000"	40	158

application



PIN GAUGE HANDLES (OPERATED WITH WRENCH)

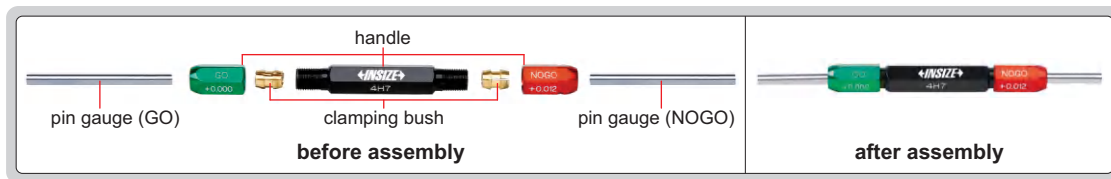

handle



brass clamping bush
(0.2~7.14mm)



aluminum clamping bush
(7.14~24.80mm)

- Wrench is needed to install pins
- Clamping bushes (0.2~7.14mm) are made of brass, clamping bushes (7.14~24.80mm) are made of aluminum

(mm)

Code	Applicable pin gauge diameter	Including		H	L
		handle	clamping bush (mm)		
7341-0S	0.2-1.02mm	1 pc	6 pairs (the clamping range are 0.2-0.38, 0.38-0.51, 0.51-0.64, 0.64-0.76, 0.76-0.89, 0.89-1.02)	7	57
7341-1S	1.02-1.91mm	1 pc	7 pairs (the clamping range are 1.02-1.14, 1.14-1.27, 1.27-1.40, 1.40-1.52, 1.52-1.65, 1.65-1.78, 1.78-1.91)	7	57
7341-2S	1.91-3.33mm	1 pc	8 pairs (the clamping range are 1.91-2.08, 2.08-2.26, 2.26-2.44, 2.44-2.62, 2.62-2.79, 2.79-2.97, 2.97-3.15, 3.15-3.33)	9	73
7341-3S	3.33-4.57mm	1 pc	7 pairs (the clamping range are 3.33-3.51, 3.51-3.68, 3.68-3.86, 3.86-4.04, 4.04-4.22, 4.22-4.39, 4.39-4.57)	9	73
7341-4S	4.57-5.79mm	1 pc	6 pairs (the clamping range are 4.57-4.78, 4.78-4.98, 4.98-5.18, 5.18-5.38, 5.38-5.59, 5.59-5.79)	14	79
7341-5S	5.79-7.14mm	1 pc	6 pairs (the clamping range are 5.79-5.99, 5.99-6.20, 6.20-6.40, 6.40-6.63, 6.63-6.88, 6.88-7.14)	14	79
7341-6S	7.14-8.66mm	1 pc	6 pairs (the clamping range are 7.14-7.39, 7.39-7.65, 7.65-7.90, 7.90-8.15, 8.15-8.41, 8.41-8.66)	19	91
7341-7S	8.66-10.31mm	1 pc	6 pairs (the clamping range are 8.66-8.92, 8.9-9.17, 9.17-9.42, 9.42-9.70, 9.70-10.01, 10.01-10.31)	19	91
7341-8S	10.31-11.81mm	1 pc	4 pairs (the clamping range are 10.31-10.67, 10.67-11.05, 11.05-11.43, 11.43-11.81)	22	106
7341-9S	11.81-12.95mm	1 pc	3 pairs (the clamping range are 11.81-12.19, 12.19-12.57, 12.57-12.95)	22	106
7341-10S	12.95-14.71mm	1 pc	4 pairs (the clamping range are 12.95-13.51, 13.51-13.89, 13.89-14.30, 14.30-14.71)	24	115
7341-11S	14.71-16.13mm	1 pc	4 pairs (the clamping range are 14.71-15.09, 15.09-15.49, 15.49-15.88, 15.88-16.13)	24	115
7341-12S	16.13-17.88mm	1 pc	4 pairs (the clamping range are 16.13-16.66, 16.66-17.07, 17.07-17.48, 17.48-17.88)	27	118
7341-13S	17.88-19.30mm	1 pc	4 pairs (the clamping range are 17.88-18.26, 18.26-18.67, 18.67-19.05, 19.05-19.30)	27	118
7341-15S	19.30-24.80mm	1 pc	8 pairs (the clamping range are 19.30-19.84, 19.84-20.62, 20.62-21.41, 21.41-22.23, 22.23-23.03, 23.03-23.80, 23.80-24.59, 24.59-24.80)	32	133

SINGLE END PIN GAUGE HANDLES (OPERATED WITH WRENCH)

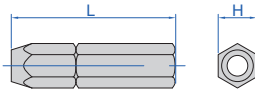
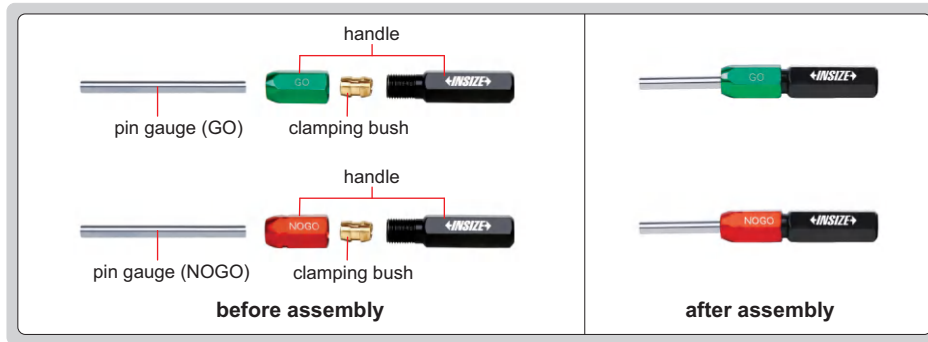

brass clamping bush
(0.2~7.14mm)



aluminum clamping bush
(7.14~24.80mm)

- Wrench is needed to install pins
- Clamping bushes (0.2~7.14mm) are made of brass, clamping bushes (7.14~24.80mm) are made of aluminum

(mm)

Code		Including		Applicable pin gauge diameter	H	L
green (GO)	red (NOGO)	handle	clamping bush (mm)			
7344-0G	7344-0R	1 pc	6 pcs (the clamping range are 0.2-0.38, 0.38-0.51, 0.51-0.64, 0.64-0.76, 0.76-0.89, 0.89-1.02)	0.2-1.02mm	7	52
7344-1G	7344-1R	1 pc	7 pcs (the clamping range are 1.02-1.14, 1.14-1.27, 1.27-1.40, 1.40-1.52, 1.52-1.65, 1.65-1.78, 1.78-1.91)	1.02-1.91mm	7	52
7344-2G	7344-2R	1 pc	8 pcs (the clamping range are 1.91-2.08, 2.08-2.26, 2.26-2.44, 2.44-2.62, 2.62-2.79, 2.79-2.97, 2.97-3.15, 3.15-3.33)	1.91-3.33mm	9	68
7344-3G	7344-3R	1 pc	7 pcs (the clamping range are 3.33-3.51, 3.51-3.68, 3.68-3.86, 3.86-4.04, 4.04-4.22, 4.22-4.39, 4.39-4.57)	3.33-4.57mm	9	68
7344-4G	7344-4R	1 pc	6 pcs (the clamping range are 4.57-4.78, 4.78-4.98, 4.98-5.18, 5.18-5.38, 5.38-5.59, 5.59-5.79)	4.57-5.79mm	14	73
7344-5G	7344-5R	1 pc	6 pcs (the clamping range are 5.79-5.99, 5.99-6.20, 6.20-6.40, 6.40-6.63, 6.63-6.88, 6.88-7.14)	5.79-7.14mm	14	73
7344-6G	7344-6R	1 pc	6 pcs (the clamping range are 7.14-7.39, 7.39-7.65, 7.65-7.90, 7.90-8.15, 8.15-8.41, 8.41-8.66)	7.14-8.66mm	19	79
7344-7G	7344-7R	1 pc	6 pcs (the clamping range are 8.66-8.92, 8.92-9.17, 9.17-9.42, 9.42-9.70, 9.70-10.01, 10.01-10.31)	8.66-10.31mm	19	79
7344-8G	7344-8R	1 pc	4 pcs (the clamping range are 10.31-10.67, 10.67-11.05, 11.05-11.43, 11.43-11.81)	10.31-11.81mm	22	93
7344-9G	7344-9R	1 pc	3 pcs (the clamping range are 11.81-12.19, 12.19-12.57, 12.57-12.95)	11.81-12.95mm	22	93
7344-10G	7344-10R	1 pc	4 pcs (the clamping range are 12.95-13.51, 13.51-13.89, 13.89-14.30, 14.30-14.71)	12.95-14.71mm	24	98
7344-11G	7344-11R	1 pc	4 pcs (the clamping range are 14.71-15.09, 15.09-15.49, 15.49-15.88, 15.88-16.13)	14.71-16.13mm	24	98
7344-12G	7344-12R	1 pc	4 pcs (the clamping range are 16.13-16.66, 16.66-17.07, 17.07-17.48, 17.48-17.88)	16.13-17.88mm	27	110
7344-13G	7344-13R	1 pc	4 pcs (the clamping range are 17.88-18.26, 18.26-18.67, 18.67-19.05, 19.05-19.30)	17.88-19.30mm	27	110
7344-15G	7344-15R	1 pc	8 pcs (the clamping range are 19.30-19.84, 19.84-20.62, 20.62-21.41, 21.41-22.23, 22.23-23.03, 23.03-23.80, 23.80-24.59, 24.59-24.80)	19.30-24.80mm	32	118

SETTING RINGS

- For zero setting of inside micrometers, three points internal micrometers and bore gauges
- The size marked on the setting ring is checked at the direction of the marking line
- Size difference (difference between the ordered size and the size marked on the setting ring when supplied): For example, the ordered size is Ø10.12mm, the size marked on the setting ring when supplied may be Ø10.130mm

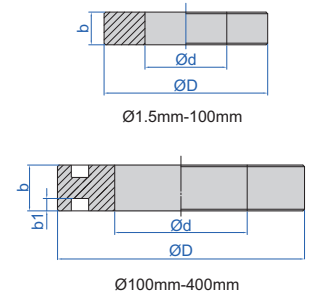

6312-20

Diameter d **	b	ØD	Size difference	Roundness and cylindricity
Ø1.5-2.5	4	22	±10.0µm	0.3µm
Ø2.5-3	5	22	±10.0µm	0.3µm
Ø3-5	5	22	±10.0µm	0.4µm
Ø5-10	8	32	±10.0µm	0.4µm
Ø10-15	10	38	±10.0µm	0.5µm
Ø15-18	12	45	±10.0µm	0.5µm
Ø18-20	12	45	±10.0µm	0.6µm
Ø20-25	14	53	±10.0µm	0.6µm
Ø25-30	16	63	±10.0µm	0.6µm
Ø30-32	16	63	±10.0µm	0.7µm
Ø32-40	18	71	±10.0µm	0.7µm
Ø40-50	20	85	±10.0µm	0.7µm
Ø50-60	20	100	±10.0µm	0.8µm
Ø60-70	24	112	±10.0µm	0.8µm
Ø70-80	24	125	±10.0µm	0.8µm
Ø80-90	24	140	±10.0µm	1.0µm
Ø90-100	24	160	±10.0µm	1.0µm

** For example Ø3-5mm means Ø3mm < diameter d ≤ Ø5mm

Diameter d **	b	b1	ØD	Size difference	Roundness and cylindricity
Ø100-110	30	8	164	±10.0µm	1.0µm
Ø110-130	34	10	192	±10.0µm	1.0µm
Ø130-150	34	10	220	±10.0µm	1.2µm
Ø150-170	36	10	248	±10.0µm	1.5µm
Ø170-190	36	10	276	±10.0µm	1.5µm
Ø190-210	38	10	300	±10.0µm	1.5µm
Ø210-230	38	10	324	±10.0µm	2.5µm
Ø230-250	40	12	350	±10.0µm	2.5µm
Ø250-270	40	12	375	±10.0µm	3.0µm
Ø270-290	42	12	400	±10.0µm	3.0µm
Ø290-300	42	12	425	±10.0µm	3.0µm
Ø300-320	42	12	430	±10.0µm	4.0µm
Ø320-330	42	12	440	±10.0µm	4.0µm
Ø330-340	42	12	450	±10.0µm	4.0µm
Ø340-350	42	12	460	±10.0µm	4.0µm
Ø350-360	42	12	470	±10.0µm	4.0µm
Ø360-370	42	12	480	±10.0µm	4.0µm
Ø370-380	42	12	490	±10.0µm	4.0µm
Ø380-390	42	12	500	±10.0µm	4.0µm
Ø390-400	42	12	510	±10.0µm	4.0µm

Code	Size (mm)
6312-1D5 *	Ø1.5
6312-2 *	Ø2
6312-2D5 *	Ø2.5
6312-3 *	Ø3
6312-3D5 *	Ø3.5
6312-4 *	Ø4
6312-4D5 *	Ø4.5
6312-5 *	Ø5
6312-5D5 *	Ø5.5
6312-6 *	Ø6
6312-6D5 *	Ø6.5
6312-7 *	Ø7
6312-7D5 *	Ø7.5
6312-8 *	Ø8
6312-8D5 *	Ø8.5
6312-9 *	Ø9
6312-9D5 *	Ø9.5
6312-10 *	Ø10
6312-10D5 *	Ø10.5
6312-11 *	Ø11
6312-11D5 *	Ø11.5
6312-12 *	Ø12

Code	Size (mm)
6312-12D5 *	Ø12.5
6312-13 *	Ø13
6312-13D5 *	Ø13.5
6312-14 *	Ø14
6312-14D5 *	Ø14.5
6312-15 *	Ø15
6312-15D5 *	Ø15.5
6312-16 *	Ø16
6312-16D5 *	Ø16.5
6312-17 *	Ø17
6312-17D5 *	Ø17.5
6312-18 *	Ø18
6312-18D5 *	Ø18.5
6312-19 *	Ø19
6312-19D5 *	Ø19.5
6312-20 *	Ø20
6312-20D5 *	Ø20.5
6312-21 *	Ø21
6312-21D5 *	Ø21.5
6312-22 *	Ø22
6312-22D5 *	Ø22.5
6312-23 *	Ø23

Code	Size (mm)
6312-23D5 *	Ø23.5
6312-24 *	Ø24
6312-24D5 *	Ø24.5
6312-25 *	Ø25
6312-25D5 *	Ø25.5
6312-26 *	Ø26
6312-26D5 *	Ø26.5
6312-27 *	Ø27
6312-27D5 *	Ø27.5
6312-28 *	Ø28
6312-28D5 *	Ø28.5
6312-29 *	Ø29
6312-29D5 *	Ø29.5
6312-30 *	Ø30
6312-31 *	Ø31
6312-32 *	Ø32
6312-33 *	Ø33
6312-34 *	Ø34
6312-35 *	Ø35
6312-36 *	Ø36
6312-37 *	Ø37
6312-38 *	Ø38

Code	Size (mm)
6312-39 *	Ø39
6312-40 *	Ø40
6312-41 *	Ø41
6312-42 *	Ø42
6312-43 *	Ø43
6312-44 *	Ø44
6312-45 *	Ø45
6312-46 *	Ø46
6312-47 *	Ø47
6312-48 *	Ø48
6312-49 *	Ø49
6312-50 *	Ø50
6312-55 *	Ø55
6312-60 *	Ø60
6312-62 *	Ø62
6312-65 *	Ø65
6312-70 *	Ø70
6312-75 *	Ø75
6312-80 *	Ø80
6312-85 *	Ø85
6312-87 *	Ø87
6312-90 *	Ø90

Code	Size (mm)
6312-95 *	Ø95
6312-100 *	Ø100
6312-112D5 *	Ø112.5
6312-125 *	Ø125
6312-137D5 *	Ø137.5
6312-150 *	Ø150
6312-162D5 *	Ø162.5
6312-175 *	Ø175
6312-187D5 *	Ø187.5
6312-200 *	Ø200
6312-212D5 *	Ø212.5
6312-225 *	Ø225
6312-237D5 *	Ø237.5
6312-250 *	Ø250
6312-262D5 *	Ø262.5
6312-275 *	Ø275
6312-287D5 *	Ø287.5
6312-300 *	Ø300
6312-350 *	Ø350
6312-400 *	Ø400

* Supplied with manufacturer inspection certificate

CARBIDE SETTING RINGS

CAN SUPPLY CUSTOM SETTING RINGS FROM Ø0.40MM TO Ø50.00MM, FOR EXAMPLE, Ø17.08MM

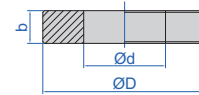

6317-10

- For zero setting of inside micrometers, three points internal micrometers and bore gauges
- Size difference (difference between the ordered size and the size marked on the setting ring when supplied): For example, the ordered size is Ø10.00mm, the size marked on the setting ring when supplied may be Ø10.002mm
- Meet DIN2250-1:2008

(mm)

Diameter d**	b	ØD	Size difference	Roundness and cylindricity
Ø0.4-0.5	4	10	±10µm	0.3µm
Ø0.5-1.6	6	10	±10µm	0.3µm
Ø1.6-12.1	8	30	±10µm	0.3µm
Ø12.1-18.1	12	40	±10µm	0.4µm
Ø18.1-25	15	50	±10µm	0.4µm
Ø25-30	15	60	±10µm	0.4µm
Ø30-35	18	80	±10µm	0.4µm
Ø35-40	20	80	±10µm	0.4µm
Ø40-45	20	90	±10µm	0.4µm
Ø45-50	20	100	±10µm	0.4µm

** For example Ø0.4-0.5mm means Ø0.4mm < diameter d ≤ Ø0.5mm

Code	Size
6317-0D5 *	Ø0.5mm
6317-1 *	Ø1mm
6317-1D5 *	Ø1.5mm
6317-2 *	Ø2mm
6317-2D5 *	Ø2.5mm
6317-3 *	Ø3mm
6317-3D5 *	Ø3.5mm
6317-4 *	Ø4mm
6317-4D5 *	Ø4.5mm
6317-5 *	Ø5mm
6317-5D5 *	Ø5.5mm
6317-6 *	Ø6mm
6317-6D5 *	Ø6.5mm
6317-7 *	Ø7mm
6317-7D5 *	Ø7.5mm
6317-8 *	Ø8mm
6317-8D5 *	Ø8.5mm
6317-9 *	Ø9mm
6317-9D5 *	Ø9.5mm
6317-10 *	Ø10mm

Code	Size
6317-10D5 *	Ø10.5mm
6317-11 *	Ø11mm
6317-11D5 *	Ø11.5mm
6317-12 *	Ø12mm
6317-12D5 *	Ø12.5mm
6317-13 *	Ø13mm
6317-13D5 *	Ø13.5mm
6317-14 *	Ø14mm
6317-14D5 *	Ø14.5mm
6317-15 *	Ø15mm
6317-15D5 *	Ø15.5mm
6317-16 *	Ø16mm
6317-16D5 *	Ø16.5mm
6317-17 *	Ø17mm
6317-17D5 *	Ø17.5mm
6317-18 *	Ø18mm
6317-18D5 *	Ø18.5mm
6317-19 *	Ø19mm
6317-19D5 *	Ø19.5mm
6317-20 *	Ø20mm

Code	Size
6317-20D5 *	Ø20.5mm
6317-21 *	Ø21mm
6317-21D5 *	Ø21.5mm
6317-22 *	Ø22mm
6317-22D5 *	Ø22.5mm
6317-23 *	Ø23mm
6317-23D5 *	Ø23.5mm
6317-24 *	Ø24mm
6317-24D5 *	Ø24.5mm
6317-25 *	Ø25mm
6317-25D5 *	Ø25.5mm
6317-26 *	Ø26mm
6317-26D5 *	Ø26.5mm
6317-27 *	Ø27mm
6317-27D5 *	Ø27.5mm
6317-28 *	Ø28mm
6317-28D5 *	Ø28.5mm
6317-29 *	Ø29mm
6317-29D5 *	Ø29.5mm
6317-30 *	Ø30mm

Code	Size
6317-31 *	Ø31mm
6317-32 *	Ø32mm
6317-33 *	Ø33mm
6317-34 *	Ø34mm
6317-35 *	Ø35mm
6317-36 *	Ø36mm
6317-37 *	Ø37mm
6317-38 *	Ø38mm
6317-39 *	Ø39mm
6317-40 *	Ø40mm
6317-41 *	Ø41mm
6317-42 *	Ø42mm
6317-43 *	Ø43mm
6317-44 *	Ø44mm
6317-45 *	Ø45mm
6317-46 *	Ø46mm
6317-47 *	Ø47mm
6317-48 *	Ø48mm
6317-49 *	Ø49mm
6317-50 *	Ø50mm

* Supplied with manufacturer inspection certificate

CAN SUPPLY CUSTOM SETTING RINGS FROM Ø1.30MM TO Ø50.00MM, FOR EXAMPLE, Ø17.08MM

CERAMIC SETTING RINGS



6319-10

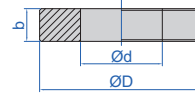

- For zero setting of inside micrometers, three points internal micrometers and bore gauges
- Size difference (difference between the ordered size and the size marked on the setting ring when supplied):
For example, the ordered size is Ø10.12mm, the size marked on the setting ring when supplied may be Ø10.130mm
- Made of ceramic, extremely wear resistance and corrosion resistance, dimensional stability
- Meet DIN2250-1:2008

(mm)				
Diameter d **	b	ØD	Size difference	Roundness and cylindricity
Ø1.3-2.7	6	20	±10µm	0.3µm
Ø2.7-12.1	8	30	±10µm	0.3µm
Ø12.1-18.1	12	40	±10µm	0.4µm
Ø18.1-25	15	50	±10µm	0.4µm
Ø25-30	15	60	±10µm	0.4µm
Ø30-35	18	80	±10µm	0.4µm
Ø35-40	20	80	±10µm	0.4µm
Ø40-45	20	90	±10µm	0.4µm
Ø45-50	20	100	±10µm	0.4µm

** For example Ø1.3-2.7mm means Ø1.3mm < diameter d ≤ Ø2.7mm

Code	Size
6319-1D5 *	Ø1.5mm
6319-2 *	Ø2mm
6319-2D5 *	Ø2.5mm
6319-3 *	Ø3mm
6319-3D5 *	Ø3.5mm
6319-4 *	Ø4mm
6319-4D5 *	Ø4.5mm
6319-5 *	Ø5mm
6319-5D5 *	Ø5.5mm
6319-6 *	Ø6mm
6319-6D5 *	Ø6.5mm
6319-7 *	Ø7mm
6319-7D5 *	Ø7.5mm
6319-8 *	Ø8mm
6319-8D5 *	Ø8.5mm
6319-9 *	Ø9mm
6319-9D5 *	Ø9.5mm
6319-10 *	Ø10mm
6319-10D5 *	Ø10.5mm

Code	Size
6319-11 *	Ø11mm
6319-11D5 *	Ø11.5mm
6319-12 *	Ø12mm
6319-12D5 *	Ø12.5mm
6319-13 *	Ø13mm
6319-13D5 *	Ø13.5mm
6319-14 *	Ø14mm
6319-14D5 *	Ø14.5mm
6319-15 *	Ø15mm
6319-15D5 *	Ø15.5mm
6319-16 *	Ø16mm
6319-16D5 *	Ø16.5mm
6319-17 *	Ø17mm
6319-17D5 *	Ø17.5mm
6319-18 *	Ø18mm
6319-18D5 *	Ø18.5mm
6319-19 *	Ø19mm
6319-19D5 *	Ø19.5mm
6319-20 *	Ø20mm

Code	Size
6319-20D5 *	Ø20.5mm
6319-21 *	Ø21mm
6319-21D5 *	Ø21.5mm
6319-22 *	Ø22mm
6319-22D5 *	Ø22.5mm
6319-23 *	Ø23mm
6319-23D5 *	Ø23.5mm
6319-24 *	Ø24mm
6319-24D5 *	Ø24.5mm
6319-25 *	Ø25mm
6319-25D5 *	Ø25.5mm
6319-26 *	Ø26mm
6319-26D5 *	Ø26.5mm
6319-27 *	Ø27mm
6319-27D5 *	Ø27.5mm
6319-28 *	Ø28mm
6319-28D5 *	Ø28.5mm
6319-29 *	Ø29mm
6319-29D5 *	Ø29.5mm
6319-30 *	Ø30mm

Code	Size
6319-31 *	Ø31mm
6319-32 *	Ø32mm
6319-33 *	Ø33mm
6319-34 *	Ø34mm
6319-35 *	Ø35mm
6319-36 *	Ø36mm
6319-37 *	Ø37mm
6319-38 *	Ø38mm
6319-39 *	Ø39mm
6319-40 *	Ø40mm
6319-41 *	Ø41mm
6319-42 *	Ø42mm
6319-43 *	Ø43mm
6319-44 *	Ø44mm
6319-45 *	Ø45mm
6319-46 *	Ø46mm
6319-47 *	Ø47mm
6319-48 *	Ø48mm
6319-49 *	Ø49mm
6319-50 *	Ø50mm

* Supplied with manufacturer inspection certificate

CYLINDER GAUGES

CAN SUPPLY CUSTOM SIZES FROM Ø3.000mm TO Ø200.000mm, FOR EXAMPLE, Ø20.218mm



- Made of tungsten steel, quenched, ultra-low temperature treatment
- Wear resistant, long life, dimension stability
- Hardness HRC60-62



6316-30

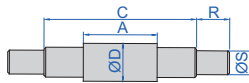

(mm)

Diameter ØD **	A	C	R	ØS	Size *** difference	Roundness and cylindricity
3.0-3.81	9.52	17.46	11.1	2.4	±5µm	0.5µm
3.81-5.84	11.11	19.05	11.1	3.2	±5µm	0.5µm
5.84-9.27	12.7	20.64	11.1	5.6	±5µm	0.5µm

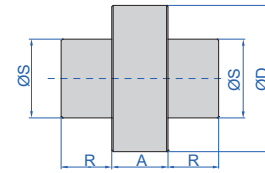

(mm)

Diameter ØD **	A	ØS	R	Size *** difference	Roundness and cylindricity
38.35-51.05	31.8	22.2	15.8	±5µm	1µm
51.05-63.75	31.8	22.2	15.8	±5µm	1µm
63.75-76.45	38.1	25.4	39.8	±5µm	1.2µm
76.45-89.15	38.1	25.4	39.8	±5µm	1.2µm
89.15-101.85	38.1	25.4	39.8	±5µm	1.2µm
101.85-114.55	38.1	25.4	39.8	±5µm	1.2µm
114.55-127.25	38.1	25.4	39.8	±5µm	1.6µm
127.25-139.95	38.1	25.4	39.8	±5µm	1.6µm
139.95-152.62	38.1	25.4	39.8	±5µm	1.6µm
152.65-165.35	38.1	25.4	39.8	±5µm	1.6µm
165.35-178.05	38.1	25.4	39.8	±5µm	2µm
178.05-190.75	38.1	25.4	39.8	±5µm	2µm
190.75-203.45	38.1	25.4	39.8	±5µm	2µm

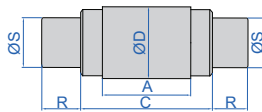

(mm)

Diameter ØD **	A	C	R	ØS	Size *** difference	Roundness and cylindricity
9.27-12.95	14.29	22.22	12.7	8.7	±5µm	0.5µm
12.95-20.96	15.88	23.81	12.7	12.7	±5µm	0.5µm
20.96-28.83	17.46	25.4	15.9	19	±5µm	0.7µm
28.83-38.35	20.64	28.58	15.9	25.4	±5µm	0.7µm

** For example, 3-3.81 indicates 3mm<D≤3.8mm

*** Size difference (difference between the ordered size and the size marked on the cylinder gauges when supplied).

For example, the ordered size is Ø3.000mm, the size marked on the cylinder gauges when supplied may be Ø3.003mm

Code	ØD
6316-3 *	Ø3mm
6316-4 *	Ø4mm
6316-5 *	Ø5mm
6316-6 *	Ø6mm
6316-7 *	Ø7mm
6316-8 *	Ø8mm
6316-9 *	Ø9mm
6316-10 *	Ø10mm
6316-11 *	Ø11mm
6316-12 *	Ø12mm
6316-13 *	Ø13mm
6316-14 *	Ø14mm
6316-15 *	Ø15mm

Code	ØD
6316-16 *	Ø16mm
6316-17 *	Ø17mm
6316-18 *	Ø18mm
6316-19 *	Ø19mm
6316-20 *	Ø20mm
6316-21 *	Ø21mm
6316-22 *	Ø22mm
6316-23 *	Ø23mm
6316-24 *	Ø24mm
6316-25 *	Ø25mm
6316-26 *	Ø26mm
6316-27 *	Ø27mm
6316-28 *	Ø28mm

Code	ØD
6316-29 *	Ø29mm
6316-30 *	Ø30mm
6316-31 *	Ø31mm
6316-32 *	Ø32mm
6316-33 *	Ø33mm
6316-34 *	Ø34mm
6316-35 *	Ø35mm
6316-36 *	Ø36mm
6316-37 *	Ø37mm
6316-38 *	Ø38mm
6316-39 *	Ø39mm
6316-40 *	Ø40mm
6316-41 *	Ø41mm

Code	ØD
6316-42 *	Ø42mm
6316-43 *	Ø43mm
6316-44 *	Ø44mm
6316-45 *	Ø45mm
6316-46 *	Ø46mm
6316-47 *	Ø47mm
6316-48 *	Ø48mm
6316-49 *	Ø49mm
6316-50 *	Ø50mm
6316-55 *	Ø55mm
6316-60 *	Ø60mm
6316-62 *	Ø62mm
6316-65 *	Ø65mm

Code	ØD
6316-70 *	Ø70mm
6316-75 *	Ø75mm
6316-80 *	Ø80mm
6316-85 *	Ø85mm
6316-87 *	Ø87mm
6316-90 *	Ø90mm
6316-95 *	Ø95mm
6316-100 *	Ø100mm
6316-125 *	Ø125mm
6316-150 *	Ø150mm
6316-175 *	Ø175mm
6316-200 *	Ø200mm

*Supplied with manufacturer inspection certificate

FAST AND ACCURATE
MEASUREMENT OF CYLINDERS



ADJUSTABLE SNAP GAUGES

- Used as Go/No-Go gauge by setting upper and lower limits
- Flatness of anvil: 1.5µm
- Parallelism of measuring faces:
range 0-32mm: 3µm
range 32-89mm: 4µm
range 89-300mm: 5µm

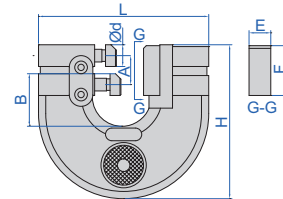

2187-19

(mm)

Code	Range	L	A	B	E	F	H	Ød
2187-6	0-6mm	74	15	17.5	12.2	27.2	71.5	7
2187-13	6-13mm	85	15	26	12.2	27.2	79.5	12.3
2187-19	13-19mm	93	15	27	12.2	27.2	83	12.3
2187-25	19-25mm	100	15	33.5	12.2	27.2	89.5	12.3
2187-32	25-32mm	111	18	38.5	15.2	35.2	104	15.3
2187-38	32-38mm	117	18	41.5	15.2	35.2	105	15.3
2187-44	38-44mm	123	18	44.5	15.2	35.2	109	15.3
2187-51	44-51mm	130	18	48	15.2	35.2	117	15.3
2187-57	51-57mm	136	18	45	15.2	35.2	119	15.3
2187-63	57-63mm	143	18	50	15.2	35.2	122	15.3
2187-70	63-70mm	156	20	58	15.2	35.2	132	15.3
2187-76	70-76mm	163	20	60.5	15.2	35.2	137	15.3
2187-82	76-82mm	169	20	64.5	15.2	35.2	140	15.3
2187-89	82-89mm	175	20	66.5	15.2	35.2	146	15.3
2187-95	89-95mm	181	20	69.5	15.2	35.2	149	15.3
2187-101	95-101mm	188	20	70	15.2	35.2	154	15.3
2187-108	101-108mm	198	24	79	15.2	39.2	166	15.3
2187-114	108-114mm	204	24	81	15.2	39.2	172	15.3
2187-120	114-120mm	210	24	86	15.2	39.2	179	15.3
2187-127	120-127mm	217	24	89.5	15.2	39.2	186	15.3
2187-133	127-133mm	223	24	92.5	15.2	39.2	192	15.3
2187-139	133-139mm	229	24	95.5	15.2	39.2	197	15.3
2187-146	139-146mm	235	24	98.5	15.2	39.2	201	15.3
2187-152	146-152mm	242	24	102	15.2	39.2	205	15.3
2187-163	152-163mm	273	21.4	106.7	18.2	39.2	211	18.3
2187-175	163-175mm	273	21.4	106.7	18.2	39.2	211	18.3
2187-188	175-188mm	298.5	21.4	119.7	18.2	39.2	227	18.3
2187-200	188-200mm	298.5	21.4	119.7	18.2	39.2	227	18.3
2187-213	200-213mm	324	21.4	131.7	18.2	39.2	242	18.3
2187-225	213-225mm	324	21.4	131.7	18.2	39.2	242	18.3
2187-238	225-238mm	349.5	21.4	144.7	18.2	39.2	250	18.3
2187-250	238-250mm	349.5	21.4	149	18.2	39.2	250	18.3
2187-263	250-263mm	375.5	21.4	157.7	18.2	39.2	278	18.3
2187-275	263-275mm	375.5	21.4	157.7	18.2	39.2	278	18.3
2187-288	275-288mm	400	21.4	170.7	18.2	39.2	291	18.3
2187-300	288-300mm	400	21.4	170.7	18.2	39.2	291	18.3

PLAIN PLUG GAUGES

CUSTOM-MADE
 OTHER CLASSES ARE AVAILABLE, SUCH AS H8, H9
 OTHER DIAMETERS ARE AVAILABLE, SUCH AS 19.003mm
 OTHER LENGTHS ARE AVAILABLE, SUCH AS 70mm

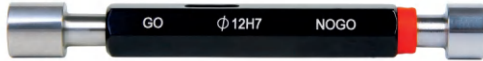

4124-12

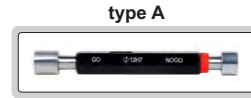

type A

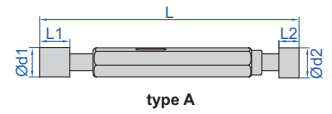

type A

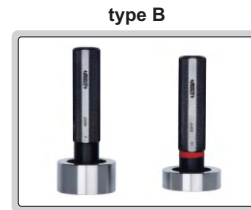

type B

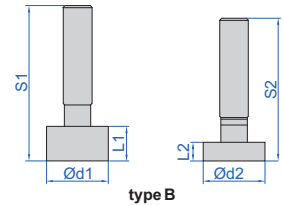

type B

- Supplied with Go and No-Go gauges together
- Class H7
- Hardness HRC 60±2
- Standard DIN7150-2

Size tolerance of H7

(mm)

Diameter Ød	Type	Size tolerance of Go gauge (µm)	Size tolerance of No-Go gauge (µm)	L1	L2	L	S1, S2
≥2, ≤3	A	+0.5/+2.5	+9/+11	6.5	4.5	62	–
>3, ≤6	A	+0.75/+3.25	+10.75/+13.25	8	6	74	–
>6, ≤10	A	+0.75/+3.25	+13.75/+16.25	10	7	87	–
>10, ≤14	A	+1/+4	+16.5/+19.5	12	8	99	–
>14, ≤18	A	+1/+4	+16.5/+19.5	14	10	114	–
>18, ≤24	A	+1/+5	+19/+23	16	12	132	–
>24, ≤30	A	+1/+5	+19/+23	18	14	136	–
>30, ≤40	A	+1.5/+5.5	+23/+27	20	15	155	–
>40, ≤50	A	+1.5/+5.5	+23/+27	25	18	169	–
>50, ≤65	B	+1.5/+6.5	+27.5/+32.5	30	18	–	164, 152
>65, ≤80	B	+1.5/+6.5	+27.5/+32.5	35	25	–	169, 159
>80, ≤100	B	+2/+8	+32/+38	35	25	–	169, 159

Code	Diameter	Type	Code	Diameter	Type	Code	Diameter	Type	Code	Diameter	Type
4124-2	2mm	A	4124-17	17mm	A	4124-32	32mm	A	4124-47	47mm	A
4124-3	3mm	A	4124-18	18mm	A	4124-33	33mm	A	4124-48	48mm	A
4124-4	4mm	A	4124-19	19mm	A	4124-34	34mm	A	4124-49	49mm	A
4124-5	5mm	A	4124-20	20mm	A	4124-35	35mm	A	4124-50	50mm	A
4124-6	6mm	A	4124-21	21mm	A	4124-36	36mm	A	4124-52	52mm	B
4124-7	7mm	A	4124-22	22mm	A	4124-37	37mm	A	4124-55	55mm	B
4124-8	8mm	A	4124-23	23mm	A	4124-38	38mm	A	4124-60	60mm	B
4124-9	9mm	A	4124-24	24mm	A	4124-39	39mm	A	4124-65	65mm	B
4124-10	10mm	A	4124-25	25mm	A	4124-40	40mm	A	4124-70	70mm	B
4124-11	11mm	A	4124-26	26mm	A	4124-41	41mm	A	4124-75	75mm	B
4124-12	12mm	A	4124-27	27mm	A	4124-42	42mm	A	4124-80	80mm	B
4124-13	13mm	A	4124-28	28mm	A	4124-43	43mm	A	4124-85	85mm	B
4124-14	14mm	A	4124-29	29mm	A	4124-44	44mm	A	4124-90	90mm	B
4124-15	15mm	A	4124-30	30mm	A	4124-45	45mm	A	4124-95	95mm	B
4124-16	16mm	A	4124-31	31mm	A	4124-46	46mm	A	4124-100	100mm	B

CUSTOM-MADE
OTHER CLASSES ARE AVAILABLE, SUCH AS H8, H9, G7
OTHER DIAMETERS ARE AVAILABLE, SUCH AS 19.003mm
OTHER LENGTHS ARE AVAILABLE, SUCH AS 70mm



CARBIDE PLAIN PLUG GAUGES

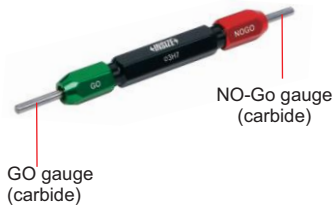

4128-3



4128-50

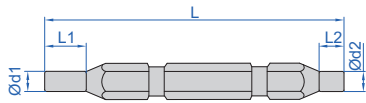

type A

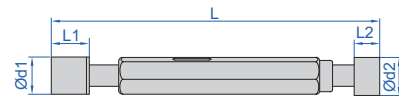

type B

- Supplied with Go and No-Go gauges together
- Standard DIN7150-2

Size tolerance of H7

(mm)

Diameter	Size tolerance of Go gauge Ød1 (µm)	Size tolerance of No-Go gauge Ød2 (µm)	L1	L2	L
≥1, ≤1.9	+0.5/+2.5	+9/+11	15	12	67
>1.9, ≤3	+0.5/+2.5	+9/+11	15	12	79
>3, ≤4.7	+0.75/+3.25	+10.75/+13.25	15	12	79
>4.7, ≤6	+0.75/+3.25	+10.75/+13.25	15	12	88.5
>6, ≤7.1	+0.75/+3.25	+13.75/+16.25	15	12	88.5
>7.1, ≤8	+0.75/+3.25	+13.75/+16.25	15	12	99
>8, ≤10	+0.75/+3.25	+13.75/+16.25	12	7	75
>10, ≤14	+1/+4	+16.5/+19.5	12	7	82
>14, ≤18	+1/+4	+16.5/+19.5	17	10	97
>18, ≤24	+1/+5	+19/+23	17	12	109
>24, ≤30	+1/+5	+19/+23	17	14	111
>30, ≤40	+1.5/+5.5	+23/+27	20	15	115
>40, ≤50	+1.5/+5.5	+23/+27	20	15	160
>50, ≤60	+1.5/+6.5	+27.5/+32.5	20	15	160

H7

(mm)

Code	Diameter	Type	Code	Diameter	Type	Code	Diameter	Type	Code	Diameter	Type
4128-1*	1	A	4128-14*	14	B	4128-27*	27	B	4128-40*	40	B
4128-2*	2	A	4128-15*	15	B	4128-28*	28	B	4128-41*	41	B
4128-3*	3	A	4128-16*	16	B	4128-29*	29	B	4128-42*	42	B
4128-4*	4	A	4128-17*	17	B	4128-30*	30	B	4128-43*	43	B
4128-5*	5	A	4128-18*	18	B	4128-31*	31	B	4128-44*	44	B
4128-6*	6	A	4128-19*	19	B	4128-32*	32	B	4128-45*	45	B
4128-7*	7	A	4128-20*	20	B	4128-33*	33	B	4128-46*	46	B
4128-8*	8	A	4128-21*	21	B	4128-34*	34	B	4128-47*	47	B
4128-9*	9	B	4128-22*	22	B	4128-35*	35	B	4128-48*	48	B
4128-10*	10	B	4128-23*	23	B	4128-36*	36	B	4128-49*	49	B
4128-11*	11	B	4128-24*	24	B	4128-37*	37	B	4128-50*	50	B
4128-12*	12	B	4128-25*	25	B	4128-38*	38	B	4128-52*	52	B
4128-13*	13	B	4128-26*	26	B	4128-39*	39	B	4128-55*	55	B
									4128-60*	60	B

* Supplied with manufacturer inspection certificate

CARBIDE PLAIN PLUG GAUGES (SINGLE END)

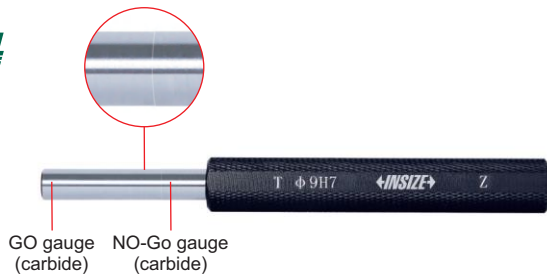

6331-9

- Supplied with Go and No-Go gauges together
- Standard DIN7150-2

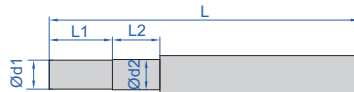

Size tolerance of H7

Diameter	Size tolerance of Go gauge Ød1 (µm)	Size tolerance of No-Go gauge Ød2 (µm)	L1	L2	L
≥0.5, ≤3	+0.5/+2.5	+9/+11	20	15	95
>3, ≤6	+0.75/+3.25	+10.75/+13.25	20	15	95
>6, ≤10	+0.75/+3.25	+13.75/+16.25	20	15	95
>10, ≤15	+1/+4	+16.5/+19.5	20	15	95
>15, ≤18	+1/+4	+16.5/+19.5	20	15	115
>18, ≤30	+1/+5	+19/+23	20	15	115
>30, ≤40	+1.5/+5.5	+23/+27	20	15	115

CUSTOM-MADE
OTHER CLASSES ARE AVAILABLE, SUCH AS H8, H9, G7
OTHER DIAMETERS ARE AVAILABLE, SUCH AS 19.003mm
OTHER LENGTHS ARE AVAILABLE, SUCH AS 70mm

H7

Code	Diameter	Code	Diameter
6331-1 *	1	6331-21 *	21
6331-2 *	2	6331-22 *	22
6331-3 *	3	6331-23 *	23
6331-4 *	4	6331-24 *	24
6331-5 *	5	6331-25 *	25
6331-6 *	6	6331-26 *	26
6331-7 *	7	6331-27 *	27
6331-8 *	8	6331-28 *	28
6331-9 *	9	6331-29 *	29
6331-10 *	10	6331-30 *	30
6331-11 *	11	6331-31 *	31
6331-12 *	12	6331-32 *	32
6331-13 *	13	6331-33 *	33
6331-14 *	14	6331-34 *	34
6331-15 *	15	6331-35 *	35
6331-16 *	16	6331-36 *	36
6331-17 *	17	6331-37 *	37
6331-18 *	18	6331-38 *	38
6331-19 *	19	6331-39 *	39
6331-20 *	20	6331-40 *	40

* Supplied with manufacturer inspection certificate

CERAMIC PLAIN PLUG GAUGES (SINGLE END)



6333-10

- Supplied with Go and No-Go gauges together
- Made of ceramic, extremely wear resistance and corrosion resistance, dimensional stability
- Standard DIN7150-2

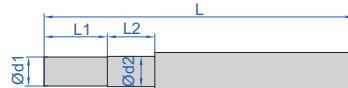

Size tolerance of H7

Diameter	Size tolerance of Go gauge Ød1 (µm)	Size tolerance of No-Go gauge Ød2 (µm)	L1	L2	L
≥0.5, ≤3	+0.5/+2.5	+9/+11	20	15	95
>3, ≤6	+0.75/+3.25	+10.75/+13.25	20	15	95
>6, ≤10	+0.75/+3.25	+13.75/+16.25	20	15	95
>10, ≤15	+1/+4	+16.5/+19.5	20	15	95
>15, ≤18	+1/+4	+16.5/+19.5	20	15	115
>18, ≤30	+1/+5	+19/+23	20	15	115
>30, ≤40	+1.5/+5.5	+23/+27	20	15	115

CUSTOM-MADE
OTHER CLASSES ARE AVAILABLE, SUCH AS H8, H9, G7
OTHER DIAMETERS ARE AVAILABLE, SUCH AS 19.003mm
OTHER LENGTHS ARE AVAILABLE, SUCH AS 70mm

H7

Code	Diameter	Code	Diameter
6333-1 *	1	6333-21 *	21
6333-2 *	2	6333-22 *	22
6333-3 *	3	6333-23 *	23
6333-4 *	4	6333-24 *	24
6333-5 *	5	6333-25 *	25
6333-6 *	6	6333-26 *	26
6333-7 *	7	6333-27 *	27
6333-8 *	8	6333-28 *	28
6333-9 *	9	6333-29 *	29
6333-10 *	10	6333-30 *	30
6333-11 *	11	6333-31 *	31
6333-12 *	12	6333-32 *	32
6333-13 *	13	6333-33 *	33
6333-14 *	14	6333-34 *	34
6333-15 *	15	6333-35 *	35
6333-16 *	16	6333-36 *	36
6333-17 *	17	6333-37 *	37
6333-18 *	18	6333-38 *	38
6333-19 *	19	6333-39 *	39
6333-20 *	20	6333-40 *	40

* Supplied with manufacturer inspection certificate

CERAMIC PLAIN PLUG GAUGES

CUSTOM-MADE

OTHER CLASSES ARE AVAILABLE, SUCH AS H8, H9, G7
OTHER DIAMETERS ARE AVAILABLE, SUCH AS 19.003mm
OTHER LENGTHS ARE AVAILABLE, SUCH AS 70mm

- Supplied with Go and No-Go gauges together
- Made of ceramic, extremely wear resistance and corrosion resistance, dimensional stability
- Standard DIN7150-2



Size tolerance of H7

(mm)

Diameter	Size tolerance of Go gauge Ød1 (µm)	Size tolerance of No-Go gauge Ød2 (µm)	L1	L2	L
≥0.5, ≤3	+0.5/+2.5	+9/+11	20	15	95
>3, ≤6	+0.75/+3.25	+10.75/+13.25	20	15	95
>6, ≤10	+0.75/+3.25	+13.75/+16.25	20	15	95
>10, ≤15	+1/+4	+16.5/+19.5	20	15	95
>15, ≤18	+1/+4	+16.5/+19.5	20	15	115
>18, ≤30	+1/+5	+19/+23	20	15	115
>30, ≤40	+1.5/+5.5	+23/+27	20	15	115

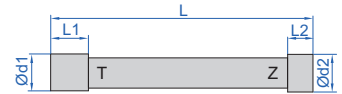

H7

(mm)

Code	Diameter	Code	Diameter	Code	Diameter	Code	Diameter	Code	Diameter
6332-1*	1	6332-11*	11	6332-21*	21	6332-31*	31	6332-41*	41
6332-2*	2	6332-12*	12	6332-22*	22	6332-32*	32	6332-42*	42
6332-3*	3	6332-13*	13	6332-23*	23	6332-33*	33	6332-43*	43
6332-4*	4	6332-14*	14	6332-24*	24	6332-34*	34	6332-44*	44
6332-5*	5	6332-15*	15	6332-25*	25	6332-35*	35	6332-45*	45
6332-6*	6	6332-16*	16	6332-26*	26	6332-36*	36	6332-46*	46
6332-7*	7	6332-17*	17	6332-27*	27	6332-37*	37	6332-47*	47
6332-8*	8	6332-18*	18	6332-28*	28	6332-38*	38	6332-48*	48
6332-9*	9	6332-19*	19	6332-29*	29	6332-39*	39	6332-49*	49
6332-10*	10	6332-20*	20	6332-30*	30	6332-40*	40	6332-50*	50

* Supplied with manufacturer inspection certificate

CUSTOM-MADE

SPLINE PLUG GAUGES CODE 6341

- Suitable for pass or fail inspection of internal splines
- Made of high carbon alloy tool steel
- Hardness HRC60-62
- Information required for order: number of teeth, module, pressure angle and lrance grade of splines



SPLINE RING GAUGES CODE 6342

CUSTOM-MADE



- Suitable for pass or fail inspection of external splines
- Made of high carbon alloy tool steel
- Hardness HRC60-62
- Information required for order: number of teeth, module, pressure angle and larence grade of splines

CARBIDE MEASURING BALLS



- To measure angle and diameter of taper holes
- Material: carbide
- Hardness: \geq HRA87
- Diameter accuracy: $\pm 3\mu\text{m}$
- Roundness: $1\mu\text{m}$
- Supplied with manufacturer inspection certificate



4172-20

Individual

Code	Diameter
4172-2	2mm
4172-2D5	2.5mm
4172-3	3mm
4172-3D5	3.5mm
4172-4	4mm
4172-4D5	4.5mm
4172-5	5mm
4172-6	6mm
4172-6D5	6.5mm
4172-8	8mm

Individual

Code	Diameter
4172-8D5	8.5mm
4172-10	10mm
4172-12	12mm
4172-14	14mm
4172-15	15mm
4172-16	16mm
4172-18	18mm
4172-20	20mm
4172-30	30mm

Set (19 pairs)

Code	Carbide balls included (one pair per size)
4172-S19	2mm, 2.5mm, 3mm, 3.5mm, 4mm, 4.5mm, 5mm, 6mm, 6.5mm, 8mm, 8.5mm, 10mm, 12mm, 14mm, 15mm, 16mm, 18mm, 20mm, 30mm

Calculate angle (α) and diameter (D_{max}) according to the ball diameter (d_1 , d_2), height (A) and depth (B)

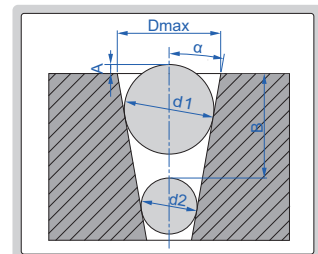



CERAMIC MEASURING BALLS



4190-40D000

- Zirconia material, high strength and hardness, extremely wear resistance and corrosion resistance, good insulation, antistatic and magnetic resistance
- Mirror surface without holes
- Supplied with manufacturer inspection certificate

Individual

Code	Diameter	Accuracy	Roundness
4190-1D000	1.000mm	±2µm	0.5µm
4190-1D200	1.200mm	±2µm	0.5µm
4190-1D300	1.300mm	±2µm	0.5µm
4190-1D340	1.340mm	±2µm	0.5µm
4190-1D500	1.500mm	±2µm	0.5µm
4190-1D588	1.588mm (1/16")	±2µm	0.5µm
4190-1D750	1.750mm	±2µm	0.5µm
4190-2D000	2.000mm	±2µm	0.5µm
4190-2D381	2.381mm (3/32")	±2µm	0.5µm
4190-2D500	2.500mm	±2µm	0.5µm
4190-2D778	2.778mm (7/64")	±2µm	0.5µm
4190-3D000	3.000mm	±2µm	0.5µm
4190-3D175	3.175mm (1/8")	±2µm	0.5µm
4190-3D500	3.500mm	±2µm	0.5µm
4190-3D969	3.969mm (5/32")	±2µm	0.5µm
4190-4D000	4.000mm	±2µm	0.5µm
4190-4D500	4.500mm	±2µm	0.5µm
4190-4D763	4.763mm (3/16")	±2µm	0.5µm
4190-5D000	5.000mm	±2µm	0.5µm
4190-5D556	5.556mm (7/32")	±2µm	0.5µm
4190-5D953	5.953mm (15/64")	±2µm	0.5µm
4190-6D000	6.000mm	±2µm	0.5µm
4190-6D350	6.350mm (1/4")	±2µm	0.5µm
4190-6D500	6.500mm	±2µm	0.5µm
4190-6D747	6.747mm (17/64")	±2µm	0.5µm
4190-7D000	7.000mm	±2µm	0.5µm
4190-7D144	7.144mm (9/32")	±2µm	0.5µm
4190-7D500	7.500mm	±2µm	0.5µm
4190-7D938	7.938mm (5/16")	±2µm	0.5µm
4190-8D000	8.000mm	±2µm	0.5µm
4190-8D731	8.731mm (11/32")	±2µm	0.5µm

Individual

Code	Diameter	Accuracy	Roundness
4190-9D525	9.525mm (3/8")	±2µm	0.5µm
4190-10D000	10.000mm	±2µm	0.5µm
4190-10D318	10.318mm (13/32")	±2µm	0.5µm
4190-11D000	11.000mm	±2µm	0.5µm
4190-11D113	11.113mm (7/16")	±2µm	0.5µm
4190-11D509	11.509mm (29/64")	±2µm	0.5µm
4190-11D906	11.906mm (15/32")	±2µm	0.5µm
4190-12D000	12.000mm	±2µm	0.5µm
4190-12D303	12.303mm (31/64")	±2µm	0.5µm
4190-12D700	12.700mm (1/2")	±2µm	0.5µm
4190-13D000	13.000mm	±2µm	0.6µm
4190-13D494	13.494mm (17/32")	±2µm	0.6µm
4190-14D000	14.000mm	±2µm	0.6µm
4190-14D288	14.288mm (9/16")	±2µm	0.6µm
4190-15D000	15.000mm	±2µm	0.6µm
4190-15D081	15.081mm (19/32")	±2.5µm	0.6µm
4190-15D875	15.875mm (5/8")	±2.5µm	0.6µm
4190-16D000	16.000mm	±2.5µm	0.6µm
4190-16D669	16.669mm (21/32")	±2.5µm	0.6µm
4190-17D462	17.462mm (11/16")	±2.5µm	0.6µm
4190-18D000	18.000mm	±2.5µm	0.6µm
4190-18D256	18.256mm (23/32")	±2.5µm	0.6µm
4190-19D050	19.050mm (3/4")	±2.5µm	0.6µm
4190-19D844	19.844mm (25/32")	±2.5µm	0.6µm
4190-20D000	20.000mm	±2.5µm	0.6µm
4190-22D000	22.000mm	±2.5µm	1µm
4190-22D225	22.225mm (7/8")	±2.5µm	1µm
4190-23D812	23.812mm (15/16")	±2.5µm	1µm
4190-25D000	25.000mm	±2.5µm	1µm
4190-40D000	40.000mm	±2.5µm	1.5µm

Set (25 pairs)

Code	Ceramic balls included (one pair per size)
4190-S25	1, 1.5, 2, 2.5, 3, 3.5, 4, 4.5, 5, 6, 6.5, 7, 7.5, 8, 10, 11, 12, 13, 14, 15, 16, 18, 20, 22, 25mm

STEEL MEASURING BALLS



- To measure angle and diameter of taper holes
- Material: tool steel
- Hardness: HRC63
- Diameter accuracy: $\pm 3\mu\text{m}$
- Roundness: $1\mu\text{m}$
- Supplied with manufacturer inspection certificate



4168-S25

calculate angle (α) and diameter (D_{max}) according to the ball diameter (d_1 , d_2), height (A) and depth (B)

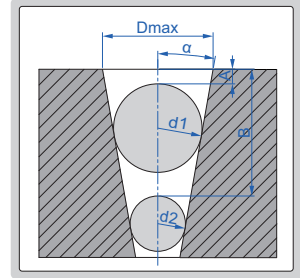

Individual

Code	Diameter
4168-01	1mm
4168-02	2mm
4168-03	3mm
4168-04	4mm
4168-05	5mm
4168-06	6mm
4168-07	7mm
4168-08	8mm
4168-09	9mm
4168-10	10mm
4168-11	11mm
4168-12	12mm
4168-13	13mm

Individual

Code	Diameter
4168-14	14mm
4168-15	15mm
4168-16	16mm
4168-17	17mm
4168-18	18mm
4168-19	19mm
4168-20	20mm
4168-21	21mm
4168-22	22mm
4168-23	23mm
4168-24	24mm
4168-25	25mm

Set (25 pairs)

Code	Steel balls included (one pair per size)
4168-S25	1, 2, 3, 4, 5, 6, 7, 8, 9, 10, 11, 12, 13, 14, 15, 16, 17, 18, 19, 20, 21, 22, 23, 24, 25mm

THREADED HOLE LOCATION GAUGES



ANY SIZE WITHIN THE RANGE OF M3-M150MM CAN BE CUSTOMIZED

ACCURACY CLASS CAN BE CUSTOMIZED



12

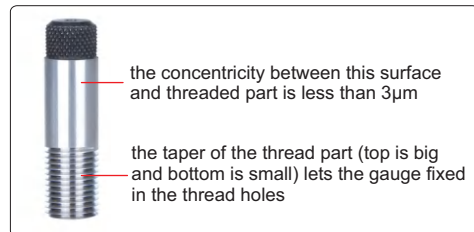

4662-12R



4662-3

Unit: mm

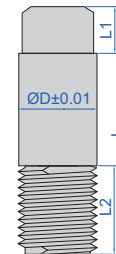

- Hardness: HRC60-63

application

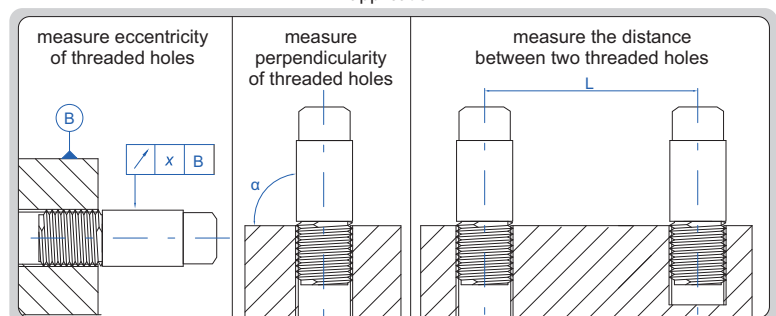

(mm)					
Code	Size	L	L1	L2	ØD
4662-3	M3×0.5-6H	29	8	6	3
4662-4	M4×0.7-6H	31.4	8	8.4	4
4662-5	M5×0.8-6H	32.6	8	9.6	5
4662-6	M6×1-6H	47	10	12	6
4662-8	M8×1.25-6H	50	10	15	8
4662-8P	M8×1-6H	47	10	12	8
4662-10	M10×1.5-6H	53	10	18	10
4662-10P	M10×1-6H	47	10	12	10
4662-12	M12×1.75-6H	56	10	21	12
4662-12P	M12×1-6H	47	10	12	12
4662-12R	M12×1.5-6H	53	10	18	12
4662-14	M14×2-6H	59	10	24	14
4662-14P	M14×1-6H	47	10	12	14
4662-14R	M14×1.5-6H	53	10	18	14
4662-16	M16×2-6H	59	10	24	16
4662-16P	M16×1-6H	47	10	12	16
4662-16R	M16×1.5-6H	53	10	18	16
4662-20	M20×2.5-6H	65	10	30	20
4662-20P	M20×1-6H	47	10	12	20
4662-20R	M20×1.5-6H	53	10	18	20

ATTENTION: ONLY FOR THE WORKPIECES THAT THE CHAMFER IS CONCENTRIC WITH THE SCREW PART

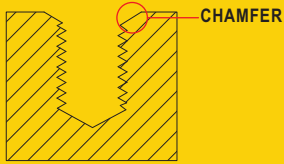

THREADED HOLE LOCATION GAUGES

INSIZE PLUS
MADE IN EUROPE



4676-12

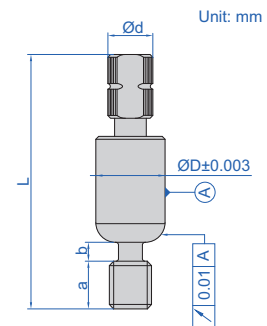

- Only for the workpieces that the chamfer is concentric with the screw part

application

there is a R-shaped guide, which leads the gauge to the center of the threaded holes by fitting the R-shaped guide on the chamfer of the threaded holes

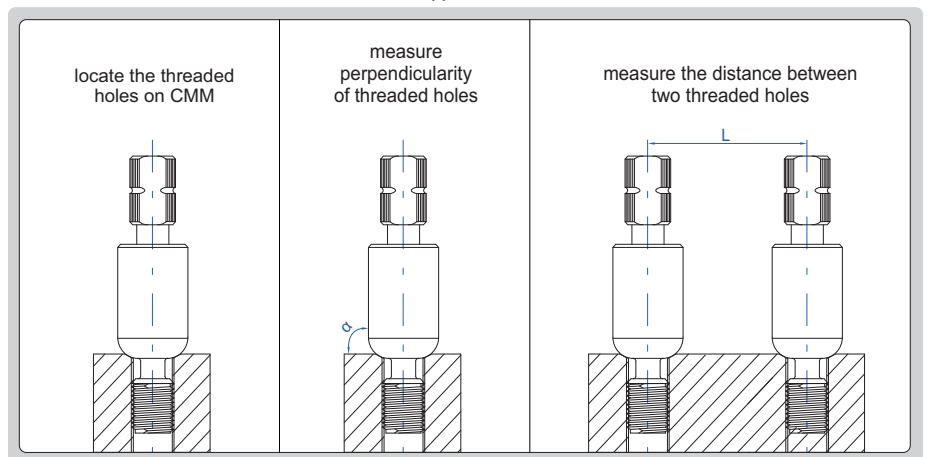
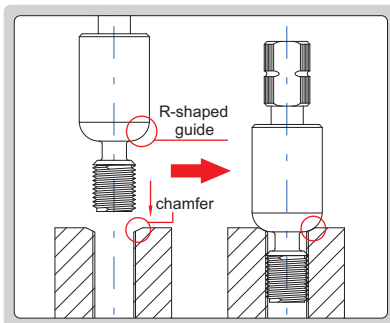

(mm)

Code	Size	Ød	ØD	a	b	L
4676-3	M3×0.5	4	7	4	2	26
4676-4	M4×0.7	4	7	4	2	26
4676-5	M5×0.8	5.5	9	6	2	33
4676-6	M6×1.0	5.5	9	6	2	33
4676-8	M8×1.25	8.5	13	9	3.5	48
4676-10	M10×1.5	8.5	13	9	3.5	48
4676-12	M12×1.75	12	17	10	3.5	55

DIGITAL THREAD DEPTH GAUGES

INSIZE PLUS
MADE IN EUROPE

**INSPECTION
CERTIFICATE**

DATA
OUTPUT



4649-6

- Supplied with GO and NO-GO gauges together
- Check GO and NO-GO while measuring the depth of thread holes
- Resolution: 0.01mm/0.0005"
- Depth 0-40mm: accuracy ± 0.04 mm;
Depth 40-80mm: accuracy ± 0.06 mm
- Data output
- Button function: on/off, inch/metric conversion, reading hold, data preset, absolute/incremental measurement
- Battery CR2032, automatic power off, move the digital unit to turn on power
- The GO gauge can be replaced after wear
- Optional accessory: data output cable (code **7302-85**), zero block (code **4668-SETTER**), removal tool (code **4668-TOOL**)

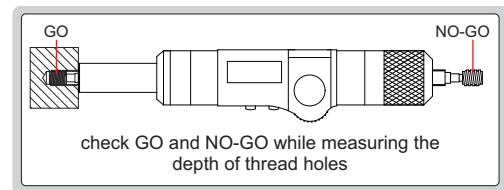
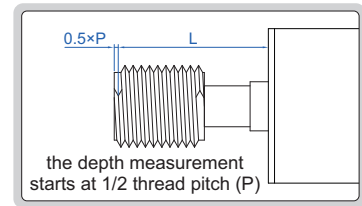

12

Metric thread

Code	Size (mm)	Depth range
4649-2 *	M2x0.4-6H	0-8mm
4649-2D5 *	M2.5x0.45-6H	0-10mm
4649-3 *	M3x0.5-6H	0-12mm
4649-3D5 *	M3.5x0.6-6H	0-14mm
4649-4 *	M4x0.7-6H	0-16mm
4649-5 *	M5x0.8-6H	0-20mm
4649-6 *	M6x1-6H	0-24mm
4649-7 *	M7x1-6H	0-28mm
4649-8 *	M8x1.25-6H	0-32mm
4649-10 *	M10x1.5-6H	0-40mm
4649-12 *	M12x1.75-6H	0-48mm
4649-14 *	M14x2-6H	0-56mm
4649-16 *	M16x2-6H	0-64mm
4649-18 *	M18x2.5-6H	0-72mm
4649-20 *	M20x2.5-6H	0-80mm
4649-22 *	M22x2.5-6H	0-80mm
4649-24 *	M24x3-6H	0-80mm
4649-27 *	M27x3-6H	0-80mm
4649-30 *	M30x3.5-6H	0-80mm

Metric fine thread

Code	Size (mm)	Depth range
4649-8P *	M8x1-6H	0-32mm
4649-10P *	M10x1-6H	0-40mm
4649-10T *	M10x1.25-6H	0-40mm
4649-12P *	M12x1-6H	0-48mm
4649-12T *	M12x1.25-6H	0-48mm
4649-12R *	M12x1.5-6H	0-48mm
4649-14P *	M14x1-6H	0-56mm
4649-14T *	M14x1.25-6H	0-56mm
4649-14R *	M14x1.5-6H	0-56mm
4649-16P *	M16x1-6H	0-64mm
4649-16R *	M16x1.5-6H	0-64mm
4649-18P *	M18x1-6H	0-72mm
4649-18R *	M18x1.5-6H	0-72mm
4649-20P *	M20x1-6H	0-80mm
4649-20R *	M20x1.5-6H	0-80mm
4649-22P *	M22x1-6H	0-80mm
4649-22R *	M22x1.5-6H	0-80mm
4649-24P *	M24x1-6H	0-80mm
4649-24R *	M24x1.5-6H	0-80mm

* Supplied with manufacturer inspection certificate

THREAD DEPTH GAUGES

INSIZE PLUS
MADE IN EUROPE

**INSPECTION
CERTIFICATE**



4666-6

- Supplied with GO and NO-GO gauges together
- Check GO and NO-GO while measuring the depth thread holes
- The GO gauge can be replaced after wear
- Optional accessory: zero block (code 4668-SETTER), removal tool (code 4668-TOOL)



4666-14PA

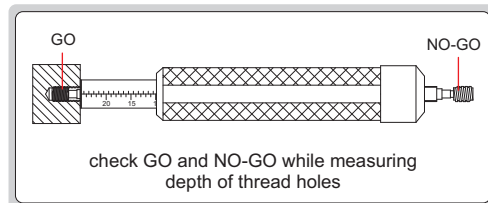
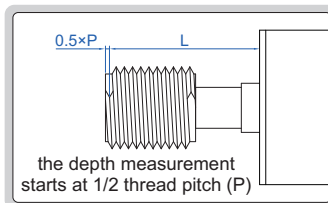

Metric thread (without vernier reading, graduation: 0.5mm, accuracy: ±0.25mm)

Code	Size (mm)	Depth range
4666-2*	M2x0.4-6H	0-8mm
4666-2D5*	M2.5x0.45-6H	0-10mm
4666-3*	M3x0.5-6H	0-11mm
4666-3D5*	M3.5x0.6-6H	0-14mm
4666-4*	M4x0.7-6H	0-15mm
4666-5*	M5x0.8-6H	0-20mm
4666-6*	M6x1-6H	0-24mm
4666-7*	M7x1-6H	0-28mm
4666-8*	M8x1.25-6H	0-32mm
4666-10*	M10x1.5-6H	0-40mm
4666-12*	M12x1.75-6H	0-48mm
4666-14*	M14x2-6H	0-56mm
4666-16*	M16x2-6H	0-64mm
4666-18*	M18x2.5-6H	0-72mm
4666-20*	M20x2.5-6H	0-80mm
4666-22*	M22x2.5-6H	0-80mm
4666-24*	M24x3-6H	0-80mm
4666-27*	M27x3-6H	0-80mm
4666-30*	M30x3.5-6H	0-80mm

Metric thread (with vernier reading, graduation: 0.1mm, accuracy: ±0.1mm)

Code	Size (mm)	Depth range
4666-2A*	M2x0.4-6H	0-8mm
4666-2D5A*	M2.5x0.45-6H	0-10mm
4666-3A*	M3x0.5-6H	0-11mm
4666-3D5A*	M3.5x0.6-6H	0-14mm
4666-4A*	M4x0.7-6H	0-15mm
4666-5A*	M5x0.8-6H	0-20mm
4666-6A*	M6x1-6H	0-24mm
4666-7A*	M7x1-6H	0-28mm
4666-8A*	M8x1.25-6H	0-32mm
4666-10A*	M10x1.5-6H	0-40mm
4666-12A*	M12x1.75-6H	0-48mm
4666-14A*	M14x2-6H	0-56mm
4666-16A*	M16x2-6H	0-64mm
4666-18A*	M18x2.5-6H	0-72mm
4666-20A*	M20x2.5-6H	0-80mm
4666-22A*	M22x2.5-6H	0-80mm
4666-24A*	M24x3-6H	0-80mm
4666-27A*	M27x3-6H	0-80mm
4666-30A*	M30x3.5-6H	0-80mm



Metric fine thread (without vernier reading, graduation: 0.5mm, accuracy: ±0.25mm)

Code	Size (mm)	Depth range
4666-8P*	M8x1-6H	0-32mm
4666-10P*	M10x1-6H	0-40mm
4666-10T*	M10x1.25-6H	0-40mm
4666-12P*	M12x1-6H	0-48mm
4666-12T*	M12x1.25-6H	0-48mm
4666-12R*	M12x1.5-6H	0-48mm
4666-14P*	M14x1-6H	0-56mm
4666-14T*	M14x1.25-6H	0-56mm
4666-14R*	M14x1.5-6H	0-56mm
4666-16P*	M16x1-6H	0-64mm
4666-16R*	M16x1.5-6H	0-64mm
4666-18P*	M18x1-6H	0-72mm
4666-18R*	M18x1.5-6H	0-72mm
4666-20P*	M20x1-6H	0-80mm
4666-20R*	M20x1.5-6H	0-80mm
4666-22P*	M22x1-6H	0-80mm
4666-22R*	M22x1.5-6H	0-80mm
4666-24P*	M24x1-6H	0-80mm
4666-24R*	M24x1.5-6H	0-80mm

Metric fine thread (with vernier reading, graduation: 0.1mm, accuracy: ±0.1mm)

Code	Size (mm)	Depth range
4666-8PA*	M8x1-6H	0-32mm
4666-10PA*	M10x1-6H	0-40mm
4666-10TA*	M10x1.25-6H	0-40mm
4666-12PA*	M12x1-6H	0-48mm
4666-12TA*	M12x1.25-6H	0-48mm
4666-12RA*	M12x1.5-6H	0-48mm
4666-14PA*	M14x1-6H	0-56mm
4666-14TA*	M14x1.25-6H	0-56mm
4666-14RA*	M14x1.5-6H	0-56mm
4666-16PA*	M16x1-6H	0-64mm
4666-16RA*	M16x1.5-6H	0-64mm
4666-18PA*	M18x1-6H	0-72mm
4666-18RA*	M18x1.5-6H	0-72mm
4666-20PA*	M20x1-6H	0-80mm
4666-20RA*	M20x1.5-6H	0-80mm
4666-22PA*	M22x1-6H	0-80mm
4666-22RA*	M22x1.5-6H	0-80mm
4666-24PA*	M24x1-6H	0-80mm
4666-24RA*	M24x1.5-6H	0-80mm

* Supplied with manufacturer inspection certificate

DLC COATED THREAD RING GAUGES AND PLUG GAUGES



DLC coated GO ring gauge



DLC coated GO plug gauge

- The DLC coating has the following advantages:
 - High hardness, extremely wear resistance
 - Low friction coefficient
 - Corrosion resistance
- Plug gauges: GO is coated, NO-GO is not;
Ring gauges: GO is coated, NO-GO is not
- The following thread ring gauges and plug gauges are available with DLC coating:
 - Metric fine thread ring gauges and plug gauges (**4139, 4129** series);
 - Metric thread ring gauges and plug gauges (**4130, 4120** series);
 - American standard thread ring gauges and plug gauges (**4131, 4121** series)

Code example:

Original code	DLC coating code
4120-12	4120-12-DLC
4130-4	4130-4-DLC

DLC coating characteristics

Hardness	6000HV
Friction coefficient	0.15
Coating color	interference color

METRIC THREAD PLUG GAUGES

WARNING: LIFE TIME IS LIMITED, CAN BE USED ABOUT 2000 TIMES

- Supplied with Go and No-Go gauges together
- Standard ISO1502
- Supplied with manufacturer inspection certificate



4130-10



Individual

Size (mm)		Code		
Nominal diameter	Pitch	Class 6H	Class 6G	Class 4H
M0.8	0.2	4130-D8	4130-D8G	4130-D8H
M0.9	0.225	4130-D9	4130-D9G	4130-D9H
M1	0.25	4130-1	4130-1G	4130-1H
M1.1	0.25	4130-1D1	4130-1D1G	4130-1D1H
M1.2	0.25	4130-1D2	4130-1D2G	4130-1D2H
M1.4	0.3	4130-1D4	4130-1D4G	4130-1D4H
M1.6	0.35	4130-1D6	4130-1D6G	4130-1D6H
M1.7	0.35	4130-1D7	4130-1D7G	4130-1D7H
M1.8	0.35	4130-1D8	4130-1D8G	4130-1D8H
M2	0.4	4130-2	4130-2G	4130-2H
M2.2	0.45	4130-2D2	4130-2D2G	4130-2D2H
M2.3	0.4	4130-2D3	4130-2D3G	4130-2D3H
M2.5	0.45	4130-2D5	4130-2D5G	4130-2D5H
M2.6	0.45	4130-2D6	4130-2D6G	4130-2D6H
M3	0.5	4130-3	4130-3G	4130-3H
M3.5	0.6	4130-3D5	4130-3D5G	4130-3D5H
M4	0.7	4130-4	4130-4G	4130-4H
M4.5	0.75	4130-4D5	4130-4D5G	4130-4D5H
M5	0.8	4130-5	4130-5G	4130-5H
M6	1	4130-6	4130-6G	4130-6H
M7	1	4130-7	4130-7G	4130-7H
M8	1.25	4130-8	4130-8G	4130-8H

Individual

Size (mm)		Code		
Nominal diameter	Pitch	Class 6H	Class 6G	Class 4H
M9	1.25	4130-9	4130-9G	4130-9H
M10	1.5	4130-10	4130-10G	4130-10H
M11	1.5	4130-11	4130-11G	4130-11H
M12	1.75	4130-12	4130-12G	4130-12H
M14	2	4130-14	4130-14G	4130-14H
M16	2	4130-16	4130-16G	4130-16H
M18	2.5	4130-18	4130-18G	4130-18H
M20	2.5	4130-20	4130-20G	4130-20H
M22	2.5	4130-22	4130-22G	4130-22H
M24	3	4130-24	4130-24G	4130-24H
M27	3	4130-27	4130-27G	4130-27H
M30	3.5	4130-30	4130-30G	4130-30H
M33	3.5	4130-33	4130-33G	4130-33H
M36	4	4130-36	4130-36G	4130-36H
M39	4	4130-39	4130-39G	4130-39H
M42	4.5	4130-42	4130-42G	4130-42H
M45	4.5	4130-45	4130-45G	4130-45H
M48	5	4130-48	4130-48G	4130-48H
M52	5	4130-52	4130-52G	4130-52H
M56	5.5	4130-56	4130-56G	4130-56H
M60	5.5	4130-60	4130-60G	4130-60H
M64	6	4130-64	4130-64G	4130-64H
M68	6	4130-68	4130-68G	4130-68H

Set (class 6H)

Code	Thread plug gauges included (mm)
4130-S7	M3x0.5 (4130-3), M4x0.7 (4130-4), M5x0.8 (4130-5), M6x1 (4130-6), M8x1.25 (4130-8), M10x1.5 (4130-10), M12x1.75 (4130-12)

WARNING: LIFE TIME IS LIMITED,
CAN BE USED ABOUT 2000 TIMES



METRIC FINE THREAD PLUG GAUGES



4139-20G

- Supplied with Go and No-Go gauges together
- Standard ISO1502
- Supplied with manufacturer inspection certificate

Code example:
"-1A" stands for "4139-1A"

Size (mm)		Code (4139)		
Nominal diameter	Pitch	Class 6H	Class 6G	Class 4H
M1	0.2	-1A	-1AG	-1AH
M1.2	0.2	-1D2A	-1D2AG	-1D2AH
M1.4	0.2	-1D4A	-1D4AG	-1D4AH
M1.6	0.2	-1D6A	-1D6AG	-1D6AH
M1.8	0.2	-1D8A	-1D8AG	-1D8AH
M2	0.2	-2A	-2AG	-2AH
	0.25	-2B	-2BG	-2BH
M2.5	0.2	-2D5A	-2D5AG	-2D5AH
	0.25	-2D5B	-2D5BG	-2D5BH
	0.35	-2D5D	-2D5DG	-2D5DH
M3	0.25	-3B	-3BG	-3BH
	0.35	-3D	-3DG	-3DH
M3.5	0.25	-3D5B	-3D5BG	-3D5BH
	0.35	-3D5D	-3D5DG	-3D5DH
	0.5	-3D5G	-3D5GG	-3D5GH
M4	0.25	-4B	-4BG	-4BH
	0.35	-4D	-4DG	-4DH
	0.5	-4G	-4GG	-4GH
M4.5	0.35	-4D5D	-4D5DG	-4D5DH
	0.5	-4D5G	-4D5GG	-4D5GH
M5	0.25	-5B	-5BG	-5BH
	0.35	-5D	-5DG	-5DH
	0.5	-5G	-5GG	-5GH
M5.5	0.5	-5D5G	-5D5GG	-5D5GH
M6	0.25	-6B	-6BG	-6BH
	0.35	-6D	-6DG	-6DH
M6.5	0.5	-6G	-6GG	-6GH
	0.5	-6D5G	-6D5GG	-6D5GH
M7	0.35	-7D	-7DG	-7DH
	0.5	-7G	-7GG	-7GH
M7.5	0.5	-7D5G	-7D5GG	-7D5GH
M8	0.35	-8D	-8DG	-8DH
	0.5	-8G	-8GG	-8GH

Size (mm)		Code (4139)		
Nominal diameter	Pitch	Class 6H	Class 6G	Class 4H
M8	1	-8P	-8PG	-8PH
M8.5	0.5	-8D5G	-8D5GG	-8D5GH
	0.35	-9D	-9DG	-9DH
M9	0.5	-9G	-9GG	-9GH
	0.75	-9L	-9LG	-9LH
	1	-9P	-9PG	-9PH
M10	0.35	-10D	-10DG	-10DH
	0.5	-10G	-10GG	-10GH
	1	-10P	-10PG	-10PH
	1.25	-10Q	-10QG	-10QH
M11	0.5	-11G	-11GG	-11GH
	1	-11P	-11PG	-11PH
M12	0.5	-12G	-12GG	-12GH
	1	-12P	-12PG	-12PH
	1.25	-12Q	-12QG	-12QH
	1.5	-12R	-12RG	-12RH
M13	0.5	-13G	-13GG	-13GH
	1	-13P	-13PG	-13PH
	1.5	-13R	-13RG	-13RH
M14	0.5	-14G	-14GG	-14GH
	1	-14P	-14PG	-14PH
	1.25	-14Q	-14QG	-14QH
M15	1.5	-14R	-14RG	-14RH
	0.5	-15G	-15GG	-15GH
	1	-15P	-15PG	-15PH
M16	1.5	-15R	-15RG	-15RH
	0.5	-16G	-16GG	-16GH
	1	-16P	-16PG	-16PH
M17	1.25	-16Q	-16QG	-16QH
	1.5	-16R	-16RG	-16RH
	0.5	-17G	-17GG	-17GH
M17	1	-17P	-17PG	-17PH
	1.5	-17R	-17RG	-17RH

To be continued

Continued from previous page

Size (mm)		Code (4139)		
Nominal diameter	Pitch	Class 6H	Class 6G	Class 4H
M18	0.5	-18G	-18GG	-18GH
	1	-18P	-18PG	-18PH
	1.25	-18Q	-18QG	-18QH
	1.5	-18R	-18RG	-18RH
	2	-18T	-18TG	-18TH
M19	0.5	-19G	-19GG	-19GH
	1	-19P	-19PG	-19PH
	1.5	-19R	-19RG	-19RH
M20	0.5	-20G	-20GG	-20GH
	1	-20P	-20PG	-20PH
	1.25	-20Q	-20QG	-20QH
	1.5	-20R	-20RG	-20RH
	2	-20T	-20TG	-20TH
M21	0.5	-21G	-21GG	-21GH
	1	-21P	-21PG	-21PH
	1.5	-21R	-21RG	-21RH
M22	0.5	-22G	-22GG	-22GH
	1	-22P	-22PG	-22PH
	1.25	-22Q	-22QG	-22QH
	1.5	-22R	-22RG	-22RH
M23	0.5	-23G	-23GG	-23GH
	1	-23P	-23PG	-23PH
M24	0.5	-24G	-24GG	-24GH
	1	-24P	-24PG	-24PH
	1.25	-24Q	-24QG	-24QH
	1.5	-24R	-24RG	-24RH
M25	2	-24T	-24TG	-24TH
	0.5	-25G	-25GG	-25GH
	1	-25P	-25PG	-25PH
	1.5	-25R	-25RG	-25RH
M26	2	-25T	-25TG	-25TH
	0.5	-26G	-26GG	-26GH
	1	-26P	-26PG	-26PH
	1.5	-26R	-26RG	-26RH
M27	2	-26T	-26TG	-26TH
	0.5	-27G	-27GG	-27GH
	1	-27P	-27PG	-27PH
	1.5	-27R	-27RG	-27RH
M28	2	-27T	-27TG	-27TH
	0.5	-28G	-28GG	-28GH
	1	-28P	-28PG	-28PH
M29	1.5	-28R	-28RG	-28RH
	2	-28T	-28TG	-28TH
	0.5	-29G	-29GG	-29GH
M30	0.75	-29L	-29LG	-29LH
	1	-29P	-29PG	-29PH
M30	0.5	-30G	-30GG	-30GH
	0.75	-30L	-30LG	-30LH
	1	-30P	-30PG	-30PH
	1.5	-30R	-30RG	-30RH
	2	-30T	-30TG	-30TH
M30	3	-30V	-30VG	-30VH

Size (mm)		Code (4139)		
Nominal diameter	Pitch	Class 6H	Class 6G	Class 4H
M31	0.5	-31G	-31GG	-31GH
	0.75	-31L	-31LG	-31LH
M32	0.5	-32G	-32GG	-32GH
	0.75	-32L	-32LG	-32LH
	1	-32P	-32PG	-32PH
	1.5	-32R	-32RG	-32RH
M33	2	-32T	-32TG	-32TH
	0.5	-33G	-33GG	-33GH
	0.75	-33L	-33LG	-33LH
	1	-33P	-33PG	-33PH
	1.5	-33R	-33RG	-33RH
M34	2	-33T	-33TG	-33TH
	3	-33V	-33VG	-33VH
	0.75	-34L	-34LG	-34LH
	1	-34P	-34PG	-34PH
M35	1.5	-34R	-34RG	-34RH
	2	-34T	-34TG	-34TH
	0.75	-35L	-35LG	-35LH
M36	1	-35P	-35PG	-35PH
	1.5	-35R	-35RG	-35RH
	2	-35T	-35TG	-35TH
	0.75	-36L	-36LG	-36LH
M37	1	-36P	-36PG	-36PH
	1.5	-36R	-36RG	-36RH
	2	-36T	-36TG	-36TH
M38	3	-36V	-36VG	-36VH
	0.75	-37L	-37LG	-37LH
	1	-37P	-37PG	-37PH
	1.5	-37R	-37RG	-37RH
M39	2	-37T	-37TG	-37TH
	0.75	-38L	-38LG	-38LH
	1	-38P	-38PG	-38PH
M40	1.5	-38R	-38RG	-38RH
	2	-38T	-38TG	-38TH
	0.75	-39L	-39LG	-39LH
	1	-39P	-39PG	-39PH
M42	1.5	-39R	-39RG	-39RH
	2	-39T	-39TG	-39TH
	3	-39V	-39VG	-39VH
M45	0.75	-40L	-40LG	-40LH
	1	-40P	-40PG	-40PH
	1.5	-40R	-40RG	-40RH
	2	-40T	-40TG	-40TH
M48	3	-40V	-40VG	-40VH
	1	-42P	-42PG	-42PH
	1.5	-42R	-42RG	-42RH
M45	2	-42T	-42TG	-42TH
	3	-42V	-42VG	-42VH
	1	-45P	-45PG	-45PH
M48	1.5	-45R	-45RG	-45RH
	2	-45T	-45TG	-45TH
	3	-45V	-45VG	-45VH
M48	1	-48P	-48PG	-48PH
	1.5	-48R	-48RG	-48RH
	2	-48T	-48TG	-48TH
M48	3	-48V	-48VG	-48VH

To be continued



Continued from previous page

Size (mm)		Code (4139)		
Nominal diameter	Pitch	Class 6H	Class 6G	Class 4H
M50	1	-50P	-50PG	-50PH
	1.5	-50R	-50RG	-50RH
	2	-50T	-50TG	-50TH
	3	-50V	-50VG	-50VH
M52	1	-52P	-52PG	-52PH
	1.5	-52R	-52RG	-52RH
	2	-52T	-52TG	-52TH
	3	-52V	-52VG	-52VH
	4	-52X	-52XG	-52XH
M55	1	-55P	-55PG	-55PH
	1.5	-55R	-55RG	-55RH
	2	-55T	-55TG	-55TH
	3	-55V	-55VG	-55VH
	4	-55X	-55XG	-55XH
M56	1	-56P	-56PG	-56PH
	1.5	-56R	-56RG	-56RH
	2	-56T	-56TG	-56TH
	3	-56V	-56VG	-56VH
	4	-56X	-56XG	-56XH
M58	1	-58P	-58PG	-58PH
	1.5	-58R	-58RG	-58RH
	2	-58T	-58TG	-58TH
	3	-58V	-58VG	-58VH
	4	-58X	-58XG	-58XH
M60	1	-60P	-60PG	-60PH
	1.5	-60R	-60RG	-60RH
	2	-60T	-60TG	-60TH
	3	-60V	-60VG	-60VH
	4	-60X	-60XG	-60XH
M62	1.5	-62R	-62RG	-62RH
	2	-62T	-62TG	-62TH
	3	-62V	-62VG	-62VH
	4	-62X	-62XG	-62XH
	M64	1.5	-64R	-64RG
2		-64T	-64TG	-64TH
3		-64V	-64VG	-64VH
4		-64X	-64XG	-64XH
M65		1.5	-65R	-65RG
	2	-65T	-65TG	-65TH
	3	-65V	-65VG	-65VH
	4	-65X	-65XG	-65XH
	M68	1.5	-68R	-68RG
2		-68T	-68TG	-68TH
3		-68V	-68VG	-68VH
4		-68X	-68XG	-68XH
M70		1.5	-70R	-70RG
	2	-70T	-70TG	-70TH
	3	-70V	-70VG	-70VH
	4	-70X	-70XG	-70XH
	6	-70O	-70OG	-70OH
M72	1.5	-72R	-72RG	-72RH

Size (mm)		Code (4139)		
Nominal diameter	Pitch	Class 6H	Class 6G	Class 4H
M72	2	-72T	-72TG	-72TH
	3	-72V	-72VG	-72VH
	4	-72X	-72XG	-72XH
	6	-72O	-72OG	-72OH
M75	1.5	-75R	-75RG	-75RH
	2	-75T	-75TG	-75TH
	3	-75V	-75VG	-75VH
	4	-75X	-75XG	-75XH
	M76	1.5	-76R	-76RG
2		-76T	-76TG	-76TH
3		-76V	-76VG	-76VH
4		-76X	-76XG	-76XH
6		-76O	-76OG	-76OH
M78	2	-78T	-78TG	-78TH
M80	1.5	-80R	-80RG	-80RH
	2	-80T	-80TG	-80TH
	3	-80V	-80VG	-80VH
	4	-80X	-80XG	-80XH
	6	-80O	-80OG	-80OH
M82	2	-82T	-82TG	-82TH
M85	2	-85T	-85TG	-85TH
	3	-85V	-85VG	-85VH
	4	-85X	-85XG	-85XH
	6	-85O	-85OG	-85OH
	M90	2	-90T	-90TG
3		-90V	-90VG	-90VH
4		-90X	-90XG	-90XH
6		-90O	-90OG	-90OH
M95		2	-95T	-95TG
	3	-95V	-95VG	-95VH
	4	-95X	-95XG	-95XH
	6	-95O	-95OG	-95OH
	M100	2	-100T	-100TG
3		-100V	-100VG	-100VH
4		-100X	-100XG	-100XH
6		-100O	-100OG	-100OH
M105		2	-105T	-105TG
	3	-105V	-105VG	-105VH
	4	-105X	-105XG	-105XH
	6	-105O	-105OG	-105OH
	M110	2	-110T	-110TG
3		-110V	-110VG	-110VH
4		-110X	-110XG	-110XH
6		-110O	-110OG	-110OH
M115		2	-115T	-115TG
	3	-115V	-115VG	-115VH
	4	-115X	-115XG	-115XH
	6	-115O	-115OG	-115OH
	M120	2	-120T	-120TG
3		-120V	-120VG	-120VH
4		-120X	-120XG	-120XH
6		-120O	-120OG	-120OH

METRIC THREAD RING GAUGES

WARNING: LIFE TIME IS LIMITED, CAN BE USED ABOUT 2000 TIMES



- Standard ISO1502
- Supplied with manufacturer inspection certificate



4120-16



4120-16N

Code example:
"-2" stands for "4120-2"

Individual

Size (mm)		Code (4120)					
		Class 6g		Class 6e		Class 6h	
Nominal diameter	Pitch	GO	NOGO	GO	NOGO	GO	NOGO
M2	0.4	-2	-2N	-2E	-2EN	-2H	-2HN
M2.2	0.45	-2D2	-2D2N	-2D2E	-2D2EN	-2D2H	-2D2HN
M2.3	0.4	-2D3	-2D3N	-2D3E	-2D3EN	-2D3H	-2D3HN
M2.5	0.45	-2D5	-2D5N	-2D5E	-2D5EN	-2D5H	-2D5HN
M2.6	0.45	-2D6	-2D6N	-2D6E	-2D6EN	-2D6H	-2D6HN
M3	0.5	-3	-3N	-3E	-3EN	-3H	-3HN
M3.5	0.6	-3D5	-3D5N	-3D5E	-3D5EN	-3D5H	-3D5HN
M4	0.7	-4	-4N	-4E	-4EN	-4H	-4HN
M4.5	0.75	-4D5	-4D5N	-4D5E	-4D5EN	-4D5H	-4D5HN
M5	0.8	-5	-5N	-5E	-5EN	-5H	-5HN
M6	1	-6	-6N	-6E	-6EN	-6H	-6HN
M7	1	-7	-7N	-7E	-7EN	-7H	-7HN
M8	1.25	-8	-8N	-8E	-8EN	-8H	-8HN
M9	1.25	-9	-9N	-9E	-9EN	-9H	-9HN
M10	1.5	-10	-10N	-10E	-10EN	-10H	-10HN
M11	1.5	-11	-11N	-11E	-11EN	-11H	-11HN
M12	1.75	-12	-12N	-12E	-12EN	-12H	-12HN
M14	2	-14	-14N	-14E	-14EN	-14H	-14HN
M16	2	-16	-16N	-16E	-16EN	-16H	-16HN
M18	2.5	-18	-18N	-18E	-18EN	-18H	-18HN
M20	2.5	-20	-20N	-20E	-20EN	-20H	-20HN
M22	2.5	-22	-22N	-22E	-22EN	-22H	-22HN
M24	3	-24	-24N	-24E	-24EN	-24H	-24HN
M27	3	-27	-27N	-27E	-27EN	-27H	-27HN
M30	3.5	-30	-30N	-30E	-30EN	-30H	-30HN
M33	3.5	-33	-33N	-33E	-33EN	-33H	-33HN
M36	4	-36	-36N	-36E	-36EN	-36H	-36HN
M39	4	-39	-39N	-39E	-39EN	-39H	-39HN
M42	4.5	-42	-42N	-42E	-42EN	-42H	-42HN
M45	4.5	-45	-45N	-45E	-45EN	-45H	-45HN
M48	5	-48	-48N	-48E	-48EN	-48H	-48HN
M52	5	-52	-52N	-52E	-52EN	-52H	-52HN
M56	5.5	-56	-56N	-56E	-56EN	-56H	-56HN
M60	5.5	-60	-60N	-60E	-60EN	-60H	-60HN
M64	6	-64	-64N	-64E	-64EN	-64H	-64HN
M68	6	-68	-68N	-68E	-68EN	-68H	-68HN

Go ring gauge set (Class 6g)

Code	Thread ring gauges included (mm)
4120-S7	M3x0.5 (4120-3), M4x0.7 (4120-4), M5x0.8 (4120-5), M6x1 (4120-6), M8x1.25 (4120-8), M10x1.5 (4120-10), M12x1.75 (4120-12)

No Go ring gauge set (Class 6g)

Code	Thread ring gauges included (mm)
4120-S7N	M3x0.5 (4120-3N), M4x0.7 (4120-4N), M5x0.8 (4120-5N), M6x1 (4120-6N), M8x1.25 (4120-8N), M10x1.5 (4120-10N), M12x1.75 (4120-12N)



WARNING: LIFE TIME IS LIMITED,
CAN BE USED ABOUT 2000 TIMES

METRIC FINE THREAD RING GAUGES

- Standard ISO1502
- Supplied with manufacturer inspection certificate (except gauges larger than M100)



4129-10P



4129-10PN

Code example:
"-3D5G" stands for "4129-3D5G"

Size (mm)		Code (4129)					
Nominal diameter	Pitch	Class 6g		Class 6e		Class 6h	
		GO	NOGO	GO	NOGO	GO	NOGO
M3.5	0.5	-3D5G	-3D5GN	-3D5GE	-3D5GEN	-3D5GH	-3D5GHN
M4	0.5	-4G	-4GN	-4GE	-4GEN	-4GH	-4GHN
M4.5	0.5	-4D5G	-4D5GN	-4D5GE	-4D5GEN	-4D5GH	-4D5GHN
M5	0.5	-5G	-5GN	-5GE	-5GEN	-5GH	-5GHN
M5.5	0.5	-5D5G	-5D5GN	-5D5GE	-5D5GEN	-5D5GH	-5D5GHN
M6	0.5	-6G	-6GN	-6GE	-6GEN	-6GH	-6GHN
	0.75	-6L	-6LN	-6LE	-6LEN	-6LH	-6LHN
M6.5	0.5	-6D5G	-6D5GN	-6D5GE	-6D5GEN	-6D5GH	-6D5GHN
M7	0.5	-7G	-7GN	-7GE	-7GEN	-7GH	-7GHN
	0.75	-7L	-7LN	-7LE	-7LEN	-7LH	-7LHN
M7.5	0.5	-7D5G	-7D5GN	-7D5GE	-7D5GEN	-7D5GH	-7D5GHN
M8	0.5	-8G	-8GN	-8GE	-8GEN	-8GH	-8GHN
	0.75	-8L	-8LN	-8LE	-8LEN	-8LH	-8LHN
	1	-8P	-8PN	-8PE	-8PEN	-8PH	-8PHN
M8.5	0.5	-8D5G	-8D5GN	-8D5GE	-8D5GEN	-8D5GH	-8D5GHN
M9	0.5	-9G	-9GN	-9GE	-9GEN	-9GH	-9GHN
	0.75	-9L	-9LN	-9LE	-9LEN	-9LH	-9LHN
	1	-9P	-9PN	-9PE	-9PEN	-9PH	-9PHN
M10	0.5	-10G	-10GN	-10GE	-10GEN	-10GH	-10GHN
	0.75	-10L	-10LN	-10LE	-10LEN	-10LH	-10LHN
	1	-10P	-10PN	-10PE	-10PEN	-10PH	-10PHN
	1.25	-10Q	-10QN	-10QE	-10QEN	-10QH	-10QHN
M11	0.5	-11G	-11GN	-11GE	-11GEN	-11GH	-11GHN
	0.75	-11L	-11LN	-11LE	-11LEN	-11LH	-11LHN
	1	-11P	-11PN	-11PE	-11PEN	-11PH	-11PHN
M12	0.5	-12G	-12GN	-12GE	-12GEN	-12GH	-12GHN
	0.75	-12L	-12LN	-12LE	-12LEN	-12LH	-12LHN
	1	-12P	-12PN	-12PE	-12PEN	-12PH	-12PHN
	1.25	-12Q	-12QN	-12QE	-12QEN	-12QH	-12QHN
M13	1.5	-12R	-12RN	-12RE	-12REN	-12RH	-12RHN
	0.5	-13G	-13GN	-13GE	-13GEN	-13GH	-13GHN
	0.75	-13L	-13LN	-13LE	-13LEN	-13LH	-13LHN
M14	1	-13P	-13PN	-13PE	-13PEN	-13PH	-13PHN
	1.5	-13R	-13RN	-13RE	-13REN	-13RH	-13RHN
	0.5	-14G	-14GN	-14GE	-14GEN	-14GH	-14GHN
	0.75	-14L	-14LN	-14LE	-14LEN	-14LH	-14LHN
M14	1	-14P	-14PN	-14PE	-14PEN	-14PH	-14PHN
	1.25	-14Q	-14QN	-14QE	-14QEN	-14QH	-14QHN
	1.5	-14R	-14RN	-14RE	-14REN	-14RH	-14RHN

To be continued

Continued from previous page

Size (mm)		Code (4129)					
		Class 6g		Class 6e		Class 6h	
Nominal diameter	Pitch	GO	NOGO	GO	NOGO	GO	NOGO
M15	0.5	-15G	-15GN	-15GE	-15GEN	-15GH	-15GHN
	0.75	-15L	-15LN	-15LE	-15LEN	-15LH	-15LHN
	1	-15P	-15PN	-15PE	-15PEN	-15PH	-15PHN
	1.5	-15R	-15RN	-15RE	-15REN	-15RH	-15RHN
M16	0.5	-16G	-16GN	-16GE	-16GEN	-16GH	-16GHN
	0.75	-16L	-16LN	-16LE	-16LEN	-16LH	-16LHN
	1	-16P	-16PN	-16PE	-16PEN	-16PH	-16PHN
	1.25	-16Q	-16QN	-16QE	-16QEN	-16QH	-16QHN
	1.5	-16R	-16RN	-16RE	-16REN	-16RH	-16RHN
M17	0.5	-17G	-17GN	-17GE	-17GEN	-17GH	-17GHN
	0.75	-17L	-17LN	-17LE	-17LEN	-17LH	-17LHN
	1	-17P	-17PN	-17PE	-17PEN	-17PH	-17PHN
	1.5	-17R	-17RN	-17RE	-17REN	-17RH	-17RHN
M18	0.5	-18G	-18GN	-18GE	-18GEN	-18GH	-18GHN
	0.75	-18L	-18LN	-18LE	-18LEN	-18LH	-18LHN
	1	-18P	-18PN	-18PE	-18PEN	-18PH	-18PHN
	1.25	-18Q	-18QN	-18QE	-18QEN	-18QH	-18QHN
	1.5	-18R	-18RN	-18RE	-18REN	-18RH	-18RHN
	2	-18T	-18TN	-18TE	-18TEN	-18TH	-18THN
M19	0.5	-19G	-19GN	-19GE	-19GEN	-19GH	-19GHN
	0.75	-19L	-19LN	-19LE	-19LEN	-19LH	-19LHN
	1	-19P	-19PN	-19PE	-19PEN	-19PH	-19PHN
	1.5	-19R	-19RN	-19RE	-19REN	-19RH	-19RHN
M20	0.5	-20G	-20GN	-20GE	-20GEN	-20GH	-20GHN
	0.75	-20L	-20LN	-20LE	-20LEN	-20LH	-20LHN
	1	-20P	-20PN	-20PE	-20PEN	-20PH	-20PHN
	1.25	-20Q	-20QN	-20QE	-20QEN	-20QH	-20QHN
	1.5	-20R	-20RN	-20RE	-20REN	-20RH	-20RHN
	2	-20T	-20TN	-20TE	-20TEN	-20TH	-20THN
M21	0.75	-21L	-21LN	-21LE	-21LEN	-21LH	-21LHN
	1	-21P	-21PN	-21PE	-21PEN	-21PH	-21PHN
	1.5	-21R	-21RN	-21RE	-21REN	-21RH	-21RHN
M22	0.75	-22L	-22LN	-22LE	-22LEN	-22LH	-22LHN
	1	-22P	-22PN	-22PE	-22PEN	-22PH	-22PHN
	1.25	-22Q	-22QN	-22QE	-22QEN	-22QH	-22QHN
	1.5	-22R	-22RN	-22RE	-22REN	-22RH	-22RHN
	2	-22T	-22TN	-22TE	-22TEN	-22TH	-22THN
M23	0.75	-23L	-23LN	-23LE	-23LEN	-23LH	-23LHN
	1	-23P	-23PN	-23PE	-23PEN	-23PH	-23PHN
M24	0.75	-24L	-24LN	-24LE	-24LEN	-24LH	-24LHN
	1	-24P	-24PN	-24PE	-24PEN	-24PH	-24PHN
	1.25	-24Q	-24QN	-24QE	-24QEN	-24QH	-24QHN
	1.5	-24R	-24RN	-24RE	-24REN	-24RH	-24RHN
	2	-24T	-24TN	-24TE	-24TEN	-24TH	-24THN
M25	0.75	-25L	-25LN	-25LE	-25LEN	-25LH	-25LHN
	1	-25P	-25PN	-25PE	-25PEN	-25PH	-25PHN
	1.5	-25R	-25RN	-25RE	-25REN	-25RH	-25RHN
	2	-25T	-25TN	-25TE	-25TEN	-25TH	-25THN
M26	0.75	-26L	-26LN	-26LE	-26LEN	-26LH	-26LHN
	1	-26P	-26PN	-26PE	-26PEN	-26PH	-26PHN
	1.5	-26R	-26RN	-26RE	-26REN	-26RH	-26RHN
	2	-26T	-26TN	-26TE	-26TEN	-26TH	-26THN

To be continued



Continued from previous page

Size (mm)		Code (4129)					
Nominal diameter	Pitch	Class 6g		Class 6e		Class 6h	
		GO	NOGO	GO	NOGO	GO	NOGO
M27	0.75	-27L	-27LN	-27LE	-27LEN	-27LH	-27LHN
	1	-27P	-27PN	-27PE	-27PEN	-27PH	-27PHN
	1.5	-27R	-27RN	-27RE	-27REN	-27RH	-27RHN
	2	-27T	-27TN	-27TE	-27TEN	-27TH	-27THN
M28	0.75	-28L	-28LN	-28LE	-28LEN	-28LH	-28LHN
	1	-28P	-28PN	-28PE	-28PEN	-28PH	-28PHN
	1.5	-28R	-28RN	-28RE	-28REN	-28RH	-28RHN
	2	-28T	-28TN	-28TE	-28TEN	-28TH	-28THN
M29	0.75	-29L	-29LN	-29LE	-29LEN	-29LH	-29LHN
	1	-29P	-29PN	-29PE	-29PEN	-29PH	-29PHN
M30	0.75	-30L	-30LN	-30LE	-30LEN	-30LH	-30LHN
	1	-30P	-30PN	-30PE	-30PEN	-30PH	-30PHN
	1.5	-30R	-30RN	-30RE	-30REN	-30RH	-30RHN
	2	-30T	-30TN	-30TE	-30TEN	-30TH	-30THN
M31	3	-30V	-30VN	-30VE	-30VEN	-30VH	-30VHN
	0.75	-31L	-31LN	-31LE	-31LEN	-31LH	-31LHN
M32	0.75	-32L	-32LN	-32LE	-32LEN	-32LH	-32LHN
	1	-32P	-32PN	-32PE	-32PEN	-32PH	-32PHN
	1.5	-32R	-32RN	-32RE	-32REN	-32RH	-32RHN
	2	-32T	-32TN	-32TE	-32TEN	-32TH	-32THN
M33	0.75	-33L	-33LN	-33LE	-33LEN	-33LH	-33LHN
	1	-33P	-33PN	-33PE	-33PEN	-33PH	-33PHN
	1.5	-33R	-33RN	-33RE	-33REN	-33RH	-33RHN
	2	-33T	-33TN	-33TE	-33TEN	-33TH	-33THN
M34	3	-33V	-33VN	-33VE	-33VEN	-33VH	-33VHN
	1	-34P	-34PN	-34PE	-34PEN	-34PH	-34PHN
	1.5	-34R	-34RN	-34RE	-34REN	-34RH	-34RHN
M35	2	-34T	-34TN	-34TE	-34TEN	-34TH	-34THN
	1	-35P	-35PN	-35PE	-35PEN	-35PH	-35PHN
M36	1.5	-35R	-35RN	-35RE	-35REN	-35RH	-35RHN
	2	-35T	-35TN	-35TE	-35TEN	-35TH	-35THN
	1	-36P	-36PN	-36PE	-36PEN	-36PH	-36PHN
M38	1.5	-36R	-36RN	-36RE	-36REN	-36RH	-36RHN
	2	-36T	-36TN	-36TE	-36TEN	-36TH	-36THN
	3	-36V	-36VN	-36VE	-36VEN	-36VH	-36VHN
M39	1	-38P	-38PN	-38PE	-38PEN	-38PH	-38PHN
	1.5	-38R	-38RN	-38RE	-38REN	-38RH	-38RHN
	2	-38T	-38TN	-38TE	-38TEN	-38TH	-38THN
M40	1	-39P	-39PN	-39PE	-39PEN	-39PH	-39PHN
	1.5	-39R	-39RN	-39RE	-39REN	-39RH	-39RHN
	2	-39T	-39TN	-39TE	-39TEN	-39TH	-39THN
M42	3	-39V	-39VN	-39VE	-39VEN	-39VH	-39VHN
	1.5	-40R	-40RN	-40RE	-40REN	-40RH	-40RHN
	2	-40T	-40TN	-40TE	-40TEN	-40TH	-40THN
M45	3	-40V	-40VN	-40VE	-40VEN	-40VH	-40VHN
	1.5	-42R	-42RN	-42RE	-42REN	-42RH	-42RHN
	2	-42T	-42TN	-42TE	-42TEN	-42TH	-42THN
M45	3	-42V	-42VN	-42VE	-42VEN	-42VH	-42VHN
	1.5	-45R	-45RN	-45RE	-45REN	-45RH	-45RHN
	2	-45T	-45TN	-45TE	-45TEN	-45TH	-45THN
	3	-45V	-45VN	-45VE	-45VEN	-45VH	-45VHN

To be continued

Continued from previous page

Size (mm)		Code (4129)					
Nominal diameter	Pitch	Class 6g		Class 6e		Class 6h	
		GO	NOGO	GO	NOGO	GO	NOGO
M48	1.5	-48R	-48RN	-48RE	-48REN	-48RH	-48RHN
	2	-48T	-48TN	-48TE	-48TEN	-48TH	-48THN
	3	-48V	-48VN	-48VE	-48VEN	-48VH	-48VHN
M50	1.5	-50R	-50RN	-50RE	-50REN	-50RH	-50RHN
	2	-50T	-50TN	-50TE	-50TEN	-50TH	-50THN
	3	-50V	-50VN	-50VE	-50VEN	-50VH	-50VHN
M52	1.5	-52R	-52RN	-52RE	-52REN	-52RH	-52RHN
	2	-52T	-52TN	-52TE	-52TEN	-52TH	-52THN
	3	-52V	-52VN	-52VE	-52VEN	-52VH	-52VHN
	4	-52X	-52XN	-52XE	-52XEN	-52XH	-52XHN
M55	1.5	-55R	-55RN	-55RE	-55REN	-55RH	-55RHN
	2	-55T	-55TN	-55TE	-55TEN	-55TH	-55THN
	3	-55V	-55VN	-55VE	-55VEN	-55VH	-55VHN
	4	-55X	-55XN	-55XE	-55XEN	-55XH	-55XHN
M56	1.5	-56R	-56RN	-56RE	-56REN	-56RH	-56RHN
	2	-56T	-56TN	-56TE	-56TEN	-56TH	-56THN
	3	-56V	-56VN	-56VE	-56VEN	-56VH	-56VHN
	4	-56X	-56XN	-56XE	-56XEN	-56XH	-56XHN
M58	1.5	-58R	-58RN	-58RE	-58REN	-58RH	-58RHN
	2	-58T	-58TN	-58TE	-58TEN	-58TH	-58THN
	3	-58V	-58VN	-58VE	-58VEN	-58VH	-58VHN
	4	-58X	-58XN	-58XE	-58XEN	-58XH	-58XHN
M60	1.5	-60R	-60RN	-60RE	-60REN	-60RH	-60RHN
	2	-60T	-60TN	-60TE	-60TEN	-60TH	-60THN
	3	-60V	-60VN	-60VE	-60VEN	-60VH	-60VHN
	4	-60X	-60XN	-60XE	-60XEN	-60XH	-60XHN
M62	1.5	-62R	-62RN	-62RE	-62REN	-62RH	-62RHN
	2	-62T	-62TN	-62TE	-62TEN	-62TH	-62THN
	3	-62V	-62VN	-62VE	-62VEN	-62VH	-62VHN
	4	-62X	-62XN	-62XE	-62XEN	-62XH	-62XHN
M64	1.5	-64R	-64RN	-64RE	-64REN	-64RH	-64RHN
	2	-64T	-64TN	-64TE	-64TEN	-64TH	-64THN
	3	-64V	-64VN	-64VE	-64VEN	-64VH	-64VHN
	4	-64X	-64XN	-64XE	-64XEN	-64XH	-64XHN
M65	1.5	-65R	-65RN	-65RE	-65REN	-65RH	-65RHN
	2	-65T	-65TN	-65TE	-65TEN	-65TH	-65THN
	3	-65V	-65VN	-65VE	-65VEN	-65VH	-65VHN
	4	-65X	-65XN	-65XE	-65XEN	-65XH	-65XHN
M68	1.5	-68R	-68RN	-68RE	-68REN	-68RH	-68RHN
	2	-68T	-68TN	-68TE	-68TEN	-68TH	-68THN
	3	-68V	-68VN	-68VE	-68VEN	-68VH	-68VHN
	4	-68X	-68XN	-68XE	-68XEN	-68XH	-68XHN
M70	1.5	-70R	-70RN	-70RE	-70REN	-70RH	-70RHN
	2	-70T	-70TN	-70TE	-70TEN	-70TH	-70THN
	3	-70V	-70VN	-70VE	-70VEN	-70VH	-70VHN
	4	-70X	-70XN	-70XE	-70XEN	-70XH	-70XHN
	6	-70O	-70ON	-70OE	-70OEN	-70OH	-70OHN
M72	1.5	-72R	-72RN	-72RE	-72REN	-72RH	-72RHN
	2	-72T	-72TN	-72TE	-72TEN	-72TH	-72THN

To be continued



Continued from previous page

Size (mm)		Code (4129)						
Nominal diameter	Pitch	Class 6g		Class 6e		Class 6h		
		GO	NOGO	GO	NOGO	GO	NOGO	
M72	3	-72V	-72VN	-72VE	-72VEN	-72VH	-72VHN	
	4	-72X	-72XN	-72XE	-72XEN	-72XH	-72XHN	
	6	-72O	-72ON	-72OE	-72OEN	-72OH	-72OHN	
M75	1.5	-75R	-75RN	-75RE	-75REN	-75RH	-75RHN	
	2	-75T	-75TN	-75TE	-75TEN	-75TH	-75THN	
	3	-75V	-75VN	-75VE	-75VEN	-75VH	-75VHN	
	4	-75X	-75XN	-75XE	-75XEN	-75XH	-75XHN	
M76	1.5	-76R	-76RN	-76RE	-76REN	-76RH	-76RHN	
	2	-76T	-76TN	-76TE	-76TEN	-76TH	-76THN	
	3	-76V	-76VN	-76VE	-76VEN	-76VH	-76VHN	
	4	-76X	-76XN	-76XE	-76XEN	-76XH	-76XHN	
M78	2	-78T	-78TN	-78TE	-78TEN	-78TH	-78THN	
	M80	1.5	-80R	-80RN	-80RE	-80REN	-80RH	-80RHN
		2	-80T	-80TN	-80TE	-80TEN	-80TH	-80THN
3		-80V	-80VN	-80VE	-80VEN	-80VH	-80VHN	
4		-80X	-80XN	-80XE	-80XEN	-80XH	-80XHN	
M82	6	-80O	-80ON	-80OE	-80OEN	-80OH	-80OHN	
	2	-82T	-82TN	-82TE	-82TEN	-82TH	-82THN	
	M85	2	-85T	-85TN	-85TE	-85TEN	-85TH	-85THN
3		-85V	-85VN	-85VE	-85VEN	-85VH	-85VHN	
4		-85X	-85XN	-85XE	-85XEN	-85XH	-85XHN	
6		-85O	-85ON	-85OE	-85OEN	-85OH	-85OHN	
M90	2	-90T	-90TN	-90TE	-90TEN	-90TH	-90THN	
	3	-90V	-90VN	-90VE	-90VEN	-90VH	-90VHN	
	4	-90X	-90XN	-90XE	-90XEN	-90XH	-90XHN	
	6	-90O	-90ON	-90OE	-90OEN	-90OH	-90OHN	
M95	2	-95T	-95TN	-95TE	-95TEN	-95TH	-95THN	
	3	-95V	-95VN	-95VE	-95VEN	-95VH	-95VHN	
	4	-95X	-95XN	-95XE	-95XEN	-95XH	-95XHN	
	6	-95O	-95ON	-95OE	-95OEN	-95OH	-95OHN	
M100	2	-100T	-100TN	-100TE	-100TEN	-100TH	-100THN	
	3	-100V	-100VN	-100VE	-100VEN	-100VH	-100VHN	
	4	-100X	-100XN	-100XE	-100XEN	-100XH	-100XHN	
	6	-100O	-100ON	-100OE	-100OEN	-100OH	-100OHN	
M105	2	-105T	-105TN	-105TE	-105TEN	-105TH	-105THN	
	3	-105V	-105VN	-105VE	-105VEN	-105VH	-105VHN	
	4	-105X	-105XN	-105XE	-105XEN	-105XH	-105XHN	
	6	-105O	-105ON	-105OE	-105OEN	-105OH	-105OHN	
M110	2	-110T	-110TN	-110TE	-110TEN	-110TH	-110THN	
	3	-110V	-110VN	-110VE	-110VEN	-110VH	-110VHN	
	4	-110X	-110XN	-110XE	-110XEN	-110XH	-110XHN	
	6	-110O	-110ON	-110OE	-110OEN	-110OH	-110OHN	
M115	2	-115T	-115TN	-115TE	-115TEN	-115TH	-115THN	
	3	-115V	-115VN	-115VE	-115VEN	-115VH	-115VHN	
	4	-115X	-115XN	-115XE	-115XEN	-115XH	-115XHN	
	6	-115O	-115ON	-115OE	-115OEN	-115OH	-115OHN	
M120	2	-120T	-120TN	-120TE	-120TEN	-120TH	-120THN	
	3	-120V	-120VN	-120VE	-120VEN	-120VH	-120VHN	
	4	-120X	-120XN	-120XE	-120XEN	-120XH	-120XHN	
	6	-120O	-120ON	-120OE	-120OEN	-120OH	-120OHN	

AMERICAN STANDARD THREAD PLUG GAUGES

WARNING: LIFE TIME IS LIMITED,
CAN BE USED ABOUT 2000 TIMES

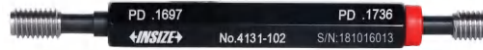

4131-102

- Supplied with Go and No-Go gauges together
- Standard ANSI/ASME B1.2
- Supplied with manufacturer inspection certificate

Size	Code	
	Class 2B	Class 3B
No. 0-80UNF	4131-02	4131-02B
No. 1-64UNC	4131-11	4131-11B
No. 1-72UNF	4131-12	4131-12B
No. 2-56UNC	4131-21	4131-21B
No. 2-64UNF	4131-22	4131-22B
No. 3-48UNC	4131-31	4131-31B
No. 3-56UNF	4131-32	4131-32B
No. 4-40UNC	4131-41	4131-41B
No. 4-48UNF	4131-42	4131-42B
No. 5-40UNC	4131-51	4131-51B
No. 5-44UNF	4131-52	4131-52B
No. 6-32UNC	4131-61	4131-61B
No. 6-40UNF	4131-62	4131-62B
No. 8-32UNC	4131-81	4131-81B
No. 8-36UNF	4131-82	4131-82B
No. 10-24UNC	4131-101	4131-101B
No. 10-32UNF	4131-102	4131-102B
No. 12-24UNC	4131-121	4131-121B
No. 12-28UNF	4131-122	4131-122B
No. 12-32UNEF	4131-123	4131-123B
1/4-20UNC	4131-1B1	4131-1B1B
1/4-28UNF	4131-1B2	4131-1B2B
1/4-32UNEF	4131-1B3	4131-1B3B
1/4-36UNS	4131-1B4	4131-1B4B
5/16-18UNC	4131-5D1	4131-5D1B
5/16-24UNF	4131-5D2	4131-5D2B
5/16-32UNEF	4131-5D3	4131-5D3B
3/8-16UNC	4131-3C1	4131-3C1B
3/8-24UNF	4131-3C2	4131-3C2B
3/8-32UNEF	4131-3C3	4131-3C3B
7/16-14UNC	4131-7D1	4131-7D1B
7/16-20UNF	4131-7D2	4131-7D2B
7/16-28UNEF	4131-7D3	4131-7D3B
1/2-13UNC	4131-1A1	4131-1A1B
1/2-20UNF	4131-1A2	4131-1A2B
1/2-28UNEF	4131-1A3	4131-1A3B

Size	Code	
	Class 2B	Class 3B
9/16-12UNC	4131-9D1	4131-9D1B
9/16-18UNF	4131-9D2	4131-9D2B
9/16-24UNEF	4131-9D3	4131-9D3B
5/8-11UNC	4131-5C1	4131-5C1B
5/8-18UNF	4131-5C2	4131-5C2B
5/8-24UNEF	4131-5C3	4131-5C3B
11/16-16UN	4131-11D516	4131-11D516B
11/16-24UNEF	4131-11D3	4131-11D3B
3/4-10UNC	4131-3B1	4131-3B1B
3/4-16UNF	4131-3B2	4131-3B2B
3/4-20UNEF	4131-3B3	4131-3B3B
13/16-16UN	4131-13D516	4131-13D516B
13/16-20UNEF	4131-13D3	4131-13D3B
7/8-9UNC	4131-7C1	4131-7C1B
7/8-14UNF	4131-7C2	4131-7C2B
7/8-16UN	4131-7C516	4131-7C516B
7/8-20UNEF	4131-7C3	4131-7C3B
15/16-20UNEF	4131-15D3	4131-15D3B
1-8UNC	4131-2A1	4131-2A1B
1-12UNF	4131-2A2	4131-2A2B
1-14UNS	4131-2A514	4131-2A514B
1-20UNEF	4131-2A3	4131-2A3B
1-32UN	4131-2A532	4131-2A532B
1 1/16-12UN	4131-1E512	4131-1E512B
1 1/16-18UNEF	4131-1E3	4131-1E3B
1 1/8-7UNC	4131-1F1	4131-1F1B
1 1/8-8UN	4131-1F58	4131-1F58B
1 1/8-12UNF	4131-1F2	4131-1F2B
1 1/8-18UNEF	4131-1F3	4131-1F3B
1 3/16-12UN	4131-3E512	4131-3E512B
1 3/16-18UNEF	4131-3E3	4131-3E3B
1 1/4-7UNC	4131-1G1	4131-1G1B
1 1/4-8UN	4131-1G58	4131-1G58B
1 1/4-12UNF	4131-1G2	4131-1G2B
1 1/4-18UNEF	4131-1G3	4131-1G3B
1 5/16-12UN	4131-5E512	4131-5E512B



WARNING: LIFE TIME IS LIMITED,
CAN BE USED ABOUT 2000 TIMES

AMERICAN STANDARD THREAD RING GAUGES



- Standard ANSI/ASME B1.2
- Class 2A
- Supplied with manufacturer inspection certificate

Size	Code	
	GO	NOGO
No. 4-40UNC	4121-41	4121-41N
No. 4-48UNF	4121-42	4121-42N
No. 5-40UNC	4121-51	4121-51N
No. 5-44UNF	4121-52	4121-52N
No. 6-32UNC	4121-61	4121-61N
No. 6-40UNF	4121-62	4121-62N
No. 8-32UNC	4121-81	4121-81N
No. 8-36UNF	4121-82	4121-82N
No. 10-24UNC	4121-101	4121-101N
No. 10-32UNF	4121-102	4121-102N
No. 12-24UNC	4121-121	4121-121N
No. 12-28UNF	4121-122	4121-122N
No. 12-32UNEF	4121-123	4121-123N
1/4-20UNC	4121-1B1	4121-1B1N
1/4-28UNF	4121-1B2	4121-1B2N
1/4-32UNEF	4121-1B3	4121-1B3N
1/4-36UNS	4121-1B4	4121-1B4N
5/16-18UNC	4121-5D1	4121-5D1N
5/16-24UNF	4121-5D2	4121-5D2N
5/16-32UNEF	4121-5D3	4121-5D3N
3/8-16UNC	4121-3C1	4121-3C1N
3/8-24UNF	4121-3C2	4121-3C2N
3/8-32UNEF	4121-3C3	4121-3C3N
7/16-14UNC	4121-7D1	4121-7D1N
7/16-20UNF	4121-7D2	4121-7D2N
7/16-28UNEF	4121-7D3	4121-7D3N
1/2-13UNC	4121-1A1	4121-1A1N
1/2-20UNF	4121-1A2	4121-1A2N
1/2-28UNEF	4121-1A3	4121-1A3N
9/16-12UNC	4121-9D1	4121-9D1N
9/16-18UNF	4121-9D2	4121-9D2N
9/16-24UNEF	4121-9D3	4121-9D3N

Size	Code	
	GO	NOGO
5/8-11UNC	4121-5C1	4121-5C1N
5/8-18UNF	4121-5C2	4121-5C2N
5/8-24UNEF	4121-5C3	4121-5C3N
11/16-16UN	4121-11D516	4121-11D516N
11/16-24UNEF	4121-11D3	4121-11D3N
3/4-10UNC	4121-3B1	4121-3B1N
3/4-16UNF	4121-3B2	4121-3B2N
3/4-20UNEF	4121-3B3	4121-3B3N
13/16-16UN	4121-13D516	4121-13D516N
13/16-20UNEF	4121-13D3	4121-13D3N
7/8-9UNC	4121-7C1	4121-7C1N
7/8-14UNF	4121-7C2	4121-7C2N
7/8-16UN	4121-7C516	4121-7C516N
7/8-20UNEF	4121-7C3	4121-7C3N
15/16-20UNEF	4121-15D3	4121-15D3N
1-8UNC	4121-2A1	4121-2A1N
1-12UNF	4121-2A2	4121-2A2N
1-14UNS	4121-2A514	4121-2A514N
1-20UNEF	4121-2A3	4121-2A3N
1-32UN	4121-2A532	4121-2A532N
1 1/16-12UN	4121-1E512	4121-1E512N
1 1/16-18UNEF	4121-1E3	4121-1E3N
1 1/8-7UNC	4121-1F1	4121-1F1N
1 1/8-8UN	4121-1F58	4121-1F58N
1 1/8-12UNF	4121-1F2	4121-1F2N
1 1/8-18UNEF	4121-1F3	4121-1F3N
1 3/16-12UN	4121-3E512	4121-3E512N
1 3/16-18UNEF	4121-3E3	4121-3E3N
1 1/4-7UNC	4121-1G1	4121-1G1N
1 1/4-8UN	4121-1G58	4121-1G58N
1 1/4-12UNF	4121-1G2	4121-1G2N
1 1/4-18UNEF	4121-1G3	4121-1G3N
1 5/16-12UN	4121-5E512	4121-5E512N

CHECK PLUGS FOR METRIC THREAD RING GAUGES



4647-10

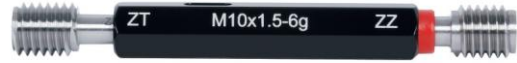

4647-10N

- Standard ISO1502
- Check thread ring gauges
- Supplied with manufacturer inspection certificate

Code example:
"-2" stands for "4647-2"

Size (mm)		Code (4647)					
Nominal diameter	Pitch	Class 6g		Class 6e		Class 6h	
		GO	NOGO	GO	NOGO	GO	NOGO
M2	0.4	-2	-2N	-2E	-2EN	-2H	-2HN
M2.2	0.45	-2D2	-2D2N	-2D2E	-2D2EN	-2D2H	-2D2HN
M2.3	0.4	-2D3	-2D3N	-2D3E	-2D3EN	-2D3H	-2D3HN
M2.5	0.45	-2D5	-2D5N	-2D5E	-2D5EN	-2D5H	-2D5HN
M2.6	0.45	-2D6	-2D6N	-2D6E	-2D6EN	-2D6H	-2D6HN
M3	0.5	-3	-3N	-3E	-3EN	-3H	-3HN
M3.5	0.6	-3D5	-3D5N	-3D5E	-3D5EN	-3D5H	-3D5HN
M4	0.7	-4	-4N	-4E	-4EN	-4H	-4HN
M4.5	0.75	-4D5	-4D5N	-4D5E	-4D5EN	-4D5H	-4D5HN
M5	0.8	-5	-5N	-5E	-5EN	-5H	-5HN
M6	1	-6	-6N	-6E	-6EN	-6H	-6HN
M7	1	-7	-7N	-7E	-7EN	-7H	-7HN
M8	1.25	-8	-8N	-8E	-8EN	-8H	-8HN
M9	1.25	-9	-9N	-9E	-9EN	-9H	-9HN
M10	1.5	-10	-10N	-10E	-10EN	-10H	-10HN
M11	1.5	-11	-11N	-11E	-11EN	-11H	-11HN
M12	1.75	-12	-12N	-12E	-12EN	-12H	-12HN
M14	2	-14	-14N	-14E	-14EN	-14H	-14HN
M16	2	-16	-16N	-16E	-16EN	-16H	-16HN
M18	2.5	-18	-18N	-18E	-18EN	-18H	-18HN
M20	2.5	-20	-20N	-20E	-20EN	-20H	-20HN
M22	2.5	-22	-22N	-22E	-22EN	-22H	-22HN
M24	3	-24	-24N	-24E	-24EN	-24H	-24HN
M27	3	-27	-27N	-27E	-27EN	-27H	-27HN
M30	3.5	-30	-30N	-30E	-30EN	-30H	-30HN
M33	3.5	-33	-33N	-33E	-33EN	-33H	-33HN
M36	4	-36	-36N	-36E	-36EN	-36H	-36HN
M39	4	-39	-39N	-39E	-39EN	-39H	-39HN
M42	4.5	-42	-42N	-42E	-42EN	-42H	-42HN
M45	4.5	-45	-45N	-45E	-45EN	-45H	-45HN
M48	5	-48	-48N	-48E	-48EN	-48H	-48HN
M52	5	-52	-52N	-52E	-52EN	-52H	-52HN
M56	5.5	-56	-56N	-56E	-56EN	-56H	-56HN
M60	5.5	-60	-60N	-60E	-60EN	-60H	-60HN
M64	6	-64	-64N	-64E	-64EN	-64H	-64HN
M68	6	-68	-68N	-68E	-68EN	-68H	-68HN

CHECK PLUGS FOR METRIC FINE THREAD RING GAUGES



4677-10P

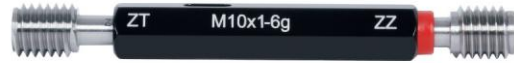

4677-10PN

- Standard ISO1502
- Check thread ring gauges
- Supplied with manufacturer inspection certificate

Code example:
 “-3D5G” stands for “4677-3D5G”

Size (mm)		Code (4677)					
		Class 6g		Class 6e		Class 6h	
Nominal diameter	Pitch	GO	NOGO	GO	NOGO	GO	NOGO
M3.5	0.5	-3D5G	-3D5GN	-3D5GE	-3D5GEN	-3D5GH	-3D5GHN
M4	0.5	-4G	-4GN	-4GE	-4GEN	-4GH	-4GHN
M4.5	0.5	-4D5G	-4D5GN	-4D5GE	-4D5GEN	-4D5GH	-4D5GHN
M5	0.5	-5G	-5GN	-5GE	-5GEN	-5GH	-5GHN
M5.5	0.5	-5D5G	-5D5GN	-5D5GE	-5D5GEN	-5D5GH	-5D5GHN
M6	0.5	-6G	-6GN	-6GE	-6GEN	-6GH	-6GHN
	0.75	-6L	-6LN	-6LE	-6LEN	-6LH	-6LHN
M6.5	0.5	-6D5G	-6D5GN	-6D5GE	-6D5GEN	-6D5GH	-6D5GHN
M7	0.5	-7G	-7GN	-7GE	-7GEN	-7GH	-7GHN
	0.75	-7L	-7LN	-7LE	-7LEN	-7LH	-7LHN
M7.5	0.5	-7D5G	-7D5GN	-7D5GE	-7D5GEN	-7D5GH	-7D5GHN
M8	0.5	-8G	-8GN	-8GE	-8GEN	-8GH	-8GHN
	0.75	-8L	-8LN	-8LE	-8LEN	-8LH	-8LHN
	1	-8P	-8PN	-8PE	-8PEN	-8PH	-8PHN
M8.5	0.5	-8D5G	-8D5GN	-8D5GE	-8D5GEN	-8D5GH	-8D5GHN
M9	0.5	-9G	-9GN	-9GE	-9GEN	-9GH	-9GHN
	0.75	-9L	-9LN	-9LE	-9LEN	-9LH	-9LHN
	1	-9P	-9PN	-9PE	-9PEN	-9PH	-9PHN
M10	0.5	-10G	-10GN	-10GE	-10GEN	-10GH	-10GHN
	0.75	-10L	-10LN	-10LE	-10LEN	-10LH	-10LHN
	1	-10P	-10PN	-10PE	-10PEN	-10PH	-10PHN
	1.25	-10Q	-10QN	-10QE	-10QEN	-10QH	-10QHN
M11	0.5	-11G	-11GN	-11GE	-11GEN	-11GH	-11GHN
	0.75	-11L	-11LN	-11LE	-11LEN	-11LH	-11LHN
	1	-11P	-11PN	-11PE	-11PEN	-11PH	-11PHN
M12	0.5	-12G	-12GN	-12GE	-12GEN	-12GH	-12GHN
	0.75	-12L	-12LN	-12LE	-12LEN	-12LH	-12LHN
	1	-12P	-12PN	-12PE	-12PEN	-12PH	-12PHN
	1.25	-12Q	-12QN	-12QE	-12QEN	-12QH	-12QHN
	1.5	-12R	-12RN	-12RE	-12REN	-12RH	-12RHN
M13	0.5	-13G	-13GN	-13GE	-13GEN	-13GH	-13GHN
	0.75	-13L	-13LN	-13LE	-13LEN	-13LH	-13LHN
	1	-13P	-13PN	-13PE	-13PEN	-13PH	-13PHN
	1.5	-13R	-13RN	-13RE	-13REN	-13RH	-13RHN
M14	0.5	-14G	-14GN	-14GE	-14GEN	-14GH	-14GHN
	0.75	-14L	-14LN	-14LE	-14LEN	-14LH	-14LHN
	1	-14P	-14PN	-14PE	-14PEN	-14PH	-14PHN
	1.25	-14Q	-14QN	-14QE	-14QEN	-14QH	-14QHN
	1.5	-14R	-14RN	-14RE	-14REN	-14RH	-14RHN

To be continued

Continued from previous page

Size (mm)		Code (4677)					
Nominal diameter	Pitch	Class 6g		Class 6e		Class 6h	
		GO	NOGO	GO	NOGO	GO	NOGO
M15	0.5	-15G	-15GN	-15GE	-15GEN	-15GH	-15GHN
	0.75	-15L	-15LN	-15LE	-15LEN	-15LH	-15LHN
	1	-15P	-15PN	-15PE	-15PEN	-15PH	-15PHN
	1.5	-15R	-15RN	-15RE	-15REN	-15RH	-15RHN
M16	0.5	-16G	-16GN	-16GE	-16GEN	-16GH	-16GHN
	0.75	-16L	-16LN	-16LE	-16LEN	-16LH	-16LHN
	1	-16P	-16PN	-16PE	-16PEN	-16PH	-16PHN
	1.25	-16Q	-16QN	-16QE	-16QEN	-16QH	-16QHN
	1.5	-16R	-16RN	-16RE	-16REN	-16RH	-16RHN
M17	0.5	-17G	-17GN	-17GE	-17GEN	-17GH	-17GHN
	0.75	-17L	-17LN	-17LE	-17LEN	-17LH	-17LHN
	1	-17P	-17PN	-17PE	-17PEN	-17PH	-17PHN
	1.5	-17R	-17RN	-17RE	-17REN	-17RH	-17RHN
M18	0.5	-18G	-18GN	-18GE	-18GEN	-18GH	-18GHN
	0.75	-18L	-18LN	-18LE	-18LEN	-18LH	-18LHN
	1	-18P	-18PN	-18PE	-18PEN	-18PH	-18PHN
	1.25	-18Q	-18QN	-18QE	-18QEN	-18QH	-18QHN
	1.5	-18R	-18RN	-18RE	-18REN	-18RH	-18RHN
	2	-18T	-18TN	-18TE	-18TEN	-18TH	-18THN
M19	0.5	-19G	-19GN	-19GE	-19GEN	-19GH	-19GHN
	0.75	-19L	-19LN	-19LE	-19LEN	-19LH	-19LHN
	1	-19P	-19PN	-19PE	-19PEN	-19PH	-19PHN
	1.5	-19R	-19RN	-19RE	-19REN	-19RH	-19RHN
M20	0.5	-20G	-20GN	-20GE	-20GEN	-20GH	-20GHN
	0.75	-20L	-20LN	-20LE	-20LEN	-20LH	-20LHN
	1	-20P	-20PN	-20PE	-20PEN	-20PH	-20PHN
	1.25	-20Q	-20QN	-20QE	-20QEN	-20QH	-20QHN
	1.5	-20R	-20RN	-20RE	-20REN	-20RH	-20RHN
	2	-20T	-20TN	-20TE	-20TEN	-20TH	-20THN
M21	0.75	-21L	-21LN	-21LE	-21LEN	-21LH	-21LHN
	1	-21P	-21PN	-21PE	-21PEN	-21PH	-21PHN
	1.5	-21R	-21RN	-21RE	-21REN	-21RH	-21RHN
M22	0.75	-22L	-22LN	-22LE	-22LEN	-22LH	-22LHN
	1	-22P	-22PN	-22PE	-22PEN	-22PH	-22PHN
	1.25	-22Q	-22QN	-22QE	-22QEN	-22QH	-22QHN
	1.5	-22R	-22RN	-22RE	-22REN	-22RH	-22RHN
	2	-22T	-22TN	-22TE	-22TEN	-22TH	-22THN
M23	0.75	-23L	-23LN	-23LE	-23LEN	-23LH	-23LHN
	1	-23P	-23PN	-23PE	-23PEN	-23PH	-23PHN
M24	0.75	-24L	-24LN	-24LE	-24LEN	-24LH	-24LHN
	1	-24P	-24PN	-24PE	-24PEN	-24PH	-24PHN
	1.25	-24Q	-24QN	-24QE	-24QEN	-24QH	-24QHN
	1.5	-24R	-24RN	-24RE	-24REN	-24RH	-24RHN
	2	-24T	-24TN	-24TE	-24TEN	-24TH	-24THN
M25	0.75	-25L	-25LN	-25LE	-25LEN	-25LH	-25LHN
	1	-25P	-25PN	-25PE	-25PEN	-25PH	-25PHN
	1.5	-25R	-25RN	-25RE	-25REN	-25RH	-25RHN
	2	-25T	-25TN	-25TE	-25TEN	-25TH	-25THN
M26	0.75	-26L	-26LN	-26LE	-26LEN	-26LH	-26LHN
	1	-26P	-26PN	-26PE	-26PEN	-26PH	-26PHN
	1.5	-26R	-26RN	-26RE	-26REN	-26RH	-26RHN
	2	-26T	-26TN	-26TE	-26TEN	-26TH	-26THN

To be continued



Continued from previous page

Size (mm)		Code (4677)					
Nominal diameter	Pitch	Class 6g		Class 6e		Class 6h	
		GO	NOGO	GO	NOGO	GO	NOGO
M27	0.75	-27L	-27LN	-27LE	-27LEN	-27LH	-27LHN
	1	-27P	-27PN	-27PE	-27PEN	-27PH	-27PHN
	1.5	-27R	-27RN	-27RE	-27REN	-27RH	-27RHN
	2	-27T	-27TN	-27TE	-27TEN	-27TH	-27THN
M28	0.75	-28L	-28LN	-28LE	-28LEN	-28LH	-28LHN
	1	-28P	-28PN	-28PE	-28PEN	-28PH	-28PHN
	1.5	-28R	-28RN	-28RE	-28REN	-28RH	-28RHN
M29	0.75	-29L	-29LN	-29LE	-29LEN	-29LH	-29LHN
	1	-29P	-29PN	-29PE	-29PEN	-29PH	-29PHN
M30	0.75	-30L	-30LN	-30LE	-30LEN	-30LH	-30LHN
	1	-30P	-30PN	-30PE	-30PEN	-30PH	-30PHN
	1.5	-30R	-30RN	-30RE	-30REN	-30RH	-30RHN
	2	-30T	-30TN	-30TE	-30TEN	-30TH	-30THN
M31	3	-30V	-30VN	-30VE	-30VEN	-30VH	-30VHN
	0.75	-31L	-31LN	-31LE	-31LEN	-31LH	-31LHN
M32	0.75	-32L	-32LN	-32LE	-32LEN	-32LH	-32LHN
	1	-32P	-32PN	-32PE	-32PEN	-32PH	-32PHN
	1.5	-32R	-32RN	-32RE	-32REN	-32RH	-32RHN
M33	2	-32T	-32TN	-32TE	-32TEN	-32TH	-32THN
	0.75	-33L	-33LN	-33LE	-33LEN	-33LH	-33LHN
	1	-33P	-33PN	-33PE	-33PEN	-33PH	-33PHN
M34	1.5	-33R	-33RN	-33RE	-33REN	-33RH	-33RHN
	2	-33T	-33TN	-33TE	-33TEN	-33TH	-33THN
	3	-33V	-33VN	-33VE	-33VEN	-33VH	-33VHN
M35	1	-34P	-34PN	-34PE	-34PEN	-34PH	-34PHN
	1.5	-34R	-34RN	-34RE	-34REN	-34RH	-34RHN
	2	-34T	-34TN	-34TE	-34TEN	-34TH	-34THN
M36	1	-35P	-35PN	-35PE	-35PEN	-35PH	-35PHN
	1.5	-35R	-35RN	-35RE	-35REN	-35RH	-35RHN
	2	-35T	-35TN	-35TE	-35TEN	-35TH	-35THN
M38	1	-36P	-36PN	-36PE	-36PEN	-36PH	-36PHN
	1.5	-36R	-36RN	-36RE	-36REN	-36RH	-36RHN
	2	-36T	-36TN	-36TE	-36TEN	-36TH	-36THN
	3	-36V	-36VN	-36VE	-36VEN	-36VH	-36VHN
M39	1	-38P	-38PN	-38PE	-38PEN	-38PH	-38PHN
	1.5	-38R	-38RN	-38RE	-38REN	-38RH	-38RHN
	2	-38T	-38TN	-38TE	-38TEN	-38TH	-38THN
M40	1	-39P	-39PN	-39PE	-39PEN	-39PH	-39PHN
	1.5	-39R	-39RN	-39RE	-39REN	-39RH	-39RHN
	2	-39T	-39TN	-39TE	-39TEN	-39TH	-39THN
M42	3	-39V	-39VN	-39VE	-39VEN	-39VH	-39VHN
	1.5	-40R	-40RN	-40RE	-40REN	-40RH	-40RHN
	2	-40T	-40TN	-40TE	-40TEN	-40TH	-40THN
M45	3	-40V	-40VN	-40VE	-40VEN	-40VH	-40VHN
	1.5	-42R	-42RN	-42RE	-42REN	-42RH	-42RHN
	2	-42T	-42TN	-42TE	-42TEN	-42TH	-42THN
M45	3	-42V	-42VN	-42VE	-42VEN	-42VH	-42VHN
	1.5	-45R	-45RN	-45RE	-45REN	-45RH	-45RHN
	2	-45T	-45TN	-45TE	-45TEN	-45TH	-45THN
	3	-45V	-45VN	-45VE	-45VEN	-45VH	-45VHN

To be continued

Continued from previous page

Size (mm)		Code (4677)					
Nominal diameter	Pitch	Class 6g		Class 6e		Class 6h	
		GO	NOGO	GO	NOGO	GO	NOGO
M48	1.5	-48R	-48RN	-48RE	-48REN	-48RH	-48RHN
	2	-48T	-48TN	-48TE	-48TEN	-48TH	-48THN
	3	-48V	-48VN	-48VE	-48VEN	-48VH	-48VHN
M50	1.5	-50R	-50RN	-50RE	-50REN	-50RH	-50RHN
	2	-50T	-50TN	-50TE	-50TEN	-50TH	-50THN
	3	-50V	-50VN	-50VE	-50VEN	-50VH	-50VHN
M52	1.5	-52R	-52RN	-52RE	-52REN	-52RH	-52RHN
	2	-52T	-52TN	-52TE	-52TEN	-52TH	-52THN
	3	-52V	-52VN	-52VE	-52VEN	-52VH	-52VHN
	4	-52X	-52XN	-52XE	-52XEN	-52XH	-52XHN
M55	1.5	-55R	-55RN	-55RE	-55REN	-55RH	-55RHN
	2	-55T	-55TN	-55TE	-55TEN	-55TH	-55THN
	3	-55V	-55VN	-55VE	-55VEN	-55VH	-55VHN
	4	-55X	-55XN	-55XE	-55XEN	-55XH	-55XHN
M56	1.5	-56R	-56RN	-56RE	-56REN	-56RH	-56RHN
	2	-56T	-56TN	-56TE	-56TEN	-56TH	-56THN
	3	-56V	-56VN	-56VE	-56VEN	-56VH	-56VHN
	4	-56X	-56XN	-56XE	-56XEN	-56XH	-56XHN
M58	1.5	-58R	-58RN	-58RE	-58REN	-58RH	-58RHN
	2	-58T	-58TN	-58TE	-58TEN	-58TH	-58THN
	3	-58V	-58VN	-58VE	-58VEN	-58VH	-58VHN
	4	-58X	-58XN	-58XE	-58XEN	-58XH	-58XHN
M60	1.5	-60R	-60RN	-60RE	-60REN	-60RH	-60RHN
	2	-60T	-60TN	-60TE	-60TEN	-60TH	-60THN
	3	-60V	-60VN	-60VE	-60VEN	-60VH	-60VHN
	4	-60X	-60XN	-60XE	-60XEN	-60XH	-60XHN
M62	1.5	-62R	-62RN	-62RE	-62REN	-62RH	-62RHN
	2	-62T	-62TN	-62TE	-62TEN	-62TH	-62THN
	3	-62V	-62VN	-62VE	-62VEN	-62VH	-62VHN
	4	-62X	-62XN	-62XE	-62XEN	-62XH	-62XHN
M64	1.5	-64R	-64RN	-64RE	-64REN	-64RH	-64RHN
	2	-64T	-64TN	-64TE	-64TEN	-64TH	-64THN
	3	-64V	-64VN	-64VE	-64VEN	-64VH	-64VHN
	4	-64X	-64XN	-64XE	-64XEN	-64XH	-64XHN
M65	1.5	-65R	-65RN	-65RE	-65REN	-65RH	-65RHN
	2	-65T	-65TN	-65TE	-65TEN	-65TH	-65THN
	3	-65V	-65VN	-65VE	-65VEN	-65VH	-65VHN
	4	-65X	-65XN	-65XE	-65XEN	-65XH	-65XHN
M68	1.5	-68R	-68RN	-68RE	-68REN	-68RH	-68RHN
	2	-68T	-68TN	-68TE	-68TEN	-68TH	-68THN
	3	-68V	-68VN	-68VE	-68VEN	-68VH	-68VHN
	4	-68X	-68XN	-68XE	-68XEN	-68XH	-68XHN
M70	1.5	-70R	-70RN	-70RE	-70REN	-70RH	-70RHN
	2	-70T	-70TN	-70TE	-70TEN	-70TH	-70THN
	3	-70V	-70VN	-70VE	-70VEN	-70VH	-70VHN
	4	-70X	-70XN	-70XE	-70XEN	-70XH	-70XHN
	6	-70O	-70ON	-70OE	-70OEN	-70OH	-70OHN
M72	1.5	-72R	-72RN	-72RE	-72REN	-72RH	-72RHN
	2	-72T	-72TN	-72TE	-72TEN	-72TH	-72THN
	3	-72V	-72VN	-72VE	-72VEN	-72VH	-72VHN

To be continued



Continued from previous page

Size (mm)		Code (4677)					
Nominal diameter	Pitch	Class 6g		Class 6e		Class 6h	
		GO	NOGO	GO	NOGO	GO	NOGO
M72	4	-72X	-72XN	-72XE	-72XEN	-72XH	-72XHN
	6	-72O	-72ON	-72OE	-72OEN	-72OH	-72OHN
M75	1.5	-75R	-75RN	-75RE	-75REN	-75RH	-75RHN
	2	-75T	-75TN	-75TE	-75TEN	-75TH	-75THN
	3	-75V	-75VN	-75VE	-75VEN	-75VH	-75VHN
	4	-75X	-75XN	-75XE	-75XEN	-75XH	-75XHN
M76	1.5	-76R	-76RN	-76RE	-76REN	-76RH	-76RHN
	2	-76T	-76TN	-76TE	-76TEN	-76TH	-76THN
	3	-76V	-76VN	-76VE	-76VEN	-76VH	-76VHN
	4	-76X	-76XN	-76XE	-76XEN	-76XH	-76XHN
M78	6	-76O	-76ON	-76OE	-76OEN	-76OH	-76OHN
	2	-78T	-78TN	-78TE	-78TEN	-78TH	-78THN
M80	1.5	-80R	-80RN	-80RE	-80REN	-80RH	-80RHN
	2	-80T	-80TN	-80TE	-80TEN	-80TH	-80THN
	3	-80V	-80VN	-80VE	-80VEN	-80VH	-80VHN
	4	-80X	-80XN	-80XE	-80XEN	-80XH	-80XHN
M82	6	-80O	-80ON	-80OE	-80OEN	-80OH	-80OHN
	2	-82T	-82TN	-82TE	-82TEN	-82TH	-82THN
M85	2	-85T	-85TN	-85TE	-85TEN	-85TH	-85THN
	3	-85V	-85VN	-85VE	-85VEN	-85VH	-85VHN
	4	-85X	-85XN	-85XE	-85XEN	-85XH	-85XHN
	6	-85O	-85ON	-85OE	-85OEN	-85OH	-85OHN
M90	2	-90T	-90TN	-90TE	-90TEN	-90TH	-90THN
	3	-90V	-90VN	-90VE	-90VEN	-90VH	-90VHN
	4	-90X	-90XN	-90XE	-90XEN	-90XH	-90XHN
	6	-90O	-90ON	-90OE	-90OEN	-90OH	-90OHN
M95	2	-95T	-95TN	-95TE	-95TEN	-95TH	-95THN
	3	-95V	-95VN	-95VE	-95VEN	-95VH	-95VHN
	4	-95X	-95XN	-95XE	-95XEN	-95XH	-95XHN
	6	-95O	-95ON	-95OE	-95OEN	-95OH	-95OHN
M100	2	-100T	-100TN	-100TE	-100TEN	-100TH	-100THN
	3	-100V	-100VN	-100VE	-100VEN	-100VH	-100VHN
	4	-100X	-100XN	-100XE	-100XEN	-100XH	-100XHN
	6	-100O	-100ON	-100OE	-100OEN	-100OH	-100OHN
M105	2	-105T	-105TN	-105TE	-105TEN	-105TH	-105THN
	3	-105V	-105VN	-105VE	-105VEN	-105VH	-105VHN
	4	-105X	-105XN	-105XE	-105XEN	-105XH	-105XHN
	6	-105O	-105ON	-105OE	-105OEN	-105OH	-105OHN
M110	2	-110T	-110TN	-110TE	-110TEN	-110TH	-110THN
	3	-110V	-110VN	-110VE	-110VEN	-110VH	-110VHN
	4	-110X	-110XN	-110XE	-110XEN	-110XH	-110XHN
	6	-110O	-110ON	-110OE	-110OEN	-110OH	-110OHN
M115	2	-115T	-115TN	-115TE	-115TEN	-115TH	-115THN
	3	-115V	-115VN	-115VE	-115VEN	-115VH	-115VHN
	4	-115X	-115XN	-115XE	-115XEN	-115XH	-115XHN
	6	-115O	-115ON	-115OE	-115OEN	-115OH	-115OHN
M120	2	-120T	-120TN	-120TE	-120TEN	-120TH	-120THN
	3	-120V	-120VN	-120VE	-120VEN	-120VH	-120VHN
	4	-120X	-120XN	-120XE	-120XEN	-120XH	-120XHN
	6	-120O	-120ON	-120OE	-120OEN	-120OH	-120OHN

THREAD GAUGES FOR ROTARY SHOULDERED CONNECTIONS OF PETROLEUM EQUIPMENT

API PRODUCTION LICENSE



- Measure the thread of rotary shouldered connections

4177-23

Number style gauges

Code	Gauge code	Form of thread to be inspected	Number of thread per inch	Taper	Angle of thread	Basic pitch dia
4177-10	NC10	V-0.055	6	1:8	60°	27.000mm
4177-12	NC12	V-0.055	6	1:8	60°	32.121mm
4177-13	NC13	V-0.055	6	1:8	60°	35.331mm
4177-16	NC16	V-0.055	6	1:8	60°	40.869mm
4177-23	NC23	V-0.038R	4	1:6	60°	59.817mm
4177-26	NC26	V-0.038R	4	1:6	60°	67.767mm
4177-31	NC31	V-0.038R	4	1:6	60°	80.848mm
4177-35	NC35	V-0.038R	4	1:6	60°	89.687mm
4177-38	NC38	V-0.038R	4	1:6	60°	96.723mm
4177-40	NC40	V-0.038R	4	1:6	60°	103.429mm
4177-44	NC44	V-0.038R	4	1:6	60°	112.192mm
4177-46	NC46	V-0.038R	4	1:6	60°	117.500mm
4177-50	NC50	V-0.038R	4	1:6	60°	128.059mm
4177-56	NC56	V-0.038R	4	1:4	60°	142.646mm
4177-61	NC61	V-0.038R	4	1:4	60°	156.921mm
4177-70	NC70	V-0.038R	4	1:4	60°	179.146mm
4177-77	NC77	V-0.038R	4	1:4	60°	196.621mm

Regular style gauges

Code	Gauge code	Form of thread to be inspected	Number of thread per inch	Taper	Angle of thread	Basic pitch dia
4177-2R	2 3/8 REG	V-0.040	5	1:4	60°	60.080mm
4177-21R	2 7/8 REG	V-0.040	5	1:4	60°	69.605mm
4177-3R	3 1/2 REG	V-0.040	5	1:4	60°	82.293mm
4177-4R	4 1/2 REG	V-0.040	5	1:4	60°	110.868mm
4177-5R	5 1/2 REG	V-0.050	4	1:4	60°	132.944mm
4177-6R	6 5/8 REG	V-0.050	4	1:6	60°	146.248mm
4177-7R	7 5/8 REG	V-0.050	4	1:4	60°	170.549mm
4177-8R	8 5/8 REG	V-0.050	4	1:4	60°	194.731mm

Full-hole style gauges

Code	Gauge code	Form of thread to be inspected	Number of thread per inch	Taper	Angle of thread	Basic pitch dia
4177-3H	3 1/2 FH	V-0.040	5	1:4	60°	94.844mm
4177-4H	4 1/2 FH	V-0.040	5	1:4	60°	115.113mm
4177-5H	5 1/2 FH	V-0.050	4	1:6	60°	142.011mm
4177-6H	6 5/8 FH	V-0.050	4	1:6	60°	165.598mm

Internal-flush style gauge

Code	Gauge code	Form of thread to be inspected	Number of thread per inch	Taper	Angle of thread	Basic pitch dia
4177-5F	5 1/2 IF	V-0.065	4	1:6	60°	157.201mm

CASING, TUBING AND LINE PIPE THREAD GAUGES OF PETROLEUM AND GAS EQUIPMENT

Casing round thread gauges

Code	Gauge code	Outer dia	Number of thread per inch	Taper	Angle of thread
4178-4	4 1/2 CSG	114.30mm	8	1:16	60°
4178-4L	4 1/2 LCSG				
4178-5	5 CSG	127.00mm	8	1:16	60°
4178-5L	5 LCSG				
4178-51	5 1/2 CSG	139.70mm	8	1:16	60°
4178-51L	5 1/2 LCSG				
4178-6	6 5/8 CSG	168.28mm	8	1:16	60°
4178-6L	6 5/8 LCSG				
4178-7	7 CSG	177.80mm	8	1:16	60°
4178-7L	7 LCSG				
4178-71	7 5/8 CSG	193.68mm	8	1:16	60°
4178-71L	7 5/8 LCSG				
4178-8	8 5/8 CSG	219.08mm	8	1:16	60°
4178-8L	8 5/8 LCSG				
4178-9	9 5/8 CSG	244.48mm	8	1:16	60°
4178-9L	9 5/8 LCSG				
4178-10	10 3/4 CSG	273.05mm	8	1:16	60°
4178-10L	10 3/4 LCSG				
4178-11	11 3/4 CSG	298.45mm	8	1:16	60°
4178-11L	11 3/4 LCSG				
4178-13	13 3/8 CSG	339.73mm	8	1:16	60°
4178-13L	13 3/8 LCSG				
4178-16	16 CSG	406.40mm	8	1:16	60°
4178-16L	16 LCSG				



4178-21T

- Measure the casing, tubing and line pipe threads

Non-upset tubing thread gauges

Code	Gauge code	Outer dia	Number of thread per inch	Taper	Angle of thread
4178-11T	1.050 TBG	26.67mm	10	1:16	60°
4178-13T	1.315 TBG	33.40mm	10	1:16	60°
4178-16T	1.660 TBG	42.16mm	10	1:16	60°
4178-19T	1.900 TBG	48.26mm	10	1:16	60°
4178-2T	2 3/8 TBG	60.33mm	10	1:16	60°
4178-21T	2 7/8 TBG	73.03mm	10	1:16	60°
4178-3T	3 1/2 TBG	88.90mm	10	1:16	60°
4178-4T	4 TBG	101.60mm	8	1:16	60°
4178-41T	4 1/2 TBG	114.30mm	8	1:16	60°

External-upset tubing thread gauges

Code	Gauge code	Outer dia	Number of thread per inch	Taper	Angle of thread
4178-11U	1.050 UP TBG	26.67mm	10	1:16	60°
4178-13U	1.315 UP TBG	33.40mm	10	1:16	60°
4178-16U	1.660 UP TBG	42.16mm	10	1:16	60°
4178-19U	1.900 UP TBG	48.26mm	10	1:16	60°
4178-2U	2 3/8 UP TBG	60.33mm	8	1:16	60°
4178-21U	2 7/8 UP TBG	73.03mm	8	1:16	60°
4178-3U	3 1/2 UP TBG	88.90mm	8	1:16	60°
4178-4U	4 UP TBG	101.60mm	8	1:16	60°
4178-41U	4 1/2 UP TBG	114.30mm	8	1:16	60°

To be continued

Continued from previous page

Buttress casing thread gauges

Code	Gauge code	Outer dia	Number of thread per inch	Taper	Angle of thread
4178-4B	4 1/2 BCSG	114.30mm	5	1:16	3°, 10°
4178-5B	5 BCSG	127.00mm	5	1:16	3°, 10°
4178-51B	5 1/2 BCSG	139.70mm	5	1:16	3°, 10°
4178-6B	6 5/8 BCSG	168.28mm	5	1:16	3°, 10°
4178-7B	7 BCSG	177.80mm	5	1:16	3°, 10°
4178-71B	7 5/8 BCSG	193.68mm	5	1:16	3°, 10°
4178-8B	8 5/8 BCSG	219.08mm	5	1:16	3°, 10°
4178-9B	9 5/8 BCSG	244.48mm	5	1:16	3°, 10°
4178-10B	10 3/4 BCSG	273.05mm	5	1:16	3°, 10°
4178-11B	11 3/4 BCSG	298.45mm	5	1:16	3°, 10°
4178-13B	13 3/8 BCSG	339.73mm	5	1:16	3°, 10°
4178-16B	16 BCSG	406.40mm	5	1:12	3°, 10°

Line pipe thread gauges

Code	Gauge code	Outer dia	Number of thread per inch	Taper	Angle of thread
4178-01P	1/8 LP	3.18mm	27	1:16	60°
4178-02P	1/4 LP	6.35mm	18	1:16	60°
4178-03P	3/8 LP	9.53mm	18	1:16	60°
4178-05P	1/2 LP	12.70mm	14	1:16	60°
4178-07P	3/4 LP	19.05mm	14	1:16	60°
4178-10P	1 LP	25.40mm	11 1/2	1:16	60°
4178-12P	1 1/4 LP	31.75mm	11 1/2	1:16	60°
4178-15P	1 1/2 LP	38.10mm	11 1/2	1:16	60°
4178-20P	2 LP	50.80mm	11 1/2	1:16	60°
4178-25P	2 1/2 LP	63.50mm	8	1:16	60°
4178-30P	3 LP	76.20mm	8	1:16	60°
4178-35P	3 1/2 LP	88.90mm	8	1:16	60°
4178-40P	4 LP	101.60mm	8	1:16	60°
4178-50P	5 LP	127.00mm	8	1:16	60°
4178-60P	6 LP	152.40mm	8	1:16	60°
4178-80P	8 LP	203.20mm	8	1:16	60°
4178-100P	10 LP	254.00mm	8	1:16	60°

**SEMI-AUTOMATIC THREAD INSPECTOR
CODE TGI**

CUSTOM-MADE

- Rapid inspection of thread
- Speed and torque are adjustable
- Reverse button: if abnormal thread is detected, thread gauge will be stuck, press the reverse button to exit
- Different thread gauges and workpiece fixtures can be replaced
- Thread gauges with DLC coating, excellent wear resistance
- For different length of thread by adjusting the position of approach switch
- Optional accessory: GO thread plug gauges, GO thread ring gauges, thread plug gauge fixtures, custom-made workpiece fixtures

SPECIFICATION

Measuring range	external thread: M5~M20 (Go thread ring gauges)
	internal thread: M3~M36 (Go thread plug gauges)
Torque range	clearance fit: 0.1~0.35Nm, interference fit: 0.4~1.4Nm
Speed range	100~2200r/min
Power supply	power adapter
Rated power	24W
Weight	3kg
Dimension	160×190×250mm



GO thread ring gauge (optional)



CUSTOM-MADE

AUTOMATIC THREAD INSPECTION MACHINE CODE TCM



- For inspection of GO, NO-GO and depth of threads
- Can be for repair of thread defects
- Real-time display of torque, circles, OK and NG counts
- If NG thread is detected, audible and visual alarm are activated and the motor is automatically reversed to exit the thread gauge
- Different thread gauges and workpiece fixtures can be replaced
- For different length of thread by adjusting the induction switch
- Thread gauges with DLC coating, excellent wear resistance
- Optional accessory: thread plug gauges, thread ring gauges, thread gauge fixtures, custom-made workpiece fixtures, foot switch (code TCM-T20-01)

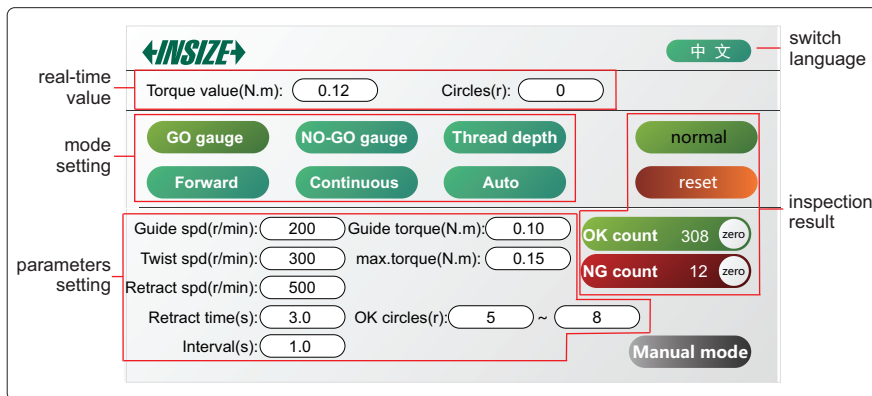
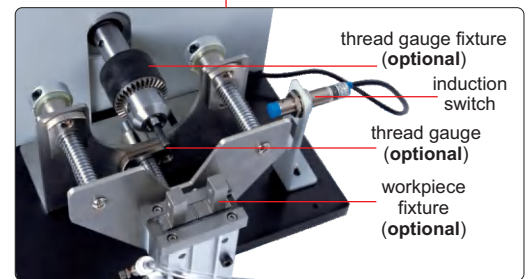
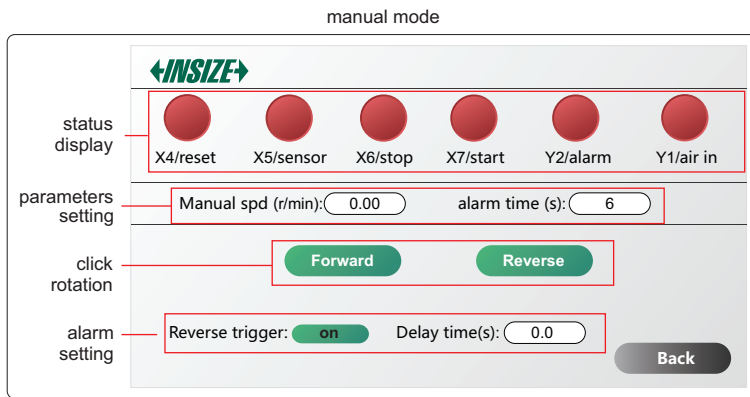

SPECIFICATION

Measuring range	thread: M1~M30
Reprocessing range	thread: M1~M20
Torque range	guide torque: 0~1.27N.m, max. torque: 0~1.27N.m
Speed range	0~3000 r/min
Time range	retract time: 0.1~99s, interval: 0.1~99s
Power supply	220V, 50/60Hz
Rated power	400W
Weight	13kg
Dimension	460x290x330mm

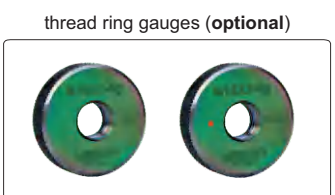
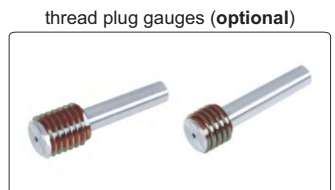

EXTERNAL THREAD MEASURING DEVICE CODE ISQ-TE100

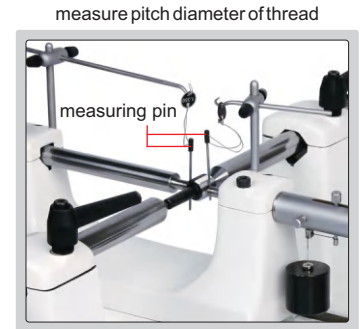
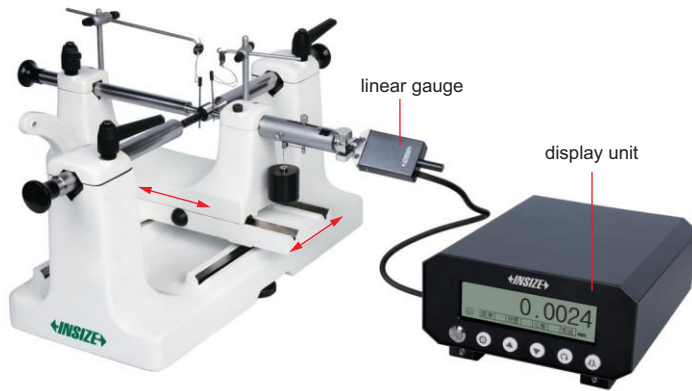

- Quickly measure major, pitch and minor diameters of external thread
- Suitable for metric, inch, whitworth, NPT and BSPT

SPECIFICATION

Code	Range	Resolution	Accuracy	Repeatability
ISQ-TE100	0-100mm	0.1µm	2µm	0.5µm

OPTIONAL ACCESSORY

Measuring pin	ISQ-TE100-A
Measuring prism	ISQ-TE100-B
Female center	ISQ-TE100-C
Clamp	ISQ-TE100-D
Setting disc	ISQ-TE100-E
60° find pointer	ISQ-TE100-F
55° find pointer	ISQ-TE100-G
Display unit	7131-1A
Linear gauge	7131-01

Measuring pin (optional)



- To measure pitch diameter of external thread
- Each size is supplied in pair
- Hardness: 60±2HRC

Code	Pins included	Pin diameter (mm)
ISQ-TE100-A	21 pairs	0.170, 0.195, 0.220, 0.250, 0.290, 0.335, 0.390, 0.455, 0.530, 0.620, 0.725, 0.895, 1.100, 1.350, 1.650, 2.050, 2.550, 3.200, 4.000, 5.050, 6.350

Measuring prism (optional)



- To measure minor diameter of external thread
- Each size is supplied in pair

Code	Prisms included	Size
ISQ-TE100-B	4 pairs	A, B, C, D (for different types and sizes of thread)

Setting disc (optional)



- To set initial value

Code	Discs included	Disc diameter (mm)
ISQ-TE100-E	22 pcs	3, 5, 8, 12, 16, 20, 24, 30, 35, 40, 45, 50, 55, 60, 65, 70, 75, 80, 85, 90, 95, 100

To be continued

Continued from previous page

Female center (optional)

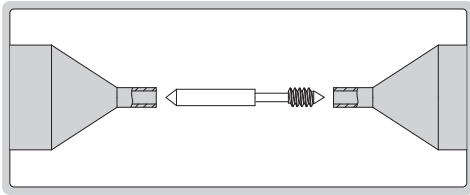

- With small holes to support small workpieces without female centers
- Supplied in pair

Code
ISQ-TE100-C

Find pointer (optional)

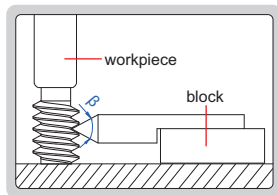

- To find measuring point of NPT or BSPT

Code	Angle β	Applicable thread
ISQ-TE100-F	60°	NPT
ISQ-TE100-G	55°	BSPT

Display unit (optional)



Code	7131-1A
Display mode	4" LCD
Display unit	mm, μ m
Resolution	0.1 μ m

Clamp (optional)

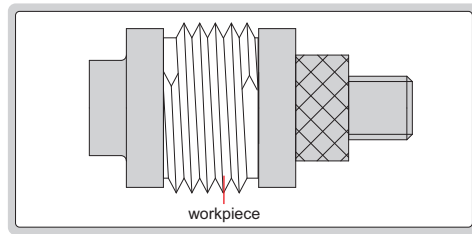
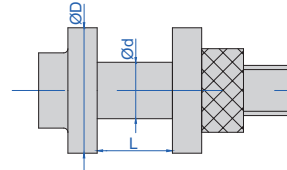

- To hold large workpieces with inner bore

(mm)

Code	Clamps included	$\varnothing d$	$\varnothing D$	L
ISQ-TE100-D	3 pcs	13.5	30	0-18
		23	60	0-18
		23	75	0-18

Linear gauge (optional)

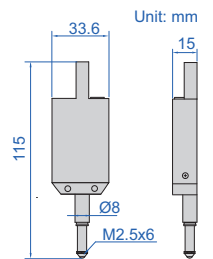

Code	7131-01
Measuring range	12.5mm
Resolution	0.1 μ m
Accuracy	1 μ m
Repeatability	0.2 μ m

13

ANGLE, STRAIGHTNESS, FLATNESS MEASURING TOOLS



Angle Meters
Page 410



Protractors
Page 410-415



Granite Squares
Page 415-416



Cylinder Squares
Page 416



Perpendicularity Testers
Page 417

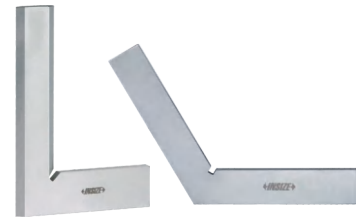

Squares
Page 417-423



Straight Edges
Page 423



Straight Edges
Page 424-425



Optical Flats
Page 425



Flatness Measurement Stands
Page 426



DIGITAL ANGLE METER CODE 2177-121



- Clockwise and counter-clockwise operation
- 9 target angle values can be set, with audible and visible alarm:
 - Green LED light on and buzzer sounds when angle value is 80%~99.5% of target angle
 - Both green and red LED light on and buzzer sounds when angle value is over 99.5% of target angle
- Memory of 250 results, can upload to the computer
- Back with magnet
- Power off in 2 minutes automatically

SPECIFICATION

Display range	0~999°
Setting range	1~360° (increment 1°)
Resolution	0.1°
Accuracy	±2° for 90° rotation @30°/sec
Power supply	2×1.5V AAA batteries
Dimension	58×58×41mm
Weight	70g

measurement of angle rotation in any direction (gyro technique)

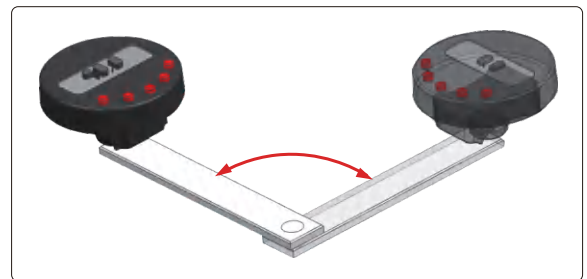

WATERPROOF DIGITAL PROTRACTOR (HEAVY DUTY)

AUTOMATIC
BACKLIGHT

ABSOLUTE
LEVEL

IP54
WATERPROOF

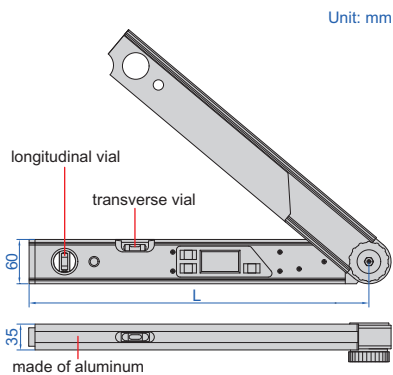

2174-225

- Suitable for setting horizontal and vertical mitre angles of cutting machines
- Buttons: ON/OFF, HOLD/SUP, SPR/CNR/MTR/BVL
- IP54 dust/waterproof
- With transverse and longitudinal vials
- 2xAAA batteries
- Absolute level, zero setting is not needed when batteries are replaced
- Backlight turns off in one minute after reading is stable, automatic power off in 5 minutes

Code	Size (L)	Range	Resolution	Accuracy
2174-225	460mm	0-225°	0.05°	±0.10°

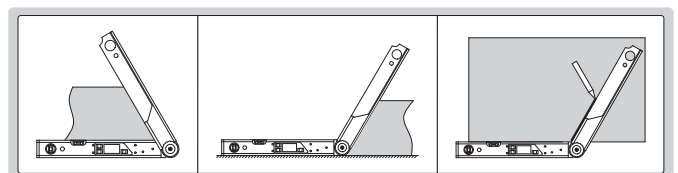

DIGITAL PROTRACTOR



2171-250

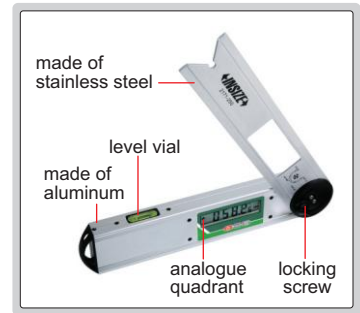
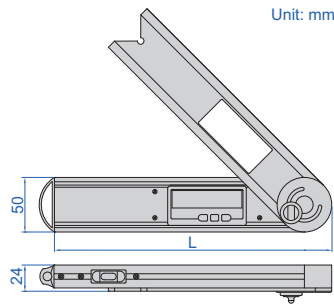

- Buttons: on/off, hold (keep the reading), zero, ABS (absolute and incremental measurement)
- Fix the locking screw at 4 positions for different measuring ranges: 0°~225°, -225°~0°, -45°~180°, -180°~45°
- Remove the locking screw for 360° range
- With level vial
- Battery CR2032, automatic power off

Code	Size (L)	Range	Resolution	Accuracy
2171-250	250mm	0-360°	0.05°	±0.15°

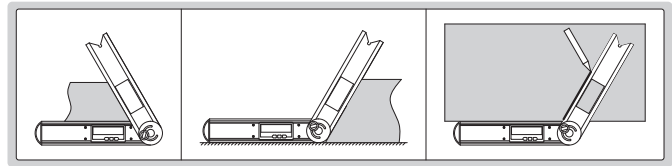

DIGITAL PROTRACTORS



2176-200

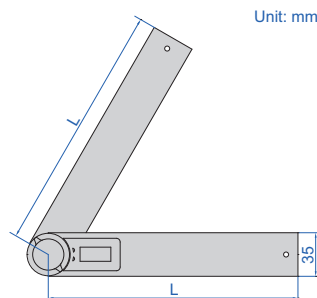

- Buttons: on/off, zero
- With clamping screw to lock the blades
- Graduation of blade: 1mm and 1/32"
- Made of stainless steel
- CR2032 battery
- Automatic power off

Code	Size (L)	Range	Resolution	Accuracy
2176-200	200mm	0-360°	0.1°	±0.3°
2176-300	300mm	0-360°	0.1°	±0.3°

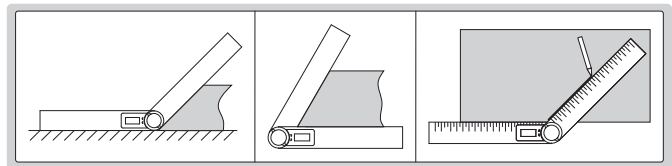

DIGITAL LEVELS AND SLOPE METERS

REFER TO PAGE 541-545 FOR DETAILS



2179-360



2175-360



2199-1



2170-1

PROTRACTOR (ECONOMIC TYPE)

- Graduation: 1°
- Made of stainless steel
- With clamping screw



4780-85A

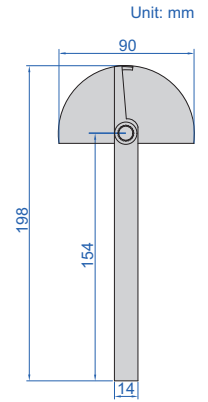

Code	Size	Range	Accuracy
4780-85A	90x154mm	0-180°	±0.5°

PROTRACTOR

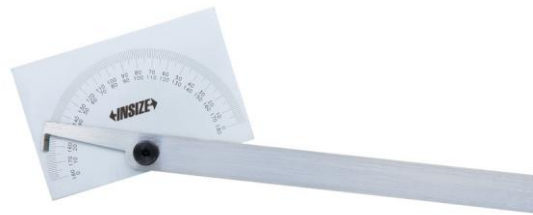
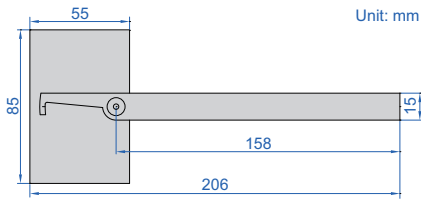

4781-85A

- Made of stainless steel
- Satin chrome plated scale
- With clamping screw

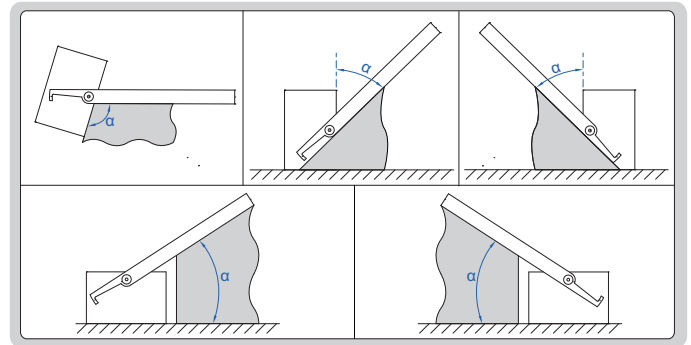

Code	Size	Range	Graduation	Accuracy
4781-85A	85x158mm	0-180°	1°	±0.3°

PROTRACTORS

- Graduation: 1°
- Made of stainless steel (4799-1300 is made of carbon steel)
- Satin chrome plated scale
- With clamping screw



4799-180

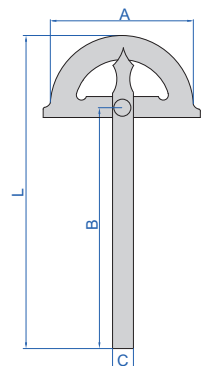

Code	Size (AxB)	Range	Accuracy	L	C
4799-180	80x120mm	0-180°	±0.3°	168mm	11mm
4799-1120	120x150mm	0-180°	±0.3°	220mm	14mm
4799-1150	150x200mm	0-180°	±0.3°	285mm	16mm
4799-1200	200x300mm	0-180°	±0.3°	413mm	20mm
4799-1300	300x500mm	0-180°	±0.3°	675mm	30mm

PROTRACTORS

- Graduation: 1°
- Made of carbon steel
- Satin chrome plated
- With clamping screw
- The blade is moveable



4797-100

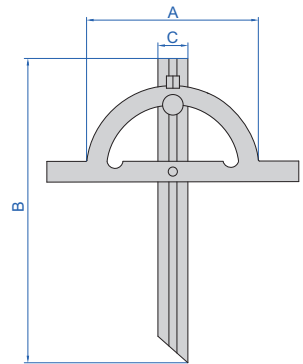

Code	Size (AxB)	Range	Accuracy	C
4797-100	100x150mm	10-170°	±0.3°	18mm
4797-150	150x300mm	10-170°	±0.3°	22mm
4797-200	200x400mm	10-170°	±0.3°	24mm
4797-250	250x500mm	10-170°	±0.3°	28mm
4797-300	300x600mm	10-170°	±0.3°	32mm

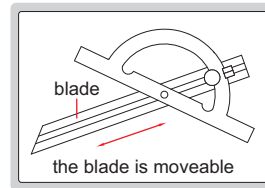

PROTRACTORS

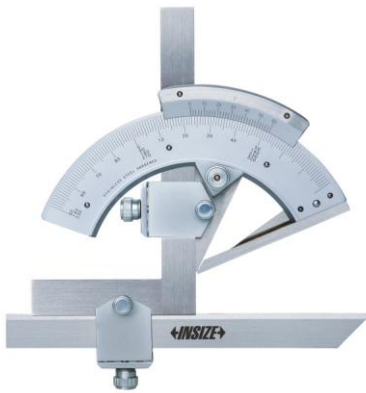

2374-320

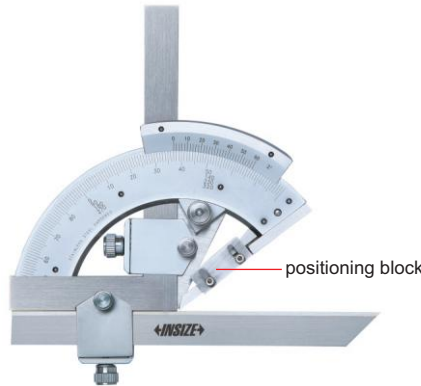

2374-320D

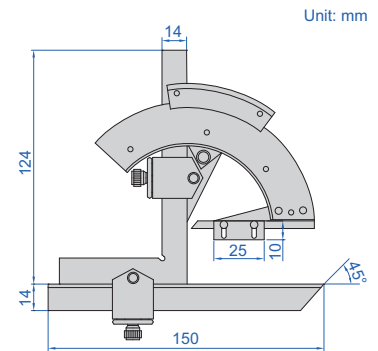

Unit: mm

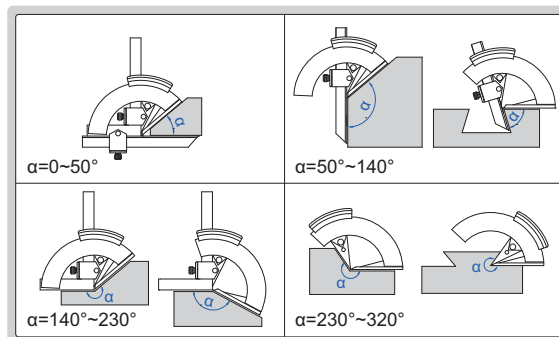

- Made of stainless steel
- Satin chrome plated scale

Code	Range	Graduation	Accuracy	Remark
2374-320	0-320°	2'	±2'	without positioning block
2374-320D	0-320°	2'	±2'	with positioning block

application of 2374-320D

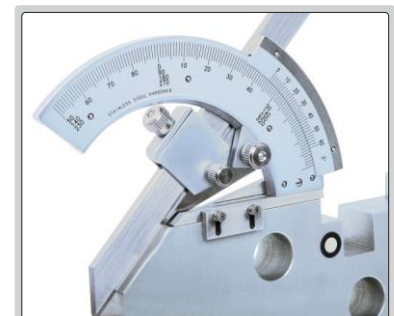

the positioning block can be moved down for positioning, and moved up when not in use

UNIVERSAL PROTRACTOR

clamp for height gauges (optional)

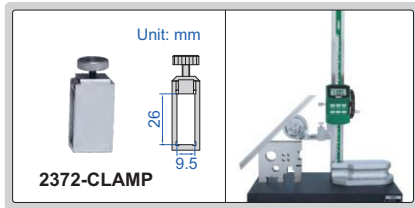

- Parallax-free reading
- Made of stainless steel
- Optional accessory: clamp (code **2372-CLAMP**), suitable for height gauges **1156**, **1150-300**, **1351**, **1250** and **1151**

Code	Range	Graduation	Accuracy
2372-360	0-360°	5'	±5'

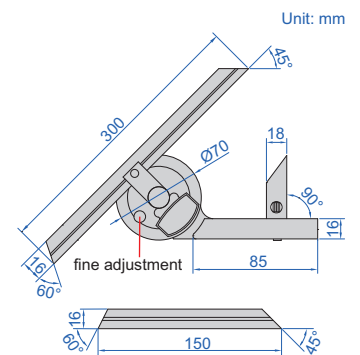
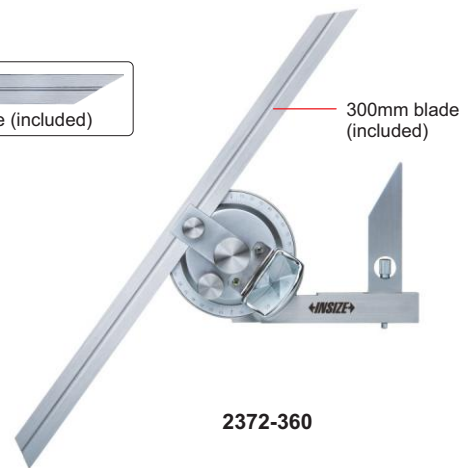
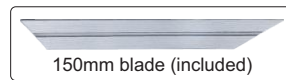

DIAL PROTRACTOR

clamp for height gauges (optional)

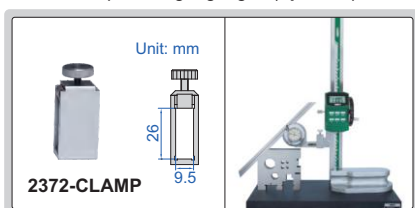

- Made of stainless steel
- Optional accessory: clamp (code **2372-CLAMP**), suitable for height gauges **1156**, **1150-300**, **1351**, **1250** and **1151**

Code	Range	Graduation	Accuracy
2373-360	0-360°	5'	±5'

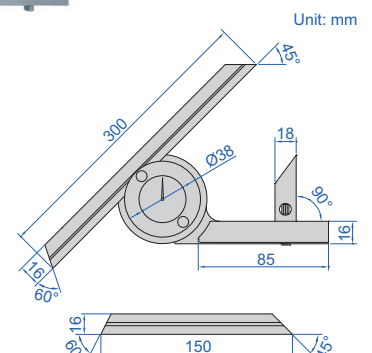
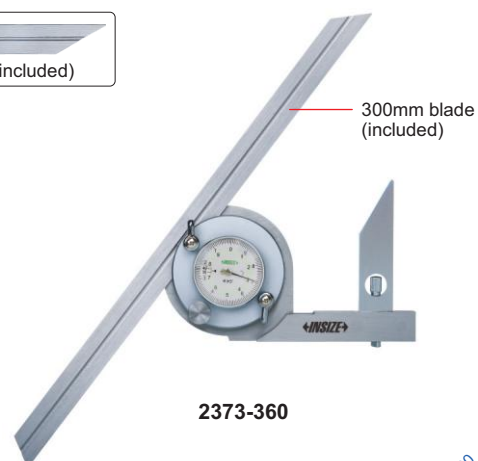
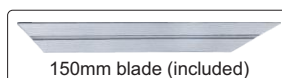

DIGITAL PROTRACTOR

POPULAR MODEL

DATA OUTPUT

ABSOLUTE ZERO

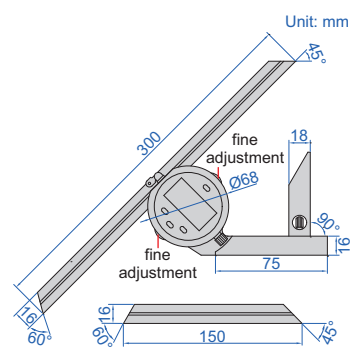
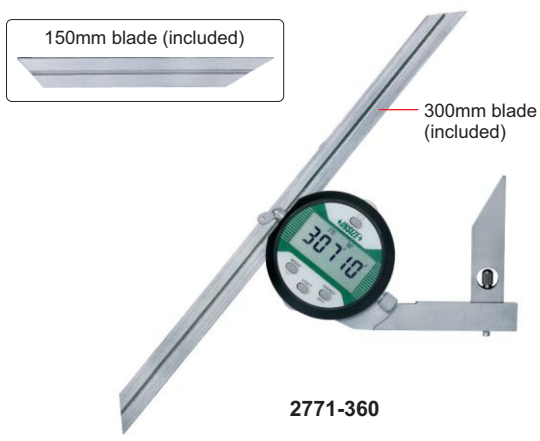

- Absolute zero, zero setting is not needed when batteries are replaced
- Button function: choose 0-90°, 0-180° or 0-360° display, change resolution, display flips over, data hold, zero, on/off supplementary angle measurement
- Battery CR2032, automatic power off, data output
- Made of stainless steel
- Optional square for zero setting
- Optional accessory: clamp (code **2372-CLAMP**), suitable for height gauges **1156**, **1150-300**, **1351**, **1250** and **1151**, wireless transmitter code **7315-2771** (receiver is needed) page 8, data output cable code **7302-50M** page 21

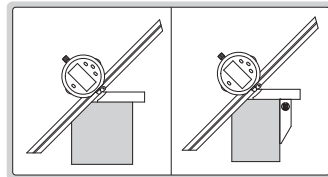

square (optional)

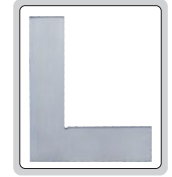

clamp for height gauges (optional)

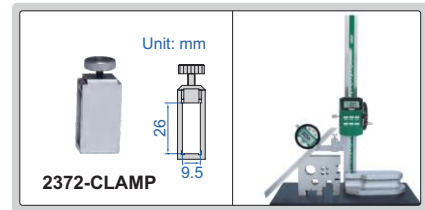

Square (for zero setting, optional)

Code
2771-S90

13

Code	Range	Resolution	Accuracy
2771-360	0-360°	1/0.01°	±5'

GRANITE SQUARE

CUSTOM-MADE
SUPPLY SPECIAL SIZES ACCORDING
TO CUSTOMER'S REQUEST

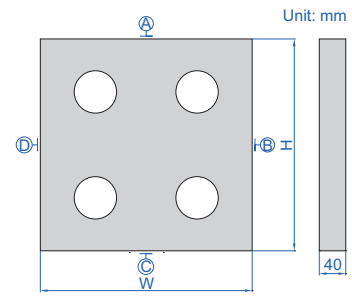

Code	Size (HxW)	Flatness of A, B, C and D	Squareness and parallelism between A, B, C and D
4144-315	315x315mm	1.1µm	2.6µm

CUSTOM-MADE
SUPPLY SPECIAL SIZES ACCORDING
TO CUSTOMER'S REQUEST

GRANITE SQUARES



4141-250



4141-400B

Code	Size (HxW)	Type	Flatness of A	Flatness of B	Squareness of A to B	D
4141-250	250x160mm	A	1µm	1µm	2µm	25mm
4141-400	400x250mm	A	1.5µm	1µm	3µm	40mm
4141-630	630x400mm	A	2µm	1.5µm	4µm	63mm
4141-400B	400x250mm	B	1.5µm	1µm	3µm	40mm

INSPECTION
CERTIFICATE

- Made of special alloy steel, hardness HRC58~60
- The handle can be removed

Code	Length (L)	Squareness
4710-200 *	200mm	1µm
4710-300 *	300mm	2µm

* Supplied with manufacturer inspection certificate

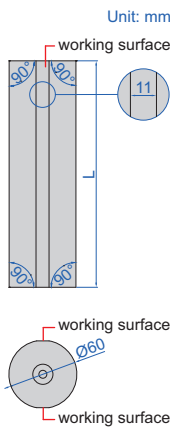

4710-200

CYLINDER SQUARES

inspect 90° internal and external angles

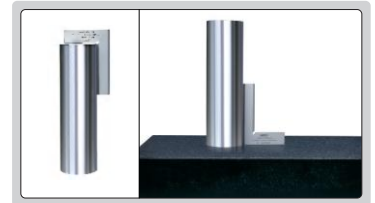

CYLINDER SQUARES

- DIN875
- Made of special alloy steel, hardness >HRC58
- The handle can be removed

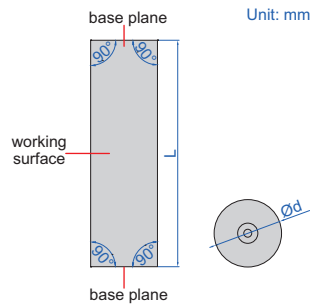

4712-200

inspect 90° internal and external angles

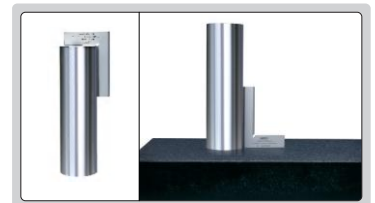

Code	Length (L)	Diameter(Ød)	Squareness
4712-200	200mm	80mm	4µm
4712-315	315mm	100mm	5µm
4712-500	500mm	100mm	7µm

PERPENDICULARITY TESTERS

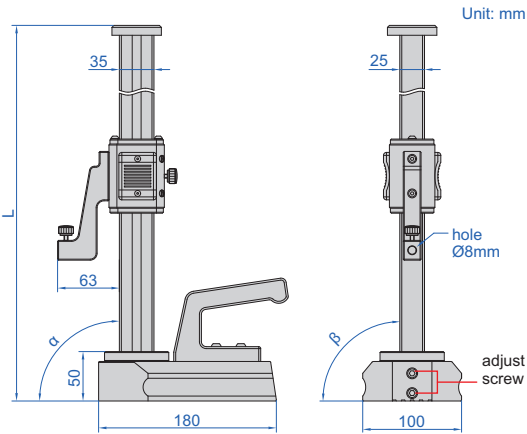

4770-300

- Optional accessory: dial test indicators (graduation: 1µm or 2µm)

Code	Range (H)	Perpendicularity (α)	Side perpendicularity (β)	L
4770-300	0-300mm	3µm	10µm	460mm
4770-600	0-600mm	5µm	20µm	760mm



90° BEVELED EDGE SQUARES

13

- Satin chrome plating
- Beveled edges for inside and outside measurements
- Made of hardened stainless steel

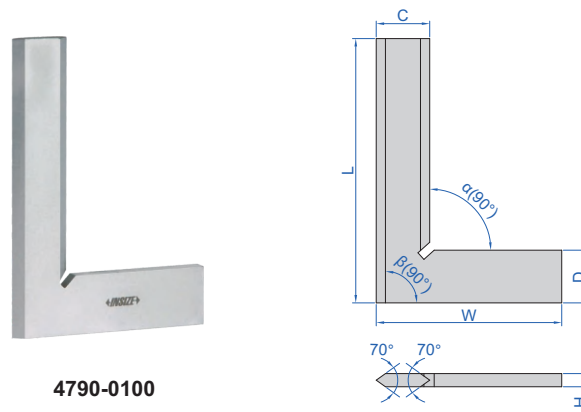

4790-0100

DIN875 grade 00 (mm)

Code	Size (LxW)	Squareness		C	D	H
		Inside (α)	Outside (β)			
4790-050	50x40mm	2.4µm	2.5µm	13	13	4
4790-075	75x50mm	2.6µm	2.8µm	15	15	4
4790-0100	100x70mm	2.8µm	3.0µm	20	20	5
4790-0150	150x100mm	3.2µm	3.5µm	30	30	6
4790-0200	200x130mm	3.7µm	4.0µm	34	34	7
4790-0250	250x165mm	4.2µm	4.5µm	35	35	7
4790-0300	300x200mm	4.6µm	5.0µm	40	40	8

DIN875 grade 0 (mm)

Code	Size (LxW)	Squareness		C	D	H
		Inside (α)	Outside (β)			
4790-500	50x40mm	6µm	6µm	13	13	4
4790-750	75x50mm	6µm	7µm	15	15	4
4790-1000	100x70mm	7µm	7µm	20	20	5
4790-1500	150x100mm	7µm	8µm	30	30	6
4790-2000	200x130mm	8µm	9µm	34	34	7
4790-2500	250x165mm	9µm	10µm	35	35	7
4790-3000	300x200mm	10µm	11µm	40	40	8



90° TOOL MAKER SQUARES

- DIN875 grade 00
- Beveled edge for inside measurement
- Made of hardened stainless steel

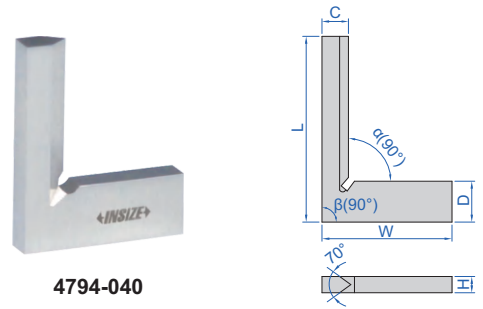

4794-040

Code	Size (LxW)	Squareness		C	D	H
		Inside (α)	Outside (β)			
4794-025	25x20mm	2.2 μ m	2.3 μ m	4	6.5	3.5
4794-040	40x28mm	2.3 μ m	2.4 μ m	5.5	8.5	3.5

90° FLAT EDGE SQUARES

- Made of hardened stainless steel

DIN875 grade 0 (mm)

Code	Size (LxW)	Squareness		C	D	H
		Inside (α)	Outside (β)			
4791-50	50x40mm	6 μ m	6 μ m	15	15	4
4791-75	75x50mm	6 μ m	7 μ m	15	15	4
4791-100	100x70mm	7 μ m	7 μ m	20	20	5
4791-150	150x100mm	7 μ m	8 μ m	30	30	6
4791-200	200x130mm	8 μ m	9 μ m	30	30	7
4791-250	250x165mm	9 μ m	10 μ m	35	35	7
4791-300	300x200mm	10 μ m	11 μ m	40	40	8



4791-100

DIN875 grade 1 (mm)

Code	Size (LxW)	Squareness		C	D	H
		Inside (α)	Outside (β)			
4791-501	50x40mm	12 μ m	13 μ m	15	15	4
4791-751	75x50mm	13 μ m	14 μ m	15	15	4
4791-1001	100x70mm	14 μ m	15 μ m	20	20	5
4791-1501	150x100mm	16 μ m	18 μ m	30	30	6
4791-2001	200x130mm	19 μ m	20 μ m	30	30	7
4791-2501	250x165mm	21 μ m	23 μ m	35	35	7
4791-3001	300x200mm	23 μ m	25 μ m	40	40	8

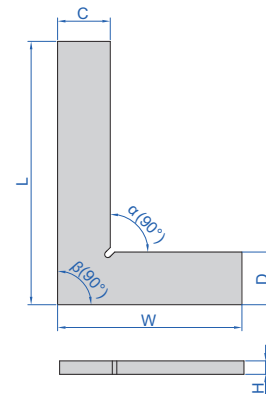

DIN875 grade 2 (mm)

Code	Size (LxW)	Squareness		C	D	H
		Inside (α)	Outside (β)			
4791-502	50x40mm	24 μ m	25 μ m	15	15	4
4791-752	75x50mm	26 μ m	28 μ m	15	15	4
4791-1002	100x70mm	28 μ m	30 μ m	20	20	5
4791-1502	150x100mm	33 μ m	35 μ m	30	30	6
4791-2002	200x130mm	38 μ m	40 μ m	30	30	7
4791-2502	250x165mm	43 μ m	45 μ m	35	35	7
4791-3002	300x200mm	47 μ m	50 μ m	40	40	8

MACHINIST SQUARES (ECONOMIC TYPE)

ATTENTION: NO ANTI-RUST TREATMENT, NOT HARDEND

- DIN875 grade 2
- Made of carbon steel, no anti-rust treatment, not hardend

Code	Size (LxW)	Squareness		C	D	H	
		Inside (α)	Outside (β)				
4796-50	50x30mm	24 μ m	25 μ m	12	12	3	
4796-75	75x50mm	26 μ m	28 μ m	16	16	3	
4796-100	100x70mm	28 μ m	30 μ m	19	19	5	
4796-125	125x80mm	30 μ m	33 μ m	22	22	5	
4796-150	150x100mm	33 μ m	35 μ m	25	25	6	
4796-200	200x130mm	38 μ m	40 μ m	25	25	6	
4796-250	250x165mm	43 μ m	45 μ m	25	25	6	
4796-300	300x200mm	47 μ m	50 μ m	30	30	6	
4796-350	350x200mm	51 μ m	55 μ m	38	38	6	
4796-400	400x200mm	56 μ m	60 μ m	38	38	9	
4796-450	450x250mm	58 μ m	65 μ m	38	38	9	
4796-500	500x300mm	69 μ m	70 μ m	38	38	9	

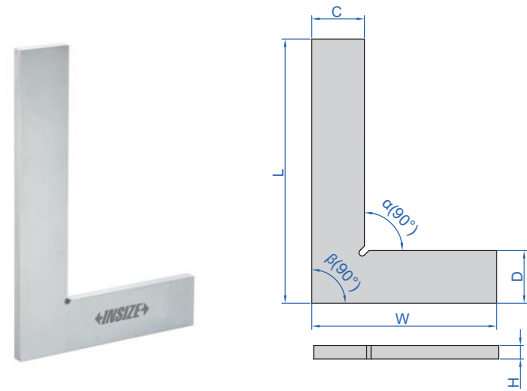

4796-150

90° FLAT EDGE SQUARES WITH WIDE BASE

- Made of hardened stainless steel

DIN875 grade 0 (mm)

Code	Size (LxW)	Squareness		C	D	H	E
		Inside (α)	Outside (β)				
4793-50	50x40mm	6 μ m	6 μ m	15	15	4	13
4793-75	75x50mm	6 μ m	7 μ m	15	15	4	15
4793-100	100x70mm	7 μ m	7 μ m	20	20	5	20
4793-150	150x100mm	7 μ m	8 μ m	30	30	6	30
4793-200	200x130mm	8 μ m	9 μ m	30	30	7	30
4793-250	250x165mm	9 μ m	10 μ m	35	35	7	35
4793-300	300x200mm	10 μ m	11 μ m	40	40	8	40



4793-100

DIN875 grade 1 (mm)

Code	Size (LxW)	Squareness		C	D	H	E
		Inside (α)	Outside (β)				
4793-501	50x40mm	12 μ m	13 μ m	15	15	4	13
4793-751	75x50mm	13 μ m	14 μ m	15	15	4	15
4793-1001	100x70mm	14 μ m	15 μ m	20	20	5	20
4793-1501	150x100mm	16 μ m	18 μ m	30	30	6	30
4793-2001	200x130mm	19 μ m	20 μ m	30	30	7	30
4793-2501	250x165mm	21 μ m	23 μ m	35	35	7	35
4793-3001	300x200mm	23 μ m	25 μ m	40	40	8	40

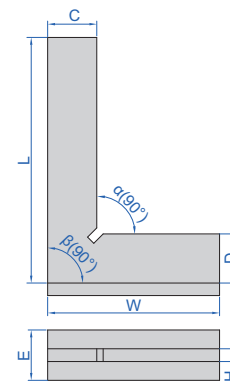

DIN875 grade 2 (mm)

Code	Size (LxW)	Squareness		C	D	H	E
		Inside (α)	Outside (β)				
4793-502	50x40mm	24 μ m	25 μ m	15	15	4	13
4793-752	75x50mm	26 μ m	28 μ m	15	15	4	15
4793-1002	100x70mm	28 μ m	30 μ m	20	20	5	20
4793-1502	150x100mm	33 μ m	35 μ m	30	30	6	30
4793-2002	200x130mm	38 μ m	40 μ m	30	30	7	30
4793-2502	250x165mm	43 μ m	45 μ m	35	35	7	35
4793-3002	300x200mm	47 μ m	50 μ m	40	40	8	40



90° FLAT EDGE SQUARES WITH WIDE BASE

- DIN875 grade 0
- Made of hardened stainless steel

Code	Size (LxW)	Squareness		C	D	H	E
		Inside (α)	Outside (β)				
4792-50	50x40mm	6 μ m	6 μ m	12	12	3	10
4792-75	75x50mm	6 μ m	7 μ m	14	14	3	10
4792-100	100x70mm	7 μ m	7 μ m	18	18	3	10
4792-150	150x100mm	8 μ m	8 μ m	22	22	4	12
4792-200	200x130mm	9 μ m	9 μ m	25	25	4	12

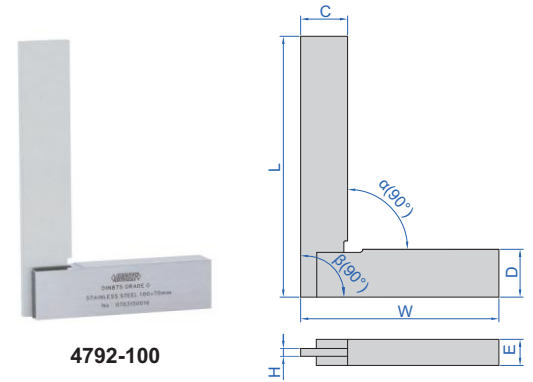

4792-100

ATTENTION: NO ANTI-RUST TREATMENT, NOT HARDEND

MACHINIST SQUARES WITH WIDE BASE (ECONOMIC TYPE)

- DIN875 grade 2
- Made of carbon steel, no anti-rust treatment, not hardend

Code	Size (LxW)	Squareness		C	D	H	E
		Inside (α)	Outside (β)				
4707-50	50x40mm	24 μ m	25 μ m	16	12	3	9
4707-75	75x50mm	26 μ m	28 μ m	16	16	3	9
4707-100	100x70mm	28 μ m	30 μ m	19	19	3	12
4707-150	150x100mm	33 μ m	35 μ m	25	25	3	16
4707-200	200x130mm	37 μ m	40 μ m	30	32	4	16
4707-250	250x165mm	42 μ m	45 μ m	30	32	4	19
4707-300	300x200mm	47 μ m	50 μ m	32	32	4	19
4707-400	400x250mm	56 μ m	60 μ m	38	38	5	22
4707-500	500x300mm	65 μ m	70 μ m	45	50	6	25
4707-600	600x350mm	75 μ m	80 μ m	50	50	6	30
4707-750	750x400mm	90 μ m	95 μ m	55	55	6	50
4707-900	900x500mm	103 μ m	110 μ m	65	75	9	50
4707-1000	1000x550mm	113 μ m	120 μ m	65	75	9	50

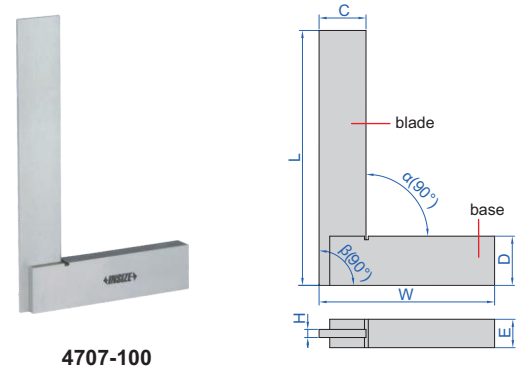

4707-100

90° BEVELED EDGE SQUARES WITH WIDE BASE

- DIN875 grade 0
- Beveled edges for inside and outside measurements
- Made of hardened stainless steel

Code	Size (LxW)	Squareness		C	D	H	E
		Inside (α)	Outside (β)				
4795-50	50x40mm	6 μ m	6 μ m	12	12	3	10
4795-75	75x50mm	6 μ m	7 μ m	14	14	3	10
4795-100	100x70mm	7 μ m	7 μ m	18	18	3	10
4795-150	150x100mm	8 μ m	8 μ m	22	22	4	12
4795-200	200x130mm	9 μ m	9 μ m	25	25	4	12

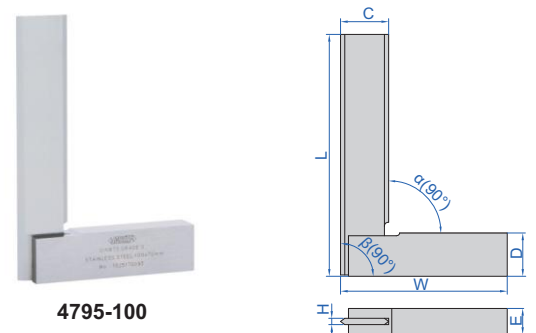

4795-100

TRY SQUARE

- Graduation: 1mm
- Stainless steel blade, aluminum base

Code	Size (LxW)	Squareness	
		Inside (α)	Outside (β)
2275-300	300x170mm	0.5mm	0.5mm



2275-300

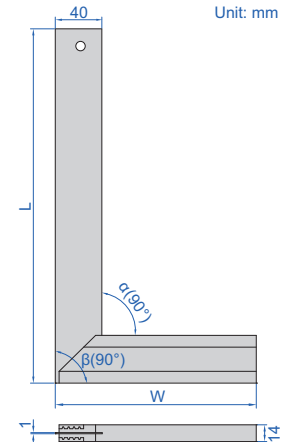

TRY SQUARE

- Graduation: 1mm
- Aluminum blade and base
- 4 milled surfaces
- Retractable metal ledge support
- Etchings and holes for beveling and framing: 10°, 15°, 22.5°, 30°, 45°, 50° and 60°
- Etchings and holes every cm for fluid pencil marking

Code	Size (LxW)	Squareness	
		Inside (α)	Outside (β)
2280-300	300x150mm	0.5mm	0.5mm

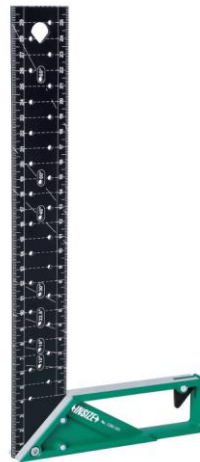

2280-300

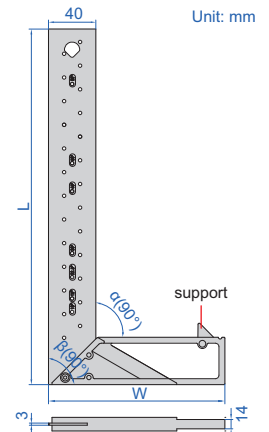

13

ADJUSTABLE SQUARE

- The straight edge can move and can be locked by the clamping screw
- Made of hardened stainless steel

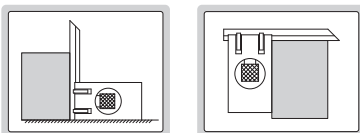

4701-1

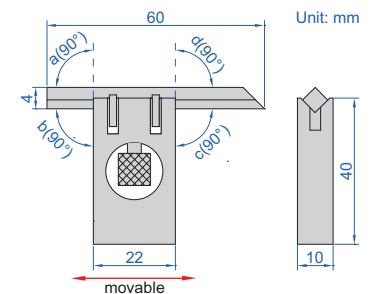

Code	Squareness (a, b, c, d)
4701-1	7 μ m

45° SQUARES

- Made of hardened stainless steel

Code	Size (LxW)	Accuracy		C	D	H
		Inside (α)	Outside (β)			
4745-1100	100x70mm	27 μ m	30 μ m	20	20	5
4745-1120	120x80mm	29 μ m	32 μ m	20	20	5
4745-1150	150x100mm	32 μ m	35 μ m	20	20	5
4745-1200	200x130mm	36 μ m	40 μ m	25	25	5

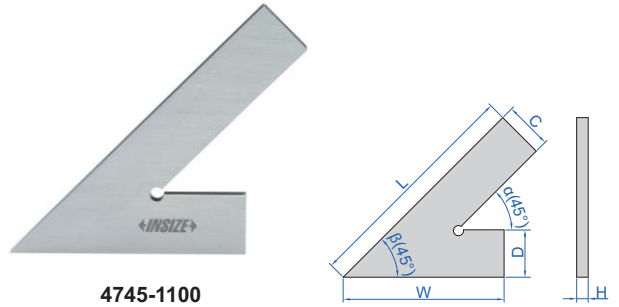

4745-1100

45° SQUARES WITH WIDE BASE

- Made of hardened stainless steel

Code	Size (LxW)	Accuracy		C	D	H	E
		Inside (α)	Outside (β)				
4747-100	100x70mm	27 μ m	30 μ m	20	20	5	20
4747-120	120x80mm	29 μ m	32 μ m	20	20	5	20
4747-150	150x100mm	32 μ m	35 μ m	20	20	5	20
4747-200	200x130mm	36 μ m	40 μ m	25	25	5	25

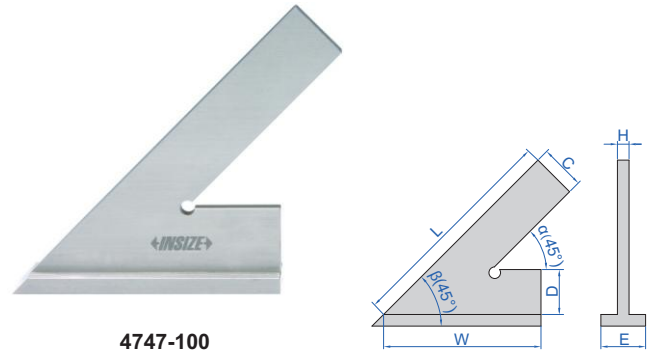

4747-100

60° SQUARES

- Made of hardened stainless steel

Code	Size (LxW)	Accuracy		C	D	H
		Inside (α)	Outside (β)			
4760-1120	120x80mm	30 μ m	32 μ m	20	20	5
4760-1150	150x100mm	32 μ m	35 μ m	20	20	5
4760-1200	200x130mm	37 μ m	40 μ m	25	25	5

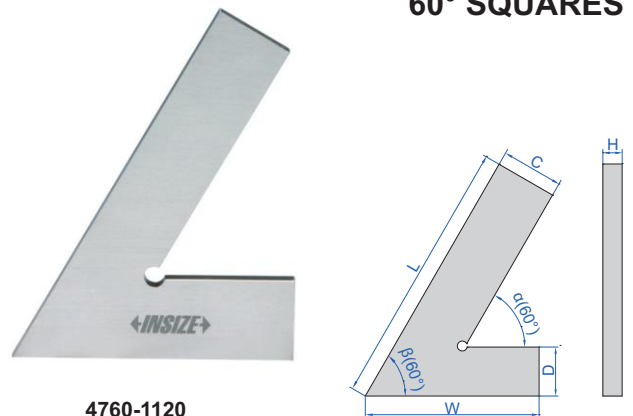

4760-1120

60° SQUARES WITH WIDE BASE

- Made of hardened stainless steel

Code	Size (LxW)	Accuracy		C	D	H	E
		Inside (α)	Outside (β)				
4762-120	120x80mm	30 μ m	33 μ m	20	20	5	20
4762-150	150x100mm	33 μ m	36 μ m	20	20	5	20
4762-200	200x130mm	37 μ m	41 μ m	25	25	5	25

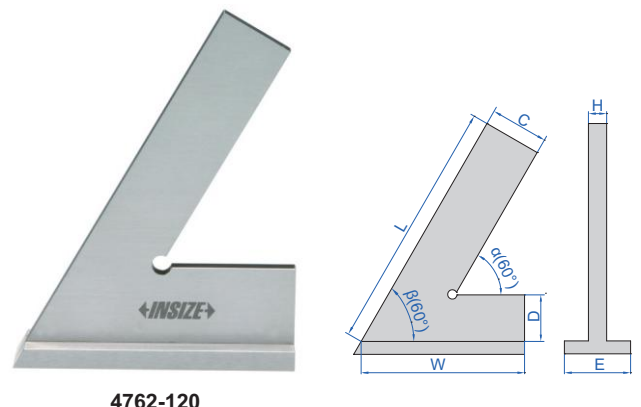

4762-120

120° SQUARES



4706-1100

- Made of hardened stainless steel

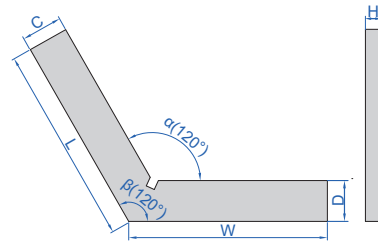

(mm)

Code	Size (LxW)	Accuracy		C	D	H
		Inside (α)	Outside (β)			
4706-150	50x50mm	24 μ m	25 μ m	15	15	5
4706-175	75x75mm	26 μ m	28 μ m	20	20	5
4706-1100	100x100mm	29 μ m	30 μ m	20	20	5

135° SQUARES WITH WIDE BASE



4754-3120

- Made of hardened stainless steel

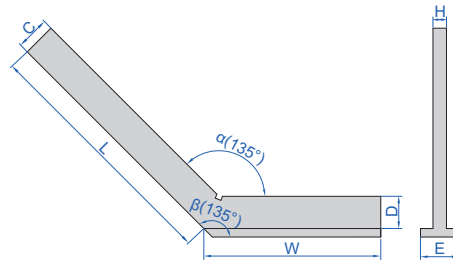

(mm)

Code	Size (LxW)	Accuracy		C	D	H	E
		Inside (α)	Outside (β)				
4754-3120	120x80mm	31 μ m	33 μ m	20	20	5	20
4754-3150	150x100mm	34 μ m	36 μ m	20	20	5	20
4754-3200	200x130mm	39 μ m	41 μ m	30	30	7	30

STRAIGHT EDGES

13



4700-100

- DIN874
- Beveled edge
- Made of hardened stainless steel
- Satin chrome plating

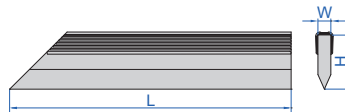

Code	Size (L)	Straightness	W	H
4700-50	50mm	2.2 μ m	5mm	25mm
4700-75	75mm	2.3 μ m	5mm	25mm
4700-100	100mm	2.4 μ m	5mm	25mm
4700-125	125mm	2.5 μ m	6mm	30mm
4700-150	150mm	2.6 μ m	6mm	30mm
4700-200	200mm	2.8 μ m	6mm	30mm
4700-250	250mm	3.0 μ m	8mm	40mm
4700-300	300mm	3.2 μ m	8mm	40mm
4700-400	400mm	3.6 μ m	10mm	50mm
4700-500	500mm	4.0 μ m	10mm	50mm

SQUARE SET

- Includes:
 - 90° tool maker square 25x20mm DIN875 grade 00 (code **4794-025**)
 - 90° tool maker square 40x28mm DIN875 grade 00 (code **4794-040**)
 - 90° beveled edge square 75x50mm DIN875 grade 00 (code **4790-075**)
 - straight edge 100mm DIN874 (code **4700-100**)
 - scriber
- Made of hardened stainless steel

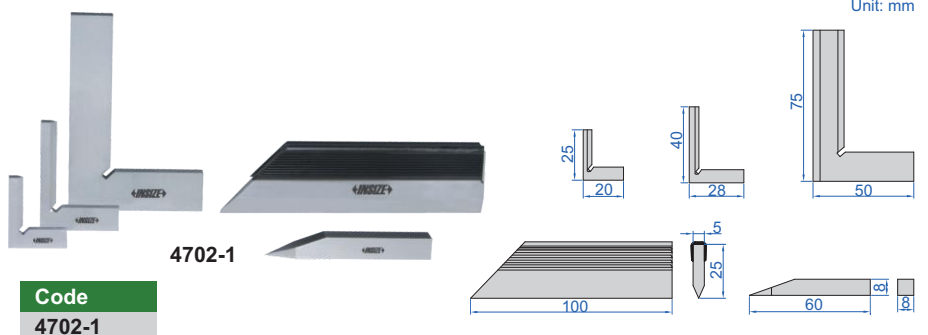

Code

4702-1

GRANITE STRAIGHT EDGES

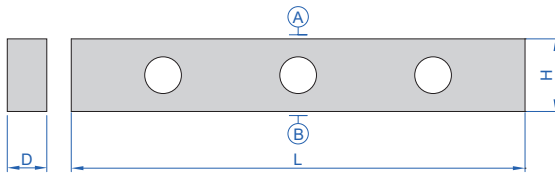

4147-500A

Code	Length (L)	Flatness of A and B	Parallelism between A and B	D	H
4147-500A	500mm	2.1µm	3.2µm	50mm	80mm
4147-1000A	1000mm	3.0µm	4.5µm	60mm	120mm

LIGHT WEIGHT

MAGNALIUM STRAIGHT EDGES

- Made of magnalium, light weight, non-deform, no rusty



4180-1500

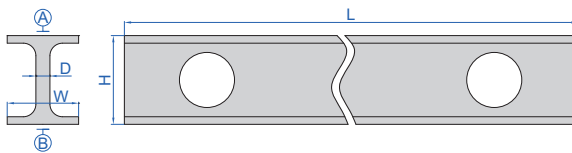

Code	Length (L)	Flatness of A and B	Parallelism between A and B	H	W	D	Weight
4180-500	500mm	3µm	4µm	60mm	30mm	5mm	1kg
4180-1000	1000mm	5µm	8µm	60mm	30mm	5mm	1.5kg
4180-1500	1500mm	15µm	22µm	100mm	40mm	7mm	4.5kg
4180-2000	2000mm	18µm	27µm	100mm	40mm	7mm	6kg
4180-2500	2500mm	22µm	33µm	100mm	40mm	7mm	7.5kg
4180-3000	3000mm	48µm	72µm	150mm	80mm	8mm	21kg

PRECISION STRAIGHT EDGES



7117-300

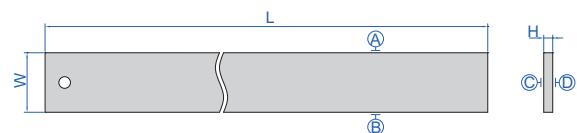

- Check flatness and for marking
- Made of tool steel

Code	Range (L)	Flatness of A and B	Flatness of C and D	W	H
7117-300	305mm	0.005mm	0.05mm	41mm	6.3mm
7117-600	610mm	0.006mm	0.06mm	51mm	7.9mm
7117-900	914mm	0.007mm	0.06mm	64mm	9.5mm

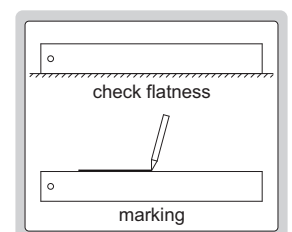

PRECISION STRAIGHT EDGES WITH BEVELED EDGE



7118-300

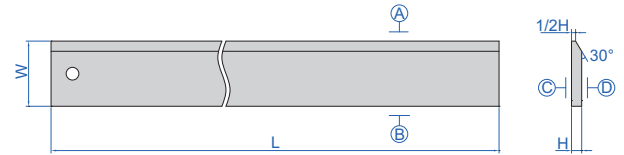

- Check flatness and for marking
- Made of tool steel

Code	Range (L)	Flatness of A and B	Flatness of C and D	W	H
7118-300	305mm	0.005mm	0.05mm	41mm	6.3mm
7118-600	610mm	0.006mm	0.06mm	51mm	7.9mm
7118-900	914mm	0.007mm	0.06mm	64mm	9.5mm

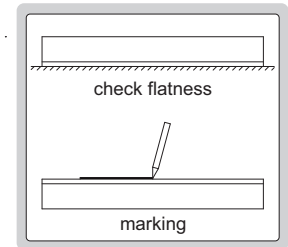

STRAIGHT EDGES



7111-300A

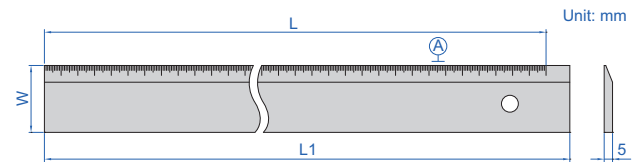

- Check flatness and straightness, as well as for marking
- Graduation on the beveled edge
- Made of hardened tool steel
- Chrome plated
- Graduation: 1mm

Code	Range (L)	Straightness of A	L1	W
7111-300A	300mm	0.02mm	310mm	40mm
7111-500A	500mm	0.03mm	510mm	40mm
7111-1000A	1000mm	0.04mm	1010mm	50mm

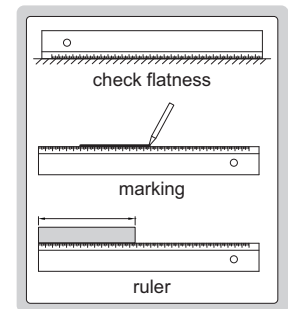

13

OPTICAL FLATS



4191-45B

- Check flatness
- Single working face, the arrow indicates the working face

CAN BE CUSTOM-MADE



VIDEO

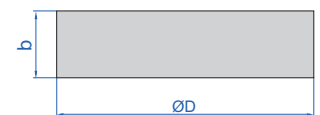

Code	b	ØD	Flatness
4191-45A	12mm	45mm	0.03µm
4191-60A	15mm	60mm	0.03µm

Code	b	ØD	Flatness
4191-45B	12mm	45mm	0.1µm
4191-60B	15mm	60mm	0.1µm



GRANITE HOLDER CAN BE CUSTOMIZED ACCORDING TO WORKPIECES

DATA OUTPUT

STRAIGHTNESS/FLATNESS GAUGE

- Optional accessory: wireless transmitter code **7315-50M** (receiver is needed) page 6, bluetooth transmitter code **7214-50M** page 12, data output cable code **7302-40M** page 21

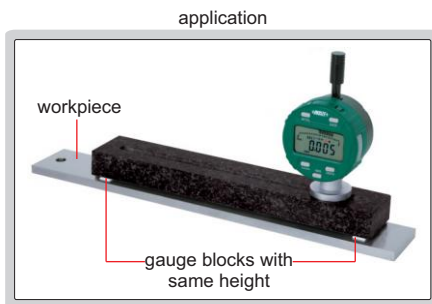

Code	Range	Digital indicator resolution	Straightness measurement accuracy	Parallelism of top and bottom surfaces of granite holder	Flatness of top and bottom surfaces of granite holder
2144-200	200mm	0.001mm/0.00005"	3µm	2µm	1.5µm



GRANITE PLATE CAN BE CUSTOMIZED ACCORDING TO WORKPIECES

DATA OUTPUT

FLATNESS MEASUREMENT STANDS

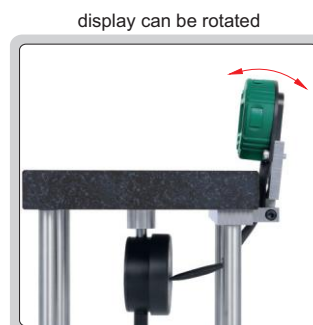
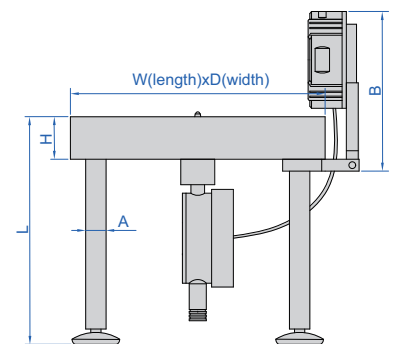

- Digital indicator resolution: 0.001mm/0.00005"
- Optional accessory: wireless transmitter code **7315-50M** (receiver is needed) page 6, bluetooth transmitter code **7214-50M** page 12, data output cable code **7302-40M** page 21, **7305-40M** page 17

(mm)

Code	Flatness measurement accuracy	Flatness of granite plate	W	D	H	L	A	B	Remark
6852-150	2µm	2µm	150	150	25	135	Ø12	100	non-waterproof digital indicator
6852-300	2µm	2µm	300	300	50	210	Ø20	135	non-waterproof digital indicator
6852-300WP	2µm	2µm	300	300	50	210	Ø20	135	IP65 waterproof digital indicator

14

CONCENTRICITY AND RUNOUT TESTERS

←INSIZE→



Concentricity Gauges
Page 428-432

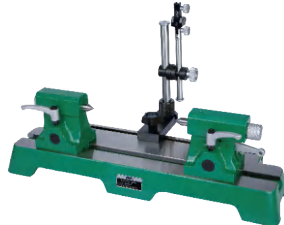

Bench Centers
Page 433-440



V-blocks
Page 441



Expansion Mandrels
Page 441

CONCENTRICITY GAUGES



HIGH STABILITY,
LONG WORKING LIFE

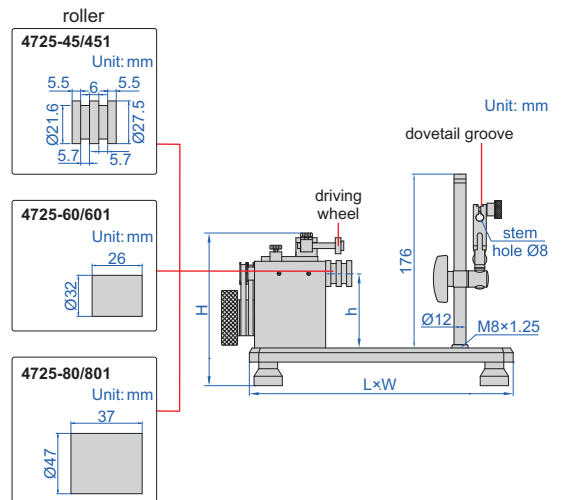
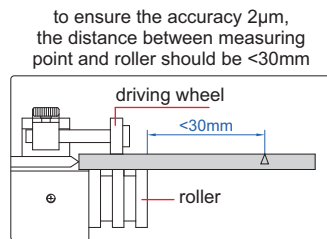
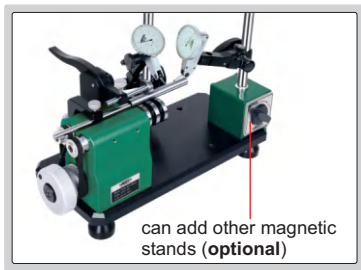
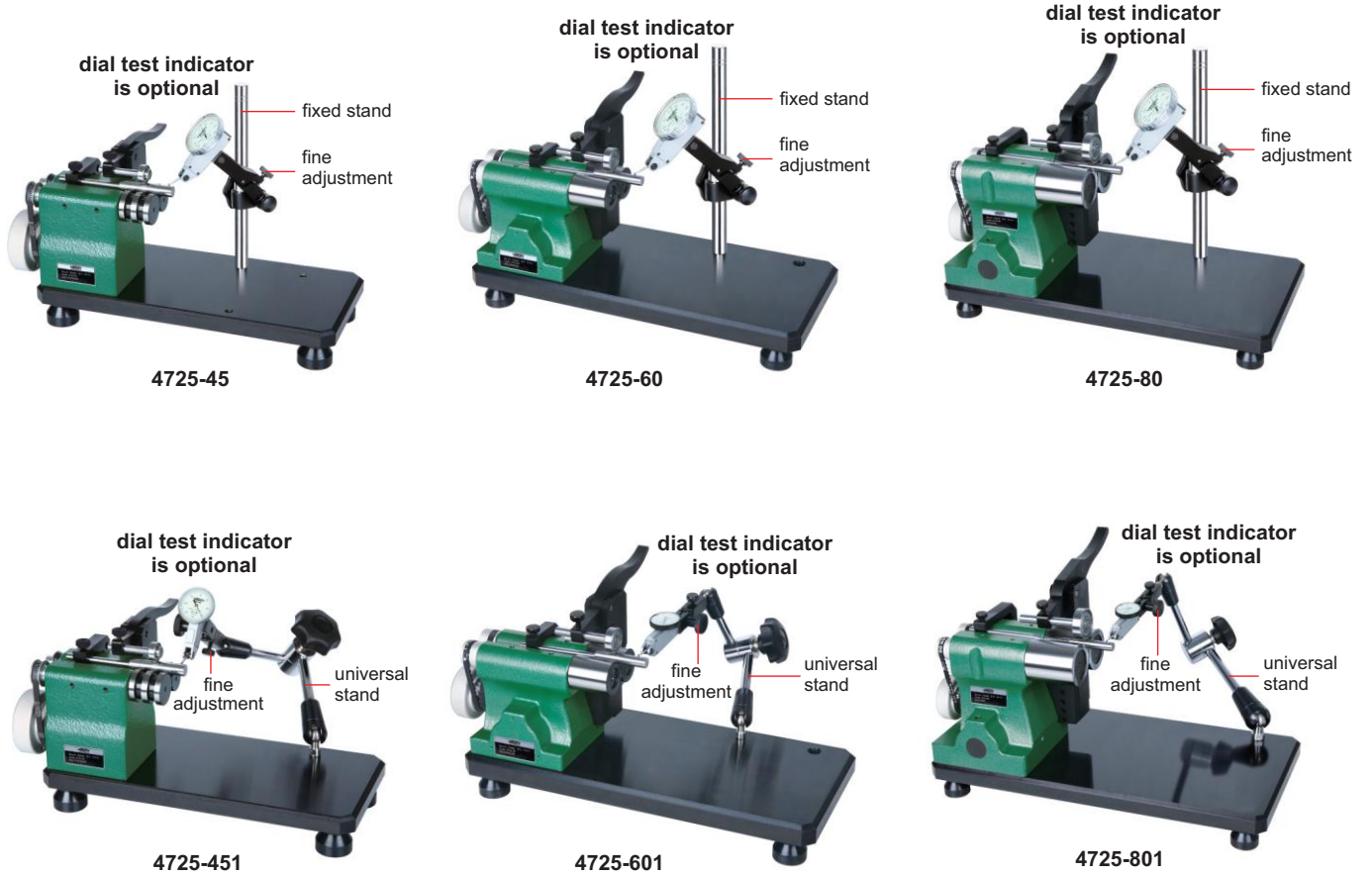

- With ball bearing, high stability, long working life
- Accuracy: 2 μ m
- Optional accessory: dial test indicator

Code	Diameter range	Center height (h)	L×W×H	Weight	Remark
4725-45	Ø3-45mm	80mm	280×130×170mm	6kg	fixed stand, high accuracy, inconvenient operation
4725-60	Ø8-60mm	90mm	350×160×190mm	15.6kg	fixed stand, high accuracy, inconvenient operation
4725-80	Ø8-80mm	130mm	400×200×250mm	25kg	fixed stand, high accuracy, inconvenient operation
4725-451	Ø3-45mm	80mm	280×130×170mm	6kg	universal stand, low accuracy, convenient operation
4725-601	Ø8-60mm	90mm	350×160×190mm	15.6kg	universal stand, low accuracy, convenient operation
4725-801	Ø8-80mm	130mm	400×200×250mm	25kg	universal stand, low accuracy, convenient operation

CONCENTRICITY GAUGES

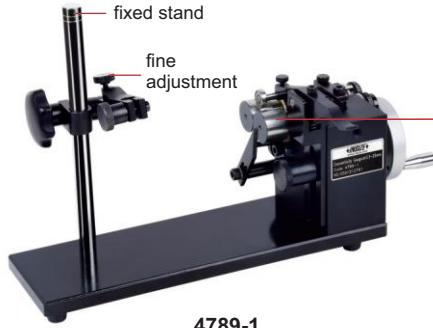

4789-1

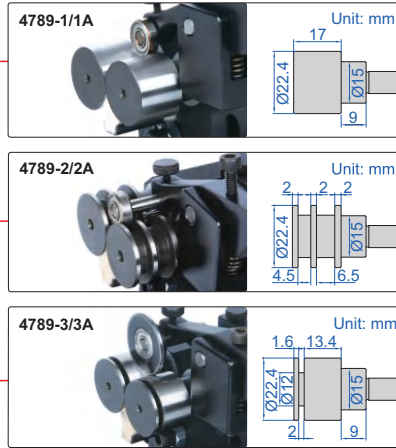

4789-2A

to ensure the accuracy 2 μ m, the distance between measuring point and roller should be <30mm

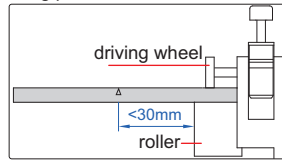

- Accuracy 2 μ m
- Optional accessory: dial test indicator

Code	Applicable diameter	Remark
4789-1	Ø3.5mm-25mm	fixed stand, high accuracy, inconvenient operation
4789-2	Ø1mm-25mm	fixed stand, high accuracy, inconvenient operation
4789-3	Ø1mm-25mm	fixed stand, high accuracy, inconvenient operation
4789-1A	Ø3.5mm-25mm	universal stand, low accuracy, convenient operation
4789-2A	Ø1mm-25mm	universal stand, low accuracy, convenient operation
4789-3A	Ø1mm-25mm	universal stand, low accuracy, convenient operation

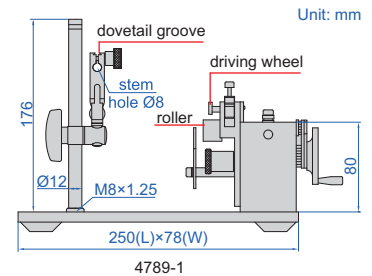

CONCENTRICITY GAUGES

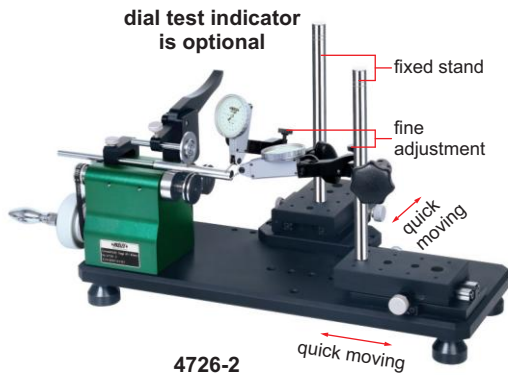

4726-2

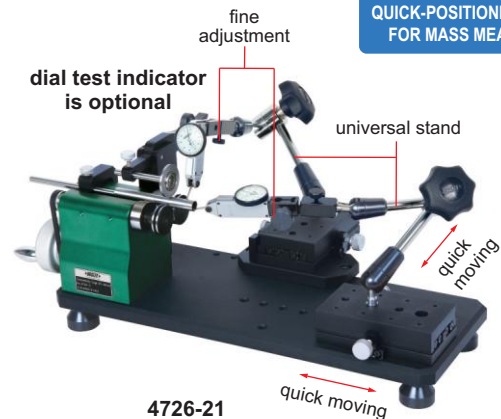

4726-21

QUICK-POSITIONING, SUITABLE FOR MASS MEASUREMENT

to ensure the accuracy 2 μ m, the distance between measuring point and roller should be <30mm

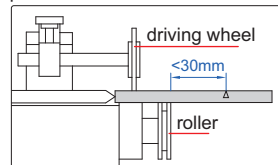

- With ball bearing, high stability, long working life
- Accuracy: 2 μ m
- Optional accessory: dial test indicator

Code	Applicable diameter	Remark
4726-1	Ø4-40mm	fixed stand, high accuracy, inconvenient operation
4726-2	Ø2-40mm	fixed stand, high accuracy, inconvenient operation
4726-11	Ø4-40mm	universal stand, low accuracy, convenient operation
4726-21	Ø2-40mm	universal stand, low accuracy, convenient operation

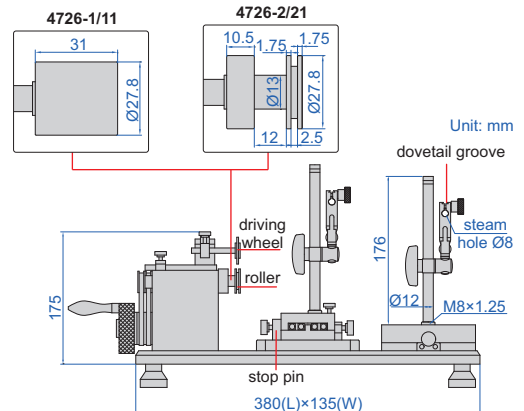

QUICK-POSITIONING, SUITABLE FOR MASS MEASUREMENT

QUICK POSITIONING CONCENTRICITY GAUGES

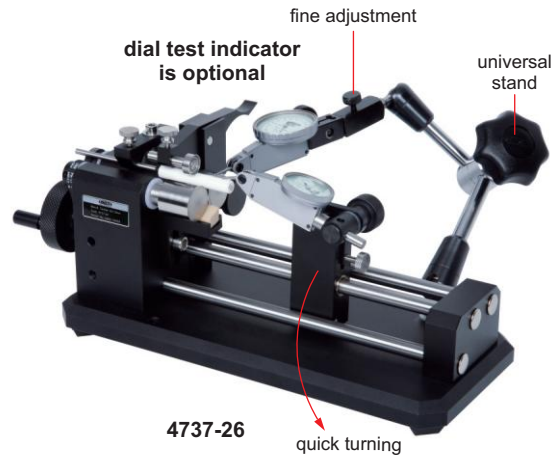
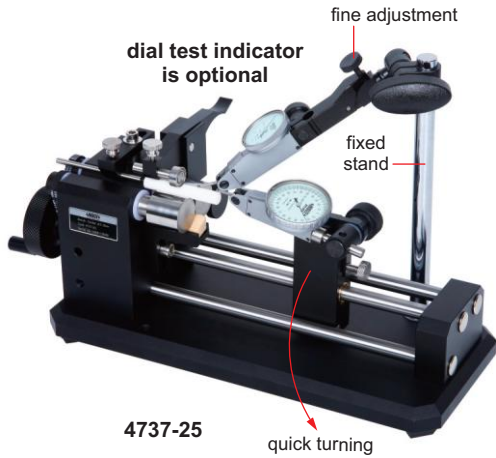

standard rod (included)



to ensure the accuracy 2 μ m, the distance between measuring point and roller should be <30mm

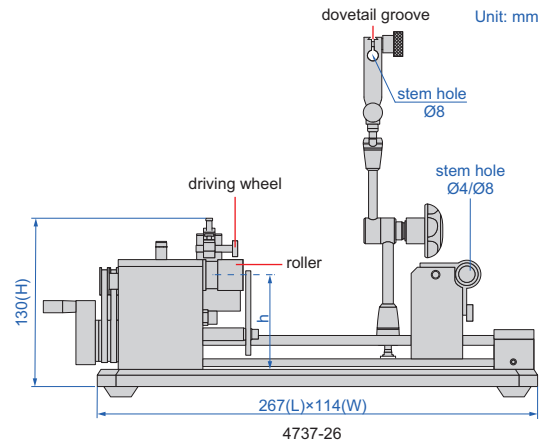
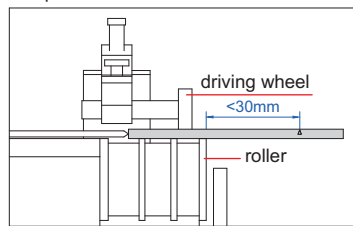

- Quick positioning, suitable for mass measurement
- Supplied with standard rod to verify accuracy
- Optional accessory: dial test indicators

Code	Diameter range	Workpiece length	Accuracy	Center height (h)	L×W×H	Weight	Remark
4737-25	Ø3-25mm	15-100mm	2 μ m	70mm	267×114×130mm	3kg	fixed stand, high accuracy, inconvenient operation
4737-26	Ø3-25mm	15-100mm	2 μ m	70mm	267×114×130mm	3kg	universal stand, low accuracy, convenient operation

QUICK POSITIONING CONCENTRICITY GAUGE

QUICK-POSITIONING, SUITABLE FOR MASS MEASUREMENT

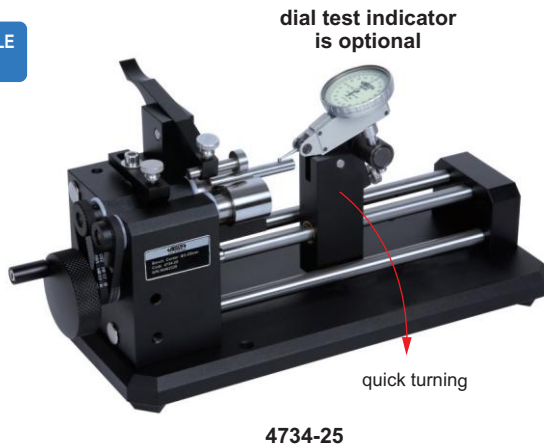

to ensure the accuracy 2µm, the distance between measuring point and roller should be <30mm

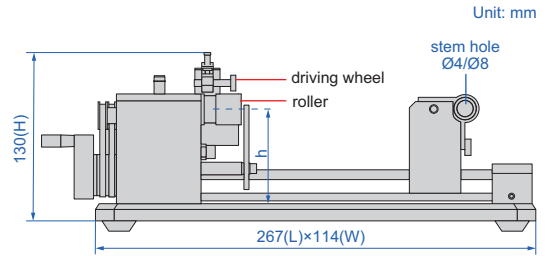
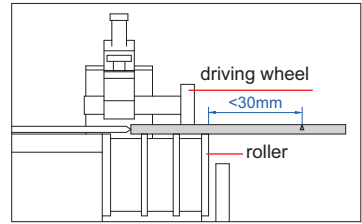

- Quick positioning, suitable for mass measurement
- Optional accessory: dial test indicators

Code	Diameter range	Workpiece length	Accuracy	Center height (h)	L×W×H	Weight
4734-25	Ø3-25mm	15-100mm	2µm	70mm	267×114×130mm	3kg

CONCENTRICITY GAUGES

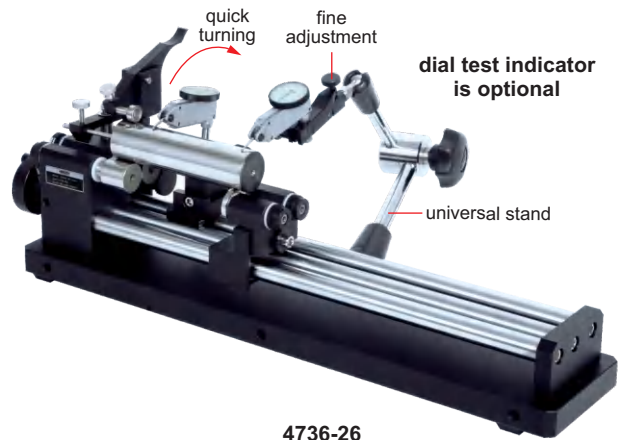

standard rod (included)

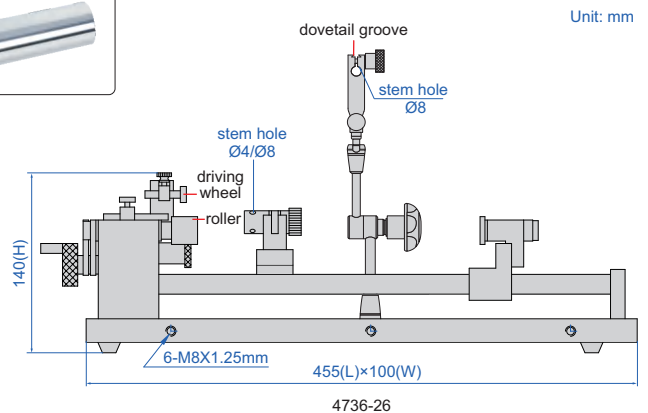
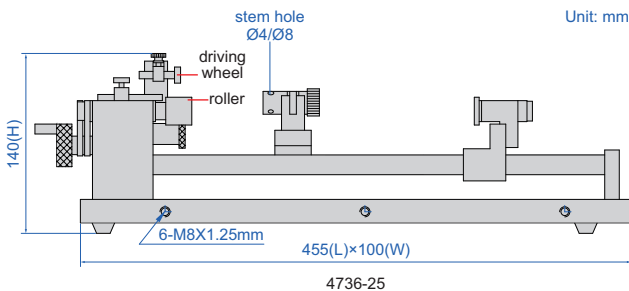

- Quick positioning, suitable for mass measurement
- Supplied with standard rod to verify accuracy
- Optional accessory: dial test indicators

Code	Diameter range	Workpiece length	Accuracy	L×W×H	Weight	Remark
4736-25	Ø3-25mm	15-305mm	2µm	455×100×140mm	6kg	without universal stand
4736-26	Ø3-25mm	15-305mm	2µm	455×100×140mm	6.5kg	with universal stand

CONCENTRICITY GAUGE WITH STRAIGHTNESS MEASUREMENT

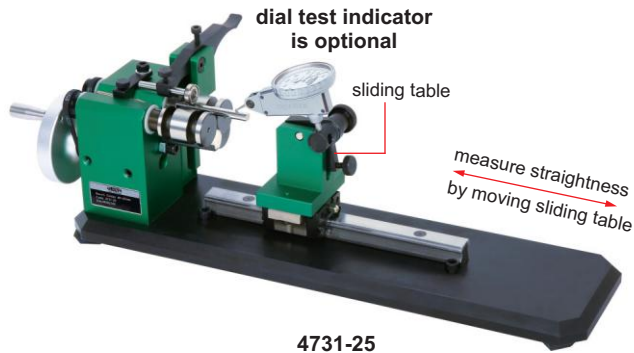

4731-25

- Maximum moving range of sliding table: 120mm
- Optional accessory: dial test indicator

to ensure the accuracy 2 μ m, the distance between measuring point and roller should be <30mm

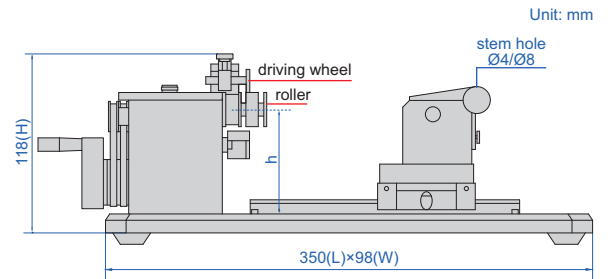
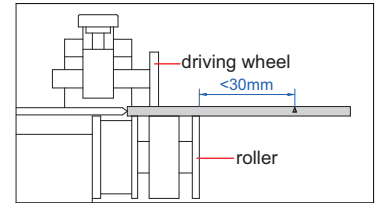

Unit: mm

Code	Diameter range	Workpiece length	Roller concentricity accuracy	Straightness measurement accuracy	Center height (h)	L×W×H	Weight
4731-25	Ø1-25mm	15-80mm	2 μ m	0.01mm	70mm	350×98×118mm	5.3kg



CONCENTRICITY GAUGES

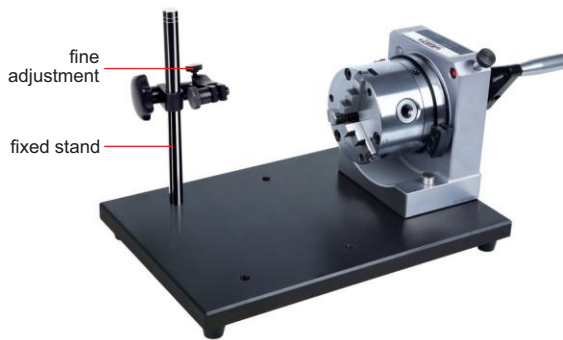

4786-1

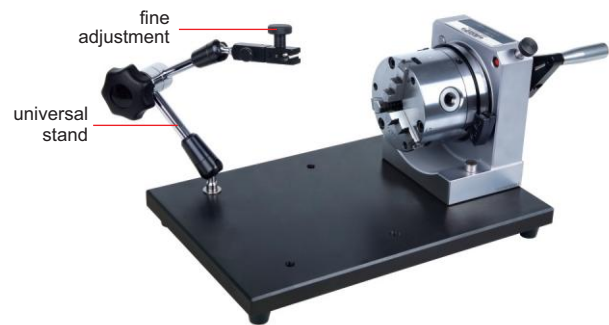

4786-2

- Accuracy: 3 μ m
- Ø50mm setting ring and Ø55mm calibration cylinder are included
- Optional accessory: dial test indicator

for cylinder



for tube



to ensure the accuracy 3 μ m, the distance between measuring point and roller should be <50mm

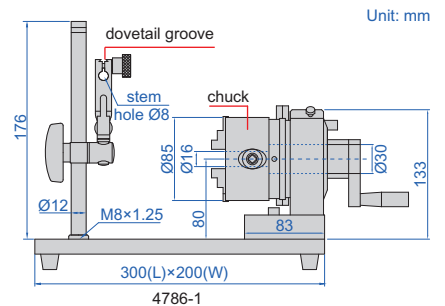
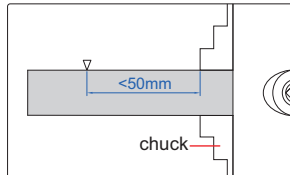

Unit: mm

4786-1

Code	Applicable inside diameter	Applicable outside diameter	Remark
4786-1	Ø24-64mm	Ø2-70mm	fixed stand, high accuracy, inconvenient operation
4786-2	Ø24-64mm	Ø2-70mm	universal stand, low accuracy, convenient operation

BENCH CENTERS



POPULAR MODEL

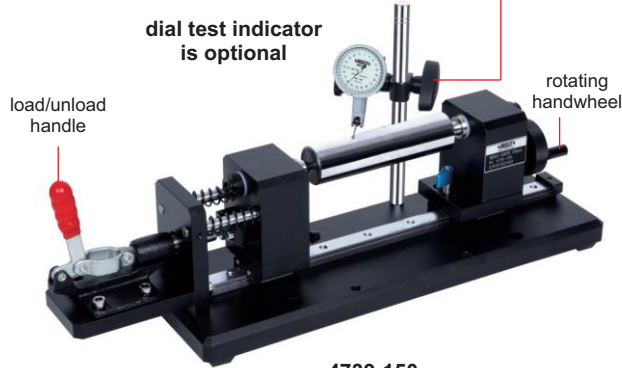
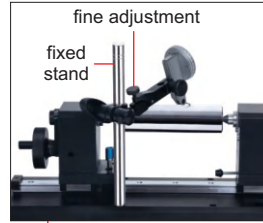

4739-150

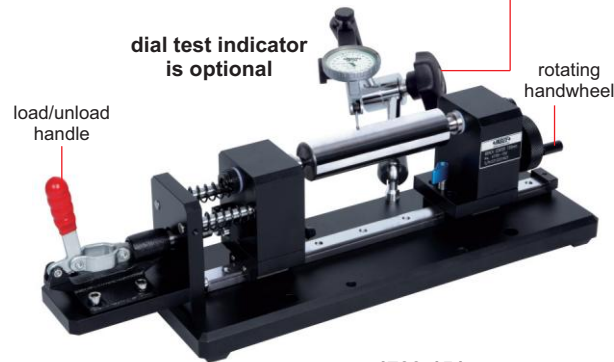
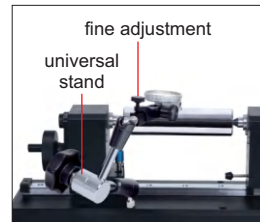

4739-151

standard rod (included)



- Quick positioning, suitable for mass measurement
- Suitable for cylinders with outside diameter $\varnothing 3-140\text{mm}$ or inside diameter $\varnothing 1-12\text{mm}$
- Supplied with standard rod to verify accuracy
- Optional accessory: dial test indicators

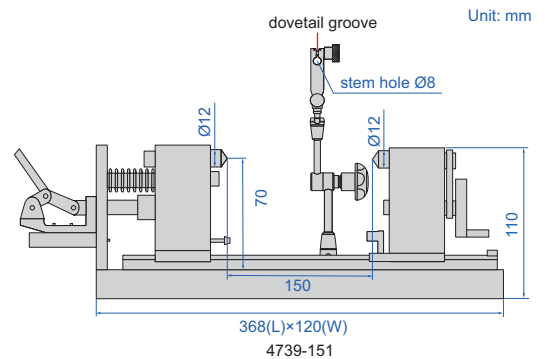

Code	Center height	Distance between two centers	Runout accuracy	Weight	Load	Remark
4739-150	70mm	150mm	2 μm	6.5kg	15kg	fixed stand, high accuracy, inconvenient operation
4739-151	70mm	150mm	2 μm	6.5kg	15kg	universal stand, low accuracy, convenient operation

BENCH CENTERS

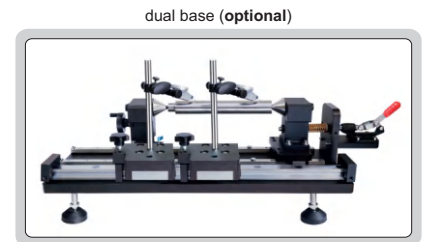
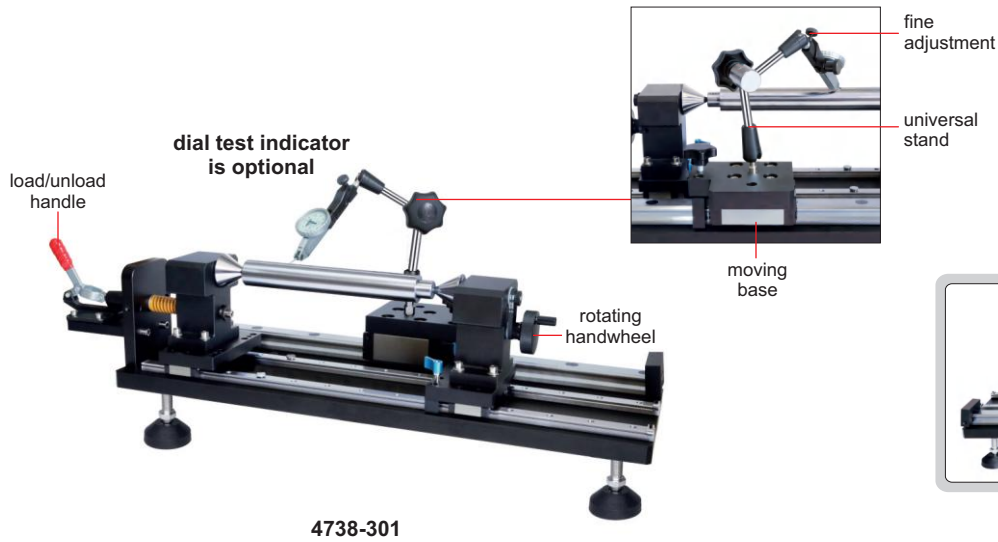
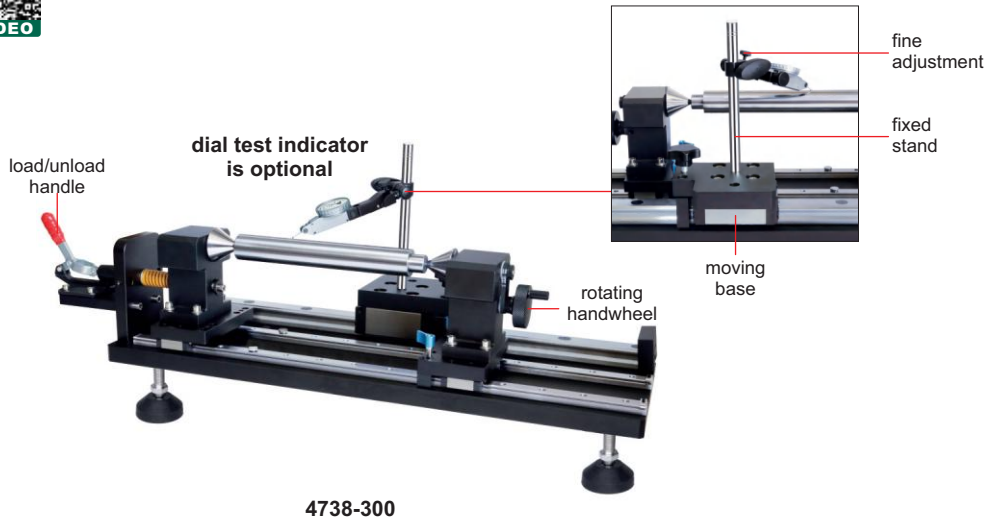

- Quick positioning, suitable for mass measurement
- Suitable for cylinders with outside diameter $\varnothing 3-180\text{mm}$ or inside diameter $\varnothing 1-40\text{mm}$
- Supplied with standard rod to verify accuracy
- Optional accessory: dial test indicators

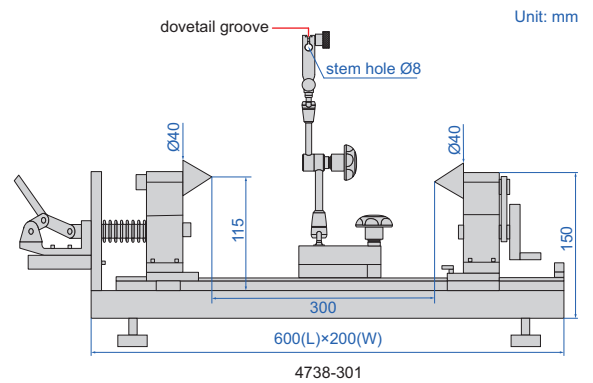

Code	Center height	Distance between two centers	Runout accuracy	Weight	Load	Remark
4738-300	90mm	300mm	2 μm	15kg	20kg	fixed stand, high accuracy, inconvenient operation
4738-301	90mm	300mm	2 μm	15kg	20kg	universal stand, low accuracy, convenient operation

BENCH CENTERS

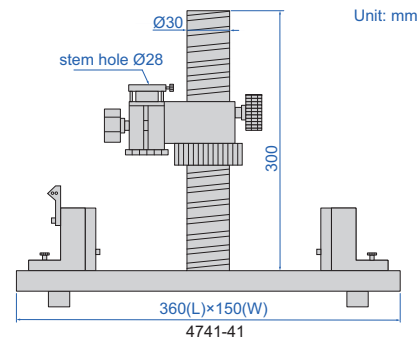
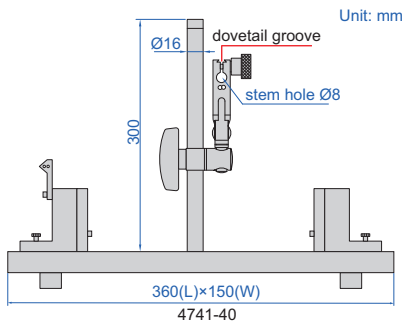
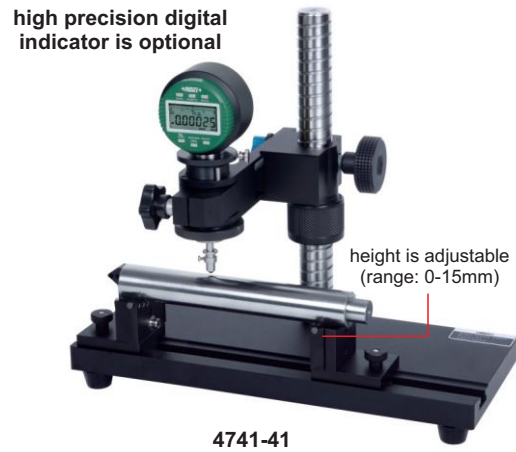
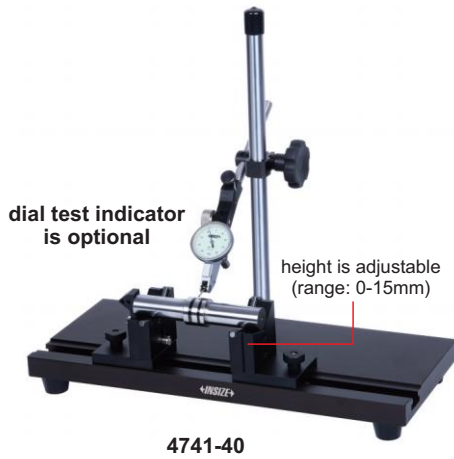

- Quick positioning, suitable for mass measurement
- 4741-40 optional accessory: dial test indicators (code 2880-02, 2880-02R)
- 4741-41 optional accessory: high precision digital indicators (code 2140-6, 2140-6WL)

Code	Stem hole	Diameter range	Workpiece length	Accuracy
4741-40	Ø8mm	Ø3-40mm	15-300mm	2µm
4741-41	Ø28mm	Ø3-40mm	15-300mm	2µm

BENCH CENTER (BASIC TYPE)



14

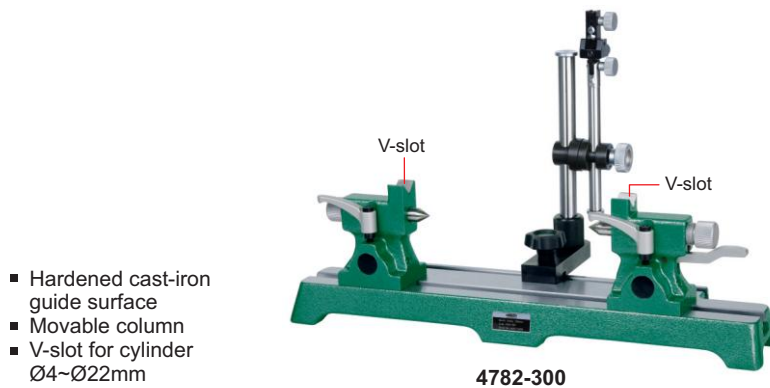

- Hardened cast-iron guide surface
- Movable column
- V-slot for cylinder Ø4~Ø22mm

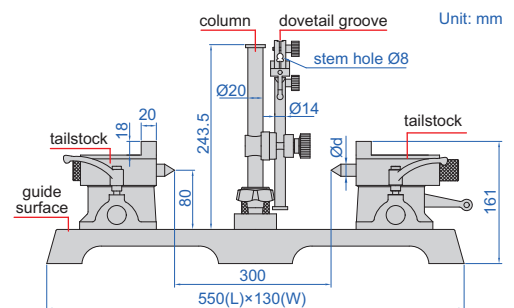

Code	Parallelism*	Runout accuracy	Center height	Distance between two centers	Diameter of center (Ød)	Load
4782-300	0.01mm	2µm	80mm	300mm	Ø16mm	25kg

*Parallelism of two centers to the guide surface

BENCH CENTERS

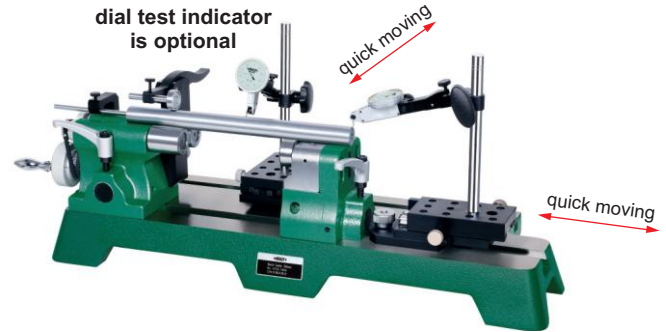
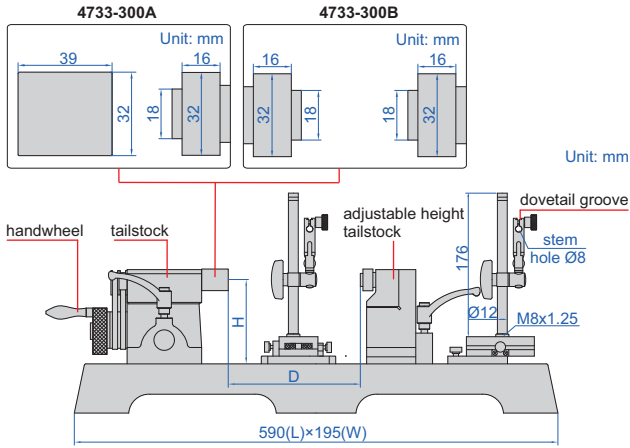

4733-300A

- Hardened cast-iron guide surface
- Quick moving is suitable for mass production inspection
- Adjustable height tailstock: 0-15mm, suitable for inspecting workpieces with different diameters
- Optional accessory: dial test indicator

Code	Runout accuracy	Center height (H)	Distance between two centers (D)	Applicable diameter	Adjustable height	Remarks
4733-300A	2µm	90mm	300mm	Ø8-60mm	0-15mm	with handwheel
4733-300B	2µm	90mm	300mm	Ø8-60mm	0-15mm	without handwheel



BENCH CENTER WITH STRAIGHTNESS MEASUREMENT

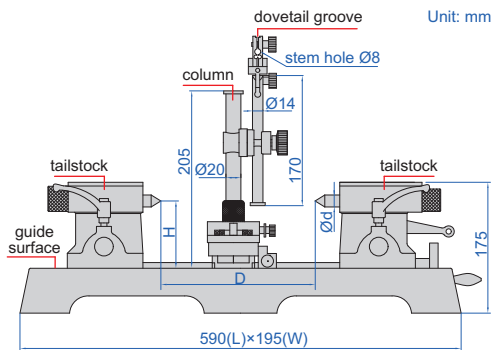

4723-300

straightness measurement

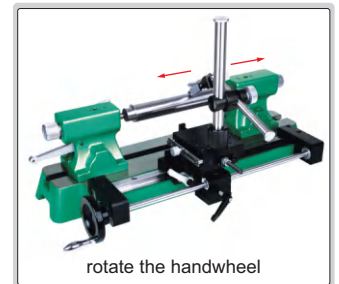

- Hardened cast-iron guide surface

Code	Parallelism*	Runout accuracy	Accuracy of straightness measurement	Center height (H)	Distance between two centers (D)	Diameter of center (Ød)	Taper of center	Weight	Load
4723-300	4µm	2µm	0.02mm	90mm	300mm	18mm	MT2	38kg	25kg

*Parallelism of two centers to the guide surface

BENCH CENTERS

Unit: mm

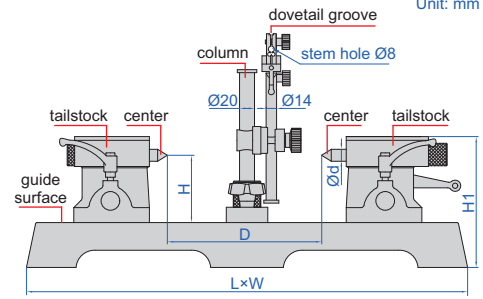
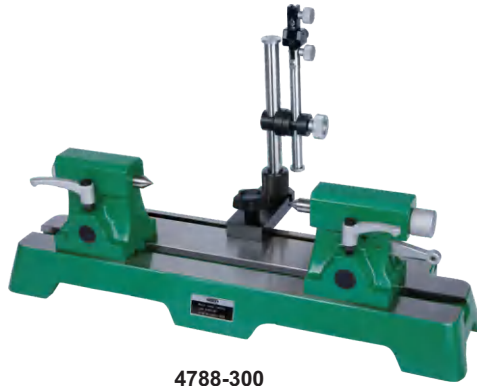

- Movable column
- Optional accessory: umbrella centers, rotary centers

4788-300

High accuracy

(mm)

Code	Parallelism*	Runout accuracy	Center height (H)	Distance between two centers (D)	L	W	H1	Diameter of center (Ød)	Taper of center	Weight	Load
4788-300	0.010mm	2µm	90	300	590	192	175	18.0	MT2	34kg	25kg
4788-400	0.010mm	2µm	130	400	770	206	241	24.1	MT3	66kg	60kg
4788-600	0.010mm	2µm	130	600	930	220	250	24.1	MT3	90kg	60kg
4788-600H2	0.010mm	2µm	200	600	930	220	325	24.1	MT3	105kg	60kg
4788-1000	0.010mm	3µm	130	1000	1330	220	262	24.1	MT3	112kg	60kg
4788-1000H2	0.010mm	3µm	200	1000	1330	220	337	24.1	MT3	125kg	85kg
4788-1000H3	0.010mm	3µm	300	1000	1330	220	442	31.6	MT4	165kg	85kg

Standard accuracy

(mm)

Code	Parallelism*	Runout accuracy	Center height (H)	Distance between two centers (D)	L	W	H1	Diameter of center (Ød)	Taper of center	Weight	Load
4788-D2	0.010mm	3µm	90	200	490	180	175	20.0	MT2	27kg	25kg
4788-D3	0.010mm	3µm	90	300	590	195	175	20.0	MT2	36kg	25kg
4788-D4	0.012mm	3µm	130	400	730	205	241	28.0	MT3	68kg	60kg
4788-D6	0.015mm	3µm	130	600	930	220	250	28.0	MT3	91kg	60kg
4788-D8	0.015mm	3µm	130	800	1130	220	250	28.0	MT3	99kg	60kg
4788-D10	0.015mm	3µm	130	1000	1330	220	262	28.0	MT3	116kg	60kg

*Parallelism of two centers to the guide surface

DEAD CENTERS

14

- Supplied in pair
- Suitable for 4723 and 4788 series bench centers

Code	Taper of handle
6391-MT2	MT2
6391-MT3	MT3

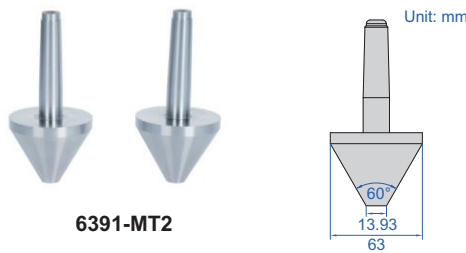

6391-MT2

Unit: mm

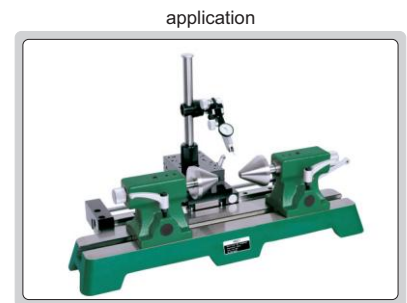

ROTARY CENTERS

- Supplied in pair
- Carbide tip
- Rotational repeatability 0.005mm
- Suitable for 4723 and 4788 series bench centers

ACTIVE CENTER DIAMETER A CAN BE CUSTOMIZED RANGE (MT2: 25-40mm, MT3: 38-55mm, MT4: 38-70mm)

(mm)

Code	Taper of handle	A	B	C
6392-MT2	MT2	Ø25	Ø38	Ø18
6392-MT3	MT3	Ø38	Ø45	Ø24.1
6392-MT4	MT4	Ø38	Ø45	Ø31.6



6392-MT2

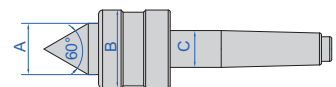

BENCH CENTER WITH ROLLER TAILSTOCKS

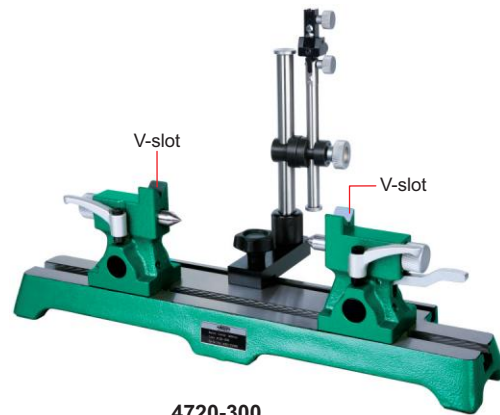
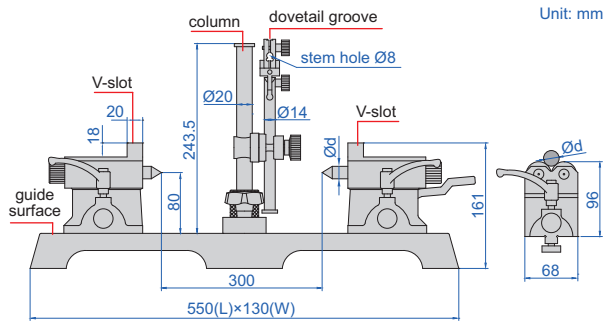

4720-300

- Hardened cast-iron guide surface
- Supplied with V-slot/center tailstocks and roller tailstocks
- V-slot for cylinder Ø4~22mm
- Roller for cylinder Ø5~100mm



Code	Parallelism*	Runout accuracy	Center height	Distance between two centers	Diameter of center (Ød)	Taper of center	Load
4720-300	0.01mm	2µm	80mm	300mm	16mm	MT1	25kg (40kg for roller tailstocks)

*Parallelism of two centers to the guide surface



MOTORIZED BENCH CENTER

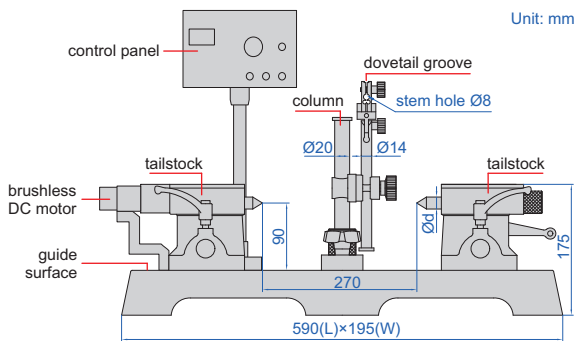

4735-270

- Moveable column
- Hardened cast-iron guide surface
- Motorized measurement is suitable for mass production inspection
- Power supply: AC220V/10A/(50/60)Hz
- Optional accessory: dial test indicators

Code	Parallelism*	Runout accuracy	Center height	Distance between two centers	Diameter of center (Ød)	Taper of center	Weight	Load
4735-270	0.010mm	2µm	90mm	270mm	18mm	MT2	40kg	25kg

*Parallelism of two centers to the guide surface

VERTICAL BENCH CENTER

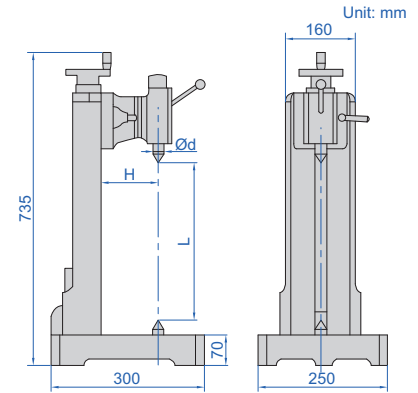
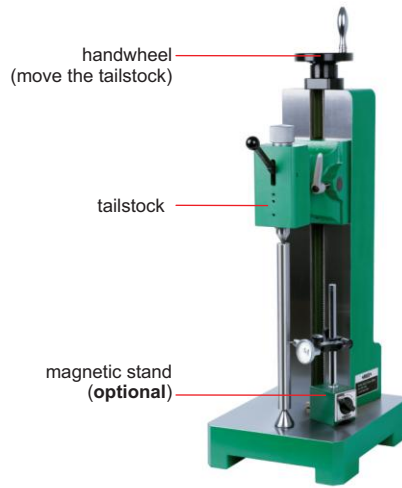

4728-360

- Distance between two centers (L): 360mm
- Hardened cast-iron guide surface
- Use handwheel to move the tailstock
- Optional accessory: magnetic stands, dial test indicator

Code	Parallelism*	Runout accuracy	Center height (H)	Diameter of center (Ød)	Taper of center	Weight	Load
4728-360	0.01mm	2µm	130mm	24.1mm	MT3	85kg	80kg

*Parallelism of two centers to the guide surface

VERTICAL AND HORIZONTAL BENCH CENTER



vertical use



horizontal use

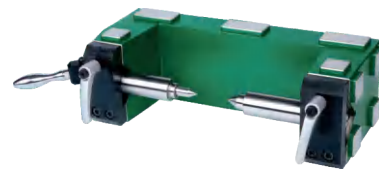

side use

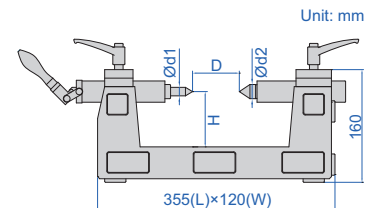

- For vertical, side and horizontal use

Code	Runout accuracy	Center height (H)	Distance between two centers (D)	Diameter of center (Ød1/Ød2)	Weight	Load
4722-200	2µm	80mm	200mm	16mm/20.2mm	22kg	25kg

MINI BENCH CENTER



4721-75A

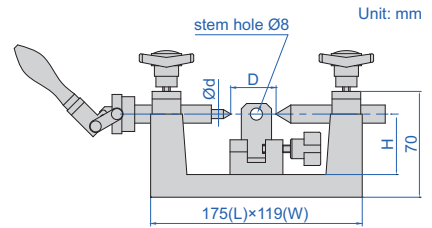

Code	Runout accuracy	Center height (H)	Distance between two centers (D)	Diameter of center (Ød)	Taper of center	Weight	Load
4721-75A	2µm	40mm	35-100mm	6mm	MT1	4.5kg	4kg



CAN BE CUSTOMIZED

TAPER INSPECTION INSTRUMENTS

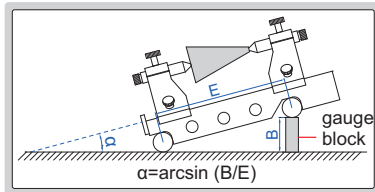

4157-200

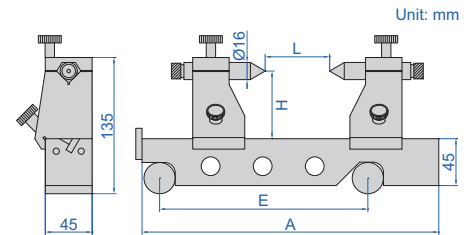

- Check the taper angle of taper bar/taper plug gauges /Morse taper/ISO taper etc. The run out can be checked as well

Code	Center height (H)	Center distance (L)	Sine bar accuracy (when α=30°)	E	A
4157-200	65mm	200mm	±5 seconds	200mm	285mm
4157-300	65mm	300mm	±8 seconds	300mm	385mm

REFER TO PAGE 498 FOR DETAILS

MAGNETIC SQUARE WITH V GROOVE



6539-100

V-BLOCKS

REFER TO PAGE
491-498 FOR DETAILS



6896-11



6887-3



6897-1



6890-702



6888-1

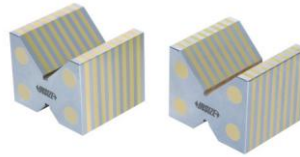

6878-1



6891-1

EXPANSION MANDRELS

CUSTOMIZED HIGH PRECISION MANDREL
WITH 3µm RADIAL RUNOUT IS AVAILABLE



6335-3A

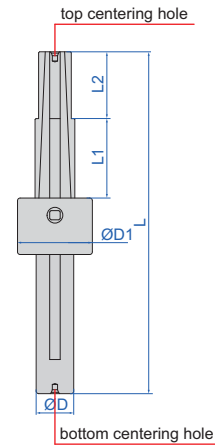

14

- Checking runout of gears with the bore as a reference
- With centering holes on top and bottom ends, it can rotate between two centers for easy measurement
- Radial runout: 5µm

Code	Bore clamping range	L	L1	L2	ØD	ØD1
6335-0A	Ø9.53-12.70mm	121.9	12.7	12.7	14.7	38.1
6335-1A	Ø12.70-19.05mm	147.7	24.9	24.9	14.7	38.1
6335-2A	Ø19.05-25.40mm	147.7	24.9	24.9	14.7	38.1
6335-3A	Ø25.40-38.10mm	260.4	60.5	50.3	28.6	57.2
6335-4A	Ø38.10-50.80mm	308.0	75.7	66.0	36.5	76.2
6335-5A	Ø50.80-63.50mm	308.0	75.7	66.0	36.5	76.2
6335-6A	Ø63.50-76.20mm	308.0	72.4	66.0	36.5	76.2
6335-7A	Ø50.80-76.20mm	425.5	90.2	89.9	50.4	95.3
6335-8A	Ø76.20-101.60mm	425.5	83.3	89.9	50.4	95.3
6335-9A	Ø101.60-127.00mm	425.5	83.3	89.9	50.4	95.3
6335-10A	Ø127.00-152.40mm	425.5	83.3	89.9	50.4	95.3
6335-11A	Ø152.40-177.80mm	425.5	83.3	89.9	50.4	95.3

application







Feeler Gauges
Page 445-448



Pitch Gauges
Page 449



Gear Tooth Pitch Gauges
Page 450



Center Gauges
Page 450



Thread Gauges
Page 450



Angle Gauges
Page 451



Radius Gauges
Page 451-452



Drill Gauges
Page 453



Angle Gauges
Page 453



Wire Gauges
Page 454



Thickness Gauges
Page 454-455



Taper Slot Gauges
Page 455-456



Taper Gauges
Page 456-457



Taper Bore Gauges
Page 458



Welding Gauges
Page 458-460



Fillet Welding Gauges
Page 461-462

15

SIMPLE MEASURING TOOLS



Welding Gauges
Page 462-463



Pipe Welding Gauges
Page 464

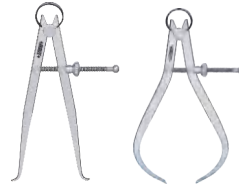

Inside/Outside Calipers
Page 466-467



Dividers
Page 467



Measuring Tapes
Page 468-471



Long Measuring Tapes
Page 471



Measuring Wheels
Page 471-472



Digital Measuring Wheels
Page 472



Steel Rulers
Page 472-473



Digital Scales With Microscope
Page 474



Combination Squares
Page 475-476



Plastic Angle Squares
Page 477



T-bevels
Page 477



Marking Gauges
Page 478



Center Marking Gauges
Page 478



Scribing Calipers
Page 479

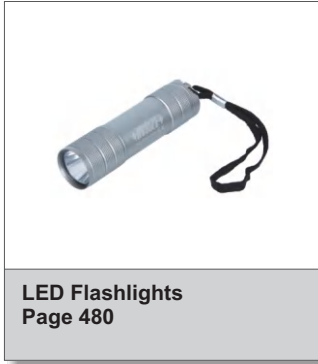
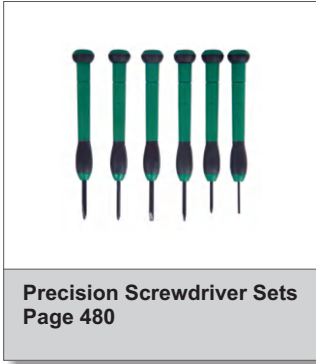
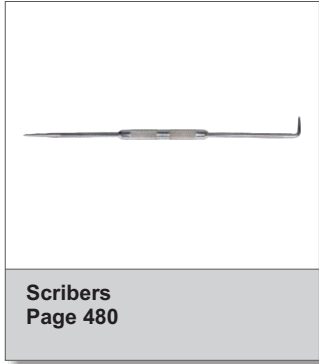
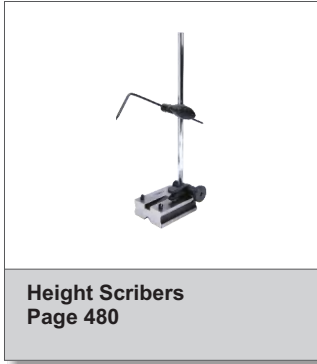

FEELER GAUGE



4601-25

- Made of hardened alloy steel
- Meet DIN2275/grade TC1
- Accuracy: $\pm(3+T/80)\mu\text{m}$,
'T' is the thickness of leaves in μm

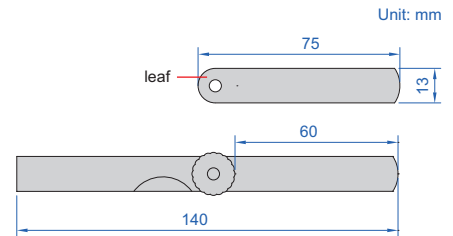

Code	Range	Thickness of leaves included (mm)	Quantity of leaves
4601-25	0.04-1.00mm	0.04, 0.05, 0.06, 0.07, 0.08, 0.09, 0.10, 0.15, 0.20, 0.25, 0.30, 0.35, 0.40, 0.45, 0.50, 0.55, 0.60, 0.65, 0.70, 0.75, 0.80, 0.85, 0.90, 0.95, 1.00	25

FEELER GAUGES

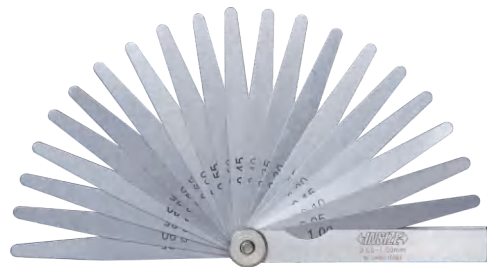

4602-20

- Made of hardened alloy steel
- Meet DIN2275/grade TC1
- Accuracy: $\pm(3+T/80)\mu\text{m}$,
'T' is the thickness of leaves in μm

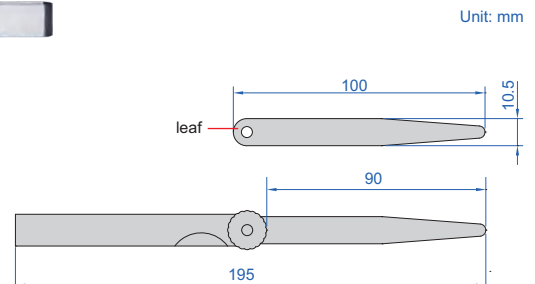

Code	Range	Thickness of leaves included (mm)	Quantity of leaves
4602-13A	0.03-0.50mm	0.03, 0.04, 0.05, 0.06, 0.07, 0.08, 0.09, 0.10, 0.15, 0.20, 0.30, 0.40, 0.50	13
4602-13	0.05-1.00mm	0.05, 0.10, 0.15, 0.20, 0.25, 0.30, 0.40, 0.50, 0.60, 0.70, 0.80, 0.90, 1.00	13
4602-17	0.02-1.00mm	0.02, 0.03, 0.04, 0.05, 0.06, 0.07, 0.08, 0.09, 0.10, 0.15, 0.20, 0.25, 0.30, 0.40, 0.50, 0.75, 1.00	17
4602-20	0.05-1.00mm	0.05, 0.10, 0.15, 0.20, 0.25, 0.30, 0.35, 0.40, 0.45, 0.50, 0.55, 0.60, 0.65, 0.70, 0.75, 0.80, 0.85, 0.90, 0.95, 1.00	20
4602-28	0.05-1.00mm	0.05, 0.06, 0.07, 0.08, 0.09, 0.10, 0.11, 0.12, 0.13, 0.14, 0.15, 0.20, 0.25, 0.30, 0.35, 0.40, 0.45, 0.50, 0.55, 0.60, 0.65, 0.70, 0.75, 0.80, 0.85, 0.90, 0.95, 1.00	28
4602-32	0.03-1.00mm	0.03, 0.04, 0.05, 0.06, 0.07, 0.08, 0.09, 0.10, 0.13, 0.15, 0.18, 0.20, 0.23, 0.25, 0.28, 0.30, 0.33, 0.35, 0.38, 0.40, 0.45, 0.50, 0.55, 0.60, 0.63, 0.65, 0.70, 0.75, 0.80, 0.85, 0.90, 1.00	32
4602-15	0.05-2.00mm	0.05, 0.10, 0.15, 0.20, 0.25, 0.30, 0.40, 0.50, 0.60, 0.70, 0.80, 0.90, 1.00, 1.50, 2.00	15

LONG FEELER GAUGES



4605-20

Unit: mm

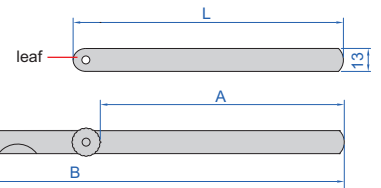

- Made of hardened alloy steel
- Meet DIN2275/grade TC1
- Accuracy: $\pm(3+T/80)\mu\text{m}$,
'T' is the thickness of leaves in μm

Code	Range	Thickness of leaves included (mm)	Quantity of leaves	L	A	B
4605-13	0.05-1.00mm	0.05, 0.10, 0.15, 0.20, 0.25, 0.30, 0.40, 0.50, 0.60, 0.70, 0.80, 0.90, 1.00	13	150mm	135mm	295mm
4605-131	0.05-1.00mm		13	200mm	185mm	395mm
4605-132	0.05-1.00mm		13	300mm	285mm	590mm
4605-20	0.05-1.00mm	0.05, 0.10, 0.15, 0.20, 0.25, 0.30, 0.35, 0.40, 0.45, 0.50, 0.55, 0.60, 0.65, 0.70, 0.75, 0.80, 0.85, 0.90, 0.95, 1.00	20	150mm	135mm	295mm
4605-201	0.05-1.00mm		20	200mm	185mm	395mm
4605-202	0.05-1.00mm		20	300mm	285mm	590mm

INCH FEELER GAUGE

- 0.010" is made of brass, others are made of hardened alloy steel
- Each blade is marked with inch/metric size



4608-31

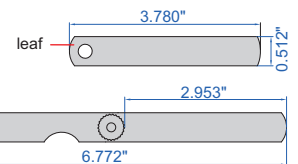

Code	Range	Quantity of Leaves
4608-31	0.0015"~0.035"	32

Thickness of leaves included	Accuracy
0.010" (brass)	$\pm 0.00039"$
0.0015", 0.002"	$\pm 0.0002"$
0.0025", 0.003", 0.004", 0.005", 0.006", 0.007"	$\pm 0.00028"$
0.008", 0.009"	$\pm 0.00035"$
0.010", 0.011"	$\pm 0.00039"$
0.012", 0.013"	$\pm 0.00047"$
0.014", 0.015"	$\pm 0.00051"$

Thickness of leaves included	Accuracy
0.016", 0.017"	$\pm 0.00055"$
0.018", 0.019"	$\pm 0.00059"$
0.020", 0.021"	$\pm 0.00067"$
0.022", 0.023"	$\pm 0.00071"$
0.024", 0.025", 0.026"	$\pm 0.00075"$
0.028"	$\pm 0.00091"$
0.030"	$\pm 0.00094"$
0.032", 0.035"	$\pm 0.00102"$

PLASTIC FEELER GAUGES



4623-2

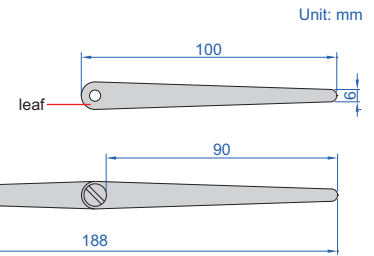

- Accuracy: $\pm 0.04\text{mm}$ (thickness of leaves: 0.25mm)
- $\pm 0.05\text{mm}$ (thickness of leaves: 0.5mm)
- $\pm 0.08\text{mm}$ (thickness of leaves: $\geq 1\text{mm}$)

Code	Range	Thickness of leaves included	Quantity of leaves
4623-2	0.25-2.00mm	2.00mm (0.078"), 1.00mm (0.039"), 0.50mm (0.020"), 0.50mm (0.020"), 0.50mm (0.020"), 0.25mm (0.010"), 0.25mm (0.010"), 1.00mm (0.039"), 2.00mm (0.078"), 1.00mm (0.039"), 2.00mm (0.078"), 1.00mm (0.039"), 2.00mm (0.078")	13
4623-5	0.25-5.00mm	1.00mm (0.039"), 0.25mm (0.010"), 0.50mm (0.020"), 1.50mm (0.059"), 2.00mm (0.078"), 2.50mm (0.098"), 3.00mm (0.118"), 3.50mm (0.138"), 4.00mm (0.157"), 4.50mm (0.177"), 5.00mm (0.196")	11

PLASTIC FEELER GAUGE

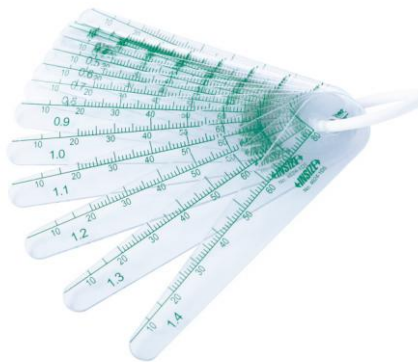

4624-1D5

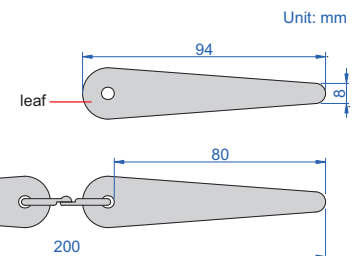

- Accuracy: $\pm 0.02\text{mm}$ (thickness of leaves: 0.05-0.1mm)
- $\pm 0.03\text{mm}$ (thickness of leaves: 0.15-0.6mm)
- $\pm 0.04\text{mm}$ (thickness of leaves: $\geq 0.7\text{mm}$)

Code	Range	Thickness of leaves included (mm)	Quantity of leaves
4624-1D5	0.05-1.5mm	0.05, 0.1, 0.15, 0.2, 0.3, 0.4, 0.5, 0.6, 0.7, 0.8, 0.9, 1.0, 1.1, 1.2, 1.3, 1.4, 1.5	17

FEELER GAUGE STOCKS



4622-10

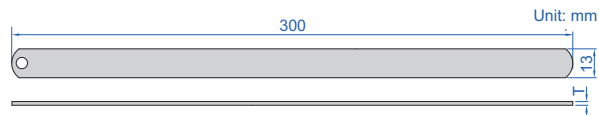

- Used as shims to accurately set spacing
- Made of hardened alloy steel
- Length 300mm
- Width 13mm
- 10 pcs per package

Code	Thickness (T)	Accuracy
4622-02	0.02mm	±3μm
4622-03	0.03mm	±3μm
4622-04	0.04mm	±3μm
4622-05	0.05mm	±3μm
4622-06	0.06mm	±3μm
4622-07	0.07mm	±4μm
4622-08	0.08mm	±4μm
4622-09	0.09mm	±4μm
4622-10	0.10mm	±4μm
4622-12	0.12mm	±5μm

Code	Thickness (T)	Accuracy
4622-15	0.15mm	±5μm
4622-18	0.18mm	±6μm
4622-20	0.20mm	±6μm
4622-25	0.25mm	±6μm
4622-30	0.30mm	±7μm
4622-35	0.35mm	±7μm
4622-40	0.40mm	±8μm
4622-45	0.45mm	±8μm
4622-50	0.50mm	±9μm
4622-55	0.55mm	±9μm

Code	Thickness (T)	Accuracy
4622-60	0.60mm	±9μm
4622-65	0.65mm	±9μm
4622-70	0.70mm	±12μm
4622-75	0.75mm	±12μm
4622-80	0.80mm	±13μm
4622-85	0.85mm	±13μm
4622-90	0.90mm	±14μm
4622-95	0.95mm	±14μm
4622-100	1.00mm	±16μm

FEELER GAUGE ROLLS



4621-30

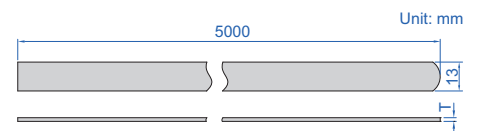

Code	Thickness (T)	Accuracy
4621-02	0.02mm	±4μm
4621-03	0.03mm	±4μm
4621-04	0.04mm	±4μm
4621-05	0.05mm	±4μm
4621-06	0.06mm	±4μm
4621-07	0.07mm	±5μm
4621-08	0.08mm	±5μm
4621-09	0.09mm	±5μm
4621-10	0.10mm	±5μm
4621-12	0.12mm	±5μm
4621-15	0.15mm	±6μm
4621-18	0.18mm	±7μm
4621-20	0.20mm	±8μm
4621-25	0.25mm	±9μm

Code	Thickness (T)	Accuracy
4621-30	0.30mm	±9μm
4621-35	0.35mm	±11μm
4621-40	0.40mm	±12μm
4621-45	0.45mm	±12μm
4621-50	0.50mm	±14μm
4621-55	0.55mm	±14μm
4621-60	0.60mm	±14μm
4621-65	0.65mm	±14μm
4621-70	0.70mm	±17μm
4621-75	0.75mm	±17μm
4621-80	0.80mm	±19μm
4621-85	0.85mm	±19μm
4621-90	0.90mm	±22μm
4621-95	0.95mm	±22μm
4621-100	1.00mm	±24μm

- Used as shims to accurately set spacing
- Made of hardened alloy steel
- Length 5m
- Width 13mm

PITCH GAUGES

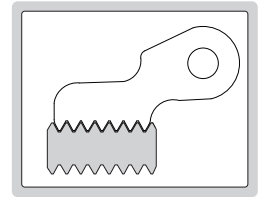

- Identify the pitch of screw thread
- Made of medium carbon steel

4820-122

Metric 60° screw

Code	Range	Pitch of leaves included (mm)	Quantity of leaves
4820-122	0.4-7.0mm	0.4, 0.5, 0.6, 0.7, 0.75, 0.8, 0.9, 1, 1.25, 1.5, 1.75, 2, 2.5, 3, 3.5, 4, 4.5, 5, 5.5, 6, 6.5, 7	22
4820-124	0.25-7.0mm	0.25, 0.3, 0.35, 0.4, 0.5, 0.7, 0.75, 0.8, 0.9, 1, 1.25, 1.5, 1.75, 2, 2.5, 3, 3.5, 4, 4.5, 5, 5.5, 6, 6.5, 7	24
4820-1241	0.25-6.0mm	0.25, 0.3, 0.35, 0.4, 0.45, 0.5, 0.6, 0.7, 0.75, 0.8, 0.9, 1, 1.25, 1.5, 1.75, 2, 2.5, 3, 3.5, 4, 4.5, 5, 5.5, 6	24

Unified 60° screw

Code	Range	Pitch of leaves included	Quantity of leaves
4820-230	4-42TPI	4, 4-1/2, 5, 5-1/2, 6, 7, 8, 9, 10, 11, 11-1/2, 12, 13, 14, 15, 16, 18, 20, 22, 24, 26, 27, 28, 30, 32, 34, 36, 38, 40, 42TPI	30

Whitworth 55° screw

Code	Range	Pitch of leaves included	Quantity of leaves
4820-330	4-42TPI	4, 4-1/2, 5, 5-1/2, 6, 7, 8, 9, 10, 11, 12, 13, 14, 15, 16, 18, 19, 20, 22, 24, 26, 27, 28, 30, 32, 34, 36, 38, 40, 42TPI	30
4820-328	4-62TPI	4, 4-1/2, 5, 6, 7, 8, 9, 10, 11, 12, 13, 14, 16, 18, 19, 20, 22, 24, 25, 26, 28, 30, 32, 36, 40, 48, 60, 62TPI	28

Metric 60° and Whitworth 55° screw

Code	Range	Pitch of leaves included	Quantity of leaves
4820-452	0.25-6.0mm	0.25, 0.3, 0.35, 0.4, 0.45, 0.5, 0.6, 0.7, 0.75, 0.8, 0.9, 1, 1.25, 1.5, 1.75, 2, 2.5, 3, 3.5, 4, 4.5, 5, 5.5, 6mm	52
	4-62TPI	4, 4-1/2, 5, 6, 7, 8, 9, 10, 11, 12, 13, 14, 16, 18, 19, 20, 22, 24, 25, 26, 28, 30, 32, 36, 40, 48, 60, 62TPI	
4820-450	0.4-7.0mm	0.4, 0.5, 0.6, 0.7, 0.75, 0.8, 0.9, 1, 1.25, 1.5, 1.75, 2, 2.5, 3, 3.5, 4, 4.5, 5, 5.5, 6, 6.5, 7mm	50
	4-62TPI	4, 4-1/2, 5, 6, 7, 8, 9, 10, 11, 12, 13, 14, 16, 18, 19, 20, 22, 24, 25, 26, 28, 30, 32, 36, 40, 48, 60, 62TPI	

Metric 60° and Unified 60° screw

Code	Range	Pitch of leaves included	Quantity of leaves
4820-552	0.4-7.0mm	0.4, 0.5, 0.6, 0.7, 0.75, 0.8, 0.9, 1, 1.25, 1.5, 1.75, 2, 2.5, 3, 3.5, 4, 4.5, 5, 5.5, 6, 6.5, 7mm	52
	4-42TPI	4, 4-1/2, 5, 5-1/2, 6, 7, 8, 9, 10, 11, 11-1/2, 12, 13, 14, 15, 16, 18, 20, 22, 24, 26, 27, 28, 30, 32, 34, 36, 38, 40, 42TPI	

PITCH GAUGES

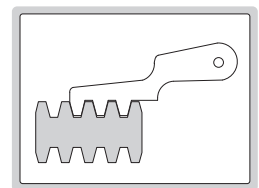

- Check the pitch of screw thread
- Accuracy: ± 0.07 mm
- Made of medium carbon steel

4824-12

Code	Range	Thread type	Pitch of leaves included	Quantity of leaves
4824-12	2-20mm	Tr30°	2, 3, 4, 5, 6, 7, 8, 9, 10, 12, 16, 20mm	12
4824-16	1-12TPI	ACME 29°	1, 1-1/3, 1-1/2, 1-3/4, 2, 2-1/2, 3, 3-1/2, 4, 5, 6, 7, 8, 9, 10, 12TPI	16

GEAR TOOTH PITCH GAUGES

- Check the module pitch of gear tooth
- Accuracy: $\pm 0.05\text{mm}$
- Made of hardened stainless steel

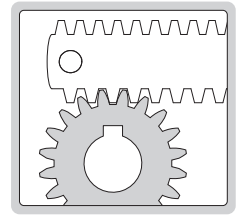

4860-245

Code	Range	Pressure angle	Quantity of leaves
4860-145	0.35-4.5mm	14.5°	15
4860-245	0.35-4.5mm	20°	15
4860-112	5-12mm	14.5°	8
4860-212	5-12mm	20°	8

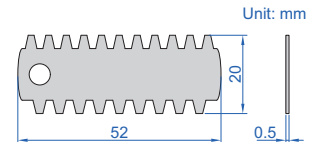

CENTER GAUGES

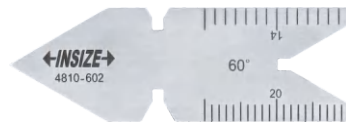
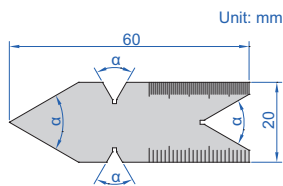

4810-602

- To check and set screw cutting tools, and check the angle and pitch of screw thread
- Angle accuracy: $\pm 30\text{min}$.
- Made of stainless steel

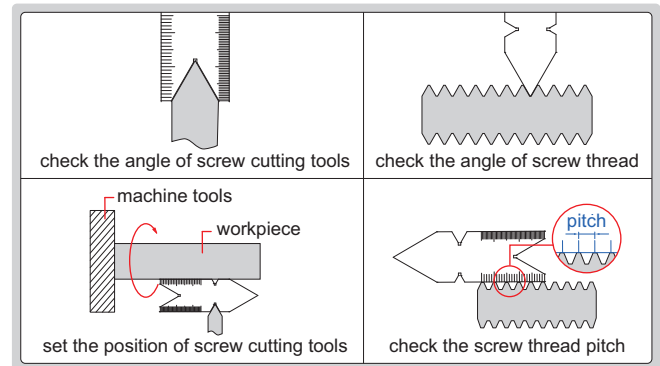

Code	Thread type	Angle (α)	Graduation
4810-601	METRIC 60°	60°	0.5mm and 1mm
4810-602	UNIFIED 60°	60°	14ths and 20ths on front side, 24ths and 32ths on back side
4810-55	WHITWORTH 55°	55°	14ths and 20ths on front side, 24ths and 32ths on back side

THREAD GAUGES

15



4812-E

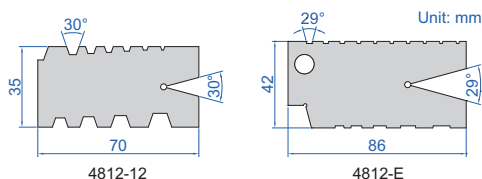

- To check and set screw cutting tools
- Made of medium carbon steel

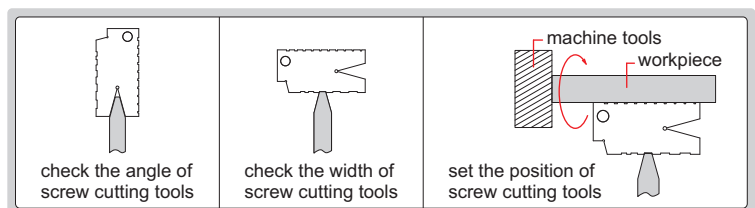

Code	Range	Thread type	Pitch
4812-12	2-12mm	Tr 30°	2, 3, 4, 5, 6, 7, 8, 9, 10, 12mm
4812-E	1-10TPI	ACME 29°	1, 1-1/3, 1-1/2, 1-3/4, 2, 2-1/2, 3, 4, 5, 6, 7, 8, 9, 10TPI

ANGLE GAUGE

- To check complementary angles
- Made of stainless steel



4806-20

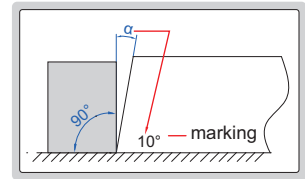

Code	Range (α)	Angle of leaves included	Quantity of leaves	Accuracy
4806-20	1°-45°	1°, 2°, 3°, 4°, 5°, 6°, 7°, 8°, 9°, 10°, 12°, 14°, 16°, 18°, 20°, 25°, 30°, 35°, 40°, 45°	20	±30'

ANGLE GAUGE SET

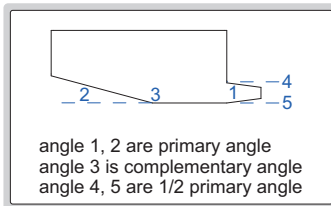

type A

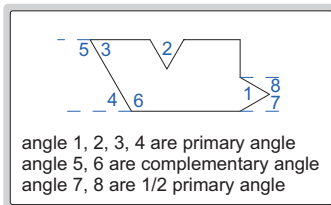

type B



4807

Primary angle	1/2 primary angle	Complementary angle	Type
5°	2°30'	175°	A
10°	5°	170°	A
15°	7°30'	165°	A
20°	10°	160°	B
25°	12°30'	155°	B
30°	15°	150°	B
35°	17°30'	145°	B
40°	20°	140°	B
45°	22°30'	135°	B
50°	25°	130°	B
55°	27°30'	125°	B
60°	30°	120°	B
65°	32°30'	115°	B
70°	35°	110°	B
75°	37°30'	105°	B
80°	40°	100°	B
85°	42°30'	95°	B
90°	45°	90°	B

- Each blade checks primary, 1/2 primary and complementary angles
- Made of medium carbon steel

Code	Quantity of leaves	Accuracy
4807	18	±10'

15 RADIUS GAUGES

- Made of medium carbon steel



4801-17

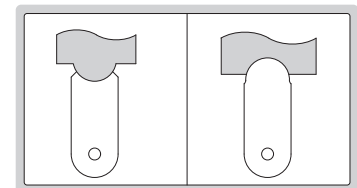

Code	Range	Radius of leaves included (mm)	Quantity of leaves (internal + external)
4801-17	1-7mm	1, 1.25, 1.5, 1.75, 2, 2.25, 2.5, 2.75, 3, 3.5, 4, 4.5, 5, 5.5, 6, 6.5, 7	17+17
4801-16	7.5-15mm	7.5, 8, 8.5, 9, 9.5, 10, 10.5, 11, 11.5, 12, 12.5, 13, 13.5, 14, 14.5, 15	16+16
4801-15	15.5-25mm	15.5, 16, 16.5, 17, 17.5, 18, 18.5, 19, 19.5, 20, 21, 22, 23, 24, 25	15+15

RADIUS GAUGES



4802-31



4802-51

- Made of stainless steel

Code	Range	Radius of leaves included (mm)	Quantity of leaves
4802-31	25-40mm	25, 25.5, 26, 26.5, 27, 27.5, 28, 28.5, 29, 29.5, 30, 30.5, 31, 31.5, 32, 32.5, 33, 33.5, 34, 34.5, 35, 35.5, 36, 36.5, 37, 37.5, 38, 38.5, 39, 39.5, 40	31
4802-41	41-50mm	41, 42, 43, 44, 45, 46, 47, 48, 49, 50	10
4802-51	51-60mm	51, 52, 53, 54, 55, 56, 57, 58, 59, 60	10
4802-61	61-70mm	61, 62, 63, 64, 65, 66, 67, 68, 69, 70	10
4802-71	71-80mm	71, 72, 73, 74, 75, 76, 77, 78, 79, 80	10
4802-81	81-90mm	81, 82, 83, 84, 85, 86, 87, 88, 89, 90	10
4802-91	91-100mm	91, 92, 93, 94, 95, 96, 97, 98, 99, 100	10

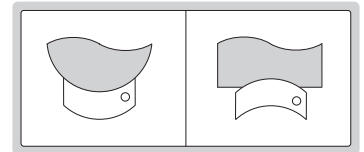

RADIUS GAUGE SET

- Each piece has 3 concave and 2 convex gauging surfaces
- Supplied with handle
- Made of medium carbon steel

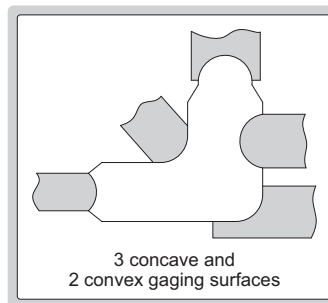

4804-26

Code	Range	Radius of leaves included (mm)	Quantity of leaves
4804-26	0.5-13mm	0.5, 1, 1.5, 2, 2.5, 3, 3.5, 4, 4.5, 5, 5.5, 6, 6.5, 7, 7.5, 8, 8.5, 9, 9.5, 10, 10.5, 11, 11.5, 12, 12.5, 13	26

DRILL POINT GAUGE

- For twist drills with 118° angle, to check if the center of tip is concentric with the drill body
- Made of stainless steel

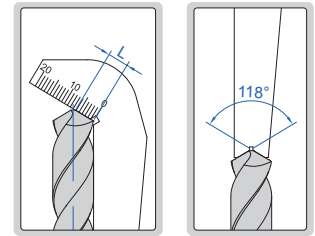

4843-1

Code	Accuracy	
	Angle	Length
4843-1	±0.5°	±0.5mm

DRILL ANGLE GAUGE

- Check drills with angle 60°, 70°, 90°, 118°, 125°, 135°, 150° or 160°
- Made of stainless steel

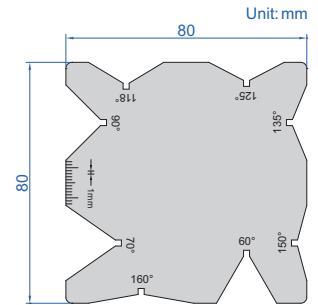

4842-1

Code	Accuracy
4842-1	±0.5°

ANGLE GAUGE

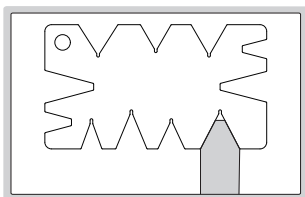

check the angle of screw cutting tools



4854-1

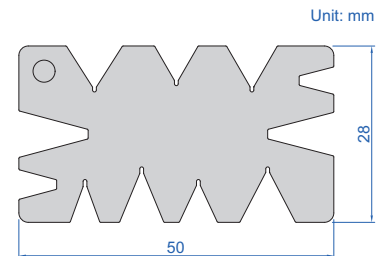

- Made of stainless steel

Code	Range	Accuracy
4854-1	29°, 30°, 40°, 45°, 50°, 55°, 60°	±10'

AMERICAN STANDARD WIRE GAUGE

No.	W
0	8.250mm/0.3249"
1	7.350mm/0.2893"
2	6.540mm/0.2576"
3	5.830mm/0.2294"
4	5.190mm/0.2043"
5	4.620mm/0.1819"
6	4.110mm/0.1620"
7	3.670mm/0.1443"
8	3.260mm/0.1285"
9	2.910mm/0.1144"
10	2.590mm/0.1019"
11	2.300mm/0.0907"
12	2.050mm/0.0808"
13	1.820mm/0.0720"
14	1.630mm/0.0641"
15	1.450mm/0.0571"
16	1.290mm/0.0508"
17	1.150mm/0.0453"

No.	W
18	1.020mm/0.0403"
19	0.912mm/0.0359"
20	0.813mm/0.0320"
21	0.724mm/0.0285"
22	0.643mm/0.0253"
23	0.574mm/0.0226"
24	0.511mm/0.0201"
25	0.440mm/0.0179"
26	0.404mm/0.0159"
27	0.361mm/0.0142"
28	0.320mm/0.0126"
29	0.287mm/0.0113"
30	0.254mm/0.0100"
31	0.226mm/0.0089"
32	0.203mm/0.0080"
33	0.180mm/0.0071"
34	0.160mm/0.0063"
35	0.142mm/0.0056"
36	0.127mm/0.0050"



4808

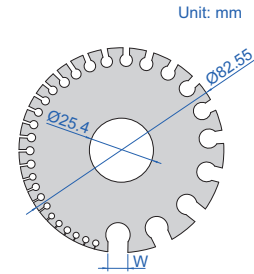

Code	Range
4808	0-36 (8.250-0.127mm/0.3249-0.0050")

- For gaging non-ferrous wire and metals such as copper, brass and aluminum
- Hardened to HRC50-57

U.S. STANDARD SHEET METAL GAUGE

No.	W
0	7.938mm/0.3125"
1	7.144mm/0.2813"
2	6.747mm/0.2656"
3	6.350mm/0.2500"
4	5.953mm/0.2344"
5	5.556mm/0.2188"
6	5.159mm/0.2031"
7	4.763mm/0.1875"
8	4.366mm/0.1719"
9	3.969mm/0.1563"
10	3.572mm/0.1406"
11	3.175mm/0.1250"
12	2.778mm/0.1094"
13	2.381mm/0.0938"
14	1.984mm/0.0781"
15	1.786mm/0.0703"
16	1.588mm/0.0625"
17	1.429mm/0.0563"

No.	W
18	1.270mm/0.0500"
19	1.111mm/0.0438"
20	0.953mm/0.0375"
21	0.873mm/0.0344"
22	0.794mm/0.0313"
23	0.714mm/0.0281"
24	0.635mm/0.0250"
25	0.556mm/0.0219"
26	0.476mm/0.0188"
27	0.437mm/0.0172"
28	0.397mm/0.0156"
29	0.357mm/0.0141"
30	0.318mm/0.0125"
31	0.278mm/0.0109"
32	0.258mm/0.0102"
33	0.238mm/0.0094"
34	0.218mm/0.0086"
35	0.198mm/0.0078"
36	0.179mm/0.0070"



4809

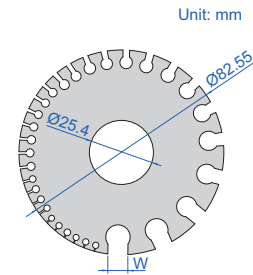

Code	Range
4809	0-36 (7.938-0.179mm/0.3125-0.0070")

- For gaging sheet metal, plate iron and steel
- Hardened to HRC50-57

WIRE GAUGE

Wire diameter (W)
0.200mm
0.224mm
0.250mm
0.280mm
0.315mm
0.355mm
0.400mm
0.450mm
0.500mm
0.560mm
0.630mm
0.710mm
0.750mm
0.800mm
0.900mm
1.000mm
1.120mm
1.250mm
1.400mm
1.500mm

Wire diameter (W)
1.60mm
1.80mm
2.00mm
2.24mm
2.50mm
2.80mm
3.00mm
3.15mm
3.55mm
3.75mm
4.00mm
4.25mm
4.50mm
5.00mm
5.60mm
6.30mm
7.10mm
8.00mm
9.00mm
10.00mm

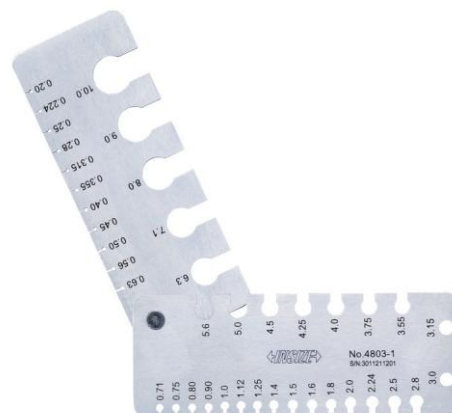

4803-1

Code	Range
4803-1	0.2-10mm

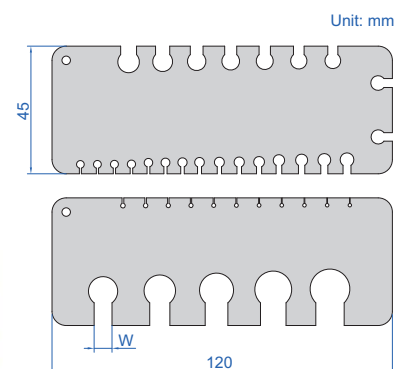

- For gaging non-ferrous wire and metals such as copper, brass and aluminum
- Hardened to HRC51-53
- Including 2 pcs wire gauges

THICKNESS GAUGE

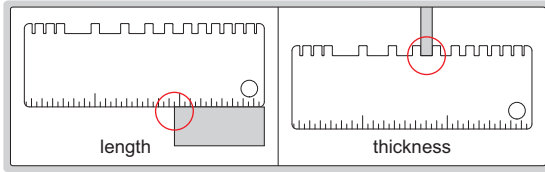

■ Made of stainless steel

Code	Measurement	Range	Graduation	Accuracy
4853-1	length	0-2 3/4"	1/16"	1/32"
	thickness	24GA. (0.0239"), 22GA. (0.0299"), 20GA. (0.0359")	—	±0.002"
		18GA. (0.0478"), 16GA. (0.0598"), 14GA. (0.0747"), 1/8" (0.125"), 10GA. (0.1345"), 3/16" (0.1875"), 1/4" (0.250"), 5/16" (0.3125")		±0.004"
	0.024", 0.030", 0.035"		±0.002"	

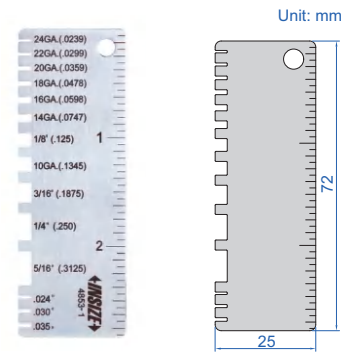

4853-1

DIGITAL TAPER SLOT GAUGES

DIRECT READING,
CALCULATION IS NOT REQUIRED

DATA
OUTPUT



1160-10

- Non waterproof
- Measuring opening, slot width
- Resolution: 0.01mm/0.0005"
- Buttons: on/off, zero, mm/inch
- Automatic power off, move the digital unit to turn on power
- Battery CR2032
- Data output
- Made of stainless steel
- Optional accessory:
 - wireless transmitter code **7315-25** (receiver is needed) page 5,
 - bluetooth transmitter code **7214-25** page 11,
 - data output cable code **7302-21** page 20

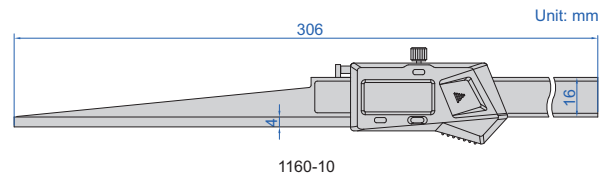

1160-10

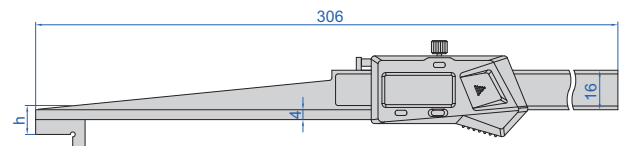

1160-20, 1160-30, 1160-40

Code	Range	Accuracy	h
1160-10	0.2-10mm/0.01-0.39"	±0.03mm	—
1160-20	10-20mm/0.39-0.79"	±0.05mm	10mm
1160-30	20-30mm/0.79-1.18"	±0.05mm	20mm
1160-40	30-40mm/1.18-1.58"	±0.05mm	30mm

measure slot width

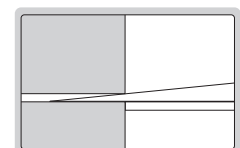

TAPER SLOT GAUGES

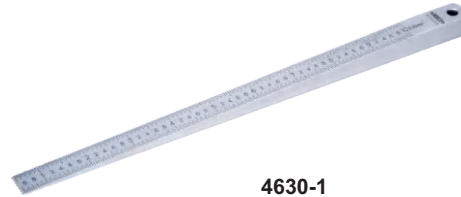
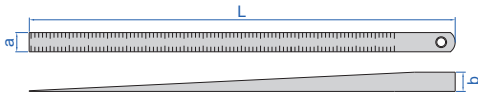

4630-1

- For quick measurement of slot width
- Satin chrome plated reading surface
- Made of stainless steel

Code	Range	Graduation	Accuracy	L	a	b
4630-3	0.4-6mm	0.05mm	±0.04mm	164mm	12.5mm	6.5mm
4630-1	0.5-10mm	0.05mm	±0.07mm	220mm	10mm	10.5mm
4630-2	0.5-15mm	0.1mm	±0.08mm	184mm	12.5mm	16.5mm

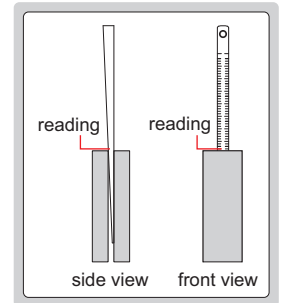

TAPER GAUGES

measure slot width

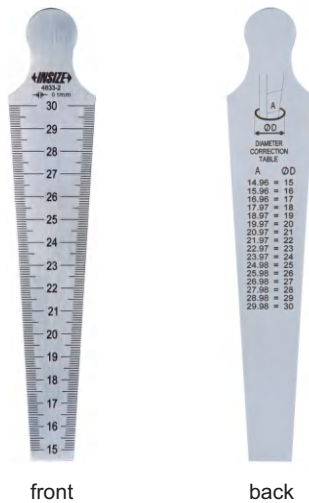
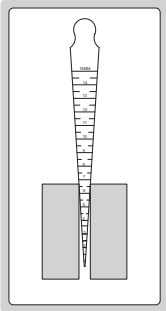

front

back

4833-2

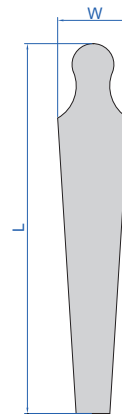

- Measure opening, slot width, hole diameter, etc.
- Diameter correction table on the back (only for 4833-1, 4833-2)
- Made of stainless steel

Code	Range	Graduation	Accuracy	L	W
4833-1	0.8-15mm	0.1mm	±0.05mm	146mm	17mm
4833-2	15-30mm	0.1mm	±0.05mm	159mm	30.4mm
4833-3	30-45mm	0.1mm	±0.05mm	166mm	45.4mm
4833-4	45-60mm	0.1mm	±0.05mm	170mm	60.5mm

measure diameter of hole

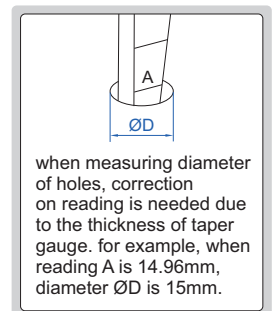

TAPER GAUGE SET



front

back

4837-1

- Include 4 pcs (1~8mm, 8~15mm, 15~22mm, 22~29mm)
- Measure opening, slot width, hole diameter, etc.
- Diameter correction table on the back
- Made of stainless steel

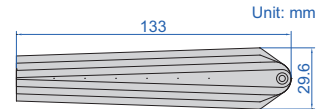

measure diameter of hole

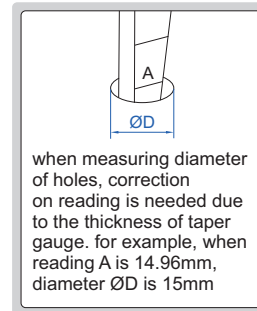

measure slot width

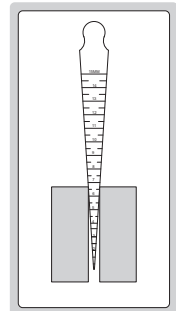

Code	Range	Graduation	Accuracy
4837-1	1-29mm	0.05mm	±0.05mm

TAPER GAUGE AND STEEL RULER SET

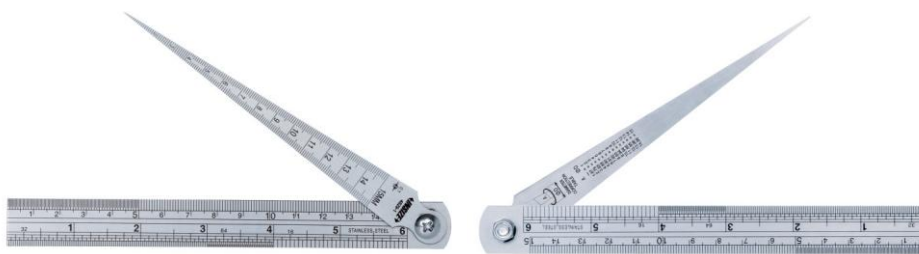

front

back

4829-1

use the taper gauge to measure slot width

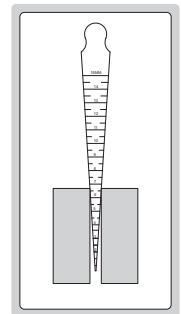

Unit: mm

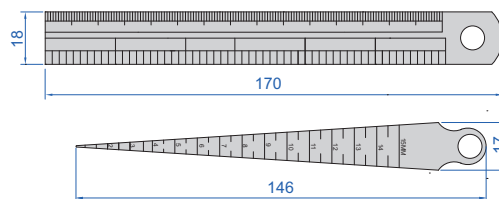

- Diameter correction table on the taper gauge back
- Made of stainless steel

use the taper gauge to measure diameter of hole

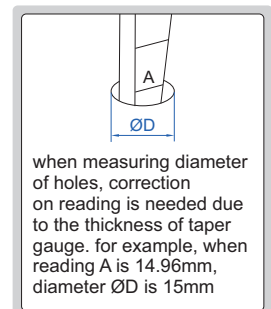

Code	Tool	Range	Graduation	Accuracy
4829-1	taper gauge	0.8-15mm	0.1mm	±0.05mm
	steel ruler	150mm/6"	1.0mm	±0.18mm

TAPER BORE GAUGES

- Quick measurement of bore diameter
- Hardened steel, HRC50-58
- Satin chrome plated surface
- Aluminium oxidized handle

Code	Range	Graduation	Accuracy	L	Ød1	Ød2
4852-1	1-6.5mm	0.1mm	±0.05mm	62.5	7	0.8
4852-3	3-16mm	0.1mm	±0.05mm	143	17	2.8
4852-15	15-30mm	0.1mm	±0.05mm	165	31	14.7
4852-30	30-45mm	0.1mm	±0.05mm	165	46	29.6
4852-45	45-60mm	0.1mm	±0.05mm	167	61	44.3



4852-15

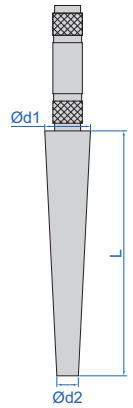

SMALL TAPER BORE GAUGE



4855-5

- Quick measurement of small bore diameter
- Hardened working face
- Supplied with protection cap

Code	Range	Graduation	Accuracy
4855-5	0.1-5mm	0.01mm	±0.03mm

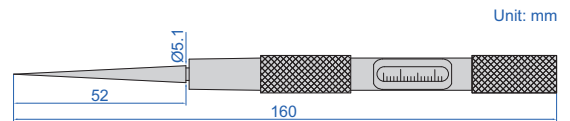

Unit: mm

supplied with protection cap



WELDING GAUGE

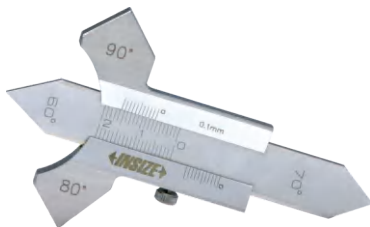

4830

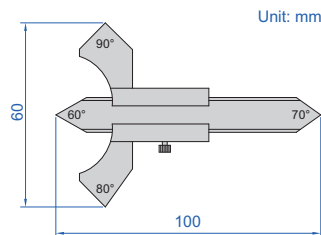

Unit: mm

- Made of stainless steel
- Satin chrome plated reading surface

Code	Measurement	Range	Graduation	Accuracy
4830	crown height	0-8mm	0.1mm	±0.1mm
	fillet weld throat size	0-20mm	0.1mm	±0.3mm
	angle	60°, 70°, 80°, 90°	—	±1°

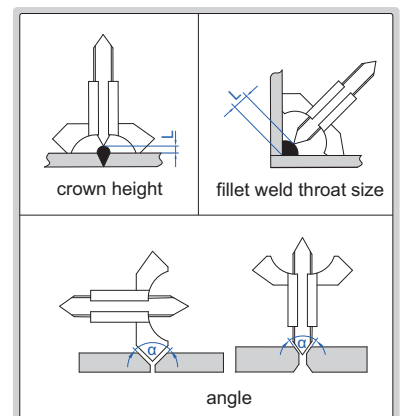

DIGITAL WELDING GAUGE

ATTENTION:
NO DATA OUTPUT



4831-20A

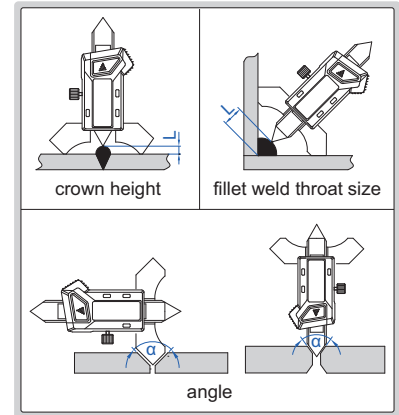
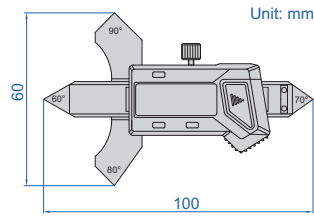

- Non waterproof
- Buttons: zero, mm/inch, on/off
- Battery LR44
- Made of stainless steel

Code	Measurement	Range	Resolution	Accuracy
4831-20A	crown height	0-7mm	0.01mm/0.0005"	±0.03mm
	fillet weld throat size	0-20mm	0.01mm/0.0005"	±0.1mm
	angle	60°, 70°, 80°, 90°	—	±1°

WELDING GAUGE



4850-1

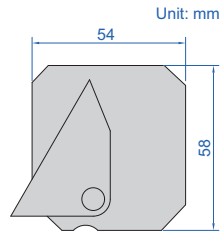

- Made of stainless steel

Code	Measurement	Range	Graduation	Accuracy
4850-1	leg height (b)	0-18mm	1mm	±0.5mm
	theoretical throat size (a)	2-12mm	1mm	±0.5mm
	throat size	4, 5, 6, 7mm	—	±0.5mm
	angle of preparation	50°, 60°	—	±1°
	thickness	1.5, 2, 3.5mm	—	±0.2mm

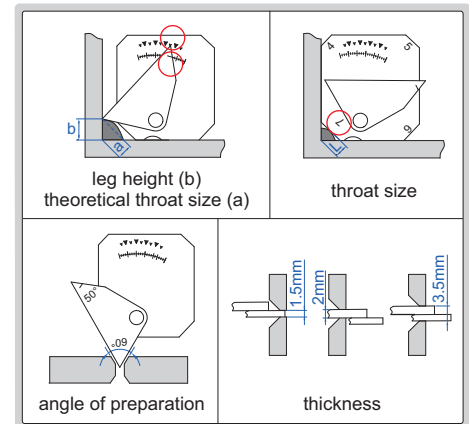

WELDING GAUGE

15

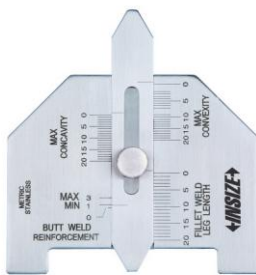

4851-1

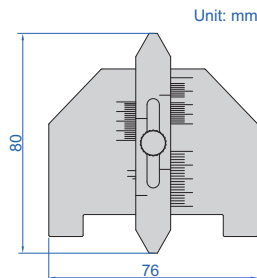

- Made of stainless steel

Code	Measurement	Range	Graduation	Accuracy
4851-1	leg height	0-20mm	1mm	±0.5mm
	crown height	0-3mm	—	±0.5mm
	theoretical leg height of convex weld	0-20mm	1mm	±0.5mm
	theoretical leg height of concave weld	0-20mm	1mm	±0.5mm

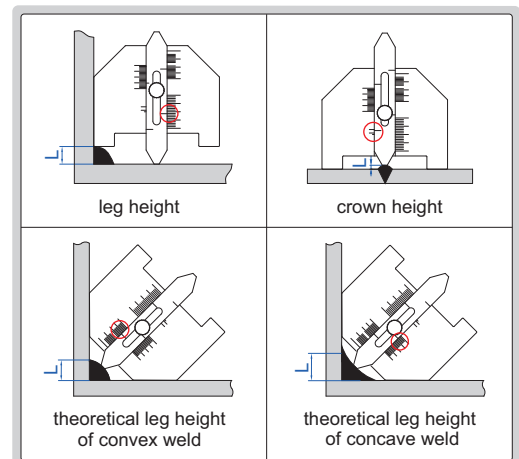

WELDING GAUGE

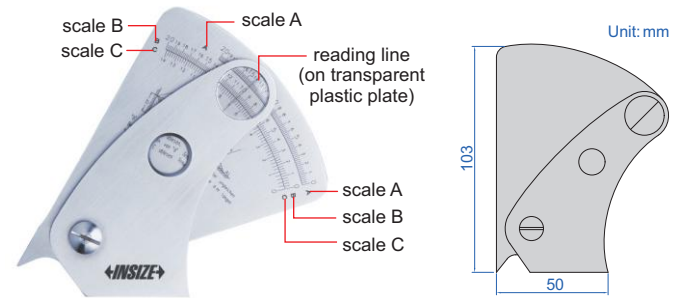
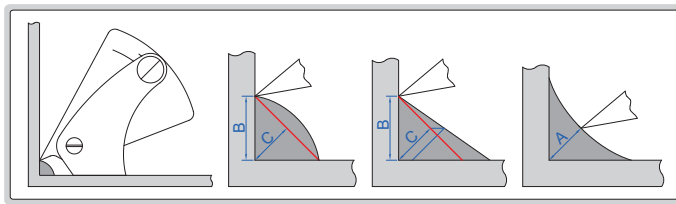

Code	Graduation	Accuracy
4840-1	0.2mm	±0.3mm

■ Made of stainless steel

4840-1

WELDING GAUGE

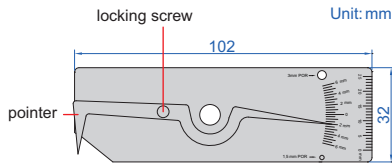

4834-1

- Pointer can be locked for later reference
- Made of stainless steel

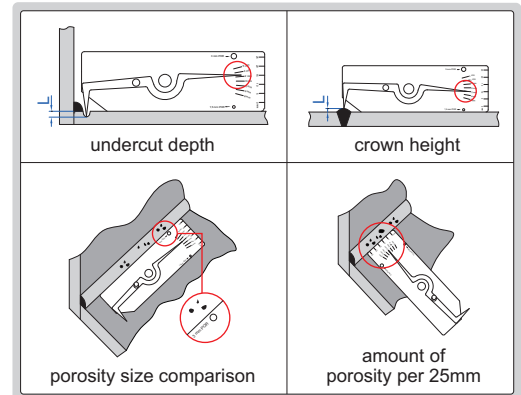

Code	Measurement	Range	Graduation	Accuracy
4834-1	undercut depth	0-6mm	0.5mm	±0.5mm
	crown height	0-6mm	0.5mm	±0.5mm
	porosity size comparison	1.5mm, 3mm	—	±0.2mm
	amount of porosity per 25mm	25mm	1mm	—

WELDING GAUGE

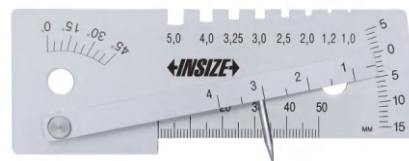
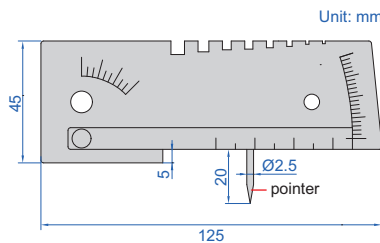

4848-1

- Made of stainless steel

Code	Measurement	Range	Graduation	Accuracy
4848-1	misalignment (high-low)	-5mm~+15mm	1mm	±0.5mm
	angle of preparation	0°-45°	5°	±2.5°
	length	0-50mm	1mm	±0.5mm
	gap	1-4mm	0.5mm	±0.25mm
	thickness	1, 1.2, 2.0, 2.5, 3.0, 3.25, 4.0, 5.0mm	—	—

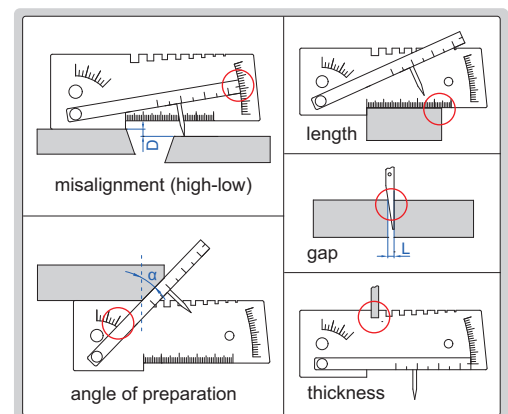

FILLET WELDING GAUGE

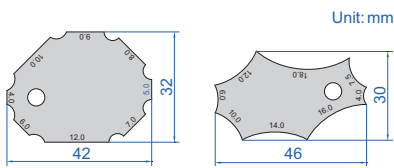

Unit: mm



4832-1

- Made of stainless steel
- Sizes marked on both faces

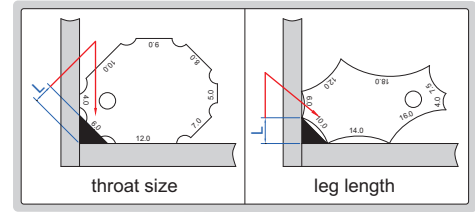

Code	Throat size	Leg length	Accuracy
4832-1	4, 5, 6, 7, 8, 9, 10, 12mm	4, 6, 7.5, 10, 12, 14, 16, 18mm	±0.5mm

FILLET WELDING GAUGES

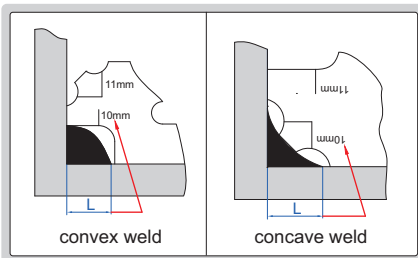

4836-1



4836-2

- Measure concave and convex weld sizes
- 7 blades are included
- Made of stainless steel

Code	Size	Accuracy
4836-1	3mm, 4mm, 5mm, 6mm, 8mm, 9mm, 10mm, 11mm, 12mm, 14mm, 16mm, 19mm, 22mm, 25mm	±0.5mm
4836-2	1/8" (3.2mm), 3/16" (4.8mm), 1/4" (6.4mm), 5/16" (7.9mm), 3/8" (9.5mm), 7/16" (11.1mm), 1/2" (12.7mm), 5/8" (15.9mm), 3/4" (19.1mm), 7/8" (22.2mm), 1" (25.4mm)	±0.02" (0.5mm)

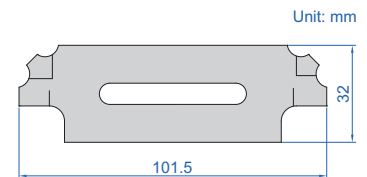

Unit: mm

FILLET WELDING GAUGE

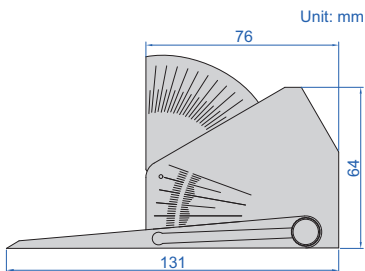

Unit: mm



4846-1

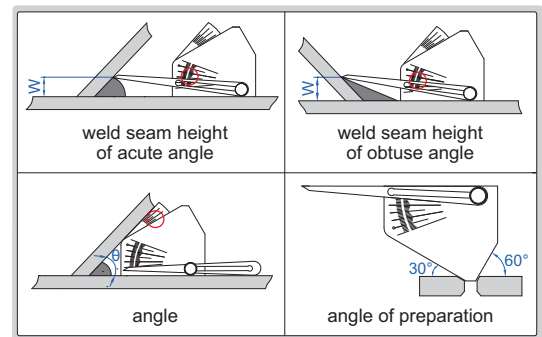

calculating card (included)

- Calculating card is included
- Made of stainless steel

Code	Measurement	Range	Graduation	Accuracy
4846-1	weld seam height W	0-50mm/0-2"	2mm/0.05"	±1mm
	angle θ	30°-90°	2.5°	±1°
	60° angle	—	—	±0.5°

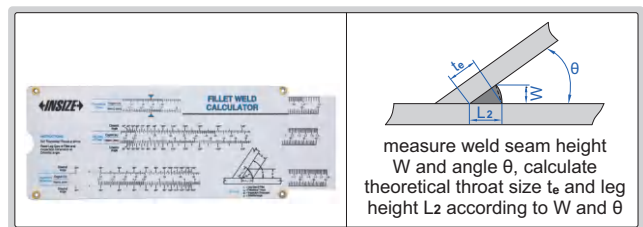

- Measure convex weld sizes
- 3 blades are included
- Made of stainless steel

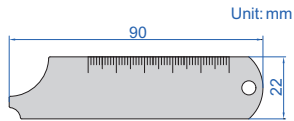

4847-1

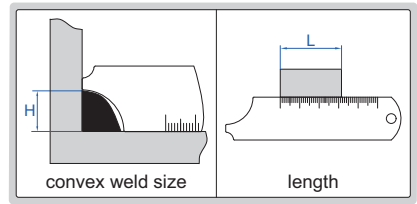

Code	Measurement	Range	Graduation	Accuracy
4847-1	convex weld size	4, 6, 8, 10, 12, 14mm	—	±0.5mm
	length	0-50mm	1mm	±0.5mm

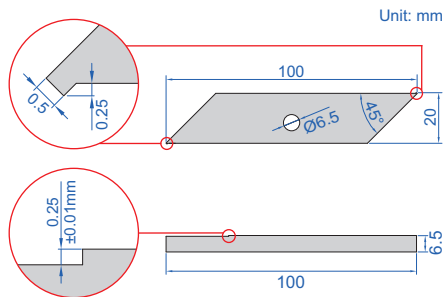

4849-1

calibration block (included)

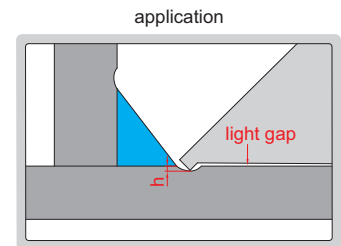

when there is a light gap, $h < 0.25\text{mm}$;
when there is no light gap, $h \geq 0.25\text{mm}$

Code
4849-1

- Measure undercut
- Calibration block is included
- Made of stainless steel

WELDING GAUGES

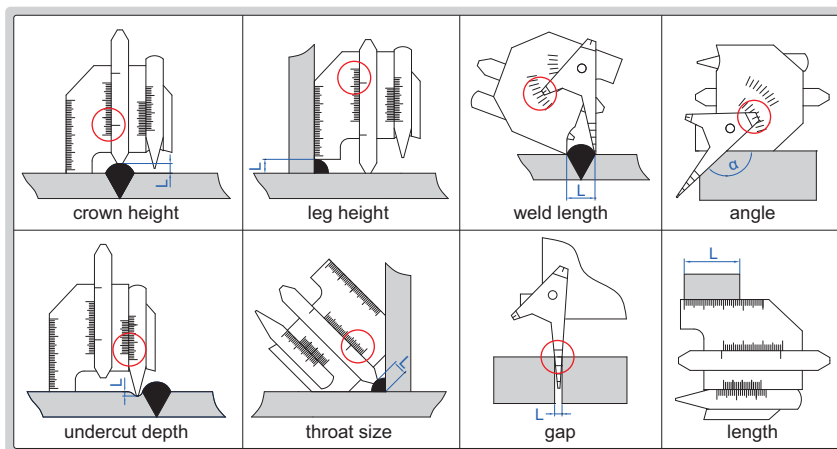

- Made of stainless steel

Measurement	Code 4838-1			Code 4838-2		
	Range	Graduation	Accuracy	Range	Graduation	Accuracy
crown height	0-10mm	1mm	±0.5mm	0-15mm	1mm	±0.5mm
leg height	0-14mm	1mm	±0.5mm	0-15mm	1mm	±0.5mm
undercut depth	0-5mm	0.05mm	±0.05mm	0-5mm	0.05mm	±0.05mm
throat size	0-13mm	1mm	±0.5mm	0-13mm	1mm	±0.5mm
weld length	0-40mm	1mm	±1mm	0-60mm	1mm	±1mm
angle	90°-150°	5°	±1°	80°-160°	5°	±1°
gap	0.5-5mm	1mm	±0.5mm	1-6mm	1mm	±0.5mm
length	0-40mm	1mm	±0.5mm	0-50mm	1mm	±0.5mm
LxW	62x77mm			99x84mm		

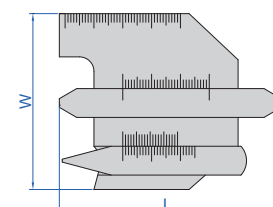
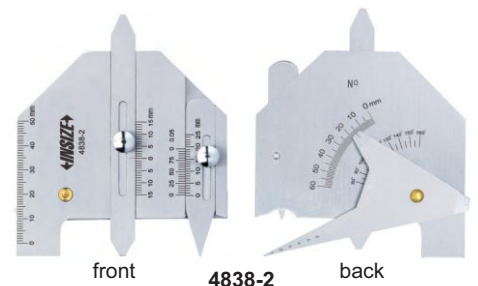
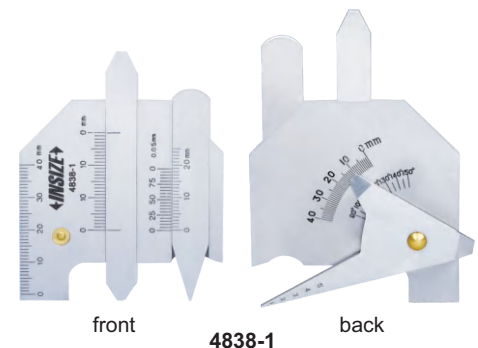

WELDING GAUGE

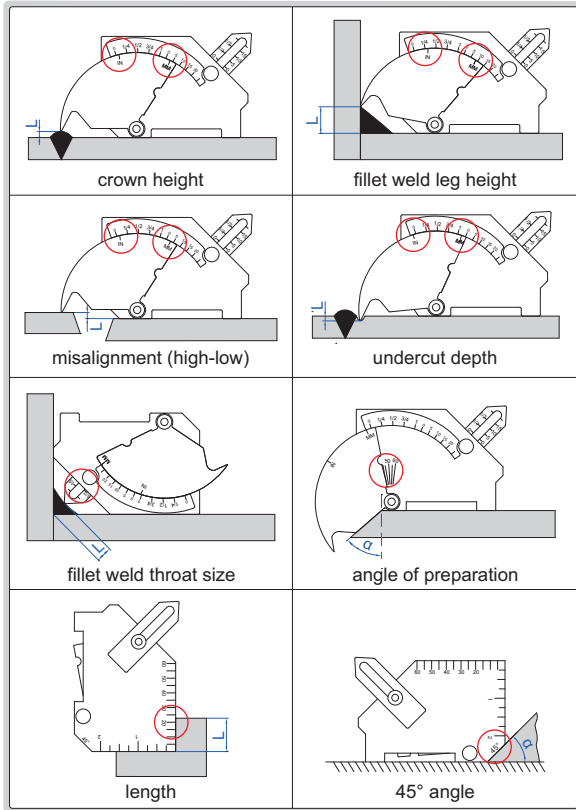

front

4835-1

back

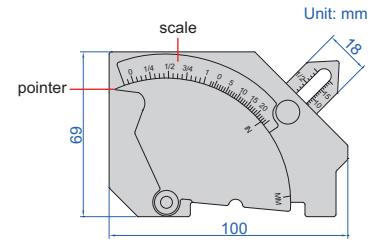

- Adjustable scale to compensate pointer wear
- Made of stainless steel

Code	Measurement	Range	Graduation	Accuracy
4835-1	crown height	0-25mm (0-1")	1mm (1/16")	±0.5mm
	fillet weld leg height	0-25mm (0-1")	1mm (1/16")	±0.5mm
	misalignment (high-low)	0-25mm (0-1")	1mm (1/16")	±0.5mm
	undercut depth	0-2mm (0-1/8")	1mm (1/16")	±0.5mm
	fillet weld throat size	0-20mm (0-3/4")	1mm (1/16")	±0.5mm
	angle of preparation	0-60°	5°	±1°
	length	0-60mm (0-2")	1mm (1/16")	±0.5mm
	45° angle	—	—	±1°

WELDING GAUGE

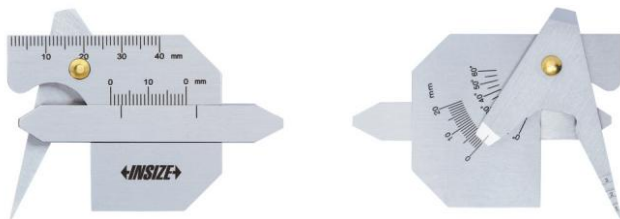

front

6832-1

back

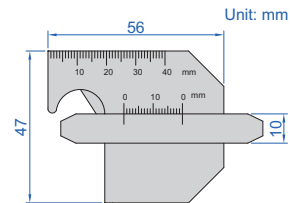

- Made of stainless steel
- Satin chrome plated surface

Code	Measurement	Range	Graduation	Accuracy
6832-1	leg length	0-20mm	1mm	±0.3mm
	leg height	0-20mm	1mm	±0.3mm
	crown height	0-20mm	1mm	±0.3mm
	throat size	0-10mm	1mm	±0.3mm
	angle	0°-60°	5°	±1°
	gap	1-3.5mm	0.5mm	±0.2mm
	length	0-40mm	1mm	±0.3mm

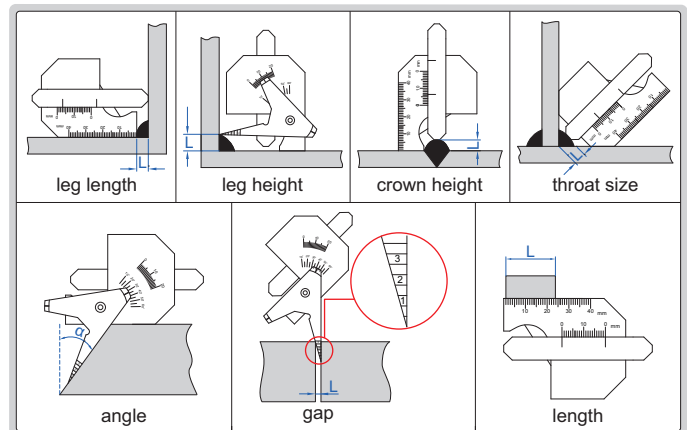

PIPE WELDING GAUGE

- Made of stainless steel

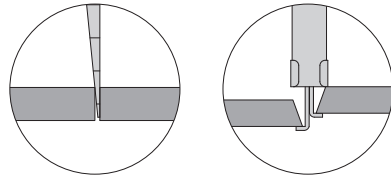

fit-up gap

internal misalignment



4841-1

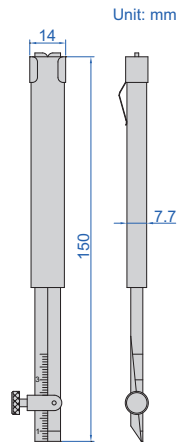

Unit: mm

Code	Measurement	Range	Graduation	Accuracy
4841-1	internal misalignment	0-30mm	1mm	±0.5mm
	fit-up gap	0.7-4mm	0.1mm	±0.1mm

PIPE WELDING GAUGE

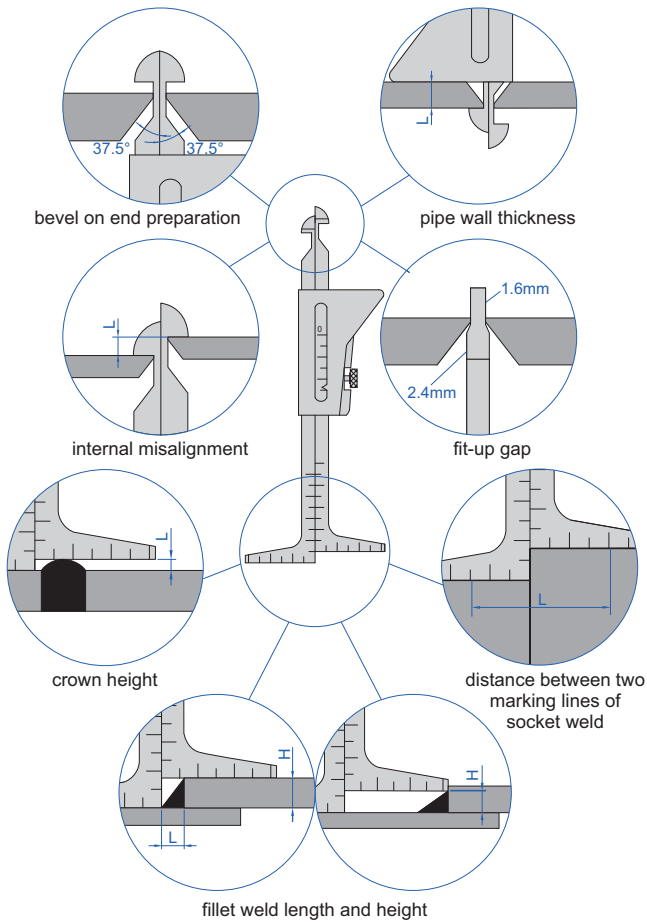

Unit: mm

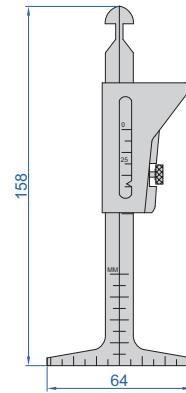

front

back

4839-1

Code	Measurement	Range	Graduation	Accuracy
4839-1	bevel on end preparation	37.5°	—	±1°
	pipe wall thickness	0-45mm (0~1-3/4")	1mm (1/16")	±0.5mm
	internal misalignment	0-35mm (0~1-3/8")	1mm (1/32")	±0.5mm
	fit-up gap	1.6mm, 2.4mm	—	±0.1mm
	crown height	0-35mm (0~1-3/8")	1mm (1/32")	±0.5mm
	distance between two marking lines of socket weld	0-60mm (0~2-3/8")	1mm (1/16")	±0.5mm
	fillet weld length	0-30mm (0~1-1/4")	1mm (1/16")	±0.5mm
	fillet weld height	0-35mm (0~1-3/8")	1mm (1/32")	±0.5mm

- Made of stainless steel

6-PIECE WELDING GAUGE SET

■ Includes:

- 1) Welding gauge (code **4834-1**)
- 2) Fillet welding gauge, size 3~25mm, 7 blades (code **4836-1**)
- 3) Pipe welding gauge (code **4841-1**)
- 4) Telescoping inspection mirror, size of mirror $\varnothing 32$ mm, length 178~505mm (code **7160-1**)
- 5) Pocket ruler with sliding clip, range 150mm/6", graduation 1mm, 1/64" (code **7119-150**)
- 6) LED flashlight (code **ISGF-0501**)

Code

5064



5064

7-PIECE WELDING GAUGE SET

■ Includes:

- 1) Welding gauge (code **4834-1**)
- 2) Welding gauge (code **4851-1**)
- 3) Pipe welding gauge (code **4839-1**)
- 4) Outside micrometer, range 0-25mm, graduation 0.01mm (code **3203-25A**)
- 5) Telescoping inspection mirror, size of mirror $\varnothing 32$ mm, length 178~505mm (code **7160-1**)
- 6) Magnifier with illumination, magnification 4X (code **7513-4**)
- 7) Steel ruler, range 150mm/6", graduation 0.5mm, 1mm, 1/64", 1/32", 1/16" (code **7110-150**)

Code

5071



5071

7-PIECE WELDING GAUGE SET

■ Includes:

- 1) Welding gauge (code **4834-1**)
- 2) Welding gauge (code **4851-1**)
- 3) Fillet welding gauge, size 3~25mm, 7 blades (code **4836-1**)
- 4) Outside micrometer, range 0-25mm, graduation 0.01mm (code **3203-25A**)
- 5) Digital caliper, range 0-150mm/0-6", resolution 0.01mm/0.005" (code **1108-150**)
- 6) Pocket ruler with sliding clip, range 150mm/6", graduation 1mm, 1/64" (code **7119-150**)
- 7) Magnifier with illumination, magnification 4X (code **7513-4**)

Code

5072



5072

INSIDE CALIPERS

- Made of carbon steel



7240-150

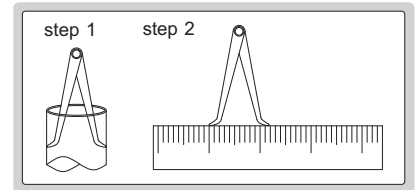
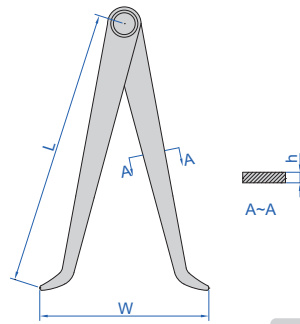

Code	Size (L)	Range (W)	h
7240-150	150mm	17-150mm	2mm
7240-200	200mm	17-200mm	3mm
7240-300	300mm	18-300mm	3mm

OUTSIDE CALIPERS

- Made of carbon steel



7241-150

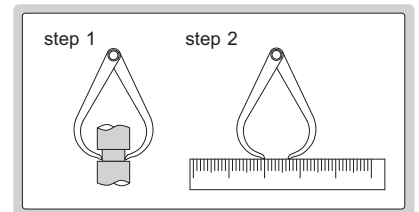
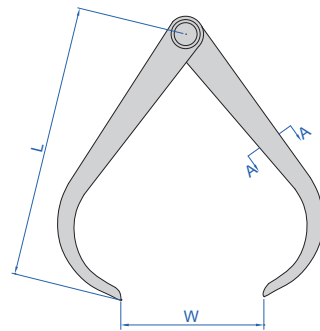

Code	Size (L)	Range (W)	h
7241-150	150mm	0-150mm	2mm
7241-200	200mm	0-200mm	3mm
7241-300	300mm	0-300mm	3mm

INSIDE SPRING CALIPERS



tips

- Made of carbon steel



7261-150

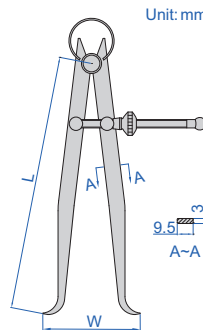

Unit: mm

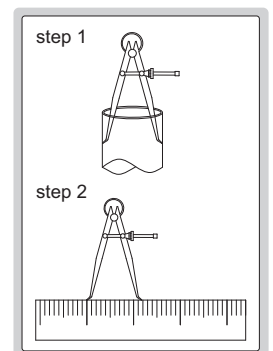

Code	Size (L)	Range (W)
7261-150	150mm	20-150mm
7261-200	200mm	22-200mm
7261-250	245mm	30-250mm
7261-300	300mm	30-300mm

OUTSIDE SPRING CALIPERS



- Made of carbon steel

Code	Size (L)	Range (W)
7262-150	155mm	0-150mm
7262-200	210mm	0-200mm
7262-250	265mm	0-250mm
7262-300	310mm	0-300mm



7262-150

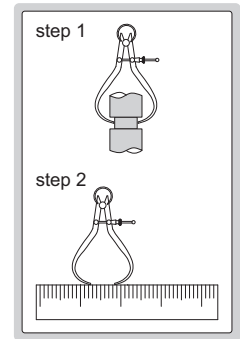
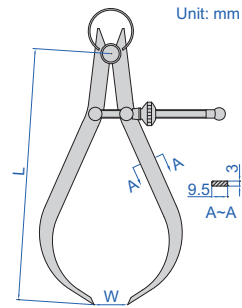

SPRING DIVIDERS

- Made of carbon steel
- Hardened points

Code	Size (L)	Range (W)
7260-150	150mm	0-150mm
7260-200	200mm	0-210mm
7260-250	245mm	0-260mm
7260-300	300mm	0-320mm



7260-150

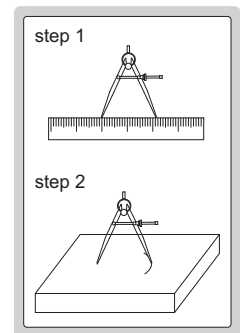
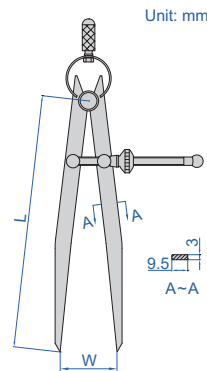

DIVIDERS

- Made of carbon steel
- Hardened points

Code	Size (L)	Range (W)	(mm)	
			a	b
7247-150	150mm	0-140mm	8.5	7
7247-200	200mm	0-190mm	10	7
7247-300	300mm	0-290mm	12	7



7247-150

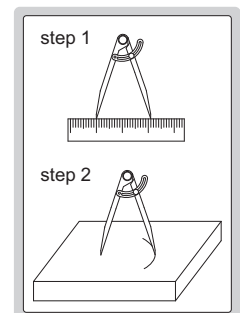
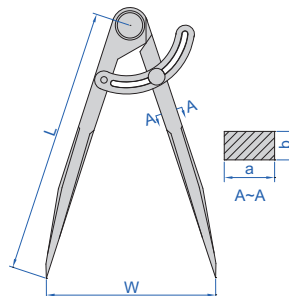



WIRELESS DIGITAL MEASURING TAPES + LASER DISTANCE METERS

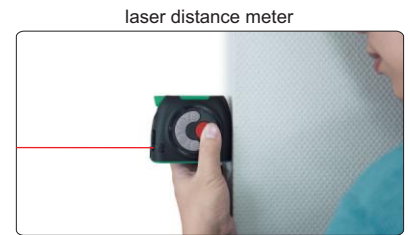
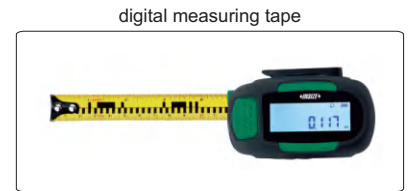

- Built-in bluetooth or wireless Zigbee transmission
- Display with backlight
- Automatic power off: laser 30s, main unit 180s
- Can work continuously for 5 hours
- Can store 50 groups of measurement data

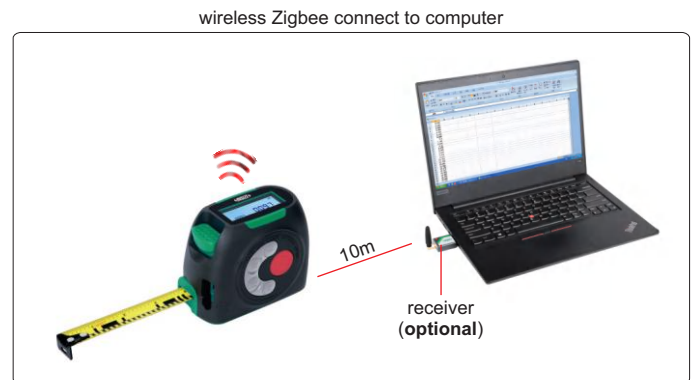

SPECIFICATION

Code	9563-C40	9563-C60	9563-WL40	9563-WL60	
Output	bluetooth (data can be transmitted to APP)		wireless Zigbee (optional receiver needed: code 7315-2/3/6/7/8/9) (data can be transmitted to excel, word, txt etc.)		
Digital measuring tape	range	5m			
	resolution	0.001m			
	accuracy	±1.5mm			
	blade width	19mm			
horizontal stand-out	≥1.8m				
Laser distance meter	range	40m	60m	40m	60m
	resolution	0.001m			
	accuracy	±(3+D/20)mm, D: measured distance, unit: m			
	units	m, ft, in, ft+in			
	laser type	630~670nm, <1mW, class 2			
measurement function	single, continuous, area, volume, pythagoras measurement				
Operation temperature	0~40°C				
Storage temperature	-10~60°C				
Power supply	built-in rechargeable lithium battery				
Dimension (L×W×H)	95×74×56mm				
Weight	313g				

MEASURING TAPES

EG II

graduation



7140-5

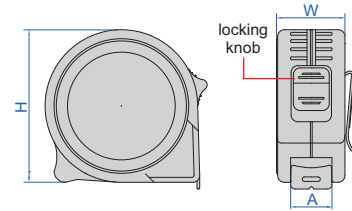

- With TPR round case
- Non-glare nylon surface for wear resistance
- Accuracy: $\pm(0.3+0.2L)$ mm (L is the measured length rounded up to the next whole meter), meet MI-008 of DIRECTIVE 2014/32/EU

Individual (1 pc per package)

Code	Range	Graduation	Width of tape A	W	H
7140-3	0-3m	1mm	16mm	28mm	62mm
7140-5	0-5m	1mm	19mm	30mm	68mm
7140-8	0-8m	1mm	25mm	38mm	78mm

Set (12 pcs per package)

Code	Range	Graduation	Width of tape A	W	H
7140-3A	0-3m	1mm	16mm	28mm	62mm
7140-5A	0-5m	1mm	19mm	30mm	68mm
7140-8A	0-8m	1mm	25mm	38mm	78mm

MEASURING TAPES (ECONOMIC TYPE)

EG II



7147-5



7147-5S

- With TPR round case
- Non-glare nylon surface for wear resistance
- Accuracy: $\pm(0.3+0.2L)$ mm (L is the measured length rounded up to the next whole meter), meet MI-008 of DIRECTIVE 2014/32/EU

Individual

Code	Range	Graduation	Width of tape
7147-5	0-5m	1mm	19mm

graduation

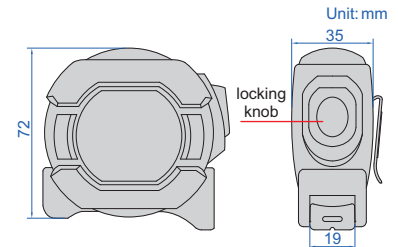

Set

Code	Range	Graduation	Width of tape	Remark
7147-5S	0-5m	1mm	19mm	include 12pcs 7147-5

MEASURING TAPES

EG II

- Non-glare nylon coating tape, wear resistance
- Accuracy: $\pm(0.3+0.2L)$ mm (L is the measured length rounded up to the next whole meter), meet MI-008 of DIRECTIVE 2014/32/EU



7142-5

graduation

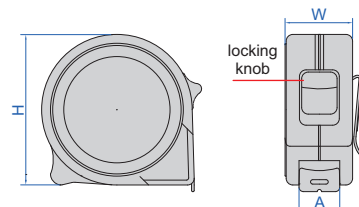

Individual (1 pc per package)

Code	Range	Graduation	Width of tape A	W	H
7142-5	0-5m/0-16ft	1mm, 1/16"	19mm	31mm	64mm

Set (12 pcs per package)

Code	Range	Graduation	Width of tape A	W	H
7142-5A	0-5m/0-16ft	1mm, 1/16"	19mm	31mm	64mm

EG II

MEASURING TAPES (ECONOMIC TYPE)



7148-5



7148-5S

- Matte coating
- Accuracy: $\pm(0.3+0.2L)$ mm (L is the measured length rounded up to the next whole meter), meet MI-008 of DIRECTIVE 2014/32/EU

Individual

Code	Range	Graduation	Width of tape
7148-5	0-5m	1mm	25mm

graduation



Set

Code	Range	Graduation	Width of tape	Remark
7148-5S	0-5m	1mm	25mm	include 12pcs 7148-5

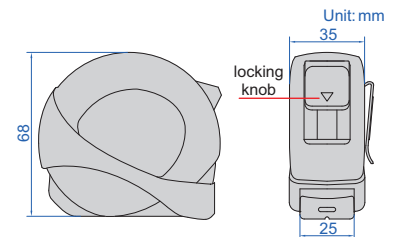

EG II

MEASURING TAPES

- Steel tape, non-glare nylon surface for wear resistance
- Accuracy: $\pm(0.3+0.2L)$ mm (L is the measured length rounded up to the next whole meter), meet MI-008 of DIRECTIVE 2014/32/EU



7149-30

Code	Range	Graduation	Width of tape (A)	W	H
7149-10	0-10m	1mm	9.5mm	41mm	107mm
7149-15	0-15m	1mm	9.5mm	41mm	107mm
7149-30	0-30m	1mm	9.5mm	41mm	107mm

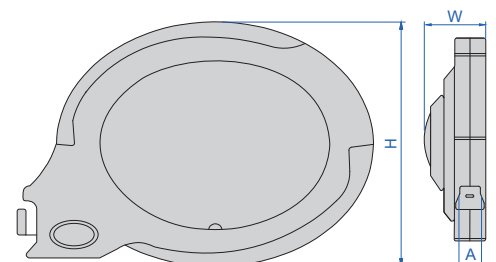

SELF ADHESIVE MEASURING ROLLS

type of reading

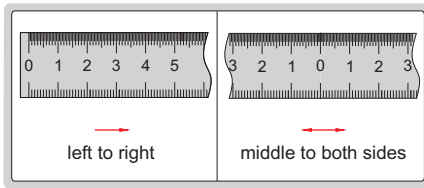

self adhesive back



- Self adhesive back
- Steel tape, non-glare coating, wear resistance

7139-50

Code	Range (L)	Graduation	Accuracy	Type of reading
7139-50	50-0-50cm	1mm	±0.2mm	middle to both sides
7139-100	0-100cm	1mm	±0.4mm	left to right

Unit: mm

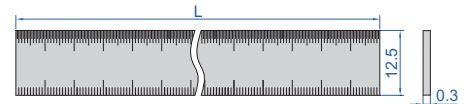

LONG MEASURING TAPE

graduation

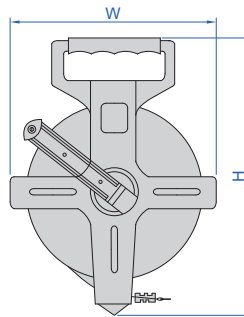
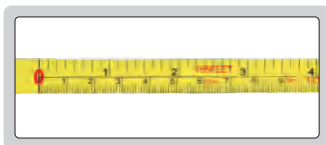

- High tensile strength fibreglass tape
- Nylon coating tape, wear resistance
- Accuracy: $\pm(0.3+0.2L)$ mm (L is the measured length rounded up to the next whole meter), meet MI-008 of DIRECTIVE 2014/32/EU

EG II



7143-50

Code	Range	Graduation	Width of tape	W	H
7143-50	0-50m/0-165ft	1mm, 1/8"	13mm	220mm	320mm

MEASURING WHEEL (BASIC TYPE)

15

- ABS plastic frame, wear-resistant PU tire
- Three-section adjustable handle



7144-1

Unit: mm

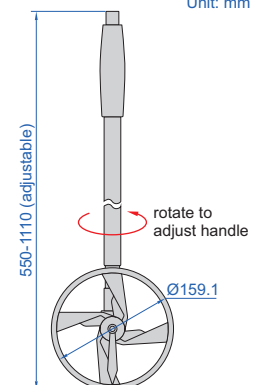

Code	Range	Resolution
7144-1	0.1-9999.9m	0.1m

MEASURING WHEEL



after folding



backpack (included)

- ABS plastic frame, wear-resistant PU tire
- Two-section foldable handle



7145-1

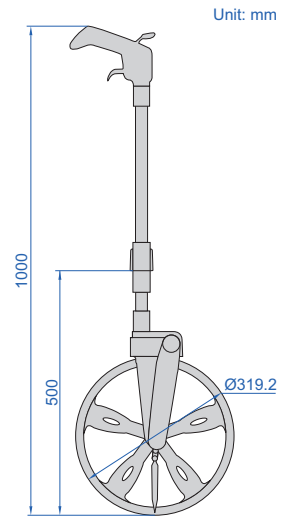

Unit: mm

Code	Range	Resolution
7145-1	0.1-9999.9m	0.1m

IP40
WATERPROOF



DIGITAL MEASURING WHEEL

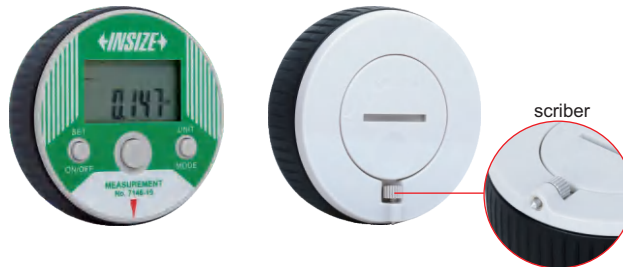

7146-10

- IP40 dust/waterproof
- Measuring length of curve
- Four measurement modes: length, rectangle area, diameter of circle, cube
- Resolution: 0.001m/0.01ft
- Button function: on/off, mm/inch, one or two sides set, measurement mode conversion, measurement
- Battery CR2032, automatic power off

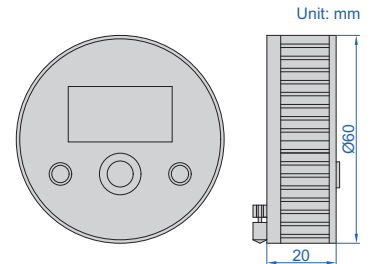

Unit: mm

Code	Range	Accuracy
7146-10	0-10m/0-32.8ft	±0.3%L (L is the measured length)

RIGID RULER



7113-300A

- Rigid ruler
- With groove on the back, suitable for combination square set (2278 series)
- Satin chrome plated



groove on the back

Code	Range	Graduation		Accuracy	L
		front	back		
7113-300A	300mm/12"	0.5mm and 1/32"	1mm and 1/64"	±0.15mm	300mm

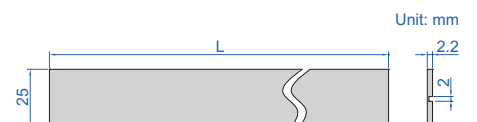

Unit: mm

POCKET RULER WITH SLIDING CLIP

- With sliding clip, clip can be inserted in the pocket, also can be used as depth gauge base
- Inch/metric conversion table on the back
- Made of stainless steel



7119-150

Unit: mm

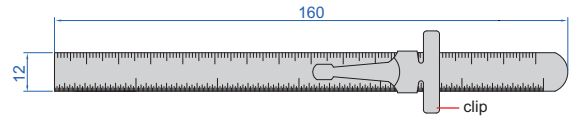

Code	Range	Graduation	Accuracy
7119-150	150mm/6"	1mm, 1/64"	±0.3mm

STEEL RULERS

- Graduation: 0.5mm, 1mm, 1/64", 1/32", 1/16"
- Rigid rulers
- Made of stainless steel
- Non-glare surface



7110-300

POPULAR MODEL

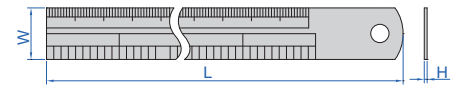

Individual (1 pc per package)

(mm)

Code	Range	Accuracy	L	W	H	Remark
7110-150	150mm/6"	±0.18mm	170	18	1.0	metric graduation on front and inch graduation on back
7110-200	200mm/8"	±0.18mm	220	18	1.0	metric graduation on front and inch graduation on back
7110-300	300mm/12"	±0.27mm	330	25	1.0	metric graduation on front and inch graduation on back
7110-3001	300mm/12"	±0.27mm	325	30	1.0	metric graduation on front and inch graduation on back
7110-500	500mm/20"	±0.40mm	530	30	1.2	metric graduation on front and inch graduation on back
7110-600	600mm/24"	±0.50mm	630	30	1.2	metric graduation on front and inch graduation on back
7110-1000	1000mm/40"	±0.50mm	1040	32	1.5	metric graduation on front and inch graduation on back
7110-1200	1200mm/48"	±0.80mm	1240	35	1.8	metric and inch graduation on front
7110-1500	1500mm/60"	±1.00mm	1550	38	1.8	metric and inch graduation on front
7110-2000	2000mm/80"	±1.00mm	2065	40	2.0	metric and inch graduation on front

Set

(mm)

Code	Range	Accuracy	L	W	H	Remark	Quantity per package
7110-150A	150mm/6"	±0.18mm	170	18	1.0	metric graduation on front and inch graduation on back	10 pcs
7110-200A	200mm/8"	±0.18mm	220	18	1.0	metric graduation on front and inch graduation on back	10 pcs
7110-300A	300mm/12"	±0.27mm	330	25	1.0	metric graduation on front and inch graduation on back	5 pcs
7110-3001A	300mm/12"	±0.27mm	325	30	1.0	metric graduation on front and inch graduation on back	5 pcs
7110-500A	500mm/20"	±0.40mm	530	30	1.2	metric graduation on front and inch graduation on back	5 pcs
7110-600A	600mm/24"	±0.50mm	630	30	1.2	metric graduation on front and inch graduation on back	5 pcs
7110-1000A	1000mm/40"	±0.50mm	1040	32	1.5	metric graduation on front and inch graduation on back	5 pcs
7110-1200A	1200mm/48"	±0.80mm	1240	35	1.8	metric and inch graduation on front	5 pcs
7110-1500A	1500mm/60"	±1.00mm	1550	38	1.8	metric and inch graduation on front	5 pcs
7110-2000A	2000mm/80"	±1.00mm	2065	40	2.0	metric and inch graduation on front	5 pcs

ALUMINUM RULERS

- Made of aluminum, oxidized surface

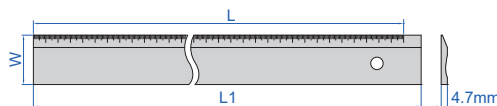

Code	Range (L)	Graduation	Accuracy	L1	W
7123-300	300mm	1mm	±0.5mm	321mm	50mm
7123-600	600mm	1mm	±0.9mm	624mm	50mm
7123-1000	1000mm	1mm	±0.9mm	1024mm	50mm



7123-300

DATA
OUTPUT

DIGITAL SCALES WITH MICROSCOPE



7100-500

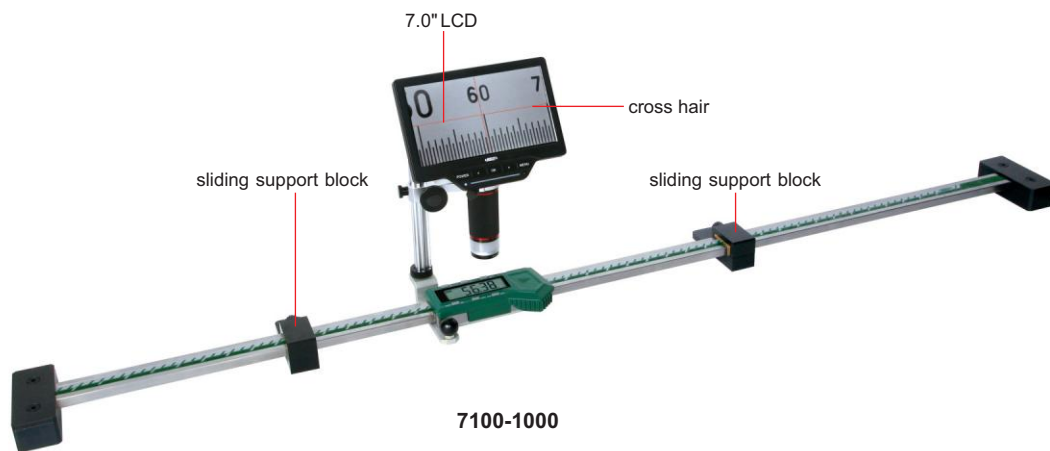

7100-1000

- Including microscope
- Optional accessory:
wireless transmitter code **7315-22** (receiver is needed) page 5,
bluetooth transmitter code **7214-22** page 11

Code	Range	Accuracy	Total length	Remark
7100-400	350mm	±0.05mm	590mm	without sliding support blocks
7100-500	450mm	±0.05mm	690mm	
7100-600	500mm	±0.08mm	790mm	with sliding support blocks
7100-800	700mm	±0.10mm	990mm	
7100-1000	900mm	±0.10mm	1240mm	

SPECIFICATION OF DIGITAL SCALE

Resolution	0.01mm/0.0005"
Buttons	on/off, zero, mm/inch, ABS, data preset
Data output	Micro USB
Power supply	Battery CR2032

SPECIFICATION OF MICROSCOPE

Display resolution	1024×600
Sensor	1/3" CMOS
Single pixel size	2µm×2µm
Magnification	1X~16X
Power supply	built-in lithium battery

COMBINATION SQUARE (ECONOMIC TYPE)

- Square head (made of zinc):
set the blade at 90° or 45° to an edge of a workpiece
accuracy: ±0.5°
- Blade (made of stainless steel):
range: 300mm/12",
graduation: 1mm and 1/32" on front face,
1mm and 1/16" on back face



2276-300

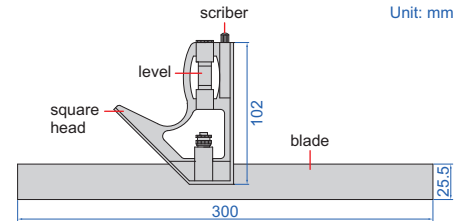
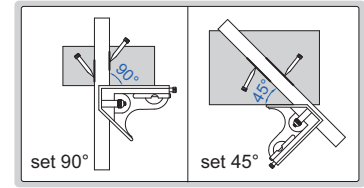

Code

2276-300

COMBINATION SQUARE SET (OPEN TYPE PROTRACTOR)

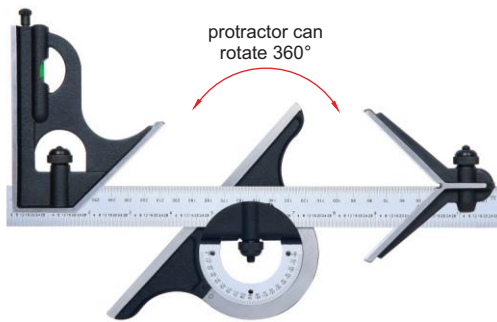

2274-4

protractor can rotate 360°

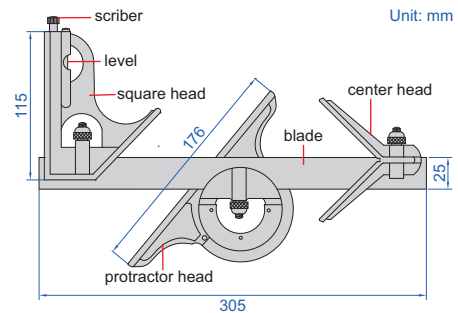

- Center head (made of cast iron):
to locate center of cylinders with diameter (Ød): 30-100mm
accuracy: ±0.15mm
- Protractor head (made of cast iron):
set the blade at desired angle to an edge of a workpiece, and can be used to measure angles
range: 0-180°
accuracy: ±20min
- Square head (made of cast iron):
set the blade at 90° or 45° to an edge of a workpiece
accuracy: ±8min for 90° square,
±10min for 45° square
- Blade (made of stainless steel):
range: 300mm/12",
graduation: 0.5mm and 1/32" on front face,
1mm and 1/64" on back face
- Optional accessory: rigid ruler (code 7113)

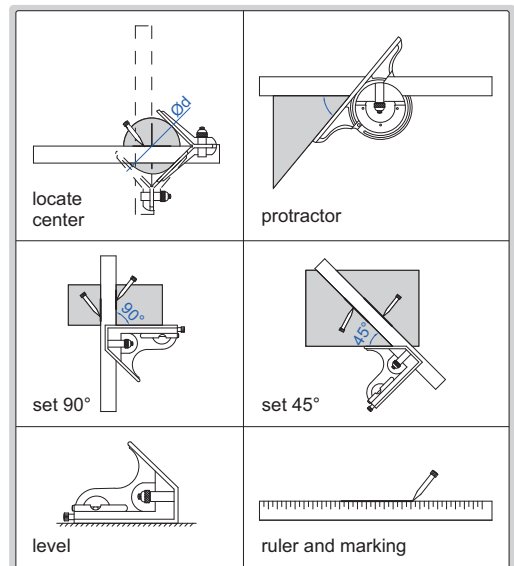

Code

2274-4

Remark

4-piece set

COMBINATION SQUARE SETS (CLOSE TYPE PROTRACTOR)



2278-2



2278-3



2278-180

- Center head (made of cast iron):
to locate center of cylinders with diameter (\varnothing d): 30-100mm
accuracy: ± 0.15 mm
- Protractor head (made of cast iron):
set the blade at desired angle to an edge of a workpiece,
and can be used to measure angles
range: 0-180°
accuracy: ± 20 min.
- Square head (made of cast iron):
set the blade at 90° or 45° to an edge of a workpiece
accuracy: ± 8 min for 90° square,
 ± 10 min for 45° square
- Blade (made of stainless steel):
range: 300mm/12",
graduation: 0.5mm and 1/32" on front face,
1mm and 1/64" on back face
- Optional accessory: rigid ruler (code 7113)

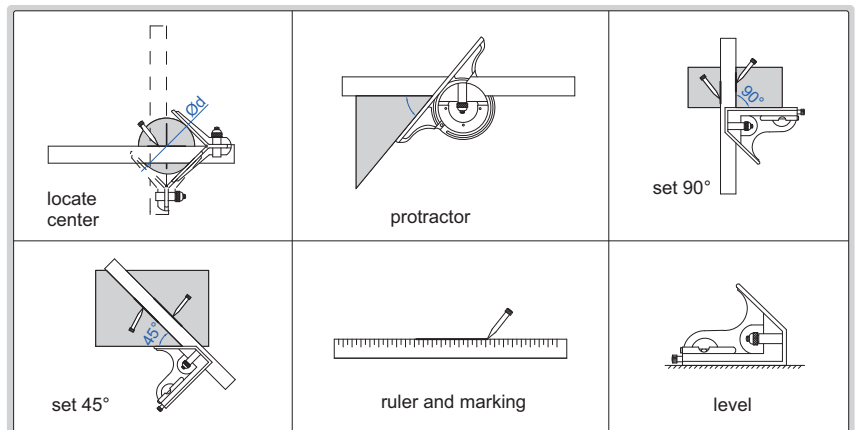
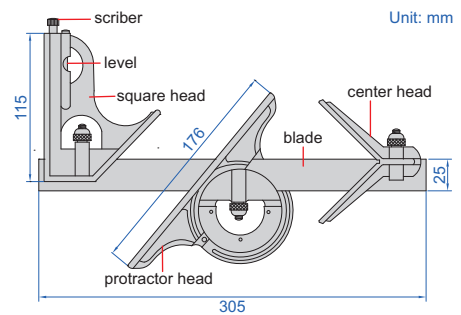

Code	Remark
2278-2	2-piece set
2278-3	3-piece set
2278-180	4-piece set

PLASTIC ANGLE SQUARE



2282-180

- Length range: 0-7", graduation: 1/8"
- Angel range: 0-90°, graduation: 1°

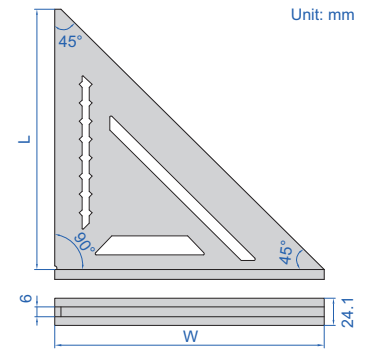

Code	Size (L×W)	Accuracy of angle
2282-180	180×185mm	±0.3°

T-BEVEL

blade can rotate 360°

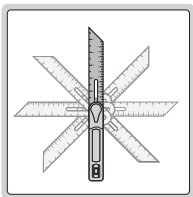

2281-360

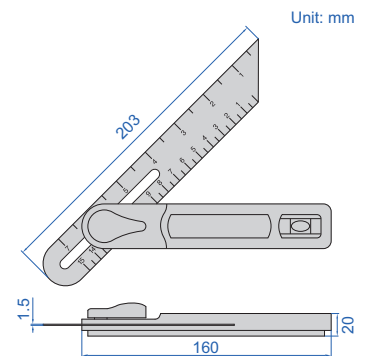

- Easy-to-read vial
- The blade can move and can be locked by the clamping screw
- Stainless steel blade
- Tough rubber handle
- Centimeter/inch graduations

Code	Angle mark	Accuracy of angle
2281-360	15°, 30°, 45°, 60°, 90°	±1°

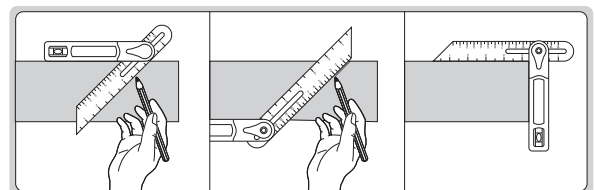

MARKING GAUGES



7120-200A

- Made of carbon steel
- Stainless steel chrome plated

Code	Range	Graduation	Accuracy	L	W
7120-200A	0-200mm	0.1mm	±0.1mm	250mm	40mm
7120-250A	0-250mm	0.1mm	±0.1mm	300mm	40mm
7120-300A	0-300mm	0.1mm	±0.1mm	350mm	40mm

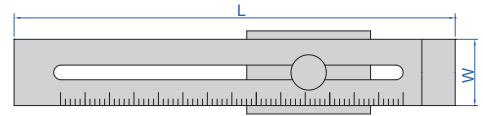
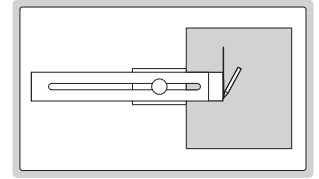

T-SHAPE MARKING GAUGE



1275-150B

- Made of stainless steel
- Satin chrome plated reading surface

Code	Range	Graduation	Accuracy
1275-150B	0-150mm	0.02mm	±0.04mm

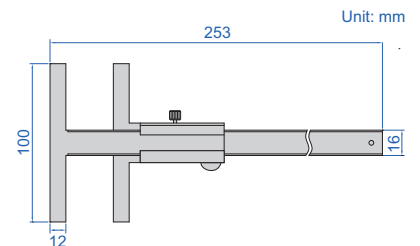
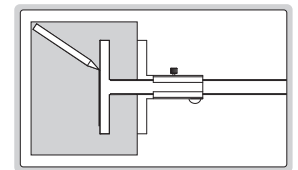

CENTER MARKING GAUGES



7205-100

- Marking the center of round plates and shafts
- Made of stainless steel
- Satin chrome plated

Code	Size (AxB)	Diameter of shafts (Ød)	Accuracy	C	L
7205-100	100x70mm	4-90mm	±0.15mm	12mm	153mm
7205-150	150x130mm	4-190mm	±0.15mm	15mm	245mm
7205-200	200x150mm	6-220mm	±0.15mm	15mm	310mm
7205-300	300x180mm	6-270mm	±0.15mm	20mm	435mm

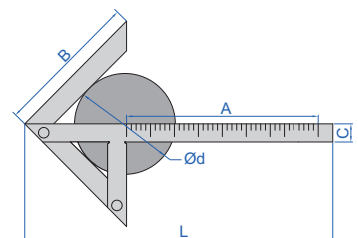
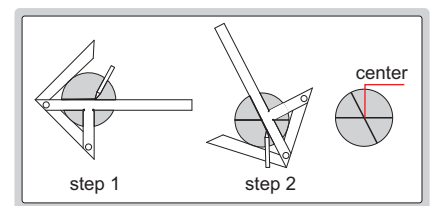

SCRIBING CALIPER

- Made of stainless steel
- Satin chrome plated reading surface
- Carbide scriber tip
- Optional accessory: carbide scriber tip (code **SP-SCRIBER-7202**)

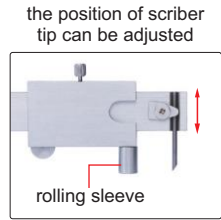

7202-200A

Code	Range	Graduation	Accuracy
7202-200A	0-200mm/0-8"	0.1mm, 1/128"	±0.1mm

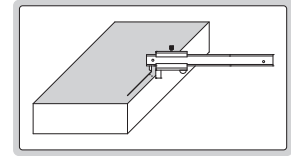
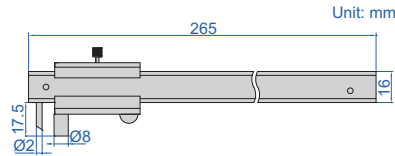

DIGITAL SCRIBING CALIPER

- Non waterproof
- The carbide-tipped jaws facilitate scribing on workpieces
- Resolution: 0.01mm/0.0005"
- Buttons: on/off, zero, mm/inch
- Automatic power off, move the digital unit to turn on power
- Battery CR2032
- Made of stainless steel



1166-150A

Code	Range	Accuracy
1166-150A	0-150mm/0-6"	±0.03mm

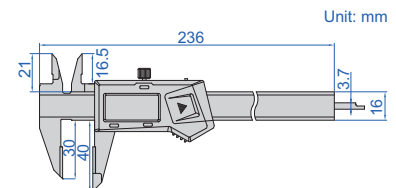
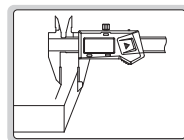

15

SCRIBING CALIPER

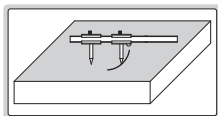

- Made of stainless steel
- Satin chrome plated reading surface
- Hardened scriber tips



7203-300A

Code	Range	Graduation	Accuracy
7203-300A	51-300mm	0.1mm	±0.1mm

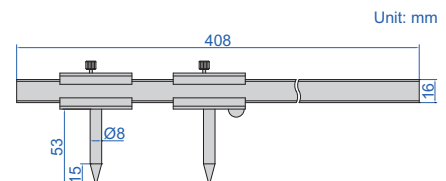

HEIGHT SCRIBER

- Grooved bottom for cylinders
- Two pins to be set against the edge of surface plate

Code
6990-300A

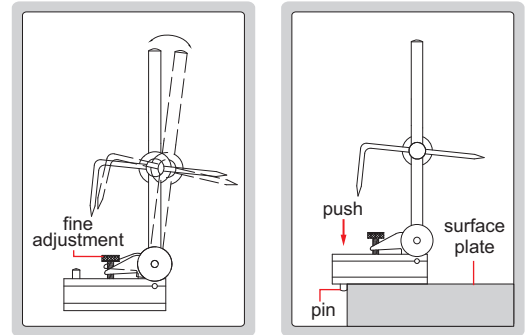
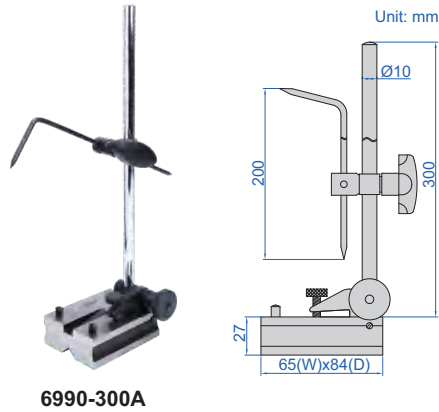

6990-300A

SCRIBERS

- 7230 and 7231 are nickel plated, 7232 is zinc-plated

Code	Tip
7230	hardened tips
7231	hardened tip
7232	carbide tip

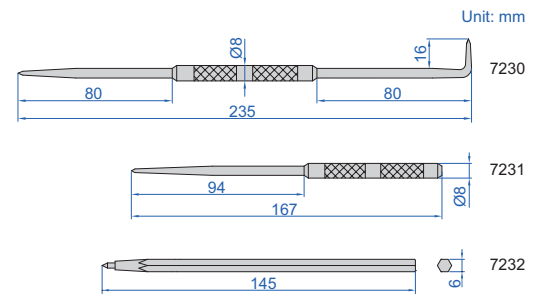

7230

7231

7232

clip

PRECISION SCREWDRIVER SET
CODE ISGF-0901

- Includes:
4pcs "-": 1.4mm, 2.0mm, 2.4mm, 3.0mm
2pcs "+": 0#, 1#
- Rotating cap
- Material: CRV, hardness: HRC52~56



ISGF-0901

packaging



LED FLASHLIGHT
CODE ISGF-0501

- Toshiba high performance LED
- Powered by 3x AAA batteries (batteries are not included)
- Max output: 120 lumens
- Battery life: 4 hours
- Beam distance: 70 meters
- IP54 dust/waterproof

packaging



ISGF-0501

MEASURING TOOLS REPAIR TOOL SET

- For repairing of calipers, micrometers and indicators
- Including:
 - 1) Slotted screwdriver, 1.4×20mm
 - 2) Slotted screwdriver, 2.0×20mm
 - 3) Slotted screwdriver, 2.4×25mm
 - 4) Slotted screwdriver, 3.0×25mm
 - 5) Cross screwdriver, 0#×25mm
 - 6) Cross screwdriver, 1#×25mm
 - 7) Magnetizer and demagnetizer
 - 8) Pointed tweezers, 125mm
 - 9) Mini needle-nose pliers, 5"
 - 10) Extended flat head allen wrench, 1.5×80mm
 - 11) Extended flat head allen wrench, 2.5×94mm
 - 12) Extended flat head allen wrench, 3×92mm
 - 13) Needle puller, 3 pcs
 - 14) Copper hammer, 126g
 - 15) Copper rod, Ø10×60mm
 - 16) Dial face suction cup, Ø30mm
 - 17) Oil stone, 100×20×10mm
 - 18) Cleaning brush
 - 19) Micrometer wrench
 - 20) Three point inside micrometer rod wrench, 2 pcs
 - 21) Anti rust oil, 30ml
 - 22) Special anti rust oil for micrometers, 30ml
 - 23) Dust free cloth, 5 pcs



7338-1

Code

7338-1

2-PIECE MEASURING TOOL SETS

- Includes:
 - 1) Vernier caliper, range 0-150mm/0-6", graduation 0.05mm/1/128" (code **1205-150S**) for **5021**, graduation 0.02mm/0.001" (code **1205-1502S**) for **5021-2**
 - 2) Outside micrometer, range 0-25mm, graduation 0.01mm (code **3202-25A**)

Code	Remark
5021	vernier caliper, graduation 0.05mm/1/128" (code 1205-150S)
5021-2	vernier caliper, graduation 0.02mm/0.001" (code 1205-1502S)



5021

15

2-PIECE MEASURING TOOL SETS

- Includes:
 - 1) Digital caliper, range 0-150mm/0-6", resolution 0.01mm/0.0005", with thumb roller (code **1108-150**) for **5022**, without thumb roller (code **1108-150W**) for **5022-W**
 - 2) Digital outside micrometer, range 0-25mm/0-1", resolution 0.001mm/0.00005" (code **3109-25A**)

Code	Remark
5022	digital caliper, with thumb roller, code 1108-150
5022-W	digital caliper, without thumb roller, code 1108-150W



5022

2-PIECE MEASURING TOOL SET

- Includes:
 - 1) Dial test indicator, range 0.8mm, graduation 0.01mm (code **2380-08**)
 - 2) Magnetic stand

Code
5023



5023

2-PIECE MEASURING TOOL SET

- Includes:
 - 1) Dial indicator, range 10mm, graduation 0.01mm (code **2308-10A**)
 - 2) Magnetic stand (code **6201-60**)

Code
5024



5024

3-PIECE MEASURING TOOL SET

- Includes:
 - 1) Digital indicator, range 12.7mm/0.5", resolution 0.01mm/0.0005" (code **2112-10**)
 - 2) Flex arm
 - 3) Locking pliers, adjustable jaw opening from 0 to 25mm



Code
5031



5031

3-PIECE MEASURING TOOL SET

■ Includes:

- 1) Vernier caliper, range 0-150mm graduation 0.02mm (code **1205-1501S**)
- 2) Outside micrometer, range 0-25mm, graduation 0.01mm (code **3203-25A**)
- 3) Steel ruler, range 150mm/6", graduation 0.5mm, 1mm, 1/64", 1/32", 1/16" (code **7110-150**)
- 4) Dust free gloves and dust free cloth



5032

Code

5032

4-PIECE MEASURING TOOL SETS

■ Includes:

- 1) Vernier caliper, range 0-150mm/0-6", graduation 0.05mm/1/128" (code **1205-150S**) for **5041**, graduation 0.02mm/0.001" (code **1205-1502S**) for **5041-2**
- 2) Outside micrometer, range 0-25mm, graduation 0.01mm (code **3202-25A**)
- 3) 90° beveled edge square, 100x70mm, grade 0 (code **4790-1000**)
- 4) Steel ruler, 150mm/6" (code **7110-150**)



5041

Code

Remark

5041 vernier caliper, graduation 0.05mm/1/128" (code **1205-150S**)

5041-2 vernier caliper, graduation 0.02mm/0.001" (code **1205-1502S**)

4-PIECE MEASURING TOOL SETS

■ Includes:

- 1) Digital caliper, range 0-150mm/0-6", resolution 0.01mm/0.0005", with thumb roller (code **1108-150**) for **5042**, without thumb roller (code **1108-150W**) for **5042-W**
- 2) Outside micrometer, range 0-25mm, graduation 0.01mm, (code **3202-25A**)
- 3) 90° beveled edge square, 100x70mm, grade 0 (code **4790-1000**)
- 4) Steel ruler, 150mm/6" (code **7110-150**)

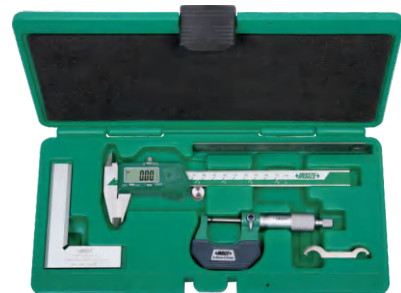

5042

Code

Remark

5042 digital caliper, with thumb roller, code **1108-150**

5042-W digital caliper, without thumb roller, code **1108-150W**

5-PIECE MEASURING TOOL SETS

■ Includes:

- 1) Digital caliper, range 0-150mm/0-6", resolution 0.01mm/0.0005", with thumb roller (code **1108-150**) for **5051**, without thumb roller (code **1108-150W**) for **5051-W**
- 2) Outside micrometer, range 0-25mm, graduation 0.01mm (code **3203-25A**)
- 3) Dial indicator, range 10mm, graduation 0.01mm (code **2308-10A**)
- 4) Magnetic stand (code **6201-60**)
- 5) Micrometer stand (code **6300**)

Code	Remark
5051	digital caliper, with thumb roller, code 1108-150
5051-W	digital caliper, without thumb roller, code 1108-150W



5051

5-PIECE MEASURING TOOL SETS

■ Includes:

- 1) Digital caliper, range 0-150mm/0-6", resolution 0.01mm/0.0005", with thumb roller (code **1108-150**) for **5052**, without thumb roller (code **1108-150W**) for **5052-W**
- 2) Digital outside micrometer, range 0-25mm/0-1", resolution 0.001mm/0.00005" (code **3109-25A**)
- 3) Digital indicator, range 12.7mm/0.5", resolution 0.01mm/0.0005" (code **2112-10**)
- 4) Magnetic stand (code **6201-60**)
- 5) Micrometer stand (code **6300**)

Code	Remark
5052	digital caliper, with thumb roller, code 1108-150
5052-W	digital caliper, without thumb roller, code 1108-150W



5052

6-PIECE MEASURING TOOL SETS

■ Includes:

- 1) Digital caliper, range 0-150mm/0-6", resolution 0.01mm/0.0005", with thumb roller (code **1108-150**) for **5061**, without thumb roller (code **1108-150W**) for **5061-W**
- 2) Outside micrometer, range 0-25mm, graduation 0.01mm (code **3202-25A**)
- 3) Dial indicator, range 10mm, graduation 0.01mm (code **2308-10FA**)
- 4) 90° beveled edge square, 100x70mm, grade 0 (code **4790-1000**)
- 5) Scriber (code **7230**)
- 6) Steel ruler, 150mm/6" (code **7110-150**)

Code	Remark
5061	digital caliper, with thumb roller, code 1108-150
5061-W	digital caliper, without thumb roller, code 1108-150W



5061

6-PIECE MEASURING TOOL SETS

■ Includes:

- 1) Digital caliper, range 0-150mm/0-6" resolution 0.01mm/0.0005", with thumb roller (code **1108-150**) for **5062**, without thumb roller (code **1108-150W**) for **5062-W**
- 2) Outside micrometer, range 0-25mm graduation 0.01mm (code **3202-25A**)
- 3) 90° beveled edge square, 100x70mm grade 00 (code **4790-0100**)
- 4) Straight edge, 100mm (code **4700-100**)
- 5) Spring divider, 150mm (code **7260-150**)
- 6) Steel ruler, 200mm/8" (code **7110-200**)

Code	Remark
5062	digital caliper, with thumb roller, code 1108-150
5062-W	digital caliper, without thumb roller, code 1108-150W



5062

6-PIECE MEASURING TOOL SETS

■ Includes:

- 1) Vernier caliper, range 0-150mm/0-6", graduation 0.05mm/1/128" (code **1205-150S**) for **5063**, graduation 0.02mm/0.001" (code **1205-1502S**) for **5063-2**
- 2) Outside micrometer, range 0-25mm graduation 0.01mm (code **3202-25A**)
- 3) 90° beveled edge square, 100x70mm grade 00 (code **4790-0100**)
- 4) Straight edge, 100mm (code **4700-100**)
- 5) Spring divider, 150mm (code **7260-150**)
- 6) Steel ruler, 200mm/8" (code **7110-200**)

Code	Remark
5063	vernier caliper, graduation 0.05mm/1/128" (code 1205-150S)
5063-2	vernier caliper, graduation 0.02mm/0.001" (code 1205-1502S)



5063

8-PIECE MEASURING TOOL SETS

■ Includes:

- 1) Digital caliper, range 0-150mm/0-6", resolution 0.01mm/0.0005", with thumb roller (code **1108-150**) for **5081**, without thumb roller (code **1108-150W**) for **5081-W**
- 2) Digital outside micrometer, range 0-25mm/0-1", graduation 0.001mm/0.00005" (code **3109-25A**)
- 3) Dial test indicator, range 0.8mm, graduation 0.01mm (code **2380-08**)
- 4) Magnetic stand (code **6201-60**)
- 5) Parallel/square set, 75x50x25mm (code **6531-25**)
- 6) Steel ruler, 150mm/6" (code **7110-150**)
- 7) Depth base attachment (code **6140**)
- 8) Zero setting bar for depth base attachment

Code	Remark
5081	digital caliper, with thumb roller, code 1108-150
5081-W	digital caliper, without thumb roller, code 1108-150W



5081

9-PIECE MEASURING TOOL SETS

■ Includes:

- 1) Digital caliper, range 0-150mm/0-6", resolution 0.01mm/0.0005", with thumb roller (code **1108-150**) for **5091**, without thumb roller (code **1108-150W**) for **5091-W**
- 2) Outside micrometer, range 0-25mm, graduation 0.01mm (code **3202-25A**)
- 3) Protractor, range 0-180°, graduation 1° (code **4799-180**)
- 4) Pitch gauge, range 0.25-7mm, 24 pcs, metric 60° thread (code **4820-124**)
- 5) Radius gauge, range 1-7mm (code **4801-17**)
- 6) Feeler gauge, range 0.05-1.00mm, 20 pcs (code **4602-20**)
- 7) 90° beveled edge square, 100x70mm, grade 0 (code **4790-1000**)
- 8) Scriber (code **7230**)
- 9) Steel ruler, 150mm/6" (code **7110-150**)



5091

Code	Remark
5091	digital caliper, with thumb roller, code 1108-150
5091-W	digital caliper, without thumb roller, code 1108-150W

13-PIECE MEASURING TOOL SETS

■ Includes:

- 1) Digital caliper, range 0-150mm/0-6", resolution 0.01mm/0.0005", with thumb roller (code **1108-150**) for **5013**, without thumb roller (code **1108-150W**) for **5013-W**
- 2) Outside micrometer, range 0-25mm, graduation 0.01mm (code **3202-25A**)
- 3) Dial indicator, range 10mm, graduation 0.01mm (code **2308-10A**)
- 4) Magnetic stand (code **6201-60**)
- 5) Protractor, range 0-180°, graduation 1° (code **4799-180**)
- 6) Pitch gauge, range 0.25-7mm, 24 pcs, metric 60° thread (code **4820-124**)
- 7) Radius gauge, range 1-7mm (code **4801-17**)
- 8) Feeler gauge, range 0.05-1.00mm, 20 pcs (code **4602-20**)
- 9) 90° beveled edge square, 100x70mm, grade 0 (code **4790-1000**)
- 10) Scriber (code **7230**)
- 11) Steel ruler, 150mm/6" (code **7110-150**)
- 12) Depth base attachment (code **6140**)
- 13) Zero setting bar for depth base attachment



5013

Code	Remark
5013	digital caliper, with thumb roller, code 1108-150
5013-W	digital caliper, without thumb roller, code 1108-150W



Granite Surface Plates
Page 489



Stands For Granite Surface Plates
Page 490



Jack Sets For Granite Surface Plates
Page 490



Magnetic Rectangular Blocks
Page 491



V-blocks
Page 491-495



Magnetic V-blocks
Page 495-497

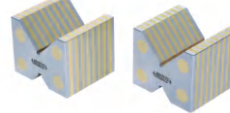

Magnetic Induction V-blocks
Page 497

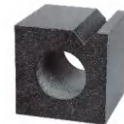

Squares With V Groove
Page 498

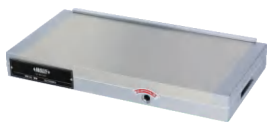

Permanent Magnetic Chucks
Page 499



Parallels
Page 500-502



Parallel/Square Sets
Page 503

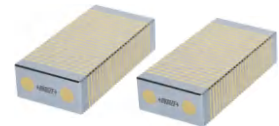

Magnetic Induction Parallel Sets
Page 503



Angle Plate Sets
Page 503-504



Adjustable Angle Blocks
Page 504

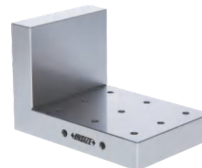

Right Angle Plates
Page 504-505



Sine Bars
Page 505-506



Sine Tables
Page 506-507



Precision Sine Vises
Page 507-508



Precision Vises
Page 508-509



Precision Universal Vises
Page 509-510



Anvil Vises
Page 510



Stages
Page 511-514

GRANITE SURFACE PLATES



CUSTOM-MADE
SUPPLY SPECIAL SIZES ACCORDING
TO CUSTOMER'S REQUEST

- Made of Indian granite, high hardness, free from deterioration or dimensional change over time, minimal changes in dimension due to temperature changes
- Meet DIN876, grade 00 is for inspection room or lab, grade 0 is for workshop
- Optional accessory:
stand for granite surface plate (code **6902**),
jack for granite surface plate (code **6903**)



6900-132

Physical characteristics of granite

Shore hardness	94HS
Flexural strength	28MPa
Compressive strength	236MPa
Elastic modulus	9.88×10 ⁴ MPa
Poisson's ratio	0.33
Volume density	3000kg/m ³
Water absorption rate	0.05%
Linear expansion coefficient	6×10 ⁻⁶ /°C

Grade 00

Code	Size (L×W×H)	Flatness	Weight	Max. load
6900-132*	300×200×60mm	2.7µm	11kg	30kg
6900-142*	400×250×60mm	2.9µm	18kg	50kg
6900-144*	400×400×60mm	3.1µm	29kg	60kg
6900-153*	500×315×70mm	3.2µm	33kg	60kg
6900-164*	630×400×80mm	3.5µm	60kg	65kg
6900-166*	630×630×100mm	3.8µm	119kg	75kg
6900-185*	800×500×100mm	3.9µm	120kg	100kg
6900-1106*	1000×630×140mm	4.4µm	265kg	200kg
6900-1107*	1000×750×150mm	4.5µm	337kg	300kg
6900-1101*	1000×1000×150mm	4.8µm	450kg	400kg
6900-1128*	1200×800×160mm	4.9µm	461kg	500kg
6900-1161*	1600×1000×180mm	5.8µm	864kg	600kg
6900-1201*	2000×1000×220mm	6.5µm	1320kg	650kg
6900-1202*	2000×1500×250mm	7.0µm	2250kg	750kg



Grade 0

Code	Size (L×W×H)	Flatness	Weight	Max. load
6900-032*	300×200×60mm	5.4µm	11kg	60kg
6900-042*	400×250×60mm	5.9µm	18kg	100kg
6900-044*	400×400×60mm	6.3µm	29kg	120kg
6900-053*	500×315×70mm	6.4µm	33kg	120kg
6900-064*	630×400×80mm	7.0µm	60kg	130kg
6900-066*	630×630×100mm	7.6µm	119kg	150kg
6900-085*	800×500×100mm	7.8µm	120kg	200kg
6900-0106*	1000×630×140mm	8.7µm	265kg	400kg
6900-0107*	1000×750×150mm	9.0µm	337kg	600kg
6900-0101*	1000×1000×150mm	9.7µm	450kg	800kg
6900-0128*	1200×800×160mm	9.8µm	461kg	1000kg
6900-0161*	1600×1000×180mm	11.5µm	864kg	1200kg
6900-0201*	2000×1000×220mm	12.9µm	1320kg	1300kg
6900-0202*	2000×1500×250mm	14.0µm	2250kg	1500kg

* Supplied with manufacturer inspection certificate

STANDS FOR GRANITE SURFACE PLATES

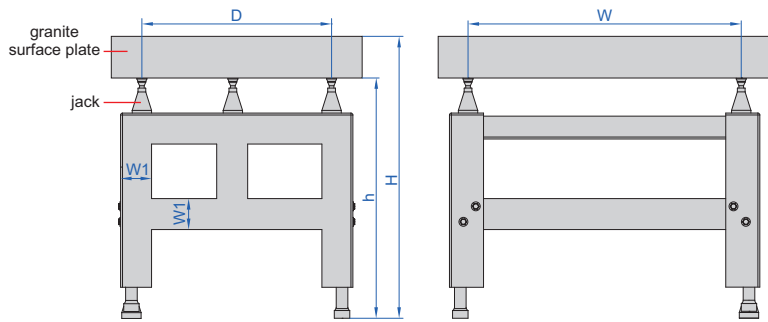

6902-64A

- For medium size granite surface plates
- 5 jacks are included
- Adjusting range of jacks: 25mm
- One foot on the bottom is adjustable

Low stands

(mm)

Code	For granite surface plate	W	D	H (with granite surface plate)	h (without granite surface plate)	W1
6902-64A	630×400×80mm (code 6900-064 and 6900-164)	352	224	775-800	695-720	80
6902-66A	630×630×100mm (code 6900-066 and 6900-166)	352	352	775-800	675-700	80
6902-85A	800×500×100mm (code 6900-085 and 6900-185)	448	280	775-800	675-700	80
6902-106A	1000×630×140mm (code 6900-0106 and 6900-1106)	560	352	755-780	615-640	80
6902-107A	1000×750×150mm (code 6900-0107 and 6900-1107)	560	420	755-780	605-630	80
6902-101A	1000×1000×150mm (code 6900-0101 and 6900-1101)	560	560	755-780	605-630	80
6902-128A	1200×800×160mm (code 6900-0128 and 6900-1128)	672	448	755-780	595-620	80
6902-161A	1600×1000×180mm (code 6900-0161 and 6900-1161)	896	560	755-780	575-600	100
6902-201A	2000×1000×220mm (code 6900-0201 and 6900-1201)	1120	560	755-780	535-560	100
6902-202A	2000×1500×250mm (code 6900-0202 and 6900-1202)	1120	840	755-780	505-530	100

High stands

(mm)

Code	For granite surface plate	W	D	H (with granite surface plate)	h (without granite surface plate)	W1
6902-64H	630×400×80mm (code 6900-064 and 6900-164)	352	224	1000-1025	920-945	80
6902-66H	630×630×100mm (code 6900-066 and 6900-166)	352	352	1000-1025	900-925	80
6902-85H	800×500×100mm (code 6900-085 and 6900-185)	448	280	1000-1025	900-925	80
6902-106H	1000×630×140mm (code 6900-0106 and 6900-1106)	560	352	1000-1025	860-885	80
6902-107H	1000×750×150mm (code 6900-0107 and 6900-1107)	560	420	1000-1025	850-875	80
6902-101H	1000×1000×150mm (code 6900-0101 and 6900-1101)	560	560	1000-1025	850-875	80
6902-128H	1200×800×160mm (code 6900-0128 and 6900-1128)	672	448	1000-1025	840-865	80
6902-161H	1600×1000×180mm (code 6900-0161 and 6900-1161)	896	560	1000-1025	820-845	100
6902-201H	2000×1000×220mm (code 6900-0201 and 6900-1201)	1120	560	1000-1025	780-805	100
6902-202H	2000×1500×250mm (code 6900-0202 and 6900-1202)	1120	840	1000-1025	750-775	100

JACK SET FOR GRANITE SURFACE PLATES

16

- 5 jacks per set
- Adjustable height
- For large granite surface plates:
2000×1000×220mm
(code 6900-0201 and 6900-1201)
2000×1500×250mm
(code 6900-0202 and 6900-1202)

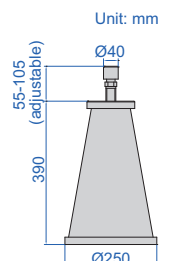

6903-B

Code

6903-B

MAGNETIC RECTANGULAR BLOCKS

HARDENED SURFACES

HIGH PRECISION

STRONG MAGNETIC FORCE

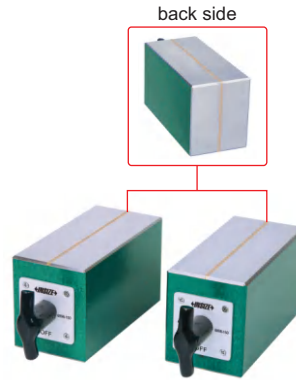
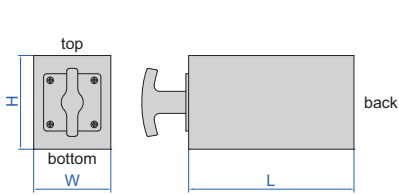

6898-150

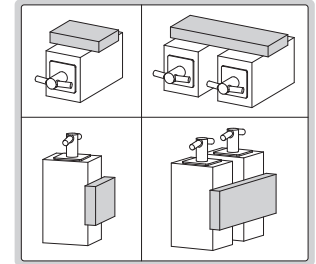

- For grinding, light milling, drilling and inspection of round and square jobs
- Hardened, high accuracy, strong magnetic force
- Working surfaces are hardened to HRC58-62
- Magnetic force on top, bottom and back sides
- Supplied in matched pair

Code	Size (L×W×H)	Magnetic force	Parallelism of top to bottom side	Squareness of top and bottom to back side	Height difference of a matched pair
6898-100	100×70×70mm	100kgf	5µm	5µm	5µm
6898-150	150×70×85mm	125kgf	5µm	5µm	5µm

V-BLOCK SETS



6896-10

6896-11

16

- Hold cylindrical workpieces for inspection and machining
- Two V-blocks per set
- Made of alloy steel
- Hardened to HRC60±2
- V groove on the top for large shafts
- V groove on the bottom for small shafts (except 6896-10)

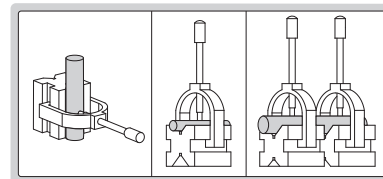

Code	Size (L×W×H)	Range of shafts (Ød)	Parallelism of both V grooves to top and bottom sides	Squareness of both V grooves to front and back sides	Height difference of a matched pair
6896-10	25×20×20mm	3-20mm	3µm	3µm	3µm
6896-11	50×40×40mm	5-30mm	5µm	5µm	5µm
6896-12	80×63×63mm	7-63mm	5µm	5µm	5µm
6896-13	100×80×80mm	7-80mm	5µm	5µm	5µm
6896-14	70×140×140mm	9-140mm	5µm	5µm	5µm

SIDE LIE-DOWN
USE IS POSSIBLE

V-BLOCK SET



6802-1

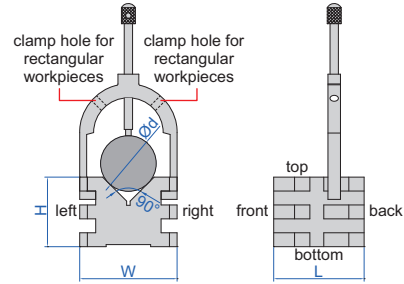

- Hold cylindrical or rectangular workpieces for inspection and machining
- Two V-blocks per set
- Made of alloy steel
- Hardened to HRC60±2
- Applicable for rectangular workpieces with thickness: ≤35mm

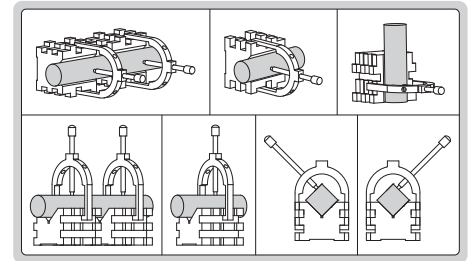

Code	Size (L×W×H)	Range of shafts (Ød)	Parallelism of V groove to top, bottom, left, right sides	Squareness of V groove to front and back sides	Height difference of a matched pair
6802-1	65×70×50mm	5-50mm	5µm	5µm	5µm

SIDE LIE-DOWN
USE IS POSSIBLE

V-BLOCK SETS



6803-1

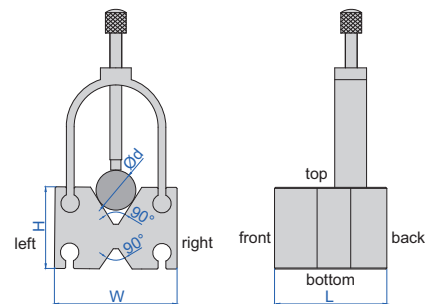

- Hold cylindrical workpieces for inspection and machining
- Two V-blocks per set
- Made of alloy steel
- Hardened to HRC60±2
- V groove on the top for large shafts
- V groove on the bottom for small shafts

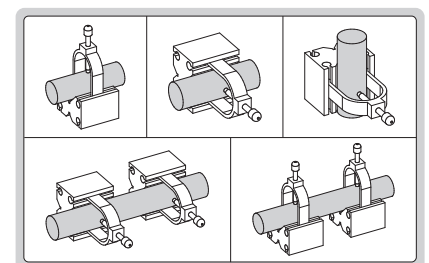

Code	Size (L×W×H)	Range of shafts (Ød)	Parallelism of both V grooves to top, bottom, left, right sides	Squareness of both V grooves to front and back sides	Height difference of a matched pair
6803-1	55×60×40mm	4-35mm	5µm	5µm	5µm
6803-2	65×70×45mm	4-47mm	5µm	5µm	5µm

V-BLOCK SET

SIDE LIE-DOWN USE IS POSSIBLE

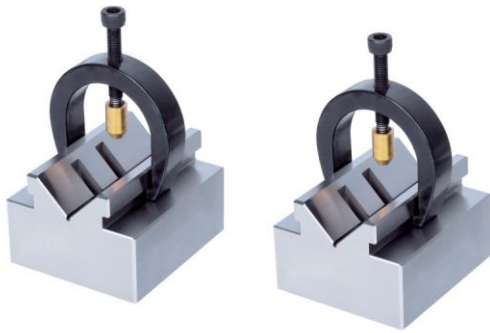

6806-20

- Hold cylindrical workpieces for inspection and machining
- Two V-blocks per set
- Made of alloy steel
- Hardened to HRC60±2
- Applicable for cylinder with diameter (Ød): 2-20mm

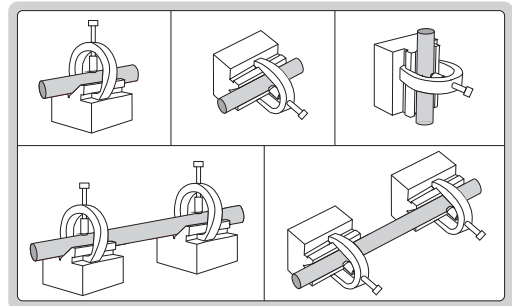
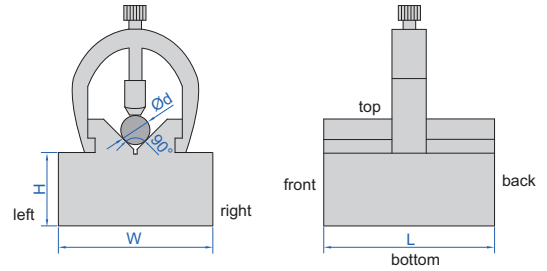

Code	Size (L×W×H)	Parallelism of V groove to bottom, left, right sides	Squareness of V groove to front and back sides	Height difference of a matched pair
6806-20	70×63×31mm	5µm	5µm	5µm

V-BLOCK

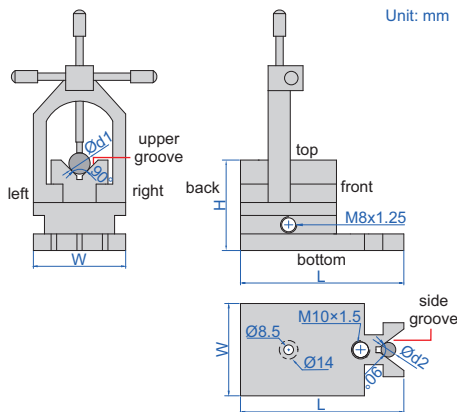

Unit: mm



6804-M2

- Hold cylindrical workpieces for inspection and machining
- Made of alloy steel
- Hardened to HRC60±2

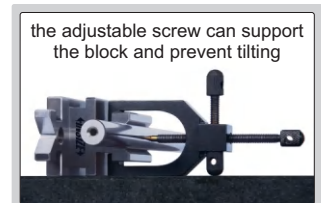

Code	Size (L×W×H)	Range of shafts (Ød1 and Ød2)	Parallelism of upper groove to bottom, left and right sides	Squareness of upper groove to back side	Parallelism of side groove to back side
6804-M2	90×48×48mm	5-33mm	5µm	5µm	5µm

V-BLOCK SETS

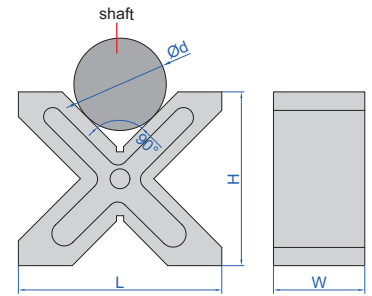
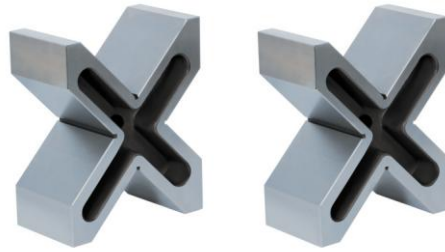
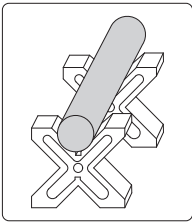

- For positioning cylindrical workpieces
- Two V-blocks per set
- Each V-block has four 90° V-grooves
- Cast iron, hardness HB170-240

6805-2

Code	Size (L×H×W)	Range of shafts (Ød)	Parallelism of four V grooves to all sides	Height difference of a matched pair
6805-1	150×130×75mm	8-120mm	15µm	20µm
6805-2	200×170×90mm	12-180mm	15µm	20µm

V-BLOCK SETS

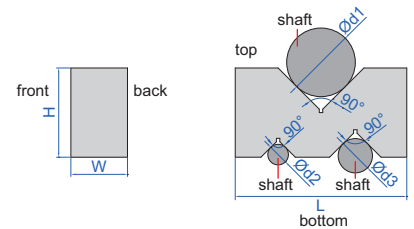
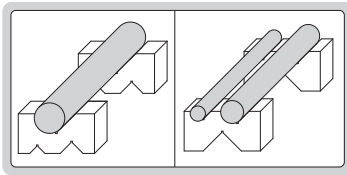

- Two V-blocks per set
- Made of hardened tool steel

6887-3

Code	Size (L×W×H)	Range of shafts (Ød1)	Range of shafts (Ød2)	Range of shafts (Ød3)
6887-1	50×19×24mm	3-32mm	3-16mm	3-22mm
6887-2	75×24×35mm	3-50mm	3-20mm	3-32mm
6887-3	100×33×52mm	3-68mm	3-26mm	3-40mm
6887-4	125×44×69mm	3-87mm	3-34mm	3-50mm

Code	Parallelism of three V grooves to top and bottom sides	Height difference of a matched pair
6887-1	5µm	5µm
6887-2	5µm	5µm
6887-3	5µm	5µm
6887-4	5µm	5µm

ROLLER BEARING V-BLOCK SETS

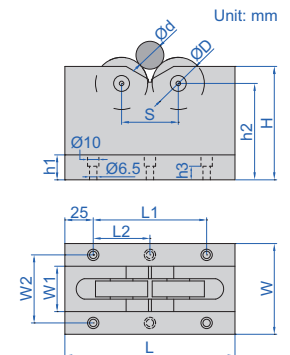
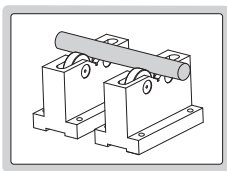

- Runout accuracy: 5µm
- Parallelism of bearings to bottom: 12µm
- Two V-blocks per set
- Workpieces don't get damaged due to bearings
- Suitable for heavy workpieces

6888-1

Code	Size (L×W×H)	Code of bearings	Diameter of bearings (ØD)	Range of shafts (Ød)	Load capacity
6888-1	150×60×100mm	16004 ZZ	42mm	25-70mm	500kg
6888-2	150×80×100mm	6303 ZZ	47mm	5-55mm	1000kg
6888-3	230×100×150mm	6306 ZZ	72mm	70-200mm	1000kg

Code	W1	W2	h1	h2	h3	L1	L2	S
6888-1	22	44	20	85	12	100	-	60
6888-2	40	60	22	85	12	100	-	50
6888-3	60	80	30	124	20	180	90	120

(mm)

GRANITE V-BLOCK SETS

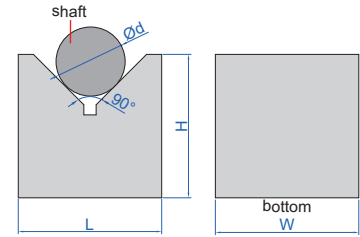
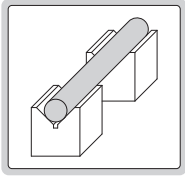

■ Two V-blocks per set

6897-1

Code	Size (L×W×H)	Range of shafts (Ød)	Parallelism of V groove to bottom	Height difference of a matchet pair
6897-1	70×50×70mm	6-70mm	4µm	5µm
6897-2	100×50×70mm	6-84mm	4µm	5µm

MAGNETIC V-BLOCKS (ADVANCED TYPE)

HARDENED SURFACES

HIGH PRECISION

STRONG MAGNETIC FORCE

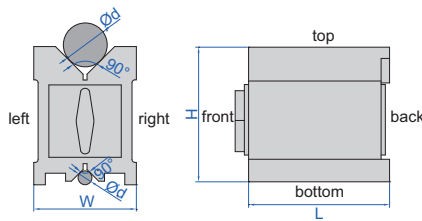

6889-11

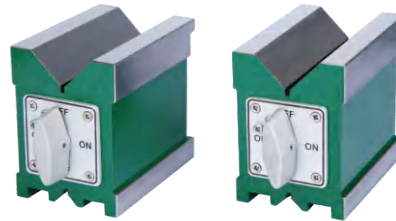

6889-1

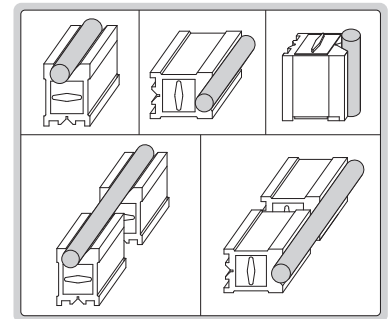

- Hardened, high accuracy, strong magnetic force, for grinding, light milling, drilling and inspection of round and square workpieces
- All working surfaces are hardened to HRC60±2
- Magnetic force on top, bottom and two V grooves
- V groove on the top for large shafts
- V groove on the bottom for small shafts
- Suitable for cast iron surface plates and granite surface plates

Individual

Code	Size (L×W×H)	Range of shafts (Ød)	Magnetic force	Parallelism of V grooves to top, bottom, left, right sides	Squareness of V grooves to back side
6889-11	75×56×75mm	5-40mm	85kgf	5µm	5µm
6889-22	100×70×95mm	5-65mm	150kgf	5µm	5µm
6889-33	150×75×100mm	5-70mm	190kgf	6µm	6µm
6889-55	160×125×130mm	5-140mm	220kgf	12µm	12µm
6889-44	200×125×150mm	10-140mm	400kgf	12µm	12µm

Matched pair

Code	Size (L×W×H)	Range of shafts (Ød)	Magnetic force	Parallelism of V grooves to top, bottom, left, right sides	Squareness of V grooves to back side	Height difference of a matched pair
6889-1	75×56×75mm	5-40mm	85kgf	5µm	5µm	5µm
6889-2	100×70×95mm	5-65mm	150kgf	5µm	5µm	5µm
6889-3	150×75×100mm	5-70mm	190kgf	6µm	6µm	6µm
6889-5	160×125×130mm	5-140mm	220kgf	12µm	12µm	12µm
6889-4	200×125×150mm	10-140mm	400kgf	12µm	12µm	12µm

ATTENTION: NOT SUITABLE FOR STEEL OR IRON SURFACES, OTHERWISE THE MAGNETIC FORCE WILL BE REDUCED

MAGNETIC V-BLOCKS

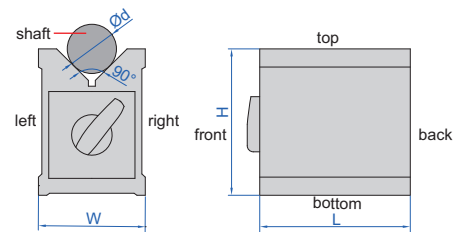
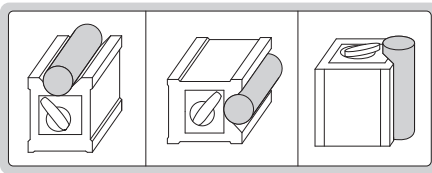

6890-702

- Hold cylindrical workpieces for inspection and machining
- Supplied in single piece
- Not suitable for steel or iron surfaces, otherwise the magnetic force will be reduced

Code	Size (L×W×H)	Range of shafts (Ød)	Magnetic force	Parallelism of V groove to top, bottom, left and right sides	Squareness of V groove to back side	Remark
6890-702	70×60×73mm	6-44mm	56kgf	10µm	10µm	not hardened
6890-702A	70×60×73mm	6-44mm	56kgf	10µm	10µm	hardened surfaces

ATTENTION: NOT SUITABLE FOR STEEL OR IRON SURFACES, OTHERWISE THE MAGNETIC FORCE WILL BE REDUCED

MAGNETIC V-BLOCKS

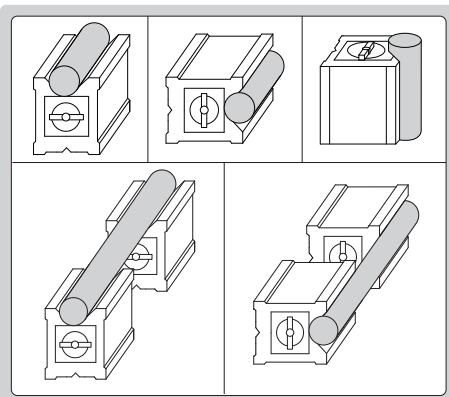

6801-1202



6801-2A

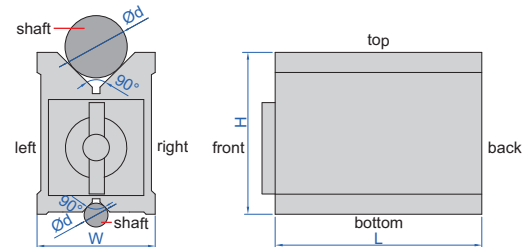

- Hold cylindrical workpieces for inspection and machining
- V groove on the top for large shafts
- V groove on the bottom for small shafts
- Not suitable for steel or iron surfaces, otherwise the magnetic force will be reduced

Individual

Code	Size (L×W×H)	Range of shafts (Ød)	Magnetic force	Parallelism of V grooves to top, bottom, left, right side	Squareness of V grooves to back side	Remark
6801-1201	80×70×95mm	6-67mm	64kgf	10µm	10µm	not hardened
6801-1202	100×70×95mm	6-67mm	80kgf	10µm	10µm	
6801-1203	120×70×95mm	6-67mm	96kgf	10µm	10µm	
6801-1201A	80×70×95mm	6-67mm	64kgf	10µm	10µm	hardened surfaces
6801-1202A	100×70×95mm	6-67mm	80kgf	10µm	10µm	
6801-1203A	120×70×95mm	6-67mm	96kgf	10µm	10µm	

Matched pair

Code	Size (L×W×H)	Range of shafts (Ød)	Magnetic force	Parallelism of V grooves to top, bottom, left, right side	Squareness of V grooves to back side	Height difference of a matched pair	Remark
6801-1	80×70×95mm	6-67mm	64kgf	10µm	10µm	10µm	not hardened
6801-2	100×70×95mm	6-67mm	80kgf	10µm	10µm	10µm	
6801-3	120×70×95mm	6-67mm	96kgf	10µm	10µm	10µm	
6801-1A	80×70×95mm	6-67mm	64kgf	10µm	10µm	10µm	hardened surfaces
6801-2A	100×70×95mm	6-67mm	80kgf	10µm	10µm	10µm	
6801-3A	120×70×95mm	6-67mm	96kgf	10µm	10µm	10µm	

MAGNETIC INDUCTION V-BLOCK SET

ATTENTION: NOT HARDENED, DO NOT ROTATE WORKPIECES ON V-BLOCKS

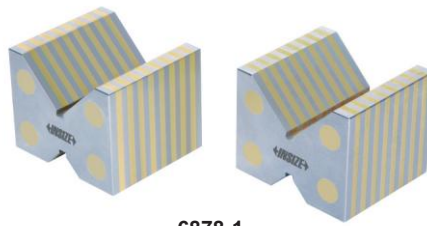

6878-1

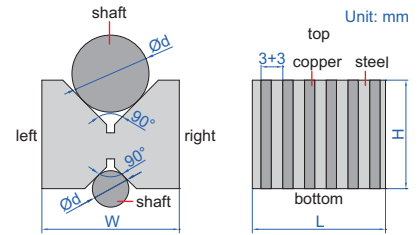

- Hold cylindrical workpieces for inspection and machining
- To be used on magnetic chucks
- Two V-blocks per set
- V groove on the top for large shafts
- V groove on the bottom for small shafts
- Hardness HRB70
- Non-magnetic copper strips

Code	Size (L×W×H)	Range of shafts (∅d)	Pole pitch	Parallelism of both V grooves to top and bottom sides	Height difference of a matched pair
6878-1	52×58×46mm	6-56mm	3+3mm	10μm	10μm

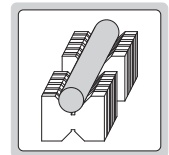

MAGNETIC V-BLOCK SETS

ATTENTION: NOT HARDENED, DO NOT ROTATE WORKPIECES ON V-BLOCKS

ATTENTION: LOW MAGNETIC FORCE



6891-1

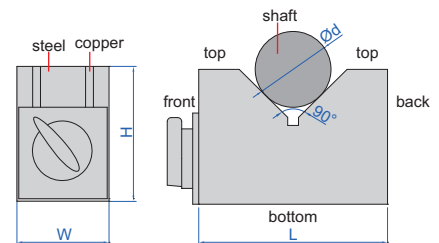

- Hold cylindrical workpieces for inspection, not suitable for machining due to low magnetic force
- Two V-blocks per set
- Hardness HRB70

Code	Size (L×W×H)	Range of shafts (∅d)	Magnetic force	Parallelism of V groove to bottom and back sides	Height difference of a matched pair
6891-1	70×40×50mm	6-46mm	15kgf	10μm	10μm
6891-3	150×50×100mm	6-125mm	21kgf	10μm	10μm

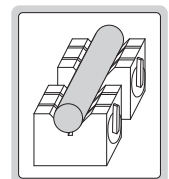

GRANITE SQUARE WITH V GROOVE



4142-200

- Parallelism and squareness of A, B, C, D, E and F: 6 μ m
- Parallelism and squareness of V groove to A, B, C, D, E and F: 6 μ m

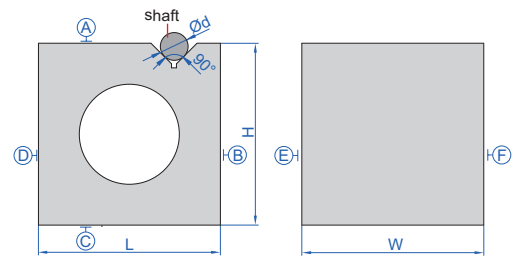

Code	Size (L×W×H)	Range of shaft (Ød)
4142-200	200×200×200mm	9~70mm

ATTENTION: NOT HARDENED, DO NOT ROTATE WORKPIECES ON V-BLOCKS

MAGNETIC SQUARE WITH V GROOVE



6539-100

- Hold flat and cylindrical workpieces for inspection and machining
- Magnetic force on top, left, right and V grooves
- Parallelism and squareness of top, bottom, left, right and back: 20 μ m
- Parallelism and squareness of V grooves to top, bottom, left, right and back: 20 μ m

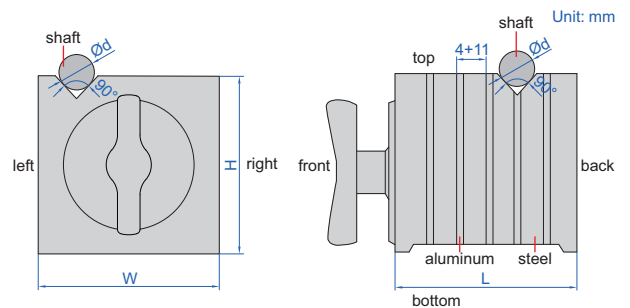

Unit: mm

Code	Size (L×W×H)	Magnetic force of V grooves		Magnetic force of top, left and right sides		Range of shafts (Ød)
		on granite surface plate	on cast iron plate	on granite surface plate	on cast iron plate	
6539-100	100×100×100mm	30kgf	25kgf	50kgf	30kgf	5-30mm

PERMANENT MAGNETIC CHUCKS

ATTENTION:
NOT HARDENED



6537-400

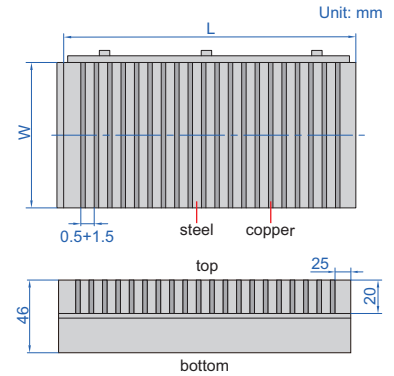

- The magnetic pole arrangement is dense and can hold thin and small workpieces

Code	Table size (L×W)	Magnetic force	Pole pitch	Parallelism of top to bottom
6537-175	175×100mm	8kgf/cm ²	0.5+1.5mm	0.02mm/300mm
6537-250	250×125mm	8kgf/cm ²	0.5+1.5mm	0.02mm/300mm
6537-150	150×150mm	8kgf/cm ²	0.5+1.5mm	0.02mm/300mm
6537-300	300×150mm	8kgf/cm ²	0.5+1.5mm	0.02mm/300mm
6537-350	350×150mm	8kgf/cm ²	0.5+1.5mm	0.02mm/300mm
6537-401	400×150mm	8kgf/cm ²	0.5+1.5mm	0.02mm/300mm
6537-451	450×150mm	8kgf/cm ²	0.5+1.5mm	0.02mm/300mm
6537-400	400×200mm	8kgf/cm ²	0.5+1.5mm	0.02mm/300mm
6537-450	450×200mm	8kgf/cm ²	0.5+1.5mm	0.02mm/300mm
6537-500	500×200mm	8kgf/cm ²	0.5+1.5mm	0.02mm/300mm

ROUND PERMANENT MAGNETIC CHUCKS

ATTENTION:
NOT HARDENED



6542-300

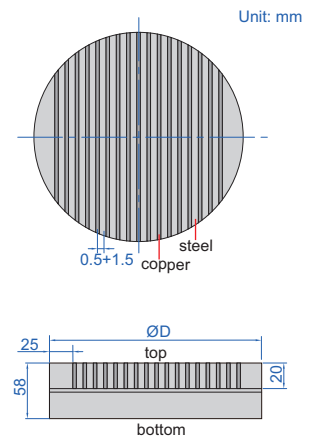

- The magnetic pole arrangement is dense and can hold thin and small workpieces
- Parallelism of top to bottom: 0.02mm/300mm

Code	Table size (ØD)	Magnetic force	Pole pitch
6542-125	125mm	8kgf/cm ²	0.5+1.5mm
6542-160	160mm	8kgf/cm ²	0.5+1.5mm
6542-200	200mm	8kgf/cm ²	0.5+1.5mm
6542-250	250mm	8kgf/cm ²	0.5+1.5mm
6542-300	300mm	8kgf/cm ²	0.5+1.5mm

MAGNETIC PARALLEL SETS

- One side with magnets, can reduce clamping time
- Parallelism between top and bottom: 5µm
- Height difference of a matched pair: 5µm
- Made of alloy tool steel
- Hardened to HRC55-60



6509-125

Code	Parallels per set	Length (L)	Thickness (W)	Height (H)
6509-90	5 pairs	90mm	2.5mm	15, 22, 25, 30, 32mm
6509-125	5 pairs	125mm	2.5mm	15, 30, 35, 37, 39mm
6509-150	5 pairs	150mm	2.5mm	25, 35, 40, 45, 47mm
6509-160	5 pairs	160mm	2.5mm	22, 30, 37, 42, 47mm
6509-200	5 pairs	200mm	2.5mm	25, 40, 47, 52, 57mm



PARALLEL SETS

- Parallelism between top and bottom: 5µm
- Height difference of a matched pair: 5µm
- Made of alloy tool steel
- Hardened to HRC55-60



6533-144

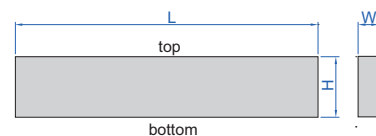

Code	Parallels per set	Length (L)	Thickness (W)	Height (H)
6533-6	6 pairs	200mm	9.5mm	35, 40, 45, 50, 55, 58mm
6533-8	8 pairs	160mm	8mm	12*, 17, 22, 25, 28, 32, 36, 38mm
6533-81	8 pairs	200mm	8mm	17, 22, 26, 28, 32, 36, 38, 42mm
6533-9	9 pairs	160mm	4mm	10*, 14*, 18, 22, 26, 30, 34, 38, 42mm
6533-10	10 pairs	150mm	3mm	13, 16, 19, 22, 25, 28, 31, 35, 38, 41mm
6533-144	14 pairs	150mm	10mm	14, 16, 18, 20, 22, 24, 26, 28, 30, 32, 35, 40, 45, 50mm

* Parallelism between top and bottom and height difference of a matched pair of 12mm in **6533-8**, 10mm, 14mm in **6533-9** is 7µm

PARALLEL SETS

- Parallelism between top and bottom: 5µm
- Height difference of a matched pair: 5µm
- Made of alloy tool steel
- Hardened to HRC55-60

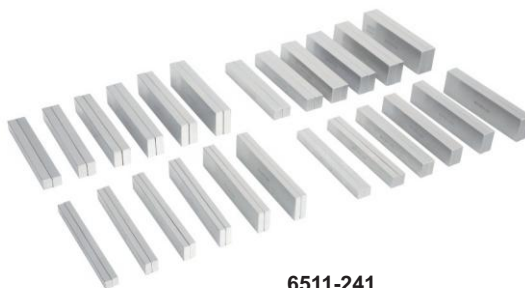

6511-241



Code	Parallels per set	Length (L)	Height (H)×Thickness (W)
6511-20	20 pairs	100mm	5×2*, 10×2, 15×2, 20×2, 6×3*, 11×3, 16×3, 21×3, 7×4*, 12×4, 17×4, 22×4, 8×5*, 13×5, 18×5, 23×5, 9×6*, 14×6, 19×6, 24×6mm
6511-24	24 pairs	125mm	11×8, 16×8, 21×8, 26×8, 31×8, 36×8, 13×10, 18×10, 23×10, 28×10, 33×10, 38×10, 15×12, 20×12, 25×12, 30×12, 35×12, 40×12, 17×14, 22×14, 27×14, 32×14, 37×14, 42×14mm
6511-241	24 pairs	150mm	11×8, 16×8, 21×8, 26×8, 31×8, 36×8, 13×10, 18×10, 23×10, 28×10, 33×10, 38×10, 15×12, 20×12, 25×12, 30×12, 35×12, 40×12, 17×14, 22×14, 27×14, 32×14, 37×14, 42×14mm

* Parallelism between top and bottom and height difference of a matched pair of 5×2mm, 6×3mm, 7×4mm, 8×5mm and 9×6mm in **6511-20** is 7µm

PARALLELS

- Made of alloy tool steel
- Hardened to HRC55-60
- Supplied in pair

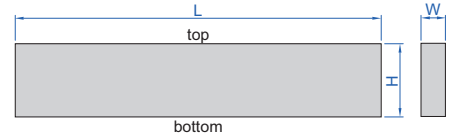

6512-2210A

L=125mm	L=150mm	L=200mm			
Code	Code	Code	H×W	Parallelism between top and bottom	Height difference of a matched pair
6512-118	6512-1181	6512-1182	11×8mm	5μm	5μm
6512-168	6512-1681	6512-1682	16×8mm	5μm	5μm
6512-218	6512-2181	6512-2182	21×8mm	5μm	5μm
6512-268	6512-2681	6512-2682	26×8mm	5μm	5μm
6512-318	6512-3181	6512-3182	31×8mm	5μm	5μm
6512-368	6512-3681	6512-3682	36×8mm	5μm	5μm
6512-1310	6512-13101	6512-13102	13×10mm	5μm	5μm
6512-1810	6512-18101	6512-18102	18×10mm	5μm	5μm
6512-2310	6512-23101	6512-23102	23×10mm	5μm	5μm
6512-2810	6512-28101	6512-28102	28×10mm	5μm	5μm
6512-3310	6512-33101	6512-33102	33×10mm	5μm	5μm
6512-3810	6512-38101	6512-38102	38×10mm	5μm	5μm
6512-1512	6512-15121	6512-15122	15×12mm	5μm	5μm
6512-2012	6512-20121	6512-20122	20×12mm	5μm	5μm
6512-2512	6512-25121	6512-25122	25×12mm	5μm	5μm
6512-3012	6512-30121	6512-30122	30×12mm	5μm	5μm
6512-3512	6512-35121	6512-35122	35×12mm	5μm	5μm
6512-4012	6512-40121	6512-40122	40×12mm	5μm	5μm
6512-1714	6512-17141	6512-17142	17×14mm	5μm	5μm
6512-2214	6512-22141	6512-22142	22×14mm	5μm	5μm
6512-2714	6512-27141	6512-27142	27×14mm	5μm	5μm
6512-3214	6512-32141	6512-32142	32×14mm	5μm	5μm
6512-3714	6512-37141	6512-37142	37×14mm	5μm	5μm
6512-4214	6512-42141	6512-42142	42×14mm	5μm	5μm

L=100mm

Code	H×W	Parallelism between top and bottom	Height difference of a matched pair
6512-52	5×2mm	7μm	7μm
6512-102	10×2mm	5μm	5μm
6512-152	15×2mm	5μm	5μm
6512-202	20×2mm	5μm	5μm
6512-63	6×3mm	7μm	7μm
6512-113	11×3mm	5μm	5μm
6512-163	16×3mm	5μm	5μm
6512-213	21×3mm	5μm	5μm
6512-74	7×4mm	7μm	7μm
6512-124	12×4mm	5μm	5μm
6512-174	17×4mm	5μm	5μm
6512-224	22×4mm	5μm	5μm
6512-85	8×5mm	7μm	7μm
6512-135	13×5mm	5μm	5μm
6512-185	18×5mm	5μm	5μm
6512-235	23×5mm	5μm	5μm
6512-96	9×6mm	7μm	7μm
6512-146	14×6mm	5μm	5μm
6512-196	19×6mm	5μm	5μm
6512-246	24×6mm	5μm	5μm

L=150mm

Code	H×W	Parallelism between top and bottom	Height difference of a matched pair
6512-1410A	14×10mm	5μm	5μm
6512-1610A	16×10mm	5μm	5μm
6512-1810A	18×10mm	5μm	5μm
6512-2010A	20×10mm	5μm	5μm
6512-2210A	22×10mm	5μm	5μm
6512-2410A	24×10mm	5μm	5μm
6512-2610A	26×10mm	5μm	5μm
6512-2810A	28×10mm	5μm	5μm
6512-3010A	30×10mm	5μm	5μm
6512-3210A	32×10mm	5μm	5μm
6512-3510A	35×10mm	5μm	5μm
6512-4010A	40×10mm	5μm	5μm
6512-4510A	45×10mm	5μm	5μm
6512-5010A	50×10mm	5μm	5μm

To be continued

Continued from previous page

L=160mm

Code	H×W	Parallelism between top and bottom	Height difference of a matched pair
6512-104A	10×4mm	5µm	5µm
6512-144A	14×4mm	5µm	5µm
6512-184A	18×4mm	5µm	5µm
6512-224A	22×4mm	5µm	5µm
6512-264A	26×4mm	5µm	5µm
6512-304A	30×4mm	5µm	5µm
6512-344A	34×4mm	5µm	5µm
6512-384A	38×4mm	5µm	5µm
6512-424A	42×4mm	5µm	5µm
6512-128A	12×8mm	5µm	5µm
6512-178A	17×8mm	5µm	5µm
6512-228A	22×8mm	5µm	5µm
6512-258A	25×8mm	5µm	5µm
6512-288A	28×8mm	5µm	5µm
6512-328A	32×8mm	5µm	5µm
6512-368A	36×8mm	5µm	5µm
6512-388A	38×8mm	5µm	5µm

L=200mm

Code	H×W	Parallelism between top and bottom	Height difference of a matched pair
6512-178B	17×8mm	5µm	5µm
6512-228B	22×8mm	5µm	5µm
6512-268B	26×8mm	5µm	5µm
6512-288B	28×8mm	5µm	5µm
6512-328B	32×8mm	5µm	5µm
6512-368B	36×8mm	5µm	5µm
6512-388B	38×8mm	5µm	5µm
6512-428B	42×8mm	5µm	5µm

PARALLEL SET

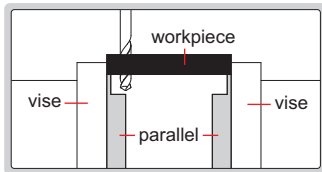

6534-6

- Parallelism between top and bottom: 5µm
- Height difference of a matched pair: 5µm
- Made of alloy tool steel
- Hardened to HRC55-60

Code	Parallels per set	Height (H)
6534-6	6 pairs	25, 30, 35, 40, 45, 48mm

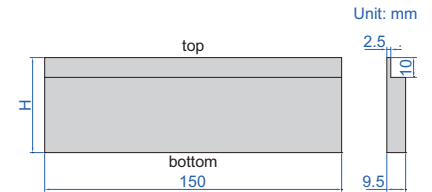

GRANITE PARALLEL SET



4143-250

- Made of granite, hard and no rusty, no dimensional change over time or temperature change
- Two parallels per set

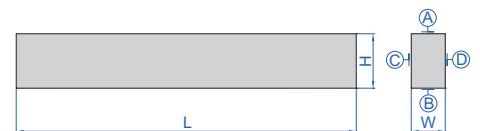
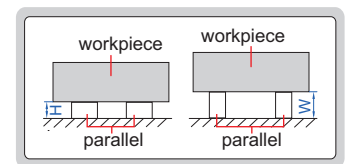

Code	Size (L×W×H)	Parallelism between A and B	Parallelism between C and D	Height difference of a matched pair
4143-250	250×25×40mm	3µm	3µm	3µm

PARALLEL/SQUARE SET

screws and wrench are included



6531-25

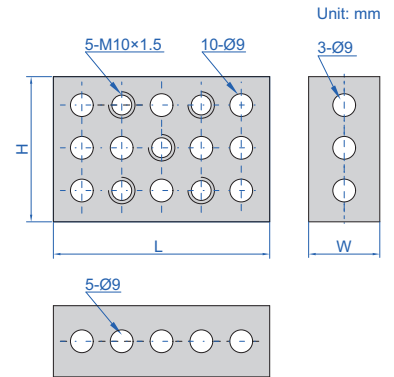

- Pairs of matched blocks for positioning and set-up
- Screws and wrench are included
- Hardness HRC60±2

Code	Size (L×H×W)	Size accuracy	Squareness	Parallelism	Height difference of a matched pair
6531-25	75×50×25mm	5µm	5µm/25mm	5µm	5µm

MAGNETIC INDUCTION PARALLEL SET

ATTENTION: NOT HARDENED

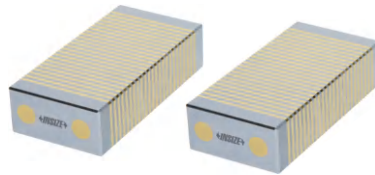

6879-1

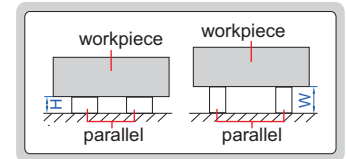

- To be used on magnetic chucks
- Two parallels per set
- Hardness HRB70
- Non-magnetic copper strips

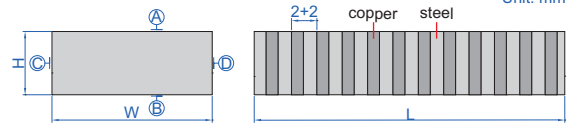

Code	Size (L×W×H)	Pole pitch	Parallelism between A and B	Parallelism between C and D	Height difference of a matched pair
6879-1	100×50×25mm	2+2mm	10µm	10µm	10µm

ANGLE PLATE SETS

- For angle set-up in tooling, production and inspection
- Hardness HRC52

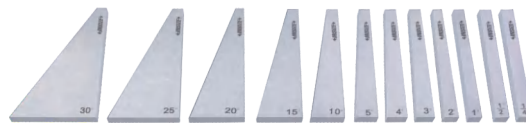

4006-12

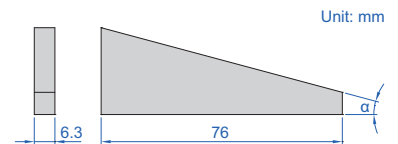

Code	Angle plates included	Angle α	Accuracy
4006-10	10 pcs	1°, 2°, 3°, 4°, 5°, 10°, 15°, 20°, 25°, 30°	±20 seconds
4006-12	12 pcs	1/4°, 1/2°, 1°, 2°, 3°, 4°, 5°, 10°, 15°, 20°, 25°, 30°	±20 seconds

ANGLE PLATE SET

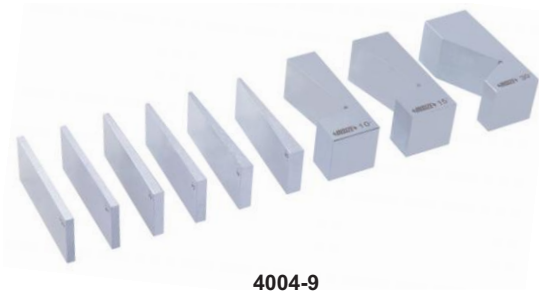

4004-9

- For angle set-up in tooling, production and inspection
- Made of tool steel
- Hardness HRC55

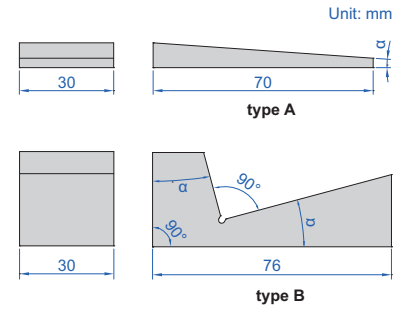

Code	Angle plates included	Angle α	Type	Accuracy
4004-9	9 pcs	1/2°, 1°, 2°, 3°, 4°, 5°	type A	±30 seconds
		10°, 15°, 30°	type B	±50 seconds

ADJUSTABLE ANGLE BLOCKS



6535-30

- Made of hardened tool steel
- With locking screw
- Accuracy of angle: 15 minutes

Code	Size (L×W×H)	h	Adjustable angle	Graduation of angle
6535-25	75×25×32mm	25mm	15°~0°~60°	10 minutes
6535-30	102×30×49mm	30mm	15°~0°~60°	10 minutes

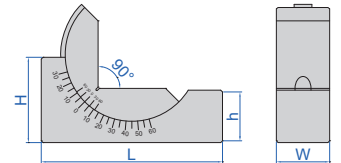

RIGHT ANGLE PLATE

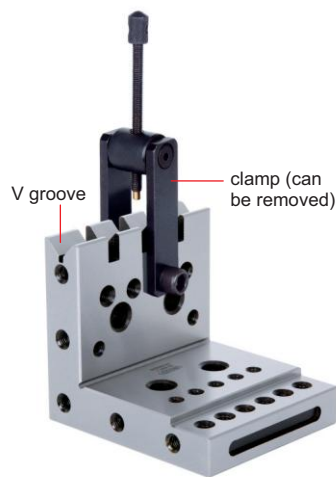

6547-1

- Made of alloy steel
- Hardened to HRC60±2
- V groove for cylinders
- Parallelism and squareness between A, B, C, D, E, F, G and H: 10µm
- Parallelism and squareness of V groove to A, B, C, D, E, F, G and H: 10µm

Code	Size (L×W×H)
6547-1	100×100×115mm

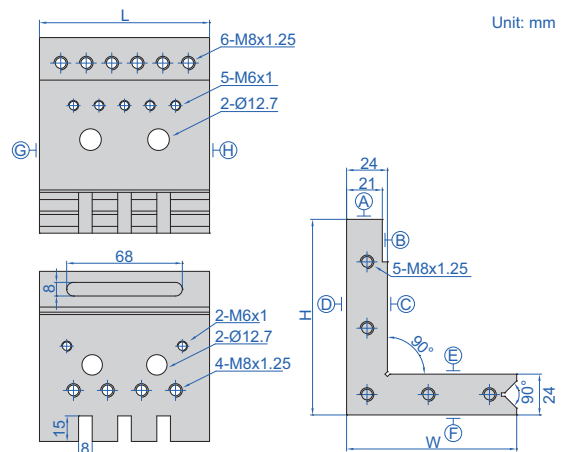

RIGHT ANGLE PLATE

- Made of tool steel
- Hardened to HRC60±2
- Squareness or parallelism between A, B, C and D: 5µm

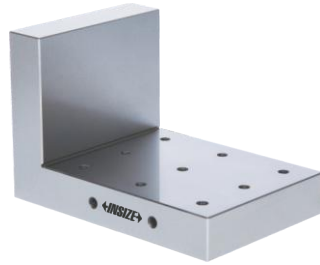

6548-1

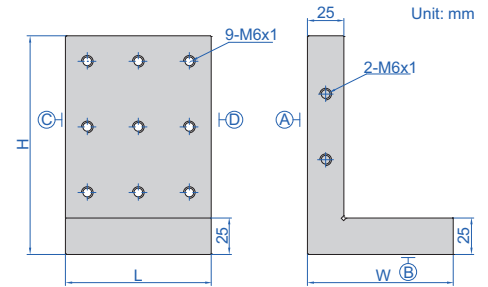

Code	Size (L×W×H)
6548-1	100×100×150mm

RIGHT ANGLE PLATE

- Made of tool steel
- Hardened to HRC56-58
- Parallelism between A, B, C, D, E and F: 3µm
- Squareness between A, B, C, D, E and F: 5µm



6549-1

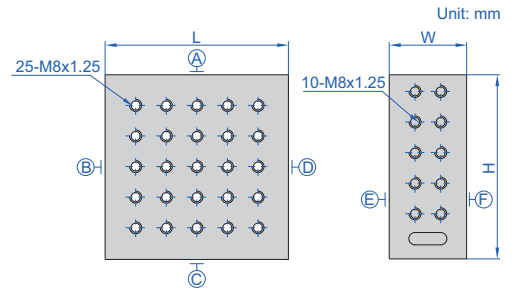

Code	Size (L×W×H)
6549-1	150×63×150mm

SINE BARS

CAN BE CUSTOMIZED



4155-100

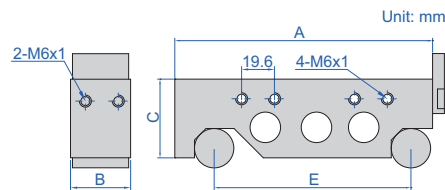
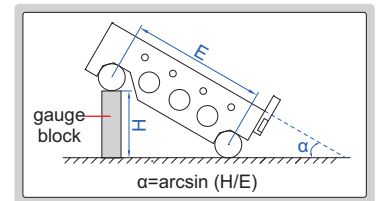

- Made of alloy tool steel

the front and back ends and two sides have mounting holes to install plate

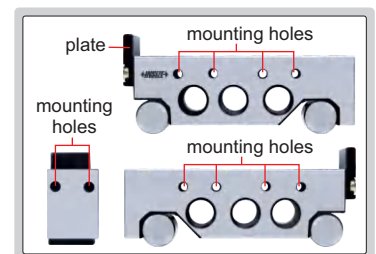

Code	Roller distance (E)	Table size (A×B)	C	Accuracy of α at 30°
4155-100	100mm	130×30mm	40mm	±5 seconds
4155-200	200mm	230×30mm	40mm	±5 seconds
4155-300	300mm	345×40mm	50mm	±8 seconds

SINE BAR

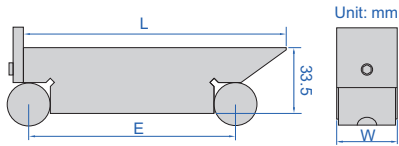

Unit: mm



4158-100

- Made of alloy tool steel

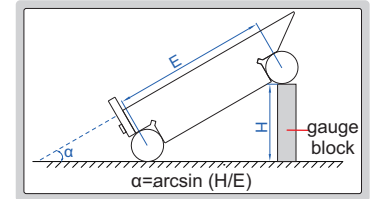

Code	Roller distance (E)	Table size (L×W)	Accuracy of α at 30°
4158-100	100mm	130×30mm	±5 seconds

SINE TABLE



6527-100

- Accuracy of angle: ±15 seconds
- Made of alloy tool steel
- Hardness HRC58-60

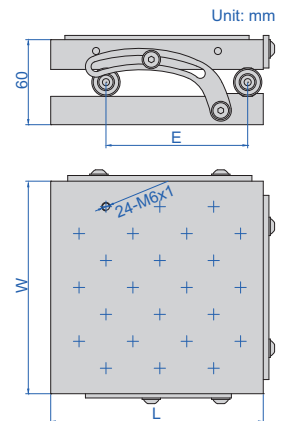

Code	Roller distance (E)	Table size (L×W)	Adjustable angle
6527-100	100mm	150×150mm	0-60°

COMPOUND SINE TABLE



6536-100

- Accuracy of angle: ±15 seconds
- Made of alloy tool steel
- Hardness HRC58-60

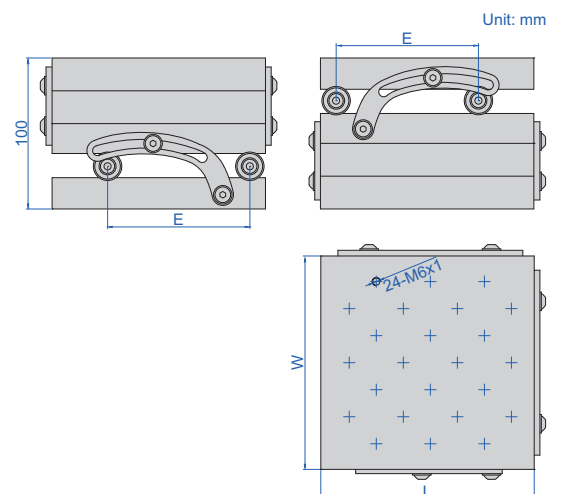

Code	Roller distance (E)	Table size (L×W)	Adjustable angle
6536-100	100mm	150×150mm	0-60°

MAGNETIC SINE TABLE

ATTENTION:
NOT HARDENED



6538-100

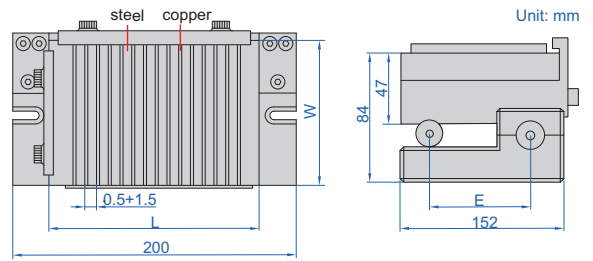

Code	Table size (L×W)	Roller distance (E)	Adjustable angle	Accuracy of angle
6538-100	150×150mm	100mm	0-60°	±15 seconds

PRECISION SINE VISES

- Parallelism: 5µm/100mm
- Squareness: 5µm/100mm
- Adjustable angle: 0-55°
- Accuracy of angle: ±20 seconds
- Made of alloy steel
- Hardness HRC58-60

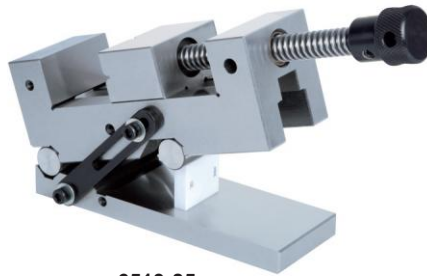

6513-85

Code	Jaw opening (Q)	Jaw width (W)	Roller distance (E)	(mm)		
				L	H	M
6513-65	0-65	50	100	150	85	25
6513-85	0-85	63	100	185	91.5	32
6513-100	0-100	73	150	205	105	35
6513-1001	0-100	80	150	215	108	40
6513-125	0-125	88	150	245	108	40
6513-1251	0-125	100	200	255	116	45
6513-160	0-160	125	200	295	125	50
6513-175	0-175	150	200	315	125	50

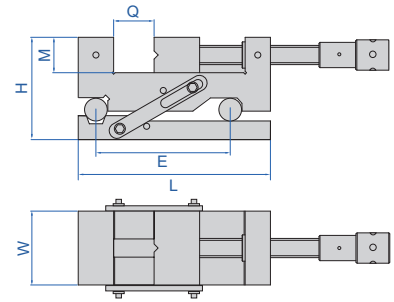

PRECISION SINE VISE

there is a 1mm step (accuracy +/-0.002mm), gauge blocks smaller than 0.5mm are not available. if small gauge blocks are needed (for example, 0.25mm), a gauge block 1.25mm can be used in order to make 1.25mm-1mm=0.25mm

16

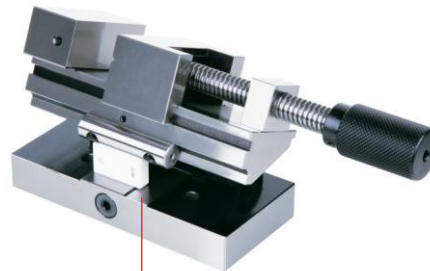

6523-80

- Parallelism: 3µm/100mm
- Squareness: 5µm/100mm
- Accuracy of angle: ±15 seconds
- Made of SKS tool steel, subzero treatment
- Hardness HRC58-60

Code	Jaw opening (Q)	Jaw width (W)	Adjustable angle
6523-80	0-80mm	73mm	0-46°

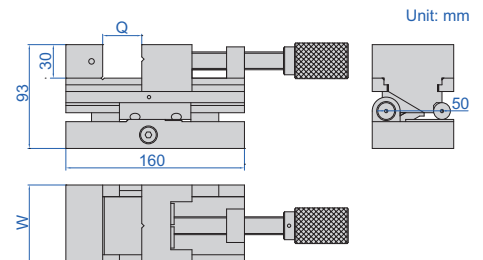

PRECISION COMPOUND SINE VISE

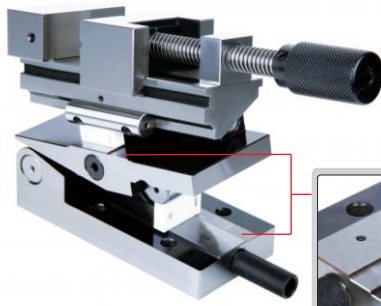

6524-80

there is a 1mm step (accuracy $\pm 0.002\text{mm}$). gauge blocks smaller than 0.5mm are not available. if small gauge blocks are needed (for example, 0.25mm), a gauge block 1.25mm can be used in order to make $1.25\text{mm} - 1\text{mm} = 0.25\text{mm}$

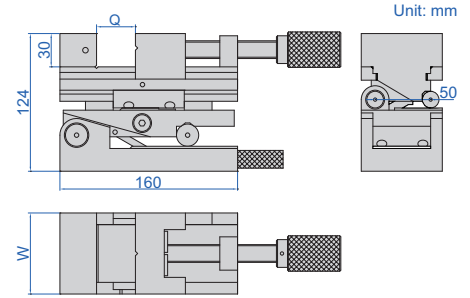
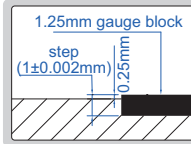

- Parallelism: $3\mu\text{m}/100\text{mm}$
- Squareness: $5\mu\text{m}/100\text{mm}$
- Accuracy of angle: ± 15 seconds
- Made of SKS tool steel, subzero treatment
- Hardness HRC58-60

Code	Jaw opening (Q)	Jaw width (W)	Adjustable angle
6524-80	0-80mm	73mm	0-46°

PRECISION VISES

- Parallelism: $5\mu\text{m}/100\text{mm}$
- Squareness: $5\mu\text{m}/100\text{mm}$
- Made of alloy steel
- Hardness HRC58-60

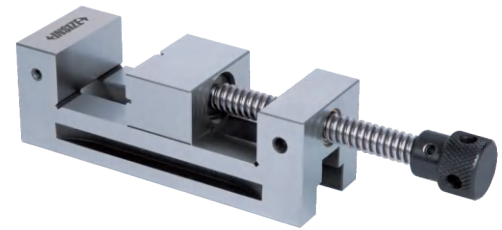

6520-87

(mm)

Code	Jaw opening (Q)	Jaw width (W)	L	H	M
6520-36	0-36	38	115	48	25
6520-67	0-67	50	150	50	25
6520-87	0-87	63	185	63	32
6520-102	0-102	73	205	70	35
6520-1021	0-102	80	215	80	40
6520-127	0-127	88	245	80	40
6520-1271	0-127	100	255	90	45
6520-162	0-162	125	295	100	50
6520-175	0-175	150	315	100	50
6520-200	0-200	200	350	110	55

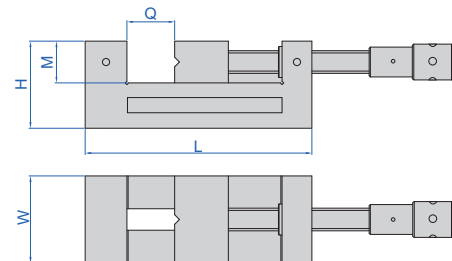

PRECISION VISES (HIGH PRECISION)

- Parallelism: $3\mu\text{m}/100\text{mm}$
- Squareness: $4\mu\text{m}/100\text{mm}$
- Made of alloy steel
- Hardness HRC58-62



6525-87

(mm)

Code	Jaw opening (Q)	Jaw width (W)	L	H	M
6525-36	0-36	38	115	48	25
6525-67	0-67	50	150	50	25
6525-87	0-87	63	185	63	32
6525-102	0-102	73	205	70	35
6525-1021	0-102	80	215	80	40
6525-127	0-127	88	245	80	40
6525-1271	0-127	100	255	90	45
6525-162	0-162	125	295	100	50
6525-175	0-175	150	315	100	50

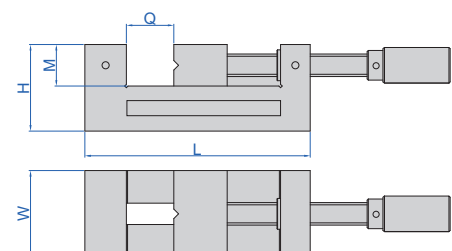

MINI QUICK MOVING PRECISION VISE (WITH STEPS)

- Parallelism: 3µm
- Squareness: 3µm
- Made of alloy steel
- Hardness HRC58-62

(mm)

Code	Jaw opening (Q)	Jaw width (W)
6516-20	0-20	25



6516-20

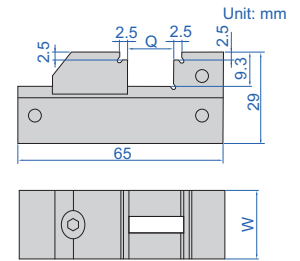

QUICK MOVING PRECISION VISES

- Parallelism: 5µm/100mm
- Squareness: 5µm/100mm
- Made of alloy steel
- Hardness HRC58-60

(mm)

Code	Jaw opening (Q)	Jaw width (W)	L	H	M
6526-20	0-20	25	65	29	9.3
6526-40	0-40	38	100	48	23
6526-65	0-65	50	135	50	25
6526-85	0-85	63	170	63	32
6526-100	0-100	73	185	70	35
6526-1001	0-100	80	195	80	40
6526-125	0-125	88	230	80	40
6526-1251	0-125	100	240	90	45
6526-160	0-160	125	280	100	50
6526-175	0-175	150	300	100	50
6526-208	0-208	200	350	110	55



6526-85

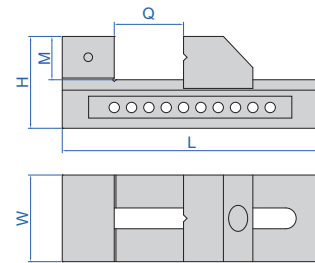

PRECISION UNIVERSAL VISE

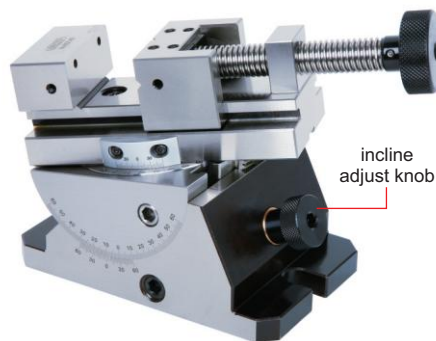

6521-80

- Horizontal rotary: range 360°, graduation 0.05°
- Vertical incline: range 45°, graduation 0.05°
- With incline adjust knob
- Parallelism and squareness between A, B, C and D: 5µm/100mm, parallelism between D and E at 0°: 10µm/100mm
- Made of tool steel
- Hardness HRC56-58

Code	Jaw opening (Q)	Jaw width (W)
6521-80	0-80mm	70mm

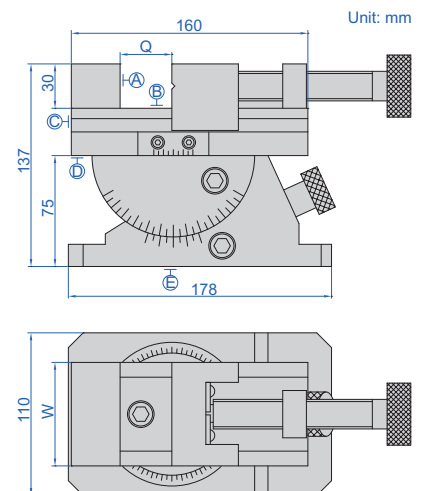

PRECISION UNIVERSAL VISE WITH CHUCK

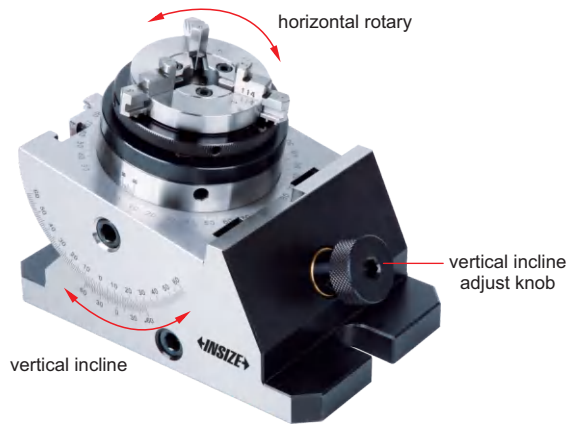

6528-85

- Horizontal rotary: range 360°, graduation 0.05°
- Vertical incline: range 45°, graduation 0.05°
- With vertical incline adjust knob
- Runout of chuck is less than 0.05mm (test position is at less than 50mm from clamping jaws)
- The clamping jaws of chuck are reversible
- Made of tool steel
- Hardness HRC56-58

Code	Range of external clamping	Range of internal clamping
6528-85	Ø0.8~Ø63mm	Ø23~Ø58mm

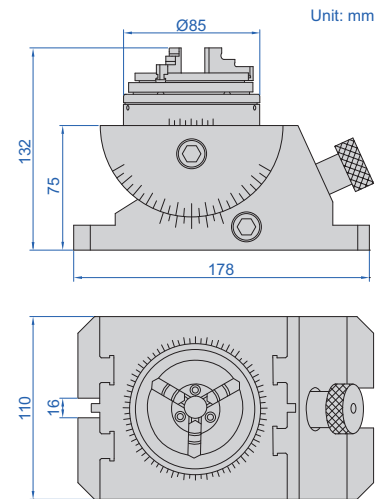

ANVIL VISES

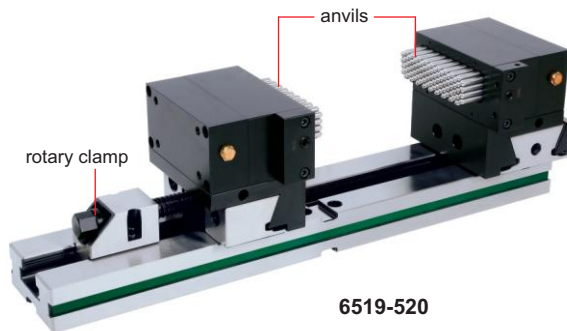

6519-520

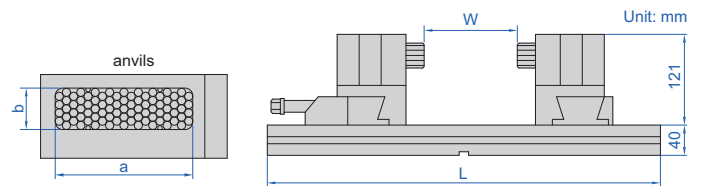

- The vise is used to fix workpieces during machining. The anvils are formed according to the shape of workpieces to be fixed, so the vise can fix workpieces quickly.
- The anvils are made of stainless steel (HRC20), can be customized to carbon steel (HRC40-45)
- Diameter of anvil: 6mm, stroke of anvil: 24mm
- Movement range of rotary clamp: 0-50mm

Code	Guide length (L)	Clamp range (W)	Clamp force*	Weight	a	b
6519-520	520mm	0-190mm	6500N	22.5kg	100mm	30mm
6519-680	680mm	0-320mm	8000N	39.5kg	120mm	36mm

* When all anvils contact the workpieces

application



X-AXIS STAGES



6582-401

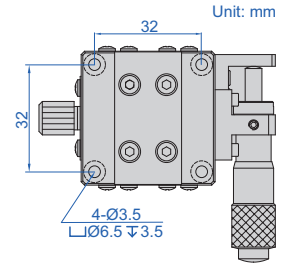
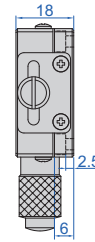
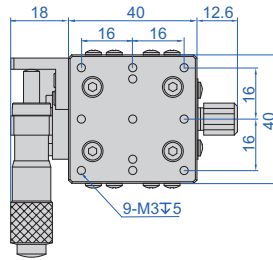

6582-602

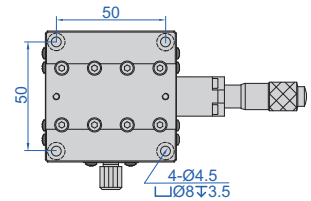
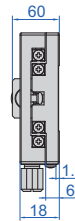
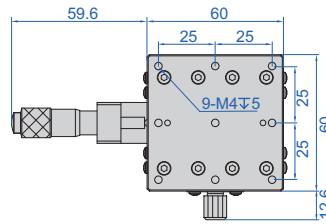

6582-903

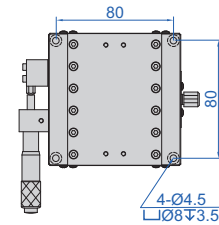
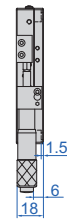
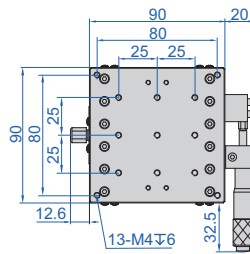

- Cross roller guides, achieve high precision and smooth movement
- Stages made of aluminum alloy

SPECIFICATION (micrometer on the left)

Code	X-axis displacement	Parallelism of top to bottom surface	Micrometer graduation	Micrometer accuracy	Maximum load	Micrometer location	Stage size	Weight
6582-401	±6.5mm	0.02mm	0.01mm	0.01mm	29.4N (3kgf)	left	40x40mm	0.14kg
6582-601	±6.5mm	0.03mm	0.01mm	0.01mm	49N (5kgf)	left	60x60mm	0.24kg
6582-901	±12.5mm	0.03mm	0.01mm	0.02mm	93.1N (9.5kgf)	left	90x90mm	0.47kg
6582-1251	±12.5mm	0.04mm	0.01mm	0.02mm	180N (18.4kgf)	left	125x125mm	1.40kg

SPECIFICATION (micrometer in the middle)

Code	X-axis displacement	Parallelism of top to bottom surface	Micrometer graduation	Micrometer accuracy	Maximum load	Micrometer location	Stage size	Weight
6582-402	±6.5mm	0.02mm	0.01mm	0.01mm	29.4N (3kgf)	middle	40x40mm	0.14kg
6582-602	±6.5mm	0.03mm	0.01mm	0.01mm	49N (5kgf)	middle	60x60mm	0.24kg
6582-902	±12.5mm	0.03mm	0.01mm	0.02mm	93.1N (9.5kgf)	middle	90x90mm	0.47kg
6582-1252	±12.5mm	0.04mm	0.01mm	0.02mm	180N (18.4kgf)	middle	125x125mm	1.40kg

SPECIFICATION (micrometer on the right)

Code	X-axis displacement	Parallelism of top to bottom surface	Micrometer graduation	Micrometer accuracy	Maximum load	Micrometer location	Stage size	Weight
6582-403	±6.5mm	0.02mm	0.01mm	0.01mm	29.4N (3kgf)	right	40x40mm	0.14kg
6582-603	±6.5mm	0.03mm	0.01mm	0.01mm	49N (5kgf)	right	60x60mm	0.24kg
6582-903	±12.5mm	0.03mm	0.01mm	0.02mm	93.1N (9.5kgf)	right	90x90mm	0.47kg
6582-1253	±12.5mm	0.04mm	0.01mm	0.02mm	180N (18.4kgf)	right	125x125mm	1.40kg

XY-AXIS STAGES

Unit: mm



6584-401

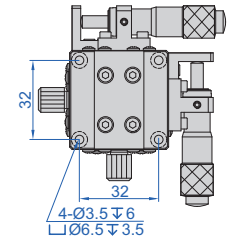
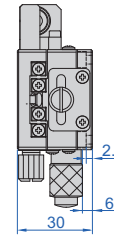
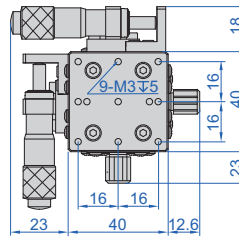

6584-602

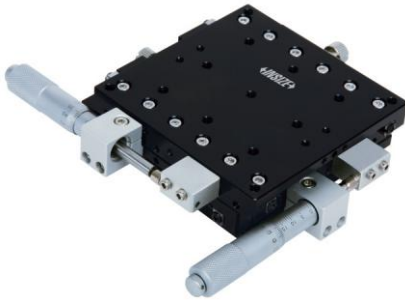
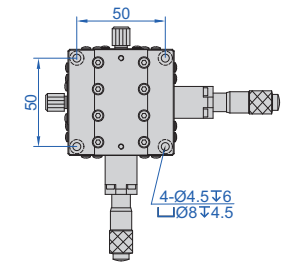
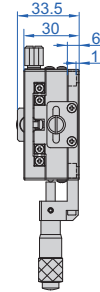
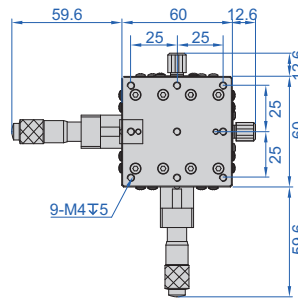

6584-903

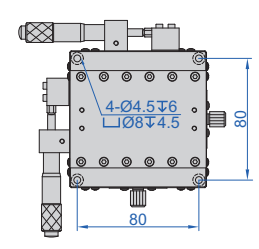
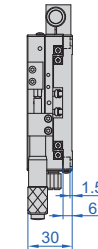
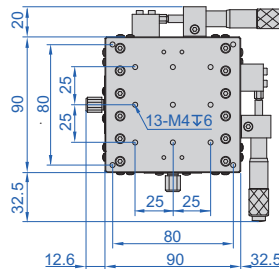

- Cross roller guides, achieve high precision and smooth movement
- Stages made of aluminum alloy

SPECIFICATION (micrometer on the left)

Code	XY-axis displacement	Parallelism of top to bottom surface	Micrometer graduation	Micrometer accuracy	Maximum load	Micrometer location	Stage size	Weight
6584-401	±6.5mm	0.04mm	0.01mm	0.01mm	29.4N (3kgf)	left	40x40mm	0.27kg
6584-601	±6.5mm	0.06mm	0.01mm	0.01mm	49N (5kgf)	left	60x60mm	0.48kg
6584-901	±12.5mm	0.06mm	0.01mm	0.02mm	93.1N (9.5kgf)	left	90x90mm	1kg
6584-1251	±12.5mm	0.08mm	0.01mm	0.02mm	180N (18.4kgf)	left	125x125mm	2.8kg

SPECIFICATION (micrometer in the middle)

Code	XY-axis displacement	Parallelism of top to bottom surface	Micrometer graduation	Micrometer accuracy	Maximum load	Micrometer location	Stage size	Weight
6584-402	±6.5mm	0.04mm	0.01mm	0.01mm	29.4N (3kgf)	middle	40x40mm	0.27kg
6584-602	±6.5mm	0.06mm	0.01mm	0.01mm	49N (5kgf)	middle	60x60mm	0.48kg
6584-902	±12.5mm	0.06mm	0.01mm	0.02mm	93.1N (9.5kgf)	middle	90x90mm	1kg
6584-1252	±12.5mm	0.08mm	0.01mm	0.02mm	180N (18.4kgf)	middle	125x125mm	2.8kg

SPECIFICATION (micrometer on the right)

Code	XY-axis displacement	Parallelism of top to bottom surface	Micrometer graduation	Micrometer accuracy	Maximum load	Micrometer location	Stage size	Weight
6584-403	±6.5mm	0.04mm	0.01mm	0.01mm	29.4N (3kgf)	right	40x40mm	0.27kg
6584-603	±6.5mm	0.06mm	0.01mm	0.01mm	49N (5kgf)	right	60x60mm	0.48kg
6584-903	±12.5mm	0.06mm	0.01mm	0.02mm	93.1N (9.5kgf)	right	90x90mm	1kg
6584-1253	±12.5mm	0.08mm	0.01mm	0.02mm	180N (18.4kgf)	right	125x125mm	2.8kg

Z-AXIS STAGE CODE 6586-60

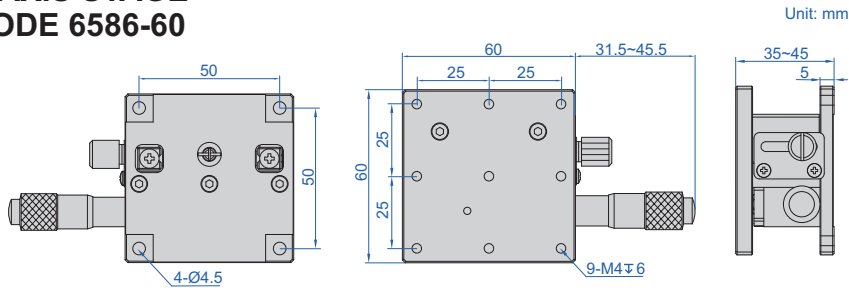

- Cross roller guides, achieve high precision and smooth movement
- Stage made of aluminum alloy

SPECIFICATION

Code	Z-axis displacement	Parallelism of top to bottom surface	Micrometer graduation	Micrometer accuracy	Maximum load	Stage size	Weight
6586-60	10mm	0.05mm	0.01mm	0.02mm	20.4N (3kgf)	60x60mm	0.27kg

XZ-AXIS STAGE CODE 6587-60

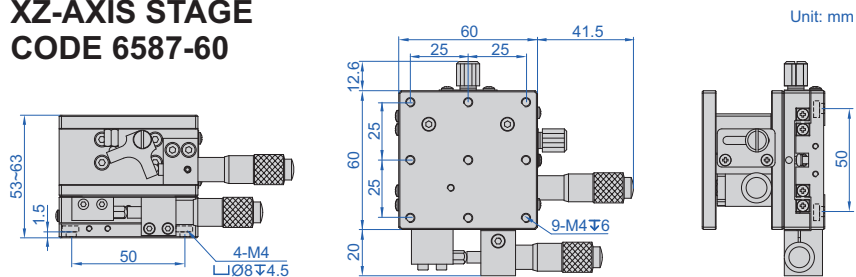

- Cross roller guides, achieve high precision and smooth movement
- Stage made of aluminum alloy

SPECIFICATION

Code	X-axis displacement	Z-axis displacement	Micrometer graduation	Maximum load	Stage size	Weight
6587-60	±6.5mm	10mm	0.01mm	29.4N (3kgf)	60x60mm	0.51kg

XYZ-AXIS STAGE CODE 6585-60

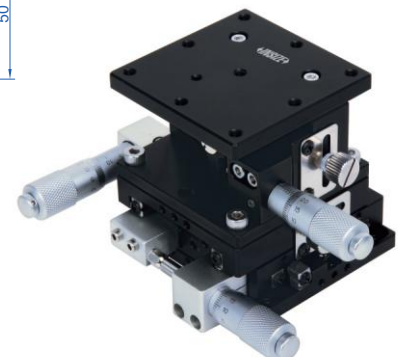
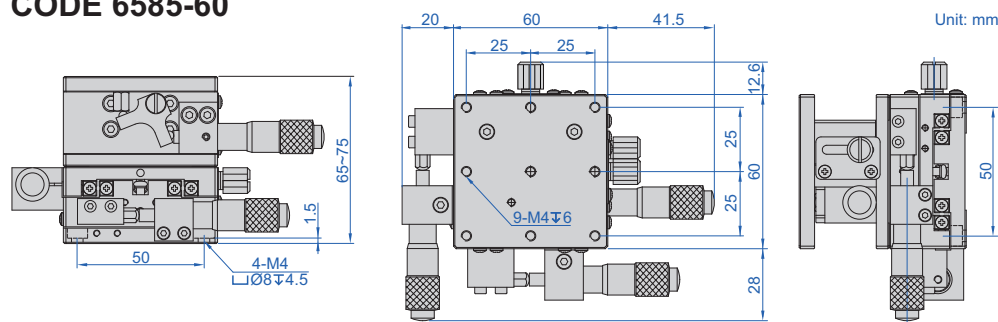

- Cross roller guides, achieve high precision and smooth movement
- Stage made of aluminum alloy

SPECIFICATION

Code	XY-axis displacement	Z-axis displacement	Micrometer graduation	Maximum load	Stage size	Weight
6585-60	±6.5mm	10mm	0.01mm	29.4N (3kgf)	60x60mm	0.75kg

XY-AXIS ROTARY STAGE CODE 6588-60

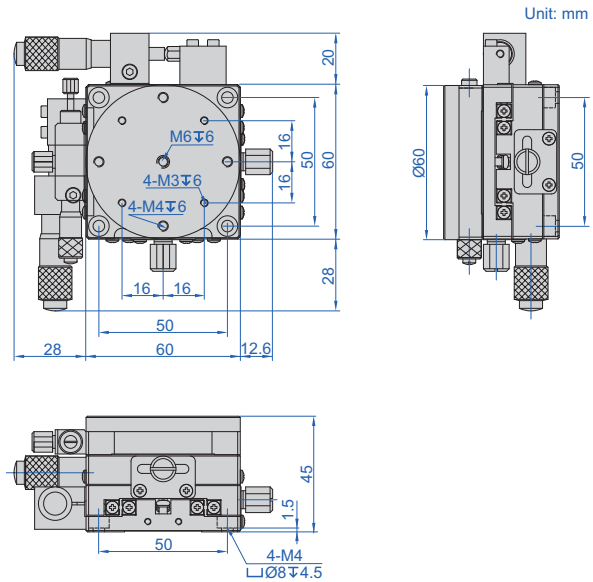

- Cross roller guides, achieve high precision and smooth movement
- Coarse and fine adjustments
- Precise angle adjustment
- Stage made of aluminum alloy

SPECIFICATION

Code	XY-axis displacement	Rotation range	Micrometer graduation	Rotation accuracy	Maximum load	Stage size	Weight
6588-60	±6.5mm	360° coarse, ±5° fine	0.01mm	10 seconds	29.4N (3kgf)	60x60mm	0.64kg

ROTARY STAGES



6583-60H

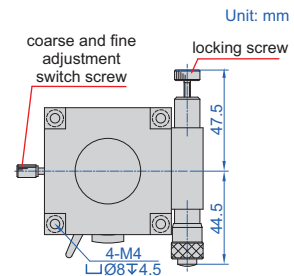
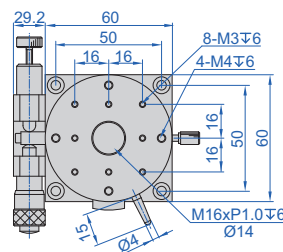

6583-90

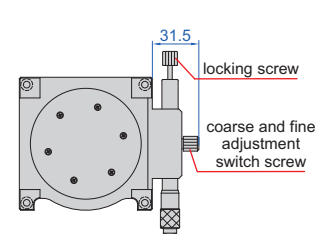
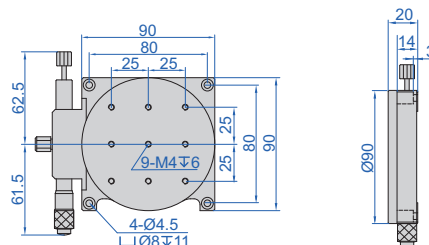

- Precise angle adjustment
- Coarse and fine adjustments
- Stages made of aluminum alloy

SPECIFICATION

Code	Range	Parallelism of top to bottom surface	Concentricity	Rotation accuracy	Maximum load	Stage size	Weight
6583-60H	360° coarse, ±5° fine	0.03mm	0.03mm	12 seconds	29.4N (3kgf)	Ø60mm	0.30kg
6583-90	360° coarse, ±5° fine	0.04mm	0.03mm	5 seconds	29.4N (3kgf)	Ø90mm	0.50kg



Video Measuring Instrument For
Machine Tools
Page 516-517



Centering Indicators
Page 518



Edge Finders
Page 519-521



Edge Finders For EDM
Page 522



Trigger-Type 3D Probes
Page 523



Transmission Probes For
CNC Machine Tools
Page 524-529



Zero Setters With Cable
Page 530-533



Zero Setters
Page 534-535



Vertical Milling Machine
Perpendicularity Measuring Gauges
Page 536



VIDEO MEASURING INSTRUMENT FOR MACHINE TOOLS

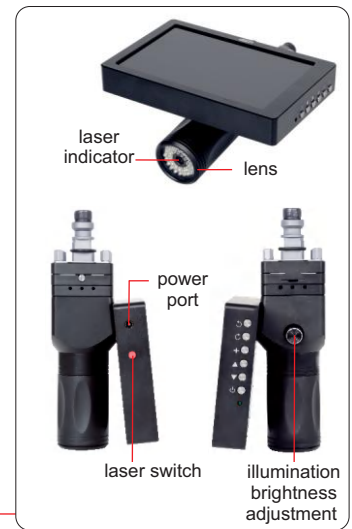

5314-R31

application

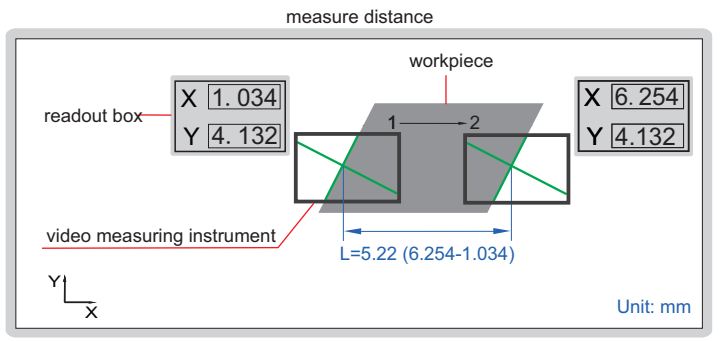
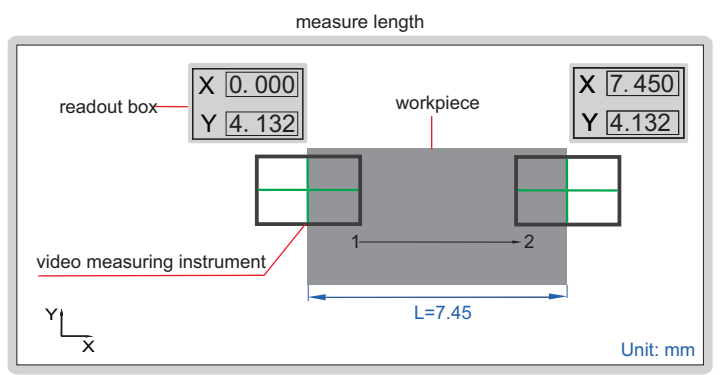
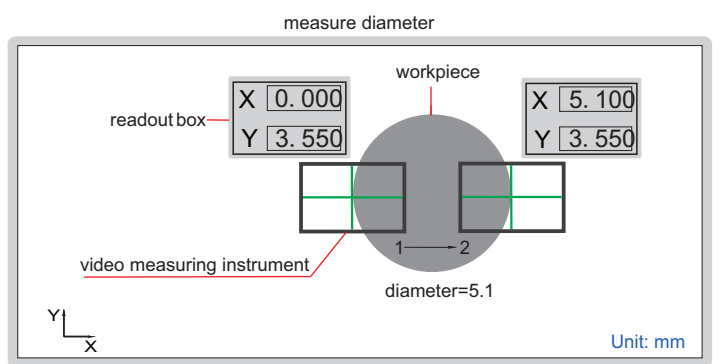

- Used in machine tools such as EDM and CNC
- Working together with linear scale and readout box of machine tools to make 2D measurement, especially suitable for small or thin parts
- Can rotate crosshair and change its color
- With laser indicator to locate position

To be continued

Continued from previous page

SPECIFICATION

Code	5314-R31	5314-R32	5314-R33	5314-R34
Adapter	EROWA	3R	multifunction	magnet
Screen size/pixel	7"/1080P			
Visual accuracy	±0.003mm			
Magnification	50X			
Angle resolution	15'			
Automatic edge-find	after finding the edge, the crosshair changes to green color and prompts			
Color of crosshair	red, blue			
Rotation of crosshair	manual			
Focus distance	50mm			
Light source	LED (adjustable brightness)			
Lithium battery	4800mA (for 4 hours working)			
Power supply	power adapter			
Dimension (L×W×H)	178×90×215mm			
Weight	2kg			

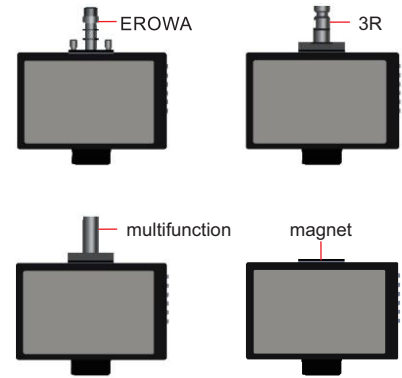

STANDARD DELIVERY

Main unit	1 pc
Power adapter	1 pc

select crosshair color

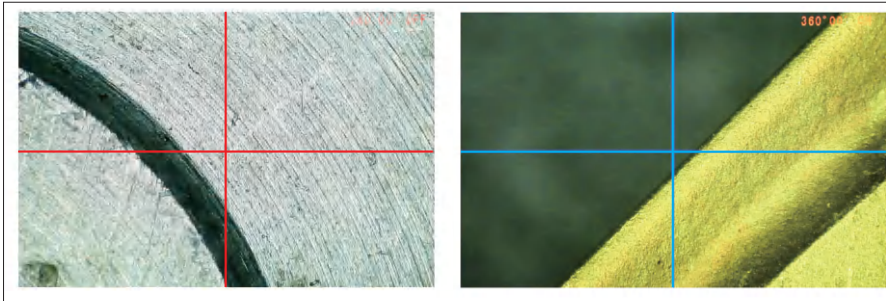

rotate crosshair

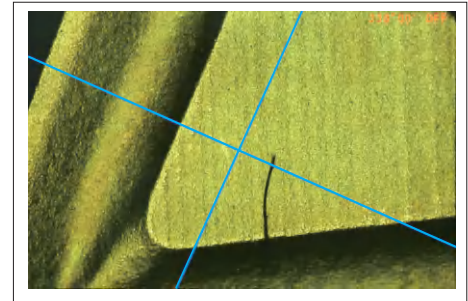

laser indicator locates the central point



after finding the edge, the crosshair changes to green color and prompts

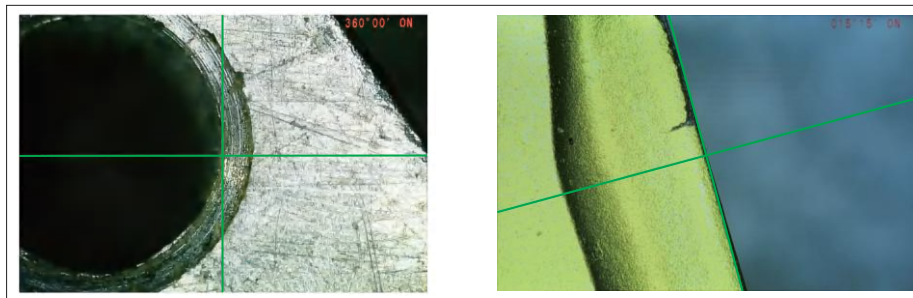

POPULAR MODEL



CENTERING INDICATOR



2385-3

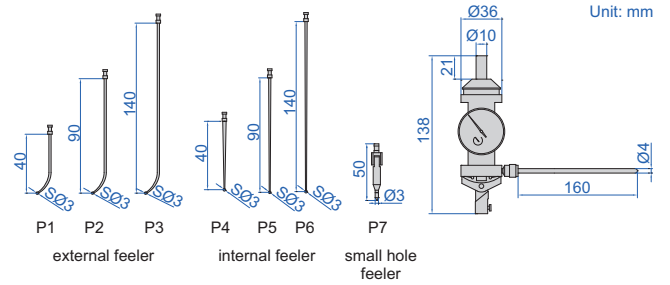

- Provides quick and accurate centering in boring and milling set-up
- Maximum speed is recommended not to exceed 800rpm

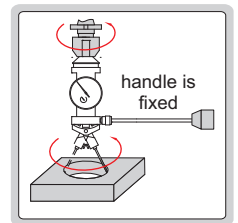

Feeler	Measuring diameter	Accuracy
P1	Ø0-60mm	0.015mm
P2	Ø0-160mm	0.02mm
P3	Ø0-250mm	0.03mm
P4	Ø3.2-80mm	0.015mm
P5	Ø3.2-180mm	0.02mm
P6	Ø3.2-280mm	0.03mm
P7	Ø0-2.8mm	0.015mm

Code
2385-3

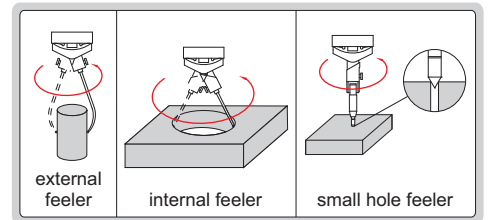

REFER TO PAGE
280-281 FOR DETAILS

DIAL INDICATOR HOLDERS



6296-1



6291-1



6297-1



6294-1A



6295-1A

3D ELECTRONIC EDGE FINDERS

INSIZE PLUS
MADE IN EUROPE

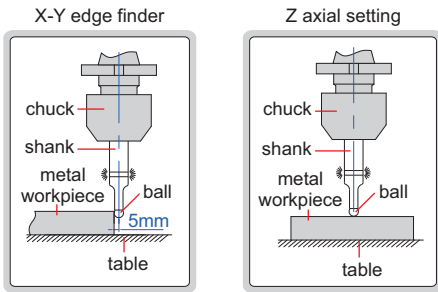

- The shank is electrically conducted to the metal workpiece through the chuck and table. The LED lights up, when the ball touches the workpiece
- Not suitable for rotary use
- Hardened contact ball

Code	Shank	Contact ball	Accuracy	Battery
6571-1	Ø16mm	SØ10mm	10µm	23A, 12V×1 pc
6571-2	Ø20mm	SØ10mm	10µm	23A, 12V×1 pc

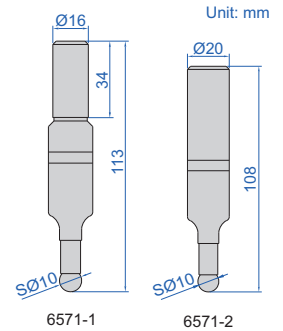

LARGE SHANK ELECTRONIC EDGE FINDERS

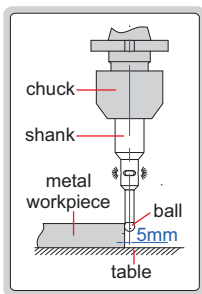

- The shank is electrically conducted to the metal workpiece through the chuck and table. The LED lights up and the beeper sounds (only for 6572-2), when the ball touches the workpiece
- Not suitable for rotary use
- Hardened shank and contact ball

Code	Shank (A)	Contact ball (B)	Accuracy	Beeper	Battery
6572-1	Ø32mm	SØ10mm	5µm	without	23A, 12V×1 pc
6572-2	Ø32mm	SØ10mm	5µm	with	23A, 12V×1 pc

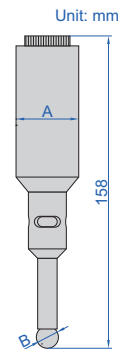

ELECTRONIC EDGE FINDERS

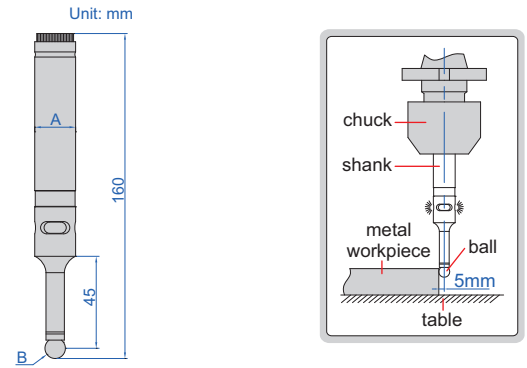

- The shank is electrically conducted to the metal workpiece through the chuck and table. The LED lights up and the beeper sounds (only for **6566-3**), when the ball touches the workpiece
- Not suitable for rotary use
- Hardened shank and contact ball

Code	Shank (A)	Contact ball (B)	Accuracy	Beeper	Battery
6566-2	Ø20mm	SØ10mm	5µm	without	23A, 12V×1 pc
6566-3	Ø20mm	SØ10mm	5µm	with	23A, 12V×1 pc

NON-MAGNETIC EDGE FINDERS

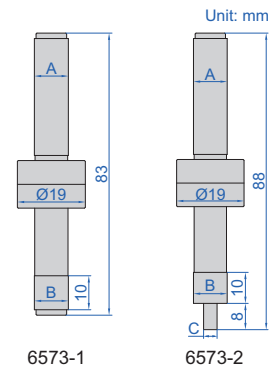

- TiAlN coating, non-magnetic, hardness HV2500, extremely wear resistance
- Suitable for machine speed 400~600rpm

Code	Shank (A)	Contact point (B)	Contact point (C)	Accuracy
6573-1	Ø10mm	Ø10mm	—	5µm
6573-2	Ø10mm	Ø10mm	Ø4mm	5µm

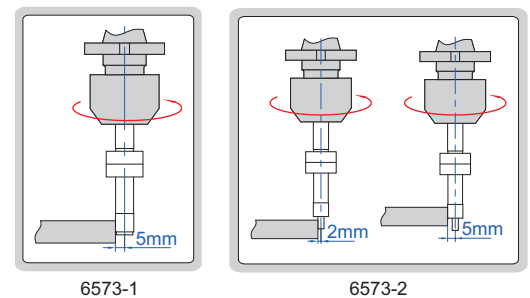

EDGE FINDERS

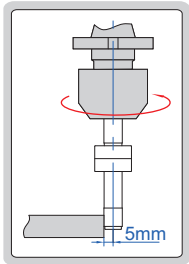

6562-3

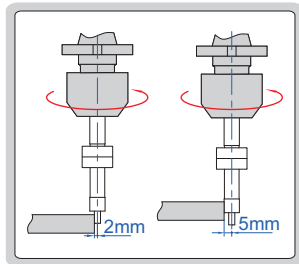

6562-4



6562-3

6562-4

- Hardened shank and contact point
- Suitable for machine speed 400~600rpm

Code	Shank (A)	Contact point (B)	Contact point (C)	Accuracy
6562-3	Ø10mm	Ø10mm	—	5µm
6562-4	Ø10mm	Ø10mm	Ø4mm	5µm

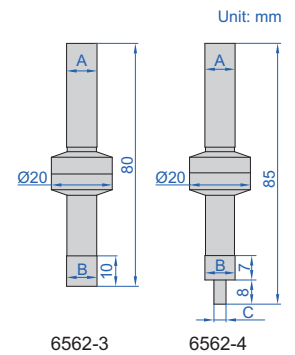

EDGE FINDER

- Hardened shank and contact point
- Suitable for machine speed 400~600rpm

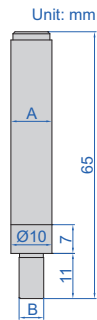

6567-1

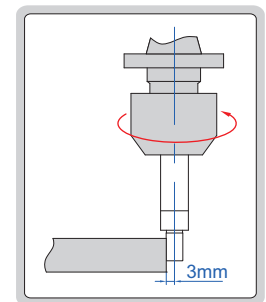

Code	Shank (A)	Contact point (B)	Accuracy
6567-1	Ø10mm	Ø6mm	8µm

CERAMIC EDGE FINDER

- Ceramic contact point, non magnetic
- Suitable for machine speed 400~600rpm

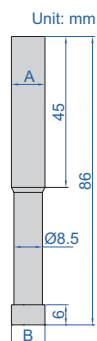

6568-1

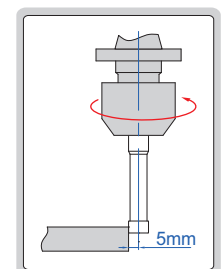

Code	Shank (A)	Contact point (B)	Accuracy
6568-1	Ø10mm	Ø10mm	8µm

EDGE FINDERS FOR EDM

CAN BE
CUSTOM-MADE



spindle type

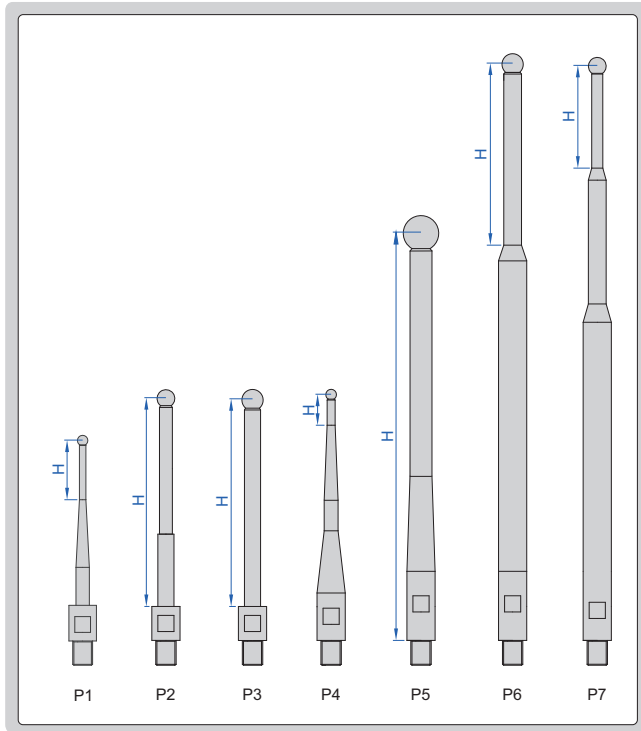

6558-52

- To locate workpieces
- Buzzer in EDM sounds when the ball touches the workpiece
- Tungsten steel ball, diameter accuracy: $\pm 0.003\text{mm}$
- Non magnetic stainless steel spindle
- Magnetic base

(mm)

Code	Ball dia. (SØD)	Spindle length (L)	Measuring depth (H)	Spindle type
6558-11	SØ1	69	5	P4
6558-21	SØ2	49	6	P1
6558-22	SØ2	69	6	P4
6558-23	SØ2	119	8	P4
6558-31	SØ3	48	6	P1
6558-32	SØ3	68	7	P4
6558-33	SØ3	118	10	P4
6558-41	SØ4	48	37	P3
6558-42	SØ4	68	57	P2
6558-43	SØ4	118	16	P4
6558-44	SØ4	168	28	P7
6558-51	SØ5	47	36	P3
6558-52	SØ5	67	56	P2
6558-53	SØ5	117	106	P2
6558-54	SØ5	167	46	P6
6558-61	SØ6	47	35	P3
6558-62	SØ6	67	56	P3
6558-63	SØ6	87	76	P3
6558-64	SØ6	117	107	P2
6558-65	SØ6	167	51	P6
6558-81	SØ8	46	46	P5
6558-82	SØ8	66	54	P3
6558-83	SØ8	116	105	P3
6558-84	SØ8	166	51	P6
6558-101	SØ10	45	34	P3
6558-102	SØ10	65	53	P3
6558-103	SØ10	115	114	P5
6558-104	SØ10	165	53	P6

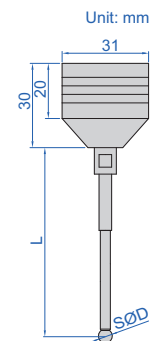

TRIGGER-TYPE 3D PROBE (AUDIBLE AND VISUAL ALARM) CODE 9410

IP67
WATERPROOF



type-C charging cable (included)



signal extension cord (included)



- Suitable for all kinds of machining centers, CNC boring machines, milling machines, drilling and tapping centers
- Suitable for workpiece detection of various solid materials
- Manually set the workpiece coordinates and machining reference points before CNC machining process
- In the process of CNC machining, manually detect and control key dimensions and position coordinates and their accuracy
- Detect the accuracy of the key size, shape and position of the workpiece after completion of CNC machining
- Standard Ø20mm shank diameter, held by CNC
- LED indicator and buzzer indicate the trigger state of the probe
- Using lithium battery charging technology, no need to replace the battery
- The battery (5% utilization rate per shift) can be used continuously for 90 days
- Type-C interface
- Optional accessory: styli and extension bar

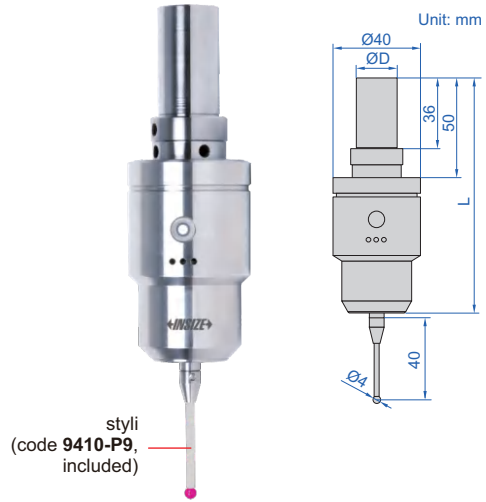

SPECIFICATION

Probe length (L)	115.5mm
Shank diameter (ØD)	20mm
Trigger direction	±X, ±Y, +Z
Directional trigger protection stroke	X-Y: ±12°, Z: +5mm
Arbitrary one-way repeated trigger accuracy	≤1µm
Trigger force in X-Y direction (with standard styli)	0.3-0.6N
Trigger force in Z direction	4N
Dust/waterproof	IP67
Type-C charging cable	1.5m
Signal extension cord (provide signals to CNC)	1m

application

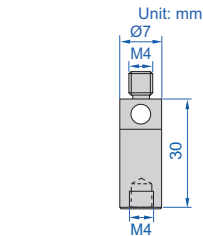
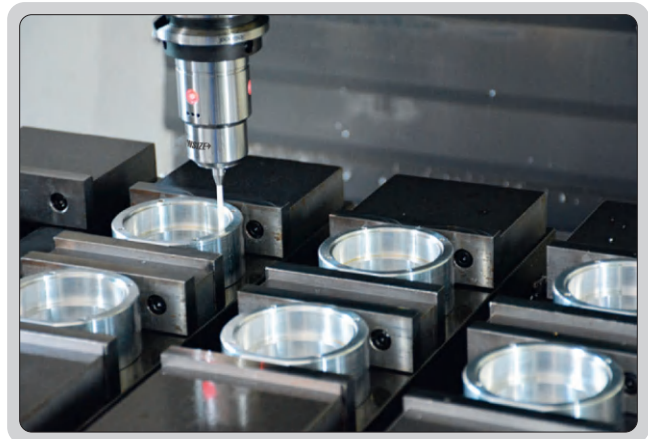

EXTENSION ROD (OPTIONAL)

Code	Material
9410-R1	ceramic

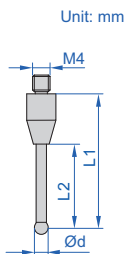

STYLI (OPTIONAL)

(mm)

Code	L1	L2	Ød	Material of rod *	Material of ball
9410-P1	18	13	4	stainless steel	ruby
9410-P2	18	13.5	5	stainless steel	ruby
9410-P3	18.5	13	3	stainless steel	ruby
9410-P4	19	8	2	carbide	ruby
9410-P5	19.5	4	1	carbide	ruby
9410-P6	50	40	2	carbide	ruby
9410-P7	50	34	5	ceramic	ruby
9410-P8	100	86	6	ceramic	ruby
9410-P9	40	30	4	ceramic	ruby
9410-P10	50	36	6	ceramic	ruby

* For stainless steel or carbide rods, it is recommended to use extension rods to protect spindles in case of break

IP68
WATERPROOF

RADIO TRANSMISSION PROBES FOR CNC MACHINE TOOLS

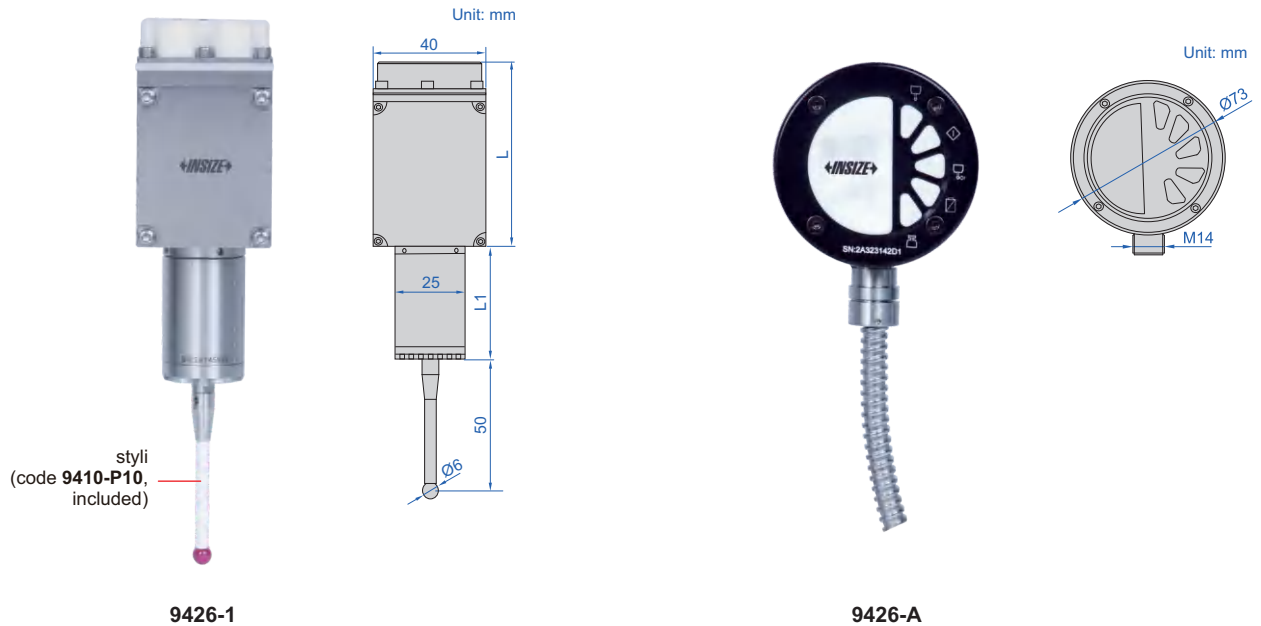

- On-machine measurement of all kinds of lathes, turning centers and mill-turn CNC machines tools
- Automatically set the workpiece coordinate and machining reference point before CNC machining process
- Automatically measure dimension and position coordinate during CNC machining
- Measure dimension, shape and position after CNC machining is completed
- Four kinds of SSR signals such as probe status, error, low voltage and pulse are transmitted to CNC machine tools
- M code is used to control on or off of probes
- Radio transmission, transmission/reception range: 14m
- Supplied with measurement software
- Optional accessory: styli
- Mounting plate can be customized

probe extension rod
(included)



PROBE SPECIFICATION

Code	9426-1	9426-2	9426-3	9426-4
Signal transmitter length (L)	67mm	67mm	67mm	67mm
Probe length (L1)	42mm	42mm	42mm	42mm
Probe extension rod (included)	—	50mm	100mm	150mm
Trigger accuracy of styli in any direction	1μm			
Protection stroke triggered by styli in all directions	X and Y axis stroke: ±12°, Z axis stroke: 5mm			
Trigger force of styli in all directions	X and Y axis: <1.6N, Z axis: <9.8N			
Dust/waterproof	IP68			
Power supply	2×LS14250 lithium battery			

RECEIVER SPECIFICATION

Code	9426-A
Protection function	low battery voltage or probe transmitting signal all the time*
Applicable probe	code 9426-1, 9426-2, 9426-3, 9426-4
Cable length**	8m
Dust/waterproof	IP68
Power supply	input voltage: 24V±10%(DC), load current: 50mA

* When battery voltage is low or probe is in wrong state, receiver sends a signal to CNC machine to stop working

** Cable length can be customized

To be continued

Continued from previous page

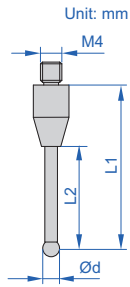

STYLI (OPTIONAL)

(mm)

Code	L1	L2	Ød	Material of rod***	Material of ball
9410-P1	18	13	4	stainless steel	ruby
9410-P2	18	13.5	5	stainless steel	ruby
9410-P3	18.5	13	3	stainless steel	ruby
9410-P4	19	8	2	carbide	ruby
9410-P5	19.5	4	1	carbide	ruby
9410-P6	50	40	2	carbide	ruby
9410-P7	50	34	5	ceramic	ruby
9410-P8	100	86	6	ceramic	ruby
9410-P9	40	30	4	ceramic	ruby
9410-P10	50	36	6	ceramic	ruby

*** For stainless steel or carbide rods, it is recommended to use extension rods to protect spindles in case of break

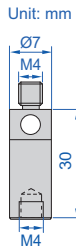

EXTENSION ROD (OPTIONAL)

Code	Material
9410-R1	ceramic

application

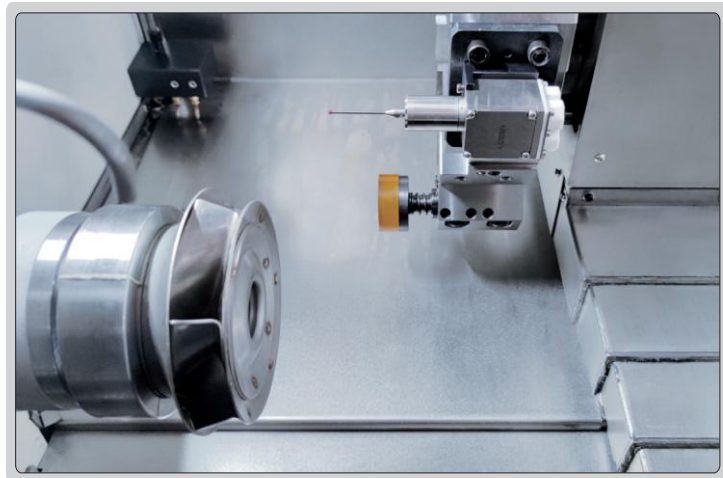

MEASUREMENT SOFTWARE (INCLUDED)

1. Styli automatic calibration
2. Protection of stylus during probe movement (avoid collision)
3. Groove and boss measurement

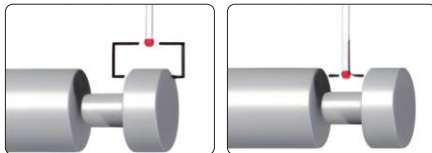

4. Bore and axis measurement

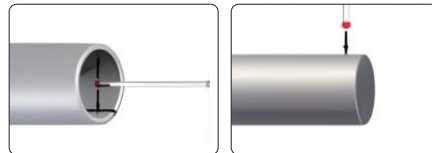

5. Measurement of X and Y axis step plane
6. Measurement of X and Y plane angle
7. Measurement of internal arc in X and Y plane



INFRARED TRANSMISSION PROBES FOR CNC MACHINE TOOLS

IP68
WATERPROOF

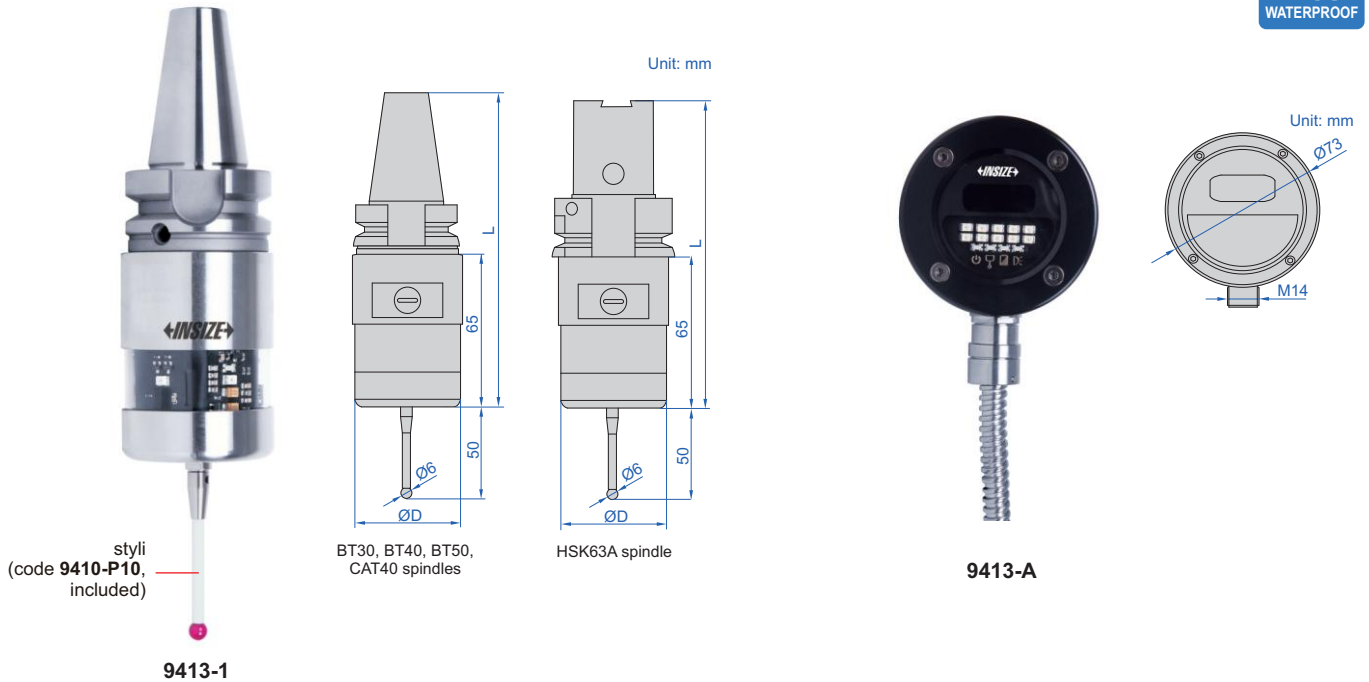

stylus
(code 9410-P10,
included)

9413-1

BT30, BT40, BT50,
CAT40 spindles

HSK63A spindle

9413-A



- On-machine measurement of all kinds of small and medium-sized machining centers, CNC boring, milling machines and five-axis CNC machine tools
- Automatically set the workpiece coordinate and machining reference point before CNC machining process
- Automatically measure dimension and position coordinate during CNC machining
- Measure dimension, shape and position after CNC machining is completed
- Four kinds of SSR signals such as probe status, error, low voltage and pulse are transmitted to CNC machine tools
- M code is used to control on or off of probes
- Infrared transmission, strong anti-interference
- Infrared transmission/reception range: 5m
- Supplied with automatic measurement software
- Optional accessory: styli

PROBE SPECIFICATION

Code	9413-1	9413-2	9413-3	9413-4	9413-5
Probe length (L)	140mm	166mm	216mm	168mm	136mm
Probe diameter (ØD)	48mm	48mm	48mm	48mm	48mm
Applicable spindle *	BT30	BT40	BT50	CAT40	HSK63A
Trigger accuracy of styli in any direction	1µm				
Protection stroke triggered by styli in all directions	X and Y axis stroke: ±12.5°, Z axis stroke: 5mm				
Trigger force of styli in all directions	X and Y axis: 1-1.6N, Z axis: 5-10N				
Dust/waterproof	IP68				
Power supply	2×LS14250 lithium battery				

* SK and ISO spindle probes also can be customized

RECEIVER SPECIFICATION

Code	9413-A
Protection function	low battery voltage or probe transmitting signal all the time**
Applicable probe	code 9413-1, 9413-2, 9413-3, 9413-4, 9413-5
Cable length	8m
Dust/waterproof	IP68
Power supply	input voltage: 24V±10% (DC), load current: 50mA

** When battery voltage is low or probe is in wrong state, receiver sends a signal to CNC machine to stop working

To be continued

Continued from previous page

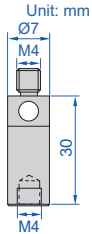
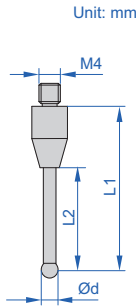

EXTENSION ROD (OPTIONAL)

Code	Material
9410-R1	ceramic

STYLI (OPTIONAL)

(mm)

Code	L1	L2	Ød	Material of rod ***	Material of ball
9410-P1	18	13	4	stainless steel	ruby
9410-P2	18	13.5	5	stainless steel	ruby
9410-P3	18.5	13	3	stainless steel	ruby
9410-P4	19	8	2	carbide	ruby
9410-P5	19.5	4	1	carbide	ruby
9410-P6	50	40	2	carbide	ruby
9410-P7	50	34	5	ceramic	ruby
9410-P8	100	86	6	ceramic	ruby
9410-P9	40	30	4	ceramic	ruby
9410-P10	50	36	6	ceramic	ruby

*** For stainless steel or carbide rods, it is recommended to use extension rods to protect spindles in case of break

application

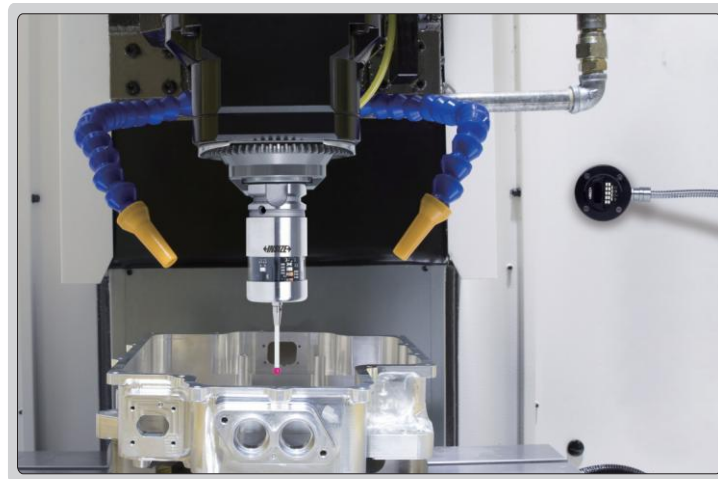

AUTOMATIC MEASUREMENT SOFTWARE (INCLUDED)

1. Stylus automatic calibration
2. Protection of stylus during probe movement (avoid collision)
3. Groove and boss measurement

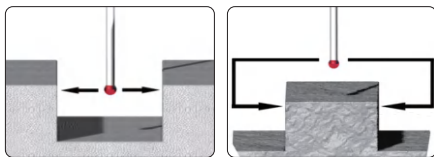

5. X or Y single-surface measurement

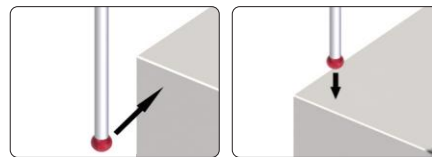

7. 4th axis measurement
8. Angle on X and Y plane measurement
9. Three points measurement of arc

4. Bore and axis measurement

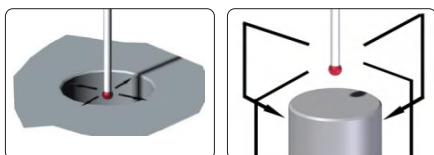

6. Internal and external corner measurement

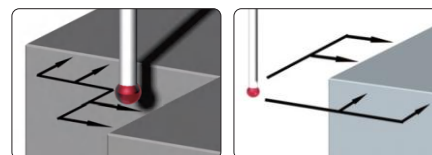

10. Measure the distance between two holes

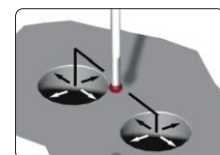

INFRARED TRANSMISSION PROBES FOR CNC MACHINE TOOLS (CAN BE USED IN COMBINATION WITH ZERO SETTER WITH INFRARED TRANSMISSION)



IP68
WATERPROOF

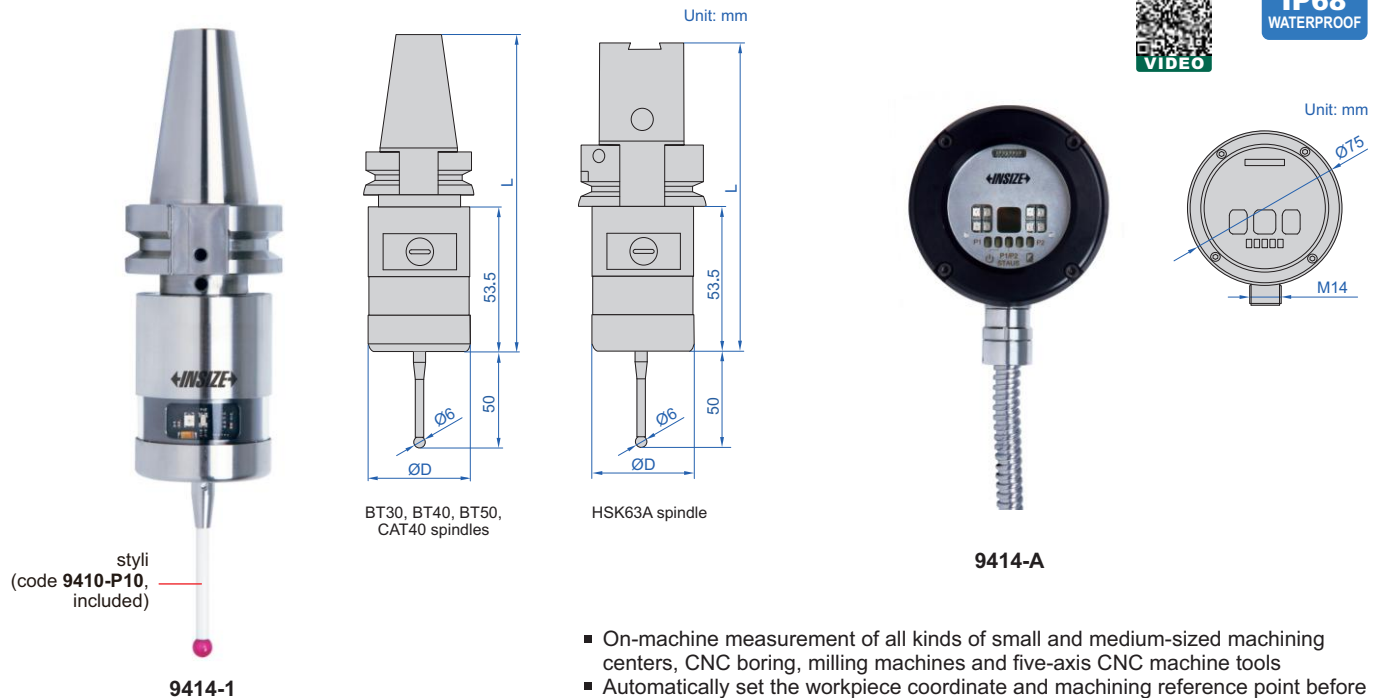

styli
(code 9410-P10,
included)

9414-1

BT30, BT40, BT50,
CAT40 spindles

HSK63A spindle

9414-A



- On-machine measurement of all kinds of small and medium-sized machining centers, CNC boring, milling machines and five-axis CNC machine tools
- Automatically set the workpiece coordinate and machining reference point before CNC machining process
- Automatically measure dimension and position coordinate during CNC machining
- Measure dimension, shape and position after CNC machining is completed
- Four kinds of SSR signals such as probe status, error, low voltage and pulse are transmitted to CNC machine tools
- Working status can be displayed on receiver LED indicator
- Signal transmitting range of probe can be set
- Infrared transmission, fast response, high reliability
- The battery (5% utilization rate per shift) can be used continuously for 90 days
- Supplied with measurement software package
- Can be used in combination with zero setter with infrared transmission (code 9415-1, 9415-2)
- Optional accessory: styli

PROBE SPECIFICATION

Code	9414-1	9414-2	9414-3	9414-4	9414-5
Probe length (L)	130mm	151.5mm	208.3mm	156mm	126.5mm
Probe diameter (ØD)	40mm	40mm	40mm	40mm	40mm
Applicable spindle *	BT30	BT40	BT50	CAT40	HSK63A
Trigger accuracy of styli in any direction	1µm				
Protection stroke triggered by styli in all directions	X and Y axis stroke: ±12°, Z axis stroke: 5mm				
Trigger force of styli in all directions	X and Y axis: 0.5-1N, Z axis: 7.5N				
Dust/waterproof	IP68				
Power supply	2×LS14250 lithium battery				

* SK and ISO spindle probes also can be customized

RECEIVER SPECIFICATION

Code	9414-A
Protection function	low battery voltage, overstroke and signal interrupt protection**
Applicable	probe code 9414-1, 9414-2, 9414-3, 9414-4, 9414-5; zero setter code 9415-1, 9415-2
Infrared transmission/reception range	3m
Cable length	8m
Dust/waterproof	IP68
Power supply	input voltage: 24V±10% (DC), load current (max): 50mA

** When battery voltage is low or zero setter is in wrong state, receiver sends a signal to CNC machine to stop working

To be continued

Continued from previous page

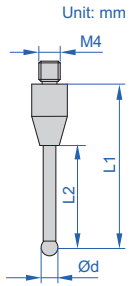

STYLI (OPTIONAL)

(mm)

Code	L1	L2	Ød	Material of rod ***	Material of ball
9410-P1	18	13	4	stainless steel	ruby
9410-P2	18	13.5	5	stainless steel	ruby
9410-P3	18.5	13	3	stainless steel	ruby
9410-P4	19	8	2	carbide	ruby
9410-P5	19.5	4	1	carbide	ruby
9410-P6	50	40	2	carbide	ruby
9410-P7	50	34	5	ceramic	ruby
9410-P8	100	86	6	ceramic	ruby
9410-P9	40	30	4	ceramic	ruby
9410-P10	50	36	6	ceramic	ruby

*** For stainless steel or carbide rods, it is recommended to use extension rods to protect spindles in case of break

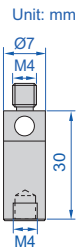

EXTENSION ROD (OPTIONAL)

Code	Material
9410-R1	ceramic

application

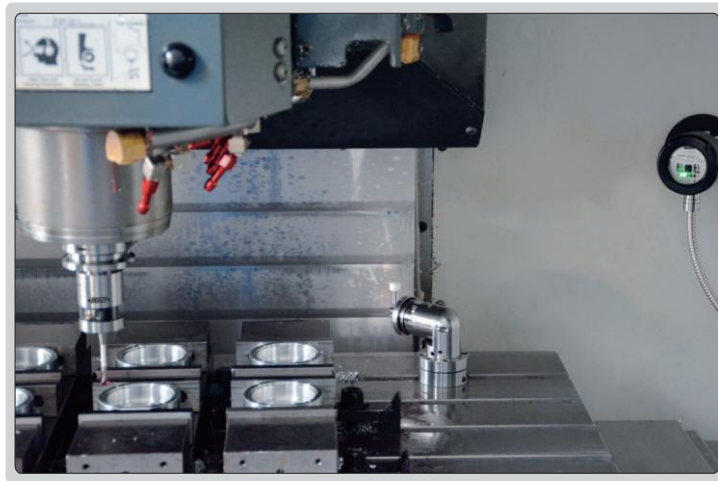

AUTOMATIC MEASUREMENT SOFTWARE (INCLUDED)

1. Stylus automatic calibration
2. Protection of stylus during probe movement (avoid collision)
3. Groove and boss measurement

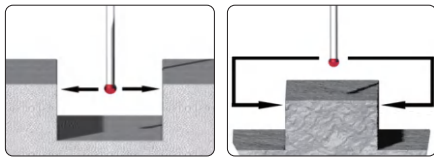

4. Bore and axis measurement

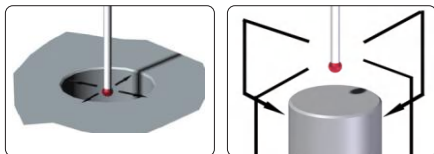

5. X or Y single-surface measurement

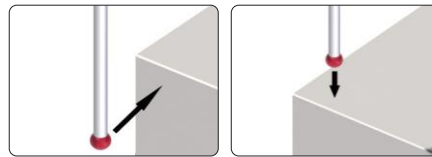

6. Internal and external corner measurement

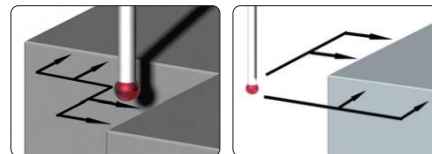

7. 4th axis measurement
8. Angle on X and Y plane measurement
9. Three points measurement of arc

10. Measure the distance between two holes



IP68
WATERPROOF

ZERO SETTER WITH INFRARED TRANSMISSION (FIVE-SIDE)



9415-1



9414-A

Unit: mm

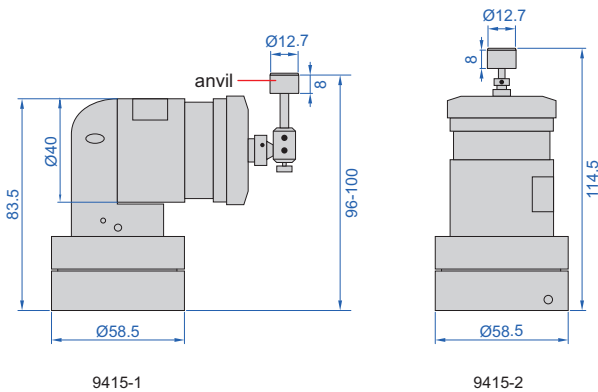

Unit: mm

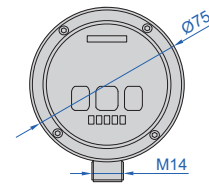

- Suitable for all kinds of small and medium-sized machining centers, CNC boring, milling machines and five-axis CNC machine tools, etc.
- Automatically set the tool length parameters before CNC machining process
- Automatic detection of tool wear or damage during CNC machining
- Automatic detection of tool wear or damage after CNC machining is completed
- The working surface of anvil is ceramic and has chamfer, which can greatly improve the service life
- Infrared transmission, fast response, high reliability
- The battery (5% utilization rate per shift) can be used continuously for 90 days
- Supplied with automatic zero setter software package
- Can be used in combination with infrared transmission probes for CNC machine tools (code 9414-1, 9414-2, 9414-3, 9414-4, 9414-5)
- Optional accessory: square anvil (code 9412-B1)

ZERO SETTER SPECIFICATION

Code	9415-1	9415-2
Height (factory setting)	96-100mm	114.5mm
Diameter of zero setter	Ø12.7mm	
Trigger direction	±X, ±Y, +Z	
Trigger protection stroke	X-Y: ±5mm, Z: 8mm	
Trigger force of zero setter all directions	X and Y axis: 0.5-1N, Z axis: 1.5N	X and Y axis: 0.5-1N, Z axis: 5N
Repeated trigger accuracy	≤1µm	
Start/stop mode	M code control *	
Hardness of the zero setter	HM8.5	
Dust/waterproof	IP68	
Power supply	2×LS14250 lithium battery	

* Before purchasing, please confirm whether CNC still has enough M code to be used

To be continued

Continued from previous page

RECEIVER SPECIFICATION

Code	9414-A
Protection function	low battery voltage, overstroke and signal interrupt protection**
Applicable	probe code 9414-1, 9414-2, 9414-3, 9414-4, 9414-5 ; zero setter code 9415-1, 9415-2
Infrared transmission/reception range	3m
Cable length	8m
Dust/waterproof	IP68
Power supply	input voltage: 24V±10% (DC), load current (max): 50mA

** When battery voltage is low or zero setter is in wrong state, receiver sends a signal to CNC machine to stop working

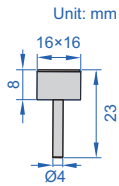

SQUARE ANVIL (OPTIONAL)

Code	Shape	Dimension	Material
9412-B1	square	16×16mm	ceramic

application

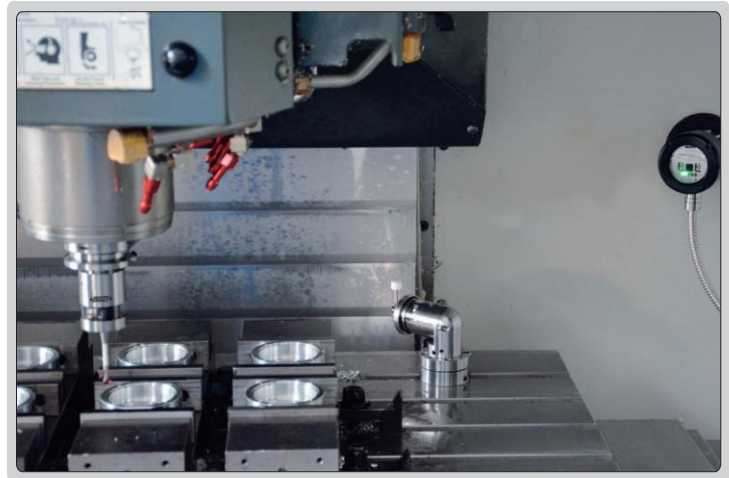

Automatic zero setter software (included)

1. Automatic calibration of the center position of the anvil
2. Standard knife length setting
3. Semi-automatic and fully automatic tool setting for tool length



4. Semi-automatic and fully automatic tool diameter settings



5. Automatic detection of tool wear and breakage





IP68
WATERPROOF

ZERO SETTER WITH CABLE (FIVE-SIDE) CODE 9412

- Suitable for various machining centers, CNC boring and milling machines, etc.
- Automatically set the tool length parameters before CNC machining process
- Automatic detection of tool wear or damage during CNC machining
- Automatic detection of tool wear or damage after CNC machining is completed
- The working surface adopts ceramic material and chamfering process, which can greatly improve the service life
- The plug, cable part and output signal of the host are protected, so that the zero setter can work in the splash environment for a long time
- Signal transmission through the cable, the reverse connection of the power line can change the state of the signal output
- The working status is displayed by the indicator light
- Supplied with automatic zero setter software package
- Optional accessory: square feeler block (code **9412-B1**)



SPECIFICATION

Height (factory setting)	80±0.5mm
Diameter of zero setter	Ø12.7mm
Trigger direction	±X, ±Y, +Z
Trigger protection stroke	X-Y: ±5mm, Z: 8mm
Axial reset force	3.4N-3.6N
Repeated trigger accuracy	≤1µm
Hardness of the zero setter	HM8.5
Class of protection	IP68
Cable length *	6m (stainless steel sheath 3m)
Input voltage	24V±10% (DC)
Load current	max: 50mA
Signal type and logic **	SSR (NC/NO)

*The length of the cable can be customized

**Before purchasing, it is necessary to confirm whether the working logic of the tool setter output signal matches CNC control system

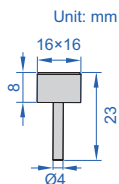
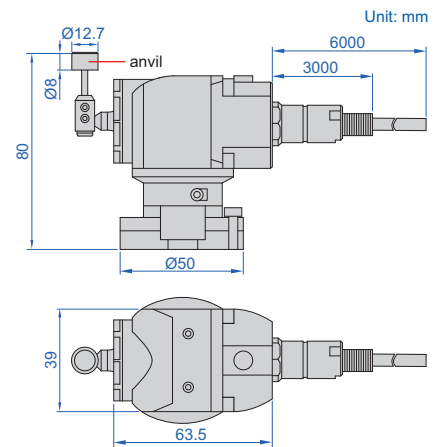

SQUARE ANVIL (OPTIONAL)

Code	Shape	Dimension	Material
9412-B1	square	16×16mm	ceramic

application



Automatic zero setter software (included)

1. Automatic calibration of the center position of the anvil
2. Standard knife length setting
3. Semi-automatic and fully automatic tool setting for tool length



4. Semi-automatic and fully automatic tool diameter settings



5. Automatic detection of tool wear and breakage



ZERO SETTER (WITH CABLE) CODE 9411

IP68
WATERPROOF



- Suitable for various machining centers, CNC boring and milling machines, etc.
- Automatically set the tool length parameters before CNC machining process
- Automatic detection of tool wear or damage during CNC machining
- Automatic detection of tool wear or damage after CNC machining is completed
- The working surface is made of hard alloy material, which can greatly improve the scratch resistance
- Signal transmission through the cable, the reverse connection of the power line can change the state of the signal output
- The working status is displayed by the indicator light
- Supplied with 20mm mounting base
- Supplied with automatic zero setter software package
- Optional accessory: blow-cleaning device (code **9411-C1**)



mounting base
(included)

SPECIFICATION

Height	80mm (the height is 100mm after adding the mounting base)
Diameter of zero setter	Ø25mm
Downward travel	5mm
Axial reset force	6N±0.3N
Repeated trigger accuracy	≤1µm
Hardness of the zero setter	HRA90-93
Class of protection	IP68
Cable length *	6m (stainless steel sheath 3m)
Input voltage	24V±10% (DC)
Load current	max: 50mA
Signal type and logic **	SSR (NC/NO)

*The length of the cable can be customized

**Before purchasing, it is necessary to confirm whether the working logic of the tool setter output signal matches CNC control system

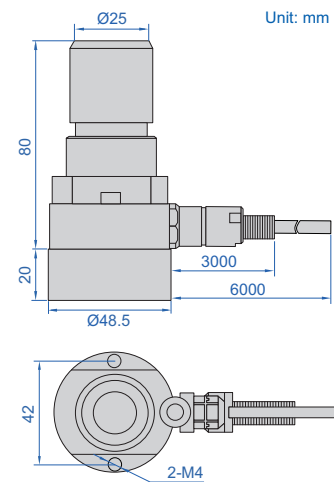

BLOW-CLEANING DEVICE (OPTIONAL)

Code	Material
9411-C1	stainless steel

Before purchasing a blow-cleaning device, it is necessary to confirm whether CNC machine has the M-code to control the cleaning

application



blow-cleaning device (optional)

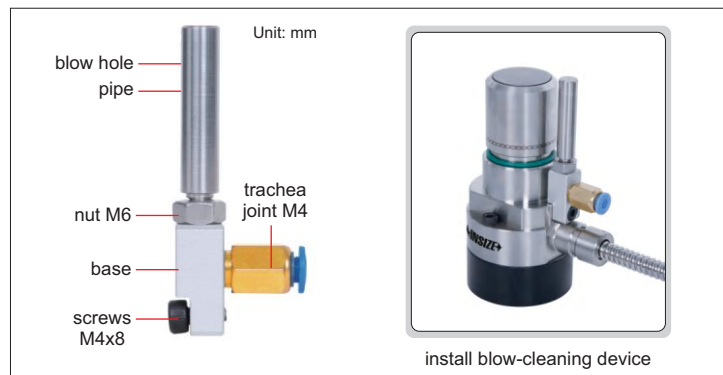

install blow-cleaning device

Automatic zero setter software package (included)

1. Automatic calibration of the center position of the cutter block
2. Standard knife length setting
3. Semi-automatic and fully automatic tool setting for tool length
4. Automatic detection of tool wear and breakage



LOW TEST FORCE

- The base is electrically conducted to the cutting tools through the table and chuck. The LED lights up when the cutting tool touches the anvil
- Magnetic base
- Two batteries LR44

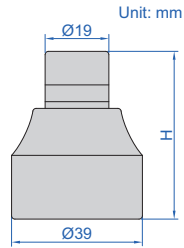

6553-50

ELECTRONIC ZERO SETTER

INSIZE PLUS
MADE IN EUROPE

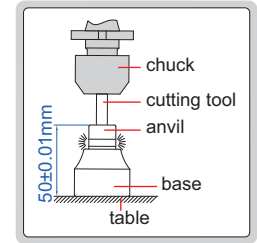
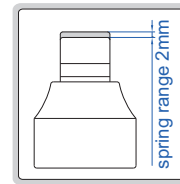

Code	Height (H)	Accuracy	Test force
6553-50	50mm	±10µm	7N (at 49mm)

IP65 WATERPROOF

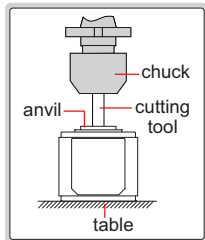

6557-50



DIGITAL ZERO SETTER

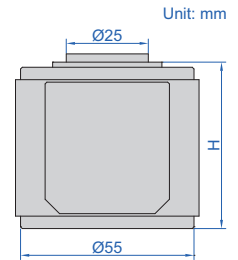

- Resolution: 0.001mm/0.00005"
- IP65 dust/waterproof
- Buttons: on/off, mm/inch, zero
- CR2032 battery
- Automatic power off
- Magnetic base
- Automatic backlight at zero

Code	Height (H)	Anvil stroke	Accuracy *	Test force	Repeatability
6557-50	50mm	2.5mm	±10µm/0.0004"	10N (at 50mm)	2µm

* The accuracy is ensured within Ø10mm of the center

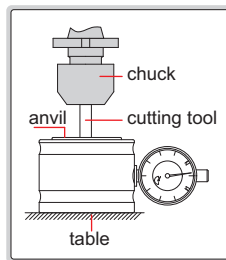
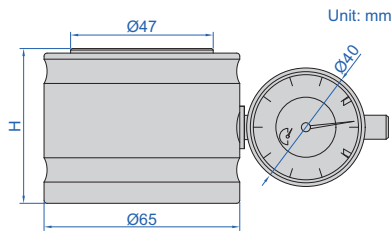

6554-50

ZERO SETTER

INSIZE PLUS
MADE IN EUROPE

Code	Height (H)	Graduation	Accuracy	Test force
6554-50	50mm	0.01mm	±0.02mm	9N (at 50mm)

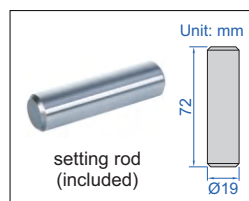
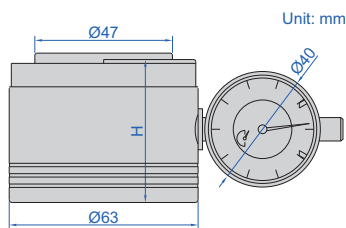

6556-50

ZERO SETTER

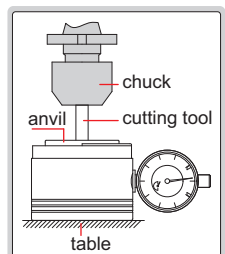

Code	Height (H)	Graduation	Accuracy	Test force
6556-50	50mm	0.01mm	±0.01mm	10N (at 50mm)

ZERO SETTER

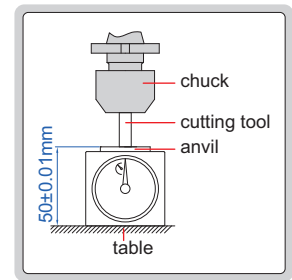
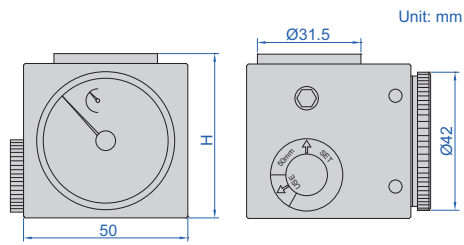

- Magnetic base

2397-502A

Code	Height (H)	Graduation	Accuracy	Test force
2397-502A	50mm	0.01mm	±0.01mm	9N (at 50mm)

ZERO SETTER

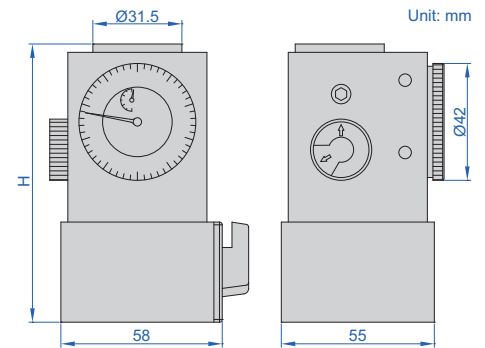
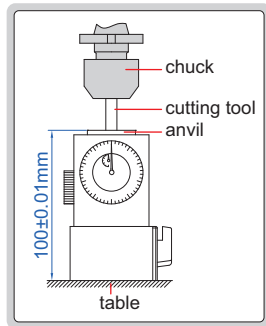

- Magnetic base with on-off switch

2394-100A

Code	Height (H)	Graduation	Accuracy	Test force
2394-100A	100mm	0.01mm	±0.01mm	9N (at 100mm)

LOW TEST FORCE ZERO SETTER

INSIZE PLUS
MADE IN EUROPE

LOW TEST FORCE

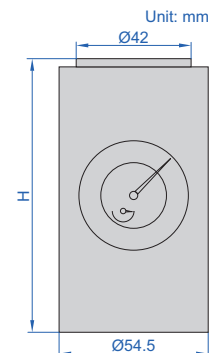
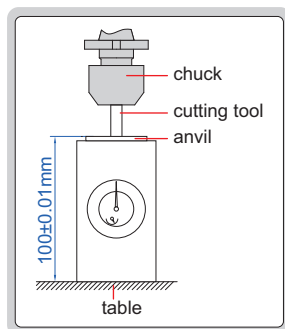

- Magnetic base
- Low test force, suitable for micro tools with minimum diameter Ø0.1mm

6555-100B

Code	Height (H)	Graduation	Accuracy	Test force
6555-100B	100mm	0.01mm	±0.01mm	1N (at 100mm)



VIDEO



2257-10

- Used to detect and adjust the perpendicularity between the spindle and worktable of a vertical milling machine

Code	Indicator	Accuracy
2257-10	dial indicator, code 2301-10F, range: 10mm, graduation: 0.01mm	5 μ m

VERTICAL MILLING MACHINE PERPENDICULARITY MEASURING GAUGE

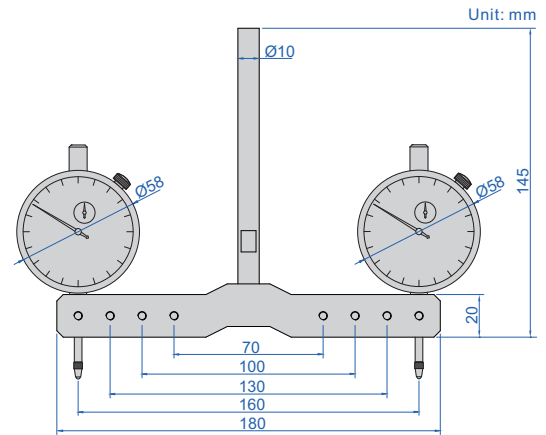

VIDEO



2258-101

- Used to detect and adjust the perpendicularity between the spindle and worktable of a vertical milling machine

Code	Indicator	Accuracy
2258-101	digital indicator, code 2112-101F, range: 12.7mm/0.5", resolution: 0.001mm/0.00005"	3 μ m

VERTICAL MILLING MACHINE PERPENDICULARITY MEASURING GAUGE

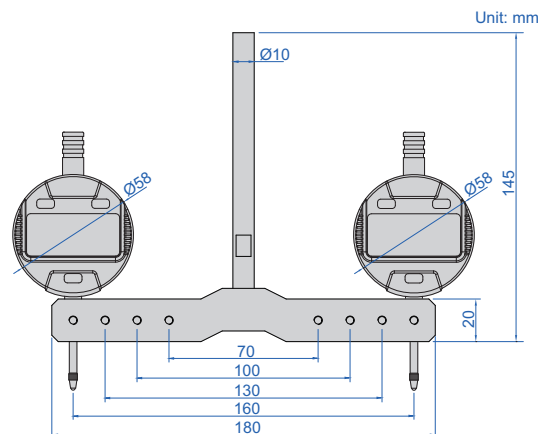



Electronic Levels
Page 538-539



Digital Levels And Slope Meters
Page 540-545



Frame Levels
Page 545-546



Block Levels
Page 546-547



Levels
Page 548-551



Cross-Line Laser Levels
Page 552



Self-Leveling Rotary Lasers
Page 553

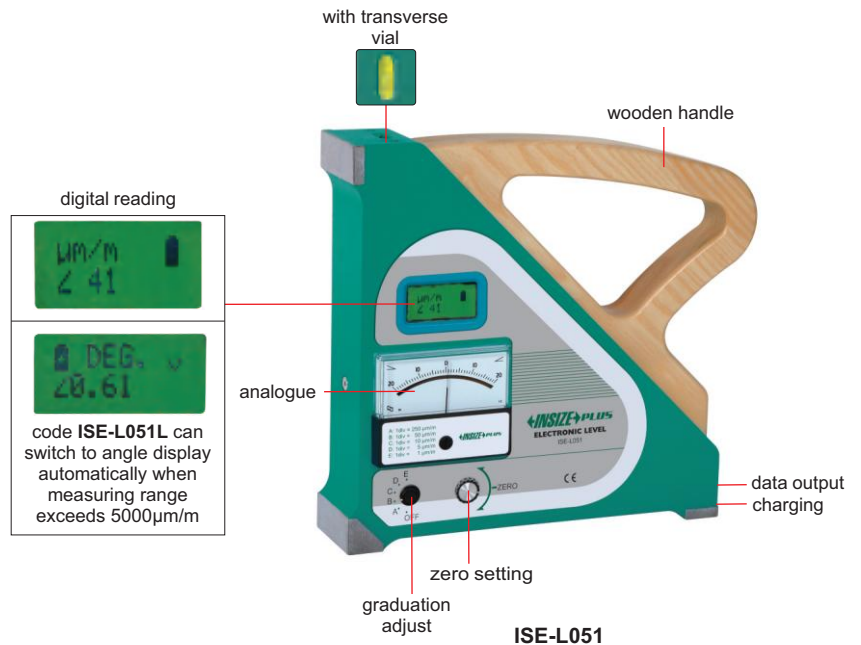
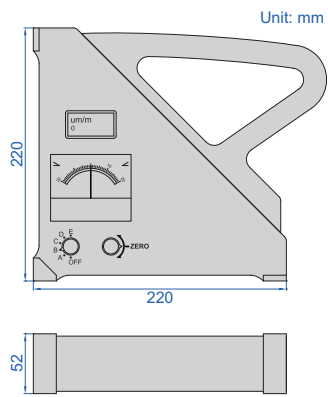

- Shockproof
- Analogue and digital reading modes

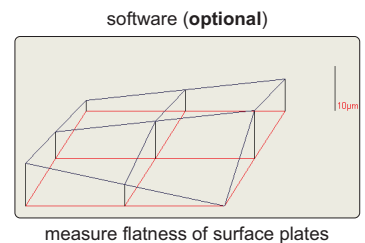
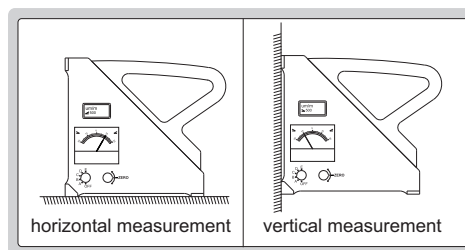
SPECIFICATION

Code	ISE-L051			ISE-L051L	
	Analogue graduation (adjustable)	250µm/m (=0.014°)	50µm/m (=10")	10µm/m (=2")	5µm/m (=1")
Analogue range	±5000µm/m	±1000µm/m	±200µm/m	±100µm/m	±20µm/m
Digital reading resolution	horizontal: 1µm/m (=0.2")			horizontal: 1µm/m (=0.2"), angle: 0.01°	
Digital reading range	horizontal: 5000µm/m			horizontal: 5000µm/m, angle: 0.3~85°	
Accuracy	horizontal: ±1%			horizontal: ±1%, angle: ±0.7%	
Zero setting range	±1500µm/m				
Response time	<3s				
Data output	RS232				
Power supply	rechargeable Li-ion battery, provides power for 10h continuous working				
Dimension	220×220×52mm				
Weight	4.4kg				

STANDARD DELIVERY

Main unit	1 pc
AC/DC adapter	1 pc

OPTIONAL ACCESSORY

Software and data output cable	ISE-L050-SOFTWARE
--------------------------------	-------------------

WIRELESS ELECTRONIC LEVELS

measuring and analysis software (included)

straightness measuring and analysis

parallelism measuring and analysis

flatness measuring and analysis



4952-150

wireless receiver (included)



control box (included)



300mm bridge plate
4952-01 (optional)



- Measures flatness, parallelism and straightness
- Built-in wireless transmission module, 433MHz signal, wireless connection to computer, transmission distance 50m
- The LCD can be rotated for easy observation in different directions
- Designed with handle for easy access
- V-groove on bottom for shafts
- Supplied with measuring and analysis software
- Optional accessory: bridge plate (code 4952-01)

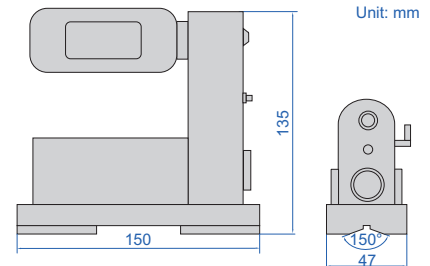

SPECIFICATION

Code	4952-150		4952-150L	
Resolution (adjustable)	0.001mm/m (0.2")	0.01mm/m (2")	0.005mm/m (1")	0.01mm/m (2")
Range	±0.5mm/m	±5mm/m	±2.5mm/m	±5mm/m
Repeatability	0.001mm/m	0.01mm/m	0.005mm/m	0.01mm/m
Response time	<10s	<3s	<5s	<3s
Accuracy	$\pm(1+A \times 2\%) \Delta^*$			
Power supply	1×21700 Li-ion battery, for 50h continuous working			
Weight	1.8kg			

* A is the measured value, Δ is the resolution

STANDARD DELIVERY

Main unit	1 pc
Wireless receiver	1 pc
Control box	1 pc
Measuring and analysis software (with dongle)	1 set
Charger	1 pc
21700 Li-ion battery	4 pcs



DATA OUTPUT

DIGITAL LEVEL CODE ISE-2DT



- Color LCD, touch panel
- X-Y axis measurement
- Set the tolerance and the display is shown in different colors



within the tolerance (green)

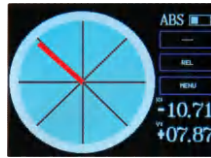

out of the tolerance (red)

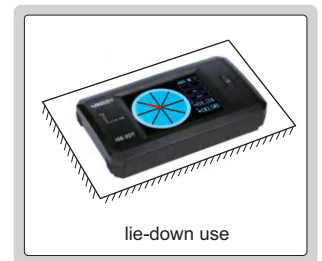

- To show the incline with line or bubble



charging and data output

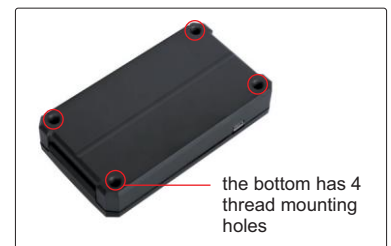

the bottom has 4 thread mounting holes

SPECIFICATION

Measuring range	±30°
Resolution	0.1°, 0.01°, 0.1mm/m
Accuracy	±0.03° (range 0~3°) ±0.05° (range >3°)
Power supply	rechargeable battery
Dimension	115×66×25mm
Weight	224g

STANDARD DELIVERY

Main unit	1 pc
USB cable	1 pc

OPTIONAL ACCESSORY

Software	ISE-2DT-SOFTWARE
----------	------------------

PC software (optional), send data to txt

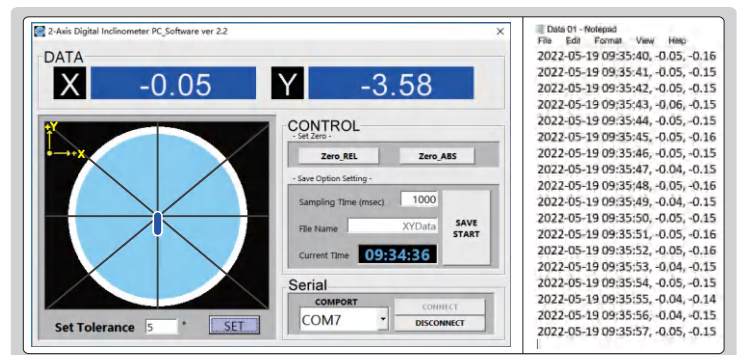

DUAL AXIS DIGITAL LEVEL AND GYRO ANGLE METER



DATA OUTPUT

DISPLAY FLIPS OVER WHEN THE BOTTOM FACES UP

AUDIBLE ALARM WHEN OUT OF LIMIT

BACKLIGHT

ATTENTION: HARD PLASTIC CASE



2199-1

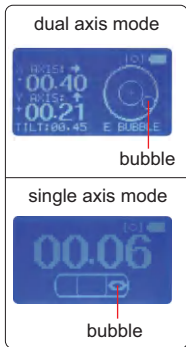
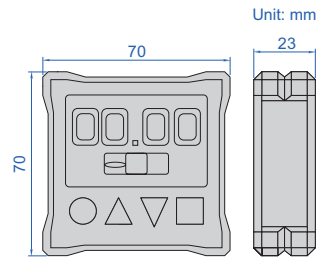

M4 threaded holes on the back for fixing

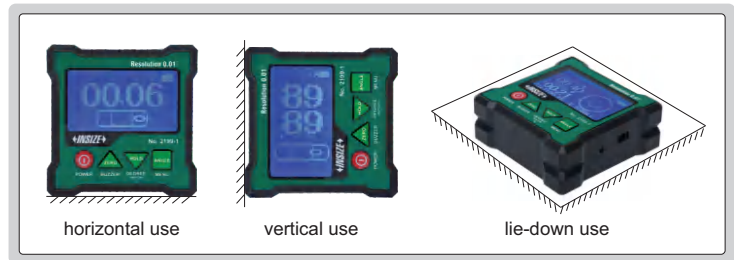

- Single axis/double axis level and slope meter, gyro technique can measure the angle between two planes in any direction
- Hard plastic case, with V-shaped grooves, four magnetic sides
- Display flips over when the bottom faces up
- Audible alarm when out of limit
- Buttons: POWER, ZERO, HOLD, display unit (°, mm/m, %), MENU
- Rechargeable Li-ion battery 3.7V, operation time is 40 hours
- Automatic power off in 30 minutes
- Data output
- Android and iPhone APP are included
- Optional accessory: wired data transmission (code **2199-A01**), bluetooth (code **2199-A02**), transmission distance is 10 meters (under the condition of no obstruction and no electromagnetic interference)

measurement of angle between two planes in any direction (gyro technique)

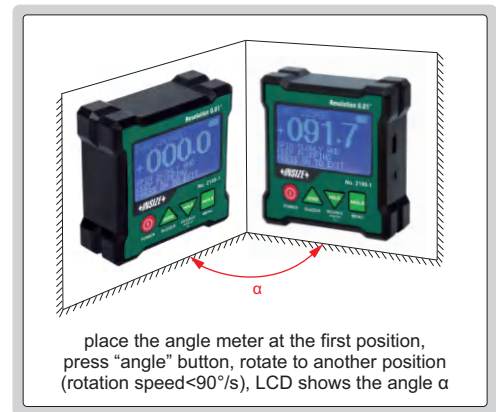

Code	Range	Resolution	Accuracy
2199-1	single axis level: $4 \times 90^\circ$ dual axis level: $\pm 40^\circ$	0.01°	at 0° and 20°: $\pm 0.08^\circ$ at 20° and 70°: $\pm 0.15^\circ$ at 70° and 90°: $\pm 0.08^\circ$
	gyro angle meter: 360°	0.1°	$\pm 0.5^\circ$

To be continued

Continued from previous page



bluetooth (optional)



wired data transmission (optional)



connect to computer via wired data transmission



connect to mobile phone via bluetooth

Android and iPhone APP (included), can choose real-time display (continuous transmission) or single transmission

Dual axis mode



INSIZE-2199-1
Collect unit:°

bubble

x=0.59 y=-29.86

Export Clear Collect

graph

Time	X Value	Y Value	Unit	Alarm
01-19 15:55:01	0.59	-29.86	*	LowMin
01-19 15:54:59	-3.49	-18.26	*	None
01-19 15:54:47	-6.16	-26.90	*	LowMin
01-19 15:54:46	30.22	-13.89	*	None

Single axis mode

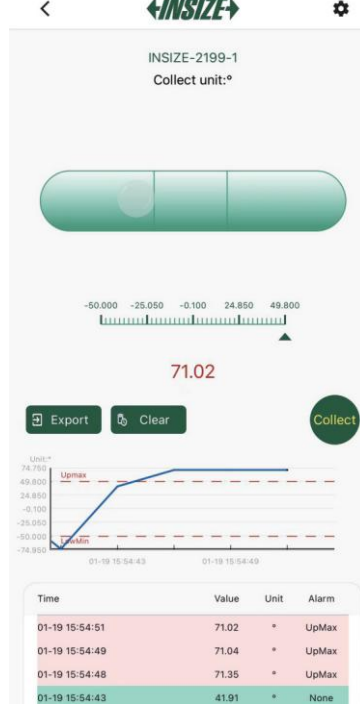

INSIZE-2199-1
Collect unit:°

71.02

Export Clear Collect

Time	Value	Unit	Alarm
01-19 15:54:51	71.02	*	UpMax
01-19 15:54:49	71.04	*	UpMax
01-19 15:54:48	71.35	*	UpMax
01-19 15:54:43	41.91	*	None

select continuous or single transmission mode and set tolerance

single axis and dual axis automatic switching

real-time data (display in green when within tolerance and display in red when out of tolerance)

send data clear data

green background (within tolerance)
red background (out of tolerance)

DIGITAL LEVEL AND SLOPE METER

ABSOLUTE LEVEL

BACKLIGHT

BUZZER ALARM AT 0° AND 90°

WORKING TEMPERATURE -5°C~50°C

IP67 WATERPROOF



2175-360

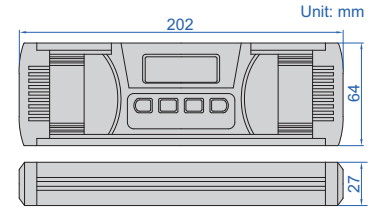

- IP67 dust/waterproof
- Used as level and slope meter
- Aluminum frame, shock absorbing rubber end caps
- Magnetic bottom with V-groove for shafts
- The sea level is permanently set inside the chip, zero setting is not needed when batteries are replaced
- Buttons: ON/OFF, backlight/buzzer alarm, absolute and incremental measurement, unit (mm/m, %, °), HOLD (keep the reading)
- Three AAA batteries, automatic power off

Code	Range	Resolution	Accuracy
2175-360	0-360° (90°×4)	0.05°; 1mm/m	at 0°: ±0.05°; at others: ±0.1°

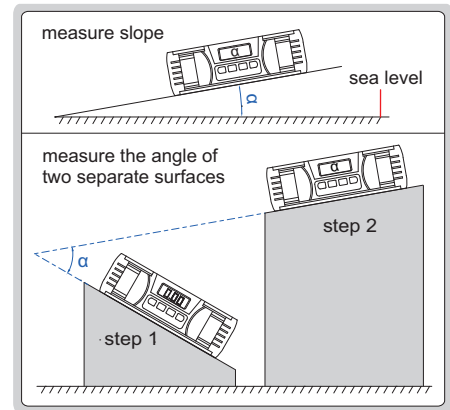

DIGITAL LEVEL AND SLOPE METER

ABSOLUTE LEVEL

BACKLIGHT

BUZZER ALARM AT 0° AND 90°

WORKING TEMPERATURE -5°C~50°C

IP54 WATERPROOF



2179-360

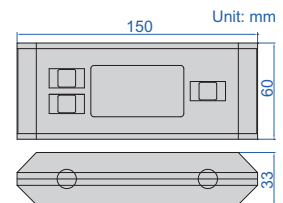

- IP54 dust/waterproof
- Used as level and slope meter
- Aluminum frame
- Magnetic bottom with V-groove for shafts
- The sea level is permanently set inside the chip, zero setting is not needed when battery is replaced
- Buttons: ON/OFF, absolute and incremental measurement, keep the reading, buzzer alarm, unit (mm/m, %, in/ft), conversion, backlight
- Two AAA batteries, automatic power off

Code	Range	Resolution	Accuracy
2179-360	0-360° (90°×4)	0.05°; 1mm/m; 0.125in/ft	at 0° and 90°: ±0.1°; at others: ±0.2°

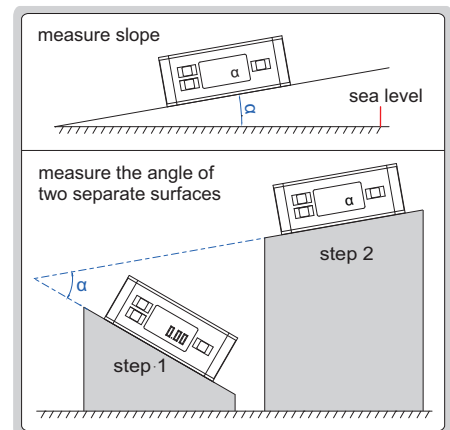

BACKLIGHT

MAGNETIC
BOTTOM

DISPLAY FLIPS OVER WHEN
THE BOTTOM FACES UP

WORKING TEMPERATURE
-5°C~50°C

ABSOLUTE
LEVEL



2198-2

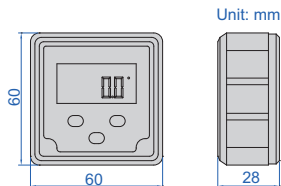

BLUETOOTH DIGITAL LEVEL AND SLOPE METER

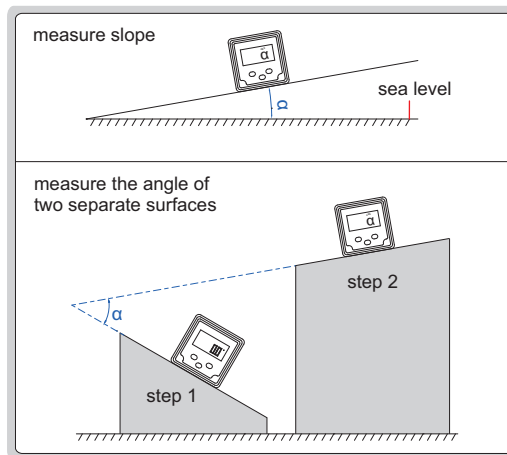

Android and iPhone APP (included), can choose real-time display (continuous transmission) or single transmission

- Used as level and slope meter
- Aluminum frame
- Magnetic bottom
- The display flips over when the bottom faces up
- The backlight is on automatically when in use, and automatically off in 15 seconds after use
- The sea level is permanently set inside the chip, zero setting is not needed when battery is replaced
- Buttons: ON/OFF, ZERO, HOLD, absolute and incremental measurement
- Built-in bluetooth, transmission distance is 15 meters (under the condition of no obstruction and no electromagnetic interference). Android and iPhone APP are included
- One AAA battery, automatic power off in 5 minutes

select continuous or single transmission mode and set tolerance

real-time data (display in green when within tolerance and display in red when out of tolerance)

send data

single transmission

clear data

graph

green background (within tolerance)

red background (out of tolerance)

time	mode	angle	alarm
03-15 16:53:21	ABS	-55.6	LowMax
03-15 16:53:19	ABS	-27.8	None
03-15 16:53:18	ABS	11.3	None
03-15 16:53:14	ABS	94.2	UpMax
03-15 16:53:13	ABS	50.6	UpMax
03-15 16:53:11	ABS	-91.9	LowMax
03-15 16:53:10	ABS	-85	LowMax

Code	Range	Resolution	Accuracy
2198-2	4x90°	0.1° (=1.745mm/m)	at 0° and 90°: ±0.1°; at others: ±0.2°

DIGITAL LEVEL AND SLOPE METER

MAGNETIC BOTTOM

WORKING TEMPERATURE
-5°C~50°C

BACKLIGHT

DISPLAY FLIPS OVER WHEN THE BOTTOM FACES UP

ABSOLUTE LEVEL

POPULAR MODEL



2170-1

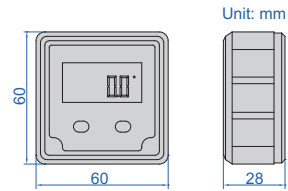

- Used as level and slope meter
- Aluminum frame
- Magnetic bottom
- The display flips over when the bottom faces up
- The backlight is on automatically when in use, and automatically off in 15 seconds after use
- The sea level is permanently set inside the chip, zero setting is not needed when battery is replaced
- Buttons: ON/OFF, ZERO, absolute and incremental measurement
- One AAA battery, automatic power off in 5 minutes

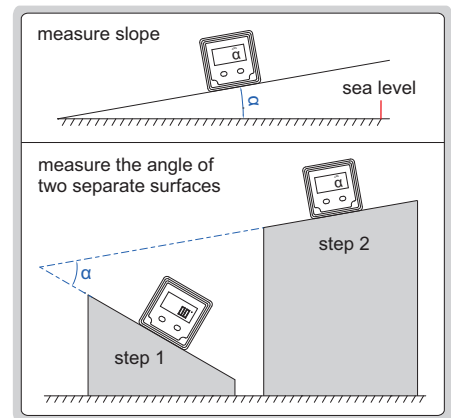

Code	Range	Resolution	Accuracy
2170-1	4x90°	0.1° (=1.745mm/m)	at 0° and 90°: ±0.1°; at others: ±0.2°

FRAME LEVELS



4902-200

- V-groove on bottom and left for shafts (shafts dia. 15~68mm)
- With transverse vial

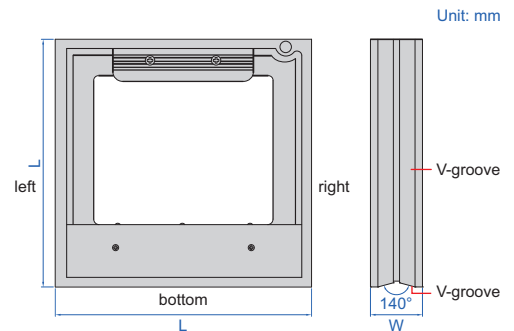

Code		Size (L×L)	W
Sensitivity 0.02mm/m (=0.001°)	Sensitivity 0.05mm/m (=0.0029°)		
4902-150	4902-C150	150x150mm	40mm
4902-200	4902-C200	200x200mm	40mm
4902-300	4902-C300	300x300mm	45mm

NO NEED TO SET ZERO BEFORE USE

FRAME LEVELS
INSIZE PLUS
 MADE IN EUROPE



4906-150

magnet on the left side



4906-150M

- No need to set zero before use
- Three V-grooves for shafts (shafts dia. 19.3~115.9mm)
- With longitudinal vial

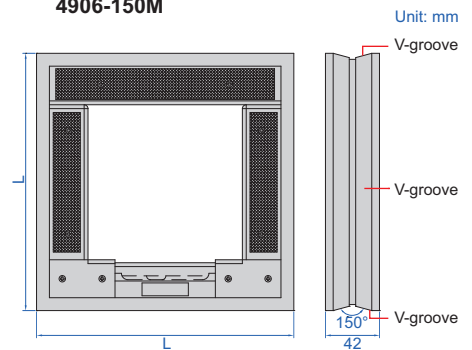

Code		Size (L×L)	Remark
Sensitivity 0.02mm/m (=0.001°)	Sensitivity 0.1mm/m (=0.0057°)		
4906-150	4906-B150	150×150mm	—
4906-200	4906-B200	200×200mm	—
4906-300	4906-B300	300×300mm	—
4906-150M	4906-B150M	150×150mm	with magnet
4906-200M	4906-B200M	200×200mm	with magnet
4906-300M	4906-B300M	300×300mm	with magnet



ELECTRONIC BLOCK LEVEL

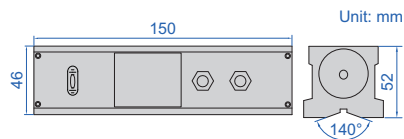

- Button function: power switch, zero, data save, ABS/REF
- 8 sets of measuring data can be saved on the LCD
- V-groove on bottom for shafts (shafts dia. 14~75mm)
- With transverse vial
- Li-ion battery power supply, for 30h continuous working
- Supplied with li-ion battery charger



4950-1

Code	Range	Resolution	Accuracy	Repeatability	Response time	Weight
4950-1	±5mm/m (±0.286°)	0.01mm/m (0.001°)	±(1+A×2%)Δ*	0.01mm/m	<3s	1.1kg

*A is the measured value, Δ is the resolution

BLOCK LEVELS

INSIZE PLUS
MADE IN EUROPE

- No need to set zero before use
- V-groove on bottom for shafts (shafts dia. 19.3~115.9mm)
- With longitudinal vial



4905-200

NO NEED TO SET ZERO BEFORE USE

Code		Size (L)
Sensitivity 0.02mm/m (=0.001°)	Sensitivity 0.1mm/m (=0.0057°)	
4905-160	4905-B160	160mm
4905-200	4905-B200	200mm
4905-300	4905-B300	300mm
4905-500	4905-B500	500mm

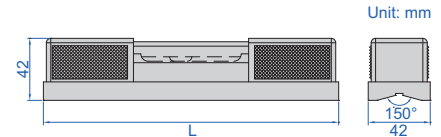

BLOCK LEVELS

- V-groove on bottom for shafts (shafts dia. 15~68mm)
- With transverse vial

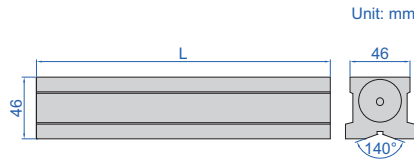

Code		Length (L)
Sensitivity 0.02mm/m (=0.001°)	Sensitivity 0.05mm/m (=0.0029°)	
4903-150A	4903-C150	150mm
4903-200A	4903-C200	200mm
4903-300A	4903-C300	300mm



4903-200A

POPULAR MODEL



SHORT LEVEL

INSIZE PLUS
MADE IN EUROPE

- No need to set zero before use
- Suitable for small spaces like crankshaft
- Longitudinal and transverse V-grooves on bottom for shafts (shafts dia. 19.3~115.9mm)
- With transverse vial



4907-90

NO NEED TO SET ZERO BEFORE USE

Code	Length	Sensitivity
4907-90	90mm	0.1mm/m (=0.0057°)

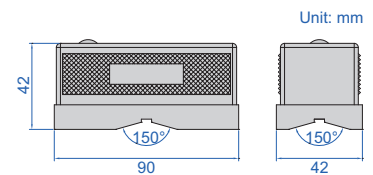

MINI LEVEL

INSIZE PLUS
MADE IN EUROPE

- No need to set zero before use
- With mounting holes (for M5 screws)



4908-100

NO NEED TO SET ZERO BEFORE USE

Code	Length	Sensitivity
4908-100	100mm	0.1mm/m (=0.0057°)

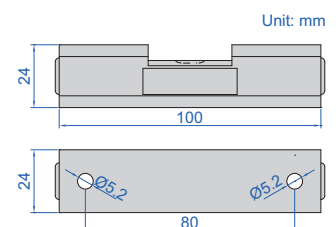



ABSOLUTE LEVEL

BACKLIGHT

WORKING TEMPERATURE
0°C~50°C

DIGITAL LEVELS AND SLOPE METERS

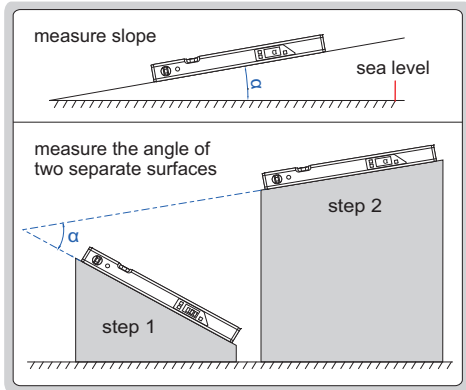

both angle and slope are displayed



4910-400



4910-600

- With transverse and longitudinal vials
- Used as level and slope meter
- Aluminum frame, magnetic bottom
- The sea level is permanently set inside the chip, zero setting is not needed when batteries are replaced
- Buttons: ON/OFF, absolute and incremental measurement, keep the reading, buzzer alarm (not for 4910-400), unit (mm/m, %, in/ft), conversion (not for 4910-400), backlight
- The display flips over when the bottom faces up
- Two AAA batteries
- Automatic power off

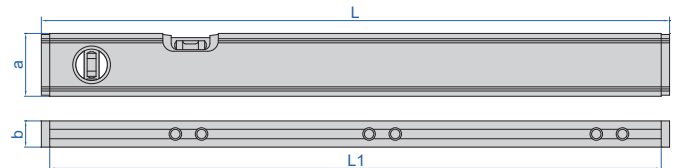

(mm)

Code	Range	Resolution	Accuracy	Remark*	L	L1	a	b
4910-400	0~360° (90°×4)	angle: 0.1°	±0.2°	both angle and slope are displayed (slope is calculated by angle)	416	400	50	21
4910-600	0~360° (90°×4)	at 0° and 90°: 0.05° ; at others: 0.1°	at 0° and 90°: ±0.1° ; at others: ±0.2°	at 0° and 90° buzzer alarm	600	585	60	25

*mm/m=tan(°)×1000, for example: 0.3°=tan (0.3)×1000=5mm/m

LIFETIME WARRANTY VIALS

MAGNETIC BASE

HANDY LEVEL

- Shockproof vials
- Magnetic base
- Shock absorbing rubber end caps
- Working temperature: -15°C~55°C



4912-100

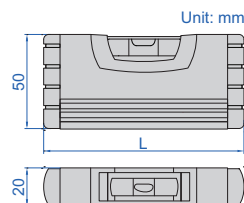

magnetic base surface



packaging

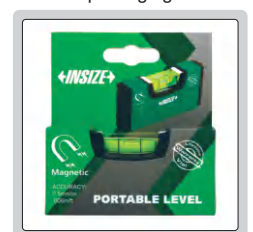

Code	Size (L)	Accuracy
4912-100	100mm	0.5mm/m

HANDY LEVELS

MAGNETIC BASE

LIFETIME WARRANTY VIALS



4922-100

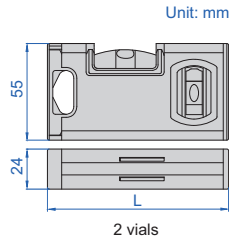

2 vials



4922-150

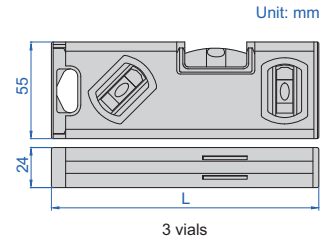

3 vials

Code	Size (L)	Accuracy	Number of vials
4922-100	100mm	0.5mm/m	2
4922-150	150mm	0.5mm/m	3
4922-200	200mm	0.5mm/m	3

- Shockproof horizontal and vertical vials
- Magnetic base
- Shock absorbing rubber end caps
- Working temperature: -15°C~55°C

CASTING ALUMINUM LEVEL

MAGNETIC BASE

LIFETIME WARRANTY VIALS

magnetic bottom surface (milled)

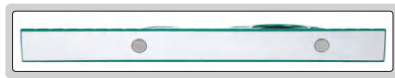

4913-250

packaging



- Shockproof horizontal and vertical vials
- Magnetic base
- Working temperature: -15°C~55°C
- Casting aluminum body

Code	Size (L)	Accuracy
4913-250	250mm	0.5mm/m

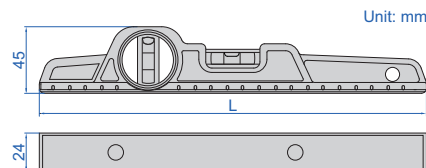

ALUMINUM LEVEL

MAGNETIC BASE

LIFETIME WARRANTY VIALS

- Shockproof horizontal and vertical vials
- Magnetic base
- Shock absorbing rubber end caps
- Working temperature: -15°C~55°C



4921-230

Code	Size (L)	Accuracy
4921-230	230mm	0.5mm/m

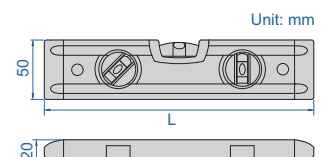

LIFETIME WARRANTY VIALS

MAGNETIC BASE

ALUMINUM LEVELS



4914-600

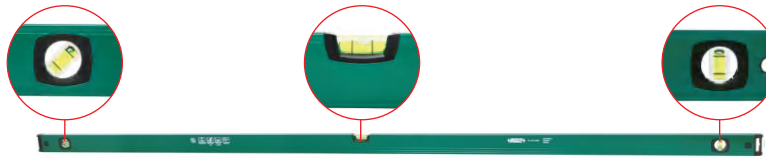

4914-2000

- Shockproof horizontal and vertical vials
- Magnetic base
- Shock absorbing rubber end caps
- Working temperature: -15°C~55°C

Code	Size (L)	Accuracy	Number of vials
4914-300	300mm	0.5mm/m	2
4914-600	600mm	0.5mm/m	2
4914-800	800mm	0.5mm/m	2
4914-1000	1000mm	0.5mm/m	2
4914-1200	1200mm	0.5mm/m	2
4914-2000	2000mm	0.5mm/m	3

Unit: mm

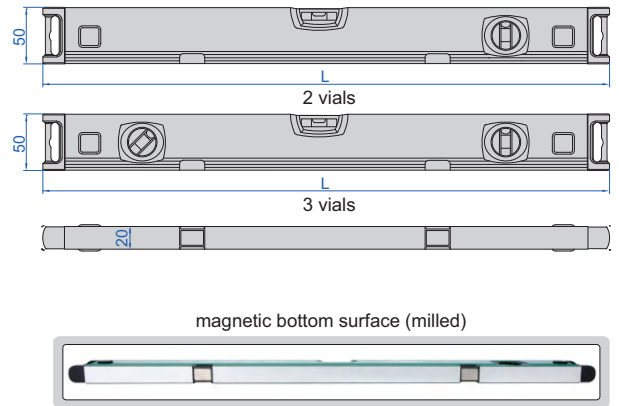

ALUMINUM LEVELS

LIFETIME WARRANTY VIALS

- Top and bottom working surfaces
- Shock-proof and UV-proof vials
- Die casting aluminum alloy frame
- Zero position of horizontal vial can be set
- One graduation of horizontal vial is 2% slope
- Working temperature: -15°C~55°C



4911-600

bottom surface (non-magnetic, milled)

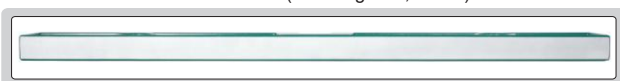

Code	Size (L)	Accuracy
4911-600	600mm	0.5mm/m
4911-800	800mm	0.5mm/m

Unit: mm

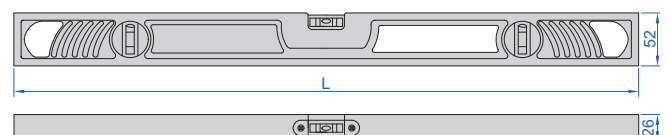

ALUMINUM LEVELS (BASIC TYPE)

MAGNETIC BASE

LIFETIME WARRANTY VIALS



4918-300

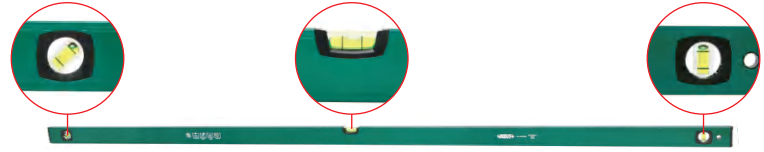

4918-2000

- Shock-proof and UV-proof vials
- Magnetic base
- Shock absorbing rubber end caps
- Working temperature: -15°C~55°C

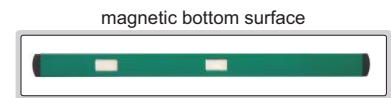

Code	Size (L)	Accuracy	Number of vials
4918-300	300mm	1mm/m	2
4918-600	600mm	1mm/m	2
4918-800	800mm	1mm/m	2
4918-1000	1000mm	1mm/m	2
4918-1200	1200mm	1mm/m	2
4918-2000	2000mm	1mm/m	3

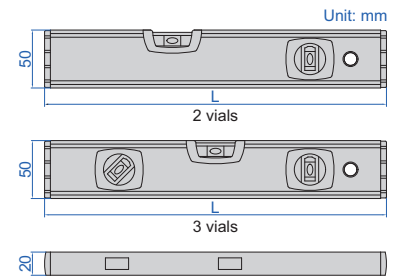

ALUMINUM LEVEL WITH RULER

LIFETIME WARRANTY VIALS



4923-600

- Shockproof horizontal and vertical vials
- Non-magnetic milled base
- Shock absorbing rubber end caps
- Range of ruler: 0-60cm, graduation: 1mm
- Working temperature: -15°C~55°C

Code	Size (L)	Accuracy
4923-600	600mm	0.5mm/m

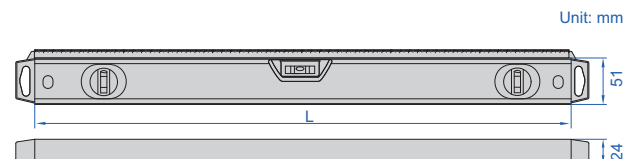



IP54
WATERPROOF

AUDIBLE AND VISUAL
ALARM WHEN OUT OF $\pm 3^\circ$

CROSS-LINE LASER LEVEL CODE 4917-30

- Red horizontal and vertical cross laser lines
- Self-leveling within $\pm 3^\circ$, self-leveling time within 4s, audible and visual alarm when out of $\pm 3^\circ$
- Folding legs for angle and height adjustment
- Outdoor use with the detector (code: 4917-DETECTOR)



application examples



folding legs for angle
and height adjustment

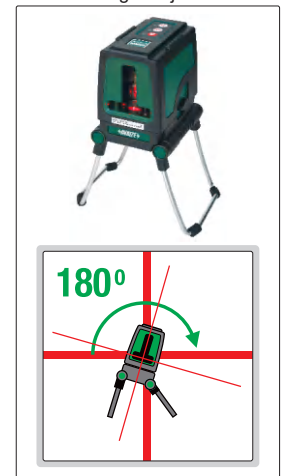

SPECIFICATION

Laser line width	2 \pm 0.5mm (within 5m)
Laser type	630~660nm, class II, <1mW
Beam angle	120 \pm 0.5 $^\circ$
Self-leveling range	$\pm 3^\circ$
Working distance	indoor: 30m, outdoor: 50m with detector (optional)
Accuracy	0.2mm/m
Operation temperature	-10~40 $^\circ$ C
Power supply	3 \times AA batteries, for 3 hours working
Dimension	100 \times 82 \times 104mm
Weight	620g

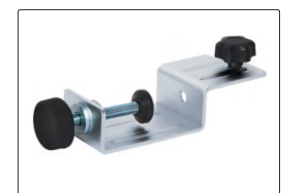

stand
(included with outdoor detector)

OUTDOOR DETECTOR (OPTIONAL)

Detecting distance	horizontal 1~50m, vertical 1~30m
Detecting accuracy *	high accuracy ± 1.5 mm, low accuracy ± 2.5 mm
Power supply	9V battery
Dimension	168 \times 58 \times 30mm
Weight	140g (battery included)

* Use high accuracy detection mode within 15m,
use low accuracy detection mode over 15m



outdoor detector (optional)

STANDARD DELIVERY

Main unit	1 pc
1/4" to 5/8" tripod adaptor	1 pc
Battery (AA)	3 pcs

OPTIONAL ACCESSORY

Outdoor detector	4917-DETECTOR
------------------	---------------

SELF-LEVELING ROTARY LASER CODE GRL-L340



INDICATOR FLASHING
WHEN OUT OF $\pm 5^\circ$

IP65
WATERPROOF



detector (included)



remote controller (included)



bracket for C battery (included)



beam finder glasses (included)



tripod (included)

- Applicable fields: construction, decoration, pipeline and equipment installation
- Green laser beam rotates 360° horizontally or vertically
- Self-leveling range $\pm 5^\circ$ on both X and Y planes
- Alarm when inclination is out of $\pm 5^\circ$
- $\pm 5^\circ$ leveling range for manual mode on both X and Y planes
- 5 variable speeds 0-600rpm
- 6 scan modes
- Plumb up and plumb down dots
- Remote control for long distance
- Power supply: AC or DC

application examples



horizontal leveling

vertical leveling

working with detector

SPECIFICATION

Working range	indoor 50m, outdoor 300m (with detector)	
Self leveling range	$\pm 5^\circ$	
Horizontal/vertical beam accuracy	$\pm 0.1\text{mm/m}$	
Main laser type	520~540nm, class 2, <1mW	
Auxiliary laser type	645~655nm, class 2, <1mW	
Rotating speed	0/60/120/300/600rpm	
Scanning range	0/10/45/90/180/360°	
Setting slope	X axis: $\pm 5^\circ$, Y axis: $\pm 5^\circ$	
Operation temperature	-20~50°C	
Maximum remote control distance	20m	
Power supply	remote controller	2×1.5V AAA batteries
	main unit	NI-MH batteries or 4×1.5V C batteries
	detector	1×9V battery
Dimension	210×210×213mm	
Weight	2.5kg	

STANDARD DELIVERY

Main unit (including NI-MH batteries)	1 pc
C battery and bracket	1 set
Detector	1 pc
Remote controller	1 pc
Beam finder glasses	1 pc
Laser target	1 pc
Power adapter	1 pc
AAA battery	2 pcs
9V battery	1 pc
Tripod	1 pc



Linear Probes
Page 555



Optical Grating Linear Gauges
And Display Units
Page 555-561



Capacitance Type Linear
Gauges And Display Units
Page 562-566



Laser Displacement Sensors
Page 567



Linear Scales And Digital Readouts
Page 568-572



Magnetic Linear Scales
Page 573-574



Scales
Page 575-576

INDUCTANCE TYPE PROBE CODE 9420-AP02

IP65
WATERPROOF



- Ultra-short length, built-in precision linear ball bearings
- For highly accurate and repeatable displacement measurements of displacement, deformation, dimension, vibration, thickness, expansion, etc. in quality control and metrology applications

SPECIFICATION

Range	±0.9mm
Resolution	0.1µm
Accuracy	±0.3+3× L ³µm, (L is measuring length in mm)
Repeatability	0.15µm
Thermal drift	0.25µm/°C
Mechanical stroke	2.2mm
Sensor type	LVDT
Measuring force	0.75N (measuring rod vertical down at 0±25% potential)
Protective cover	fluorinated elastomer
Contact type	carbide
Insert thread	M2.5
Sampling frequency	≥80ms
Operation environment	work: -10~60°C; storage: -20~100°C
Cable length	2m (customized from 2~5m)
Output interface	5-wire aviation interface
Weight	16g

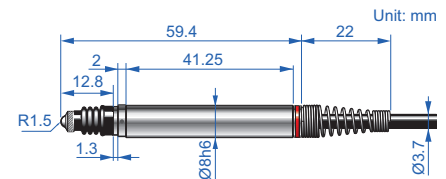

DIGITAL LINEAR GAUGES

**INSPECTION
CERTIFICATE**



ABSOLUTE ENCODER, THE ORIGINAL
DATA REMAINS AFTER POWER OFF

DUSTPROOF
WATERPROOF

- Scale type: optical grating
- Absolute encoder, the original data remains after power off
- Digital signal output, amplifier is not required
- Measuring force: ≤1.5N
- Dust/waterproof: IP43/IP66
- Baud rate: 9600 (can be customized)
- Cable length: 3m (can be customized)
- Optional accessory: software of linear gauge (code: **7130-SOFTWARE**, 8 probes can be connected at the same time, need to purchase the corresponding hubs)



7130-10



7130-10L

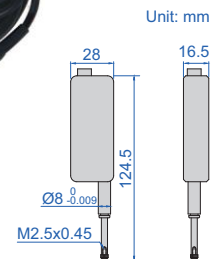

Dust/waterproof IP43, resolution 0.1µm

Code	Range	Repeatability	Accuracy	Outgoing cable direction	Output signal	Output interface
7130-10	0-12.5mm	0.5µm	1µm	horizontal	RS232, TTL level	
7130-10L	0-12.5mm	0.5µm	1µm	vertical	RS232, TTL level	
7130-11	0-12.5mm	0.5µm	1µm	horizontal	RS232, 232 level	
7130-11L	0-12.5mm	0.5µm	1µm	vertical	RS232, 232 level	
7130-12	0-12.5mm	0.5µm	1µm	horizontal	RS485 (VCC+5~12V)	
7130-12L	0-12.5mm	0.5µm	1µm	vertical	RS485 (VCC+5~12V)	
7130-13	0-12.5mm	0.5µm	1µm	horizontal	RS232, TTL level	
7130-13L	0-12.5mm	0.5µm	1µm	vertical	RS232, TTL level	
7130-14	0-12.5mm	0.5µm	1µm	horizontal	RS232, 232 level	
7130-14L	0-12.5mm	0.5µm	1µm	vertical	RS232, 232 level	

To be continued



Continued from previous page

Dust/waterproof IP43, resolution 0.5µm

Code	Range	Repeatability	Accuracy	Outgoing cable direction	Output signal	Output interface
7130-20	0-12.5mm	1.5µm	3µm	horizontal	RS232, TTL level	
7130-20L	0-12.5mm	1.5µm	3µm	vertical	RS232, TTL level	
7130-21	0-12.5mm	1.5µm	3µm	horizontal	RS232, 232 level	
7130-21L	0-12.5mm	1.5µm	3µm	vertical	RS232, 232 level	
7130-22	0-12.5mm	1.5µm	3µm	horizontal	RS485 (VCC+5~12V)	
7130-22L	0-12.5mm	1.5µm	3µm	vertical	RS485 (VCC+5~12V)	
7130-23	0-12.5mm	1.5µm	3µm	horizontal	RS232, TTL level	
7130-23L	0-12.5mm	1.5µm	3µm	vertical	RS232, TTL level	
7130-24	0-12.5mm	1.5µm	3µm	horizontal	RS232, 232 level	
7130-24L	0-12.5mm	1.5µm	3µm	vertical	RS232, 232 level	

Dust/waterproof IP66, resolution 0.1µm

Code	Range	Repeatability	Accuracy	Outgoing cable direction	Output signal	Output interface
7130-30	0-12.5mm	0.5µm	1µm	horizontal	RS232, TTL level	
7130-30L	0-12.5mm	0.5µm	1µm	vertical	RS232, TTL level	
7130-31	0-12.5mm	0.5µm	1µm	horizontal	RS232, 232 level	
7130-31L	0-12.5mm	0.5µm	1µm	vertical	RS232, 232 level	
7130-32	0-12.5mm	0.5µm	1µm	horizontal	RS485 (VCC+5~12V)	
7130-32L	0-12.5mm	0.5µm	1µm	vertical	RS485 (VCC+5~12V)	
7130-33	0-12.5mm	0.5µm	1µm	horizontal	RS232, TTL level	
7130-33L	0-12.5mm	0.5µm	1µm	vertical	RS232, TTL level	
7130-34	0-12.5mm	0.5µm	1µm	horizontal	RS232, 232 level	
7130-34L	0-12.5mm	0.5µm	1µm	vertical	RS232, 232 level	

Dust/waterproof IP66, resolution 0.5µm

Code	Range	Repeatability	Accuracy	Outgoing cable direction	Output signal	Output interface
7130-40	0-12.5mm	1.5µm	3µm	horizontal	RS232, TTL level	
7130-40L	0-12.5mm	1.5µm	3µm	vertical	RS232, TTL level	
7130-41	0-12.5mm	1.5µm	3µm	horizontal	RS232, 232 level	
7130-41L	0-12.5mm	1.5µm	3µm	vertical	RS232, 232 level	
7130-42	0-12.5mm	1.5µm	3µm	horizontal	RS485 (VCC+5~12V)	
7130-42L	0-12.5mm	1.5µm	3µm	vertical	RS485 (VCC+5~12V)	
7130-43	0-12.5mm	1.5µm	3µm	horizontal	RS232, TTL level	
7130-43L	0-12.5mm	1.5µm	3µm	vertical	RS232, TTL level	
7130-44	0-12.5mm	1.5µm	3µm	horizontal	RS232, 232 level	
7130-44L	0-12.5mm	1.5µm	3µm	vertical	RS232, 232 level	

software of linear gauge (optional)

The screenshot displays the INSIZE_SCADA software interface. At the top, there are several data fields for LVD1 through LVD8, with values like -8.8099, 10.9393, and 3.661. Below this is a 'real-time trend' section with a graph showing multiple data series over time. The graph has a y-axis labeled 'Data' ranging from -8 to 17 and an x-axis labeled 'Count' ranging from 0 to 205. A red line indicates a trend that is currently out of tolerance, while other lines are green. On the right side, there is a 'Port' control panel with 'DBSaveEn' and 'Serial' ports (Serial1 to Serial8) each with a status indicator (ON/OFF). At the bottom, there are buttons for 'NumCurvePot', 'InCurve', and 'Exit'.

view and export historical trend

view and export historical data

real-time data

real-time trend

data trend chart

the software can set tolerance and make real-time judgment (red when out of tolerance, green when within tolerance), set zero, data collection interval time, color, type and line width of trend lines, can view and export data to Excel report or BMP image

PNEUMATIC DIGITAL LINEAR GAUGES

DUSTPROOF
WATERPROOF

ABSOLUTE ENCODER, THE ORIGINAL
DATA REMAINS AFTER POWER OFF



7134-10L

- Scale type: optical grating
- Absolute encoder, the original data remains after power off
- Digital signal output, amplifier is not required
- Air pressure: 0.2-0.5MPa
- Measuring force: ≤1.5N
- Dust/waterproof: IP43/IP66
- Baud rate: 9600 (can be customized)
- Cable length: 3m (can be customized)
- Optional accessory: software of linear gauge (code: **7130-SOFTWARE**, 8 probes can be connected at the same time, need to purchase the corresponding hubs)

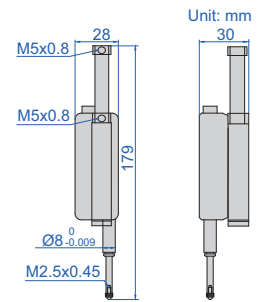

Dust/waterproof IP43, resolution 0.1µm

Code	Range	Repeatability	Accuracy	Outgoing cable direction	Output signal	Output interface
7134-10	0-12.5mm	0.5µm	1µm	horizontal	RS232, TTL level	
7134-10L	0-12.5mm	0.5µm	1µm	vertical	RS232, TTL level	
7134-11	0-12.5mm	0.5µm	1µm	horizontal	RS232, 232 level	
7134-11L	0-12.5mm	0.5µm	1µm	vertical	RS232, 232 level	
7134-12	0-12.5mm	0.5µm	1µm	horizontal	RS485 (VCC+5~12V)	
7134-12L	0-12.5mm	0.5µm	1µm	vertical	RS485 (VCC+5~12V)	
7134-13	0-12.5mm	0.5µm	1µm	horizontal	RS232, TTL level	
7134-13L	0-12.5mm	0.5µm	1µm	vertical	RS232, TTL level	
7134-14	0-12.5mm	0.5µm	1µm	horizontal	RS232, 232 level	
7134-14L	0-12.5mm	0.5µm	1µm	vertical	RS232, 232 level	

Dust/waterproof IP43, resolution 0.5µm



Code	Range	Repeatability	Accuracy	Outgoing cable direction	Output signal	Output interface
7134-20	0-12.5mm	1.5µm	3µm	horizontal	RS232, TTL level	
7134-20L	0-12.5mm	1.5µm	3µm	vertical	RS232, TTL level	
7134-21	0-12.5mm	1.5µm	3µm	horizontal	RS232, 232 level	
7134-21L	0-12.5mm	1.5µm	3µm	vertical	RS232, 232 level	
7134-22	0-12.5mm	1.5µm	3µm	horizontal	RS485 (VCC+5~12V)	
7134-22L	0-12.5mm	1.5µm	3µm	vertical	RS485 (VCC+5~12V)	
7134-23	0-12.5mm	1.5µm	3µm	horizontal	RS232, TTL level	
7134-23L	0-12.5mm	1.5µm	3µm	vertical	RS232, TTL level	
7134-24	0-12.5mm	1.5µm	3µm	horizontal	RS232, 232 level	
7134-24L	0-12.5mm	1.5µm	3µm	vertical	RS232, 232 level	

To be continued





Continued from previous page

Dust/waterproof IP66, resolution 0.1μm

Code	Range	Repeatability	Accuracy	Outgoing cable direction	Output signal	Output interface
7134-30	0-12.5mm	0.5μm	1μm	horizontal	RS232, TTL level	
7134-30L	0-12.5mm	0.5μm	1μm	vertical	RS232, TTL level	
7134-31	0-12.5mm	0.5μm	1μm	horizontal	RS232, 232 level	
7134-31L	0-12.5mm	0.5μm	1μm	vertical	RS232, 232 level	
7134-32	0-12.5mm	0.5μm	1μm	horizontal	RS485 (VCC+5~12V)	
7134-32L	0-12.5mm	0.5μm	1μm	vertical	RS485 (VCC+5~12V)	
7134-33	0-12.5mm	0.5μm	1μm	horizontal	RS232, TTL level	
7134-33L	0-12.5mm	0.5μm	1μm	vertical	RS232, TTL level	
7134-34	0-12.5mm	0.5μm	1μm	horizontal	RS232, 232 level	
7134-34L	0-12.5mm	0.5μm	1μm	vertical	RS232, 232 level	

Dust/waterproof IP66, resolution 0.5μm

Code	Range	Repeatability	Accuracy	Outgoing cable direction	Output signal	Output interface
7134-40	0-12.5mm	1.5μm	3μm	horizontal	RS232, TTL level	
7134-40L	0-12.5mm	1.5μm	3μm	vertical	RS232, TTL level	
7134-41	0-12.5mm	1.5μm	3μm	horizontal	RS232, 232 level	
7134-41L	0-12.5mm	1.5μm	3μm	vertical	RS232, 232 level	
7134-42	0-12.5mm	1.5μm	3μm	horizontal	RS485 (VCC+5~12V)	
7134-42L	0-12.5mm	1.5μm	3μm	vertical	RS485 (VCC+5~12V)	
7134-43	0-12.5mm	1.5μm	3μm	horizontal	RS232, TTL level	
7134-43L	0-12.5mm	1.5μm	3μm	vertical	RS232, TTL level	
7134-44	0-12.5mm	1.5μm	3μm	horizontal	RS232, 232 level	
7134-44L	0-12.5mm	1.5μm	3μm	vertical	RS232, 232 level	

software of linear gauge (optional)

view and export historical trend

view and export historical data

real-time data

real-time trend

data trend chart

the software can set tolerance and make real-time judgment (red when out of tolerance, green when within tolerance), set zero, data collection interval time, color, type and line width of trend lines, can view and export data to Excel report or BMP image

MULTICHANNEL INTERFACE BOXES OF LINEAR GAUGES



- Can be connected with 7130 or 7134 series linear gauges
- Optional accessory: software of linear gauge (code:7130-SOFTWARE, 8 linear gauges can be connected simultaneously)

7212-4A application

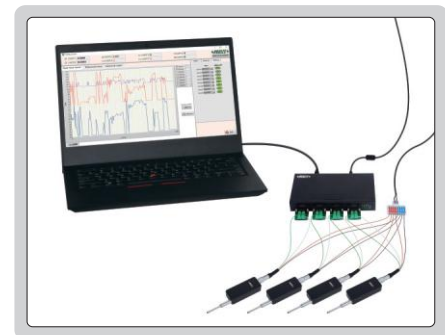

7324-HUB4 application

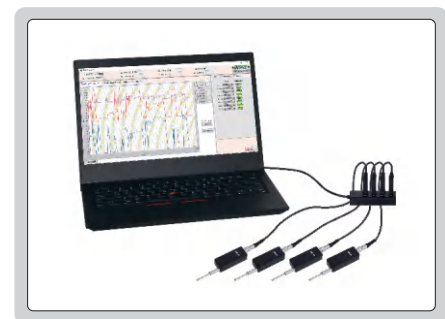

software of linear gauge (optional)

view and export historical trend

view and export historical data

real-time data

real-time trend

data trend chart

the software can set tolerance and make real-time judgment (red when out of tolerance, green when within tolerance), set zero, data collection interval time, color, type and line width of trend lines, can view and export data to Excel report or BMP image

SPECIFICATION

Code	7212-4A	7212-8A	7324-HUB4	7324-HUB7	7324-HUB16
Quantity of linear gauges	4	8	4	7	16
Applicable linear gauges	7130-12, 7130-12L, 7130-22, 7130-22L, 7130-32, 7130-32L, 7130-42, 7130-42L, 7134-12, 7134-12L, 7134-22, 7134-22L, 7134-32, 7134-32L, 7134-42, 7134-42L		7130-10, 7130-10L, 7130-20, 7130-20L, 7130-30, 7130-30L, 7130-40, 7130-40L, 7134-10, 7134-10L, 7134-20, 7134-20L, 7134-30, 7134-30L, 7134-40, 7134-40L		
Type of linear gauge	RS485 protocol		RS232 protocol		
Type of output	USB		USB		

IP67
WATERPROOF



LINEAR GAUGES



7138-121

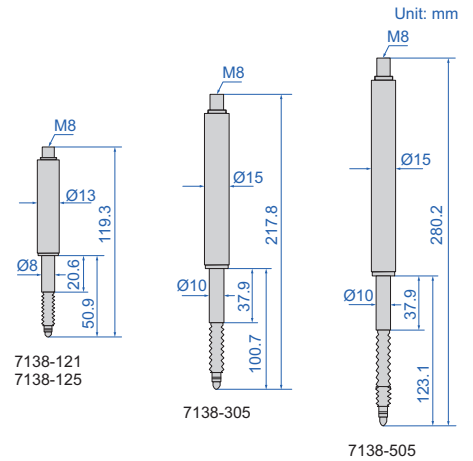

- Linear gauge type: optical grating
- Dust/waterproof: IP67
- Optional accessory: display unit (code **7131-1A**, can output keyboard signal, transmit data to excel, word, txt etc., also can output serial signal and transmit data to serial communication software)

L-connection cable
(optional)



straight connection cable
(optional)



application



SPECIFICATION

Code	7138-121	7138-125	7138-305	7138-505
Range	12mm	12mm	30mm	50mm
Resolution	0.1µm	0.5µm	0.5µm	0.5µm
Accuracy	±1µm	±2µm	±3µm	±3.5µm
Power supply	DC 5V, 300mA			
Output signal *	TTL signal			
Operation environment	0~40°C, 20~80%RH (non-condensing)			
Storage environment	-10~60°C, 20~80%RH (non-condensing)			
Dimension	Ø13×120mm		Ø15×218mm	Ø15×281mm
Weight	60g		130g	170g

* Output signal 485 or 232 is optional

OPTIONAL ACCESSORY

Display unit	7131-1A
L-connection cable	7138-L
Straight connection cable	7138-Z

LINEAR GAUGES AND DISPLAY UNIT



linear gauge
7131-01



display unit
7131-1A

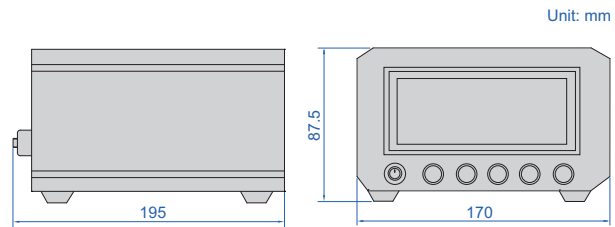
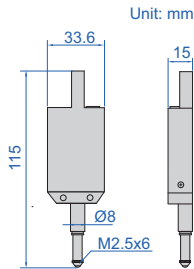
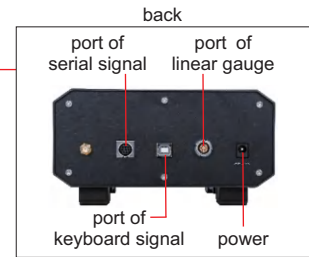

- Linear gauge type: optical grating
- Display unit: display displacement data in real time, data preset, set tolerance and make judgment (out of upper tolerance, within tolerance, out of lower tolerance), set zero, change measuring direction, resolution (0.1µm/1µm), unit switch (µm/mm/inch)
- Two data transmission methods: can output keyboard signal and data can be transmitted to excel, word, txt etc, can also output serial signal and transmit data to serial communication software

LINEAR GAUGE SPECIFICATION

Code	7131-01	7131-02
Range	12.5mm	12.5mm
Resolution	0.1µm	1µm
Accuracy (19~20°C)	1µm	3µm
Repeatability	0.2µm	2µm
Linear gauge type	optical grating	
Working life	ten million times	
Dust/waterproof	IP50	
Measuring force	0.7±0.3N	
Cable length	900mm	
Operation environment	0~40°C, 20~80%RH	
Power supply	5~24V	
Dimension (L×W×H)	33.6×15×115mm	
Weight	133g	

spindle lift knob is included



application



DISPLAY UNIT SPECIFICATION

Code	7131-1A
Display	4" LCD screen
Unit	µm, mm, inch
Quantity of linear gauge to be connected	1 pc
Dimension (L×W×H)	170×195×87.5mm
Weight	1.45kg

IP65
WATERPROOF

CAPACITANCE LINEAR GAUGES



7107-12

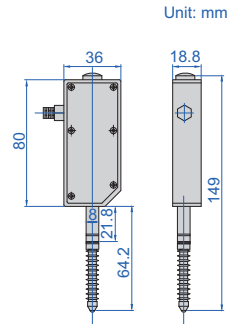

7107-11
7107-12



7107-12V

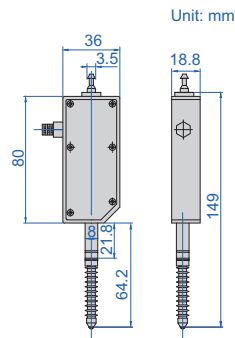

7107-11V
7107-12V

- Capacitance type linear encoder
- Shock-proof, water proof, dust proof, suitable for high speed movement, long working life
- Optional: display unit **7106-1A**, multichannel interface box **7107-1** or **7107-2**

SPECIFICATION

Code	7107-11	7107-12	7107-11V	7107-12V
Measuring range	12mm/0.47"	12mm/0.47"	12mm/0.47"	12mm/0.47"
Resolution	0.01mm/0.0004"	0.001mm/0.00004"	0.01mm/0.0004"	0.001mm/0.00004"
Accuracy	20μm	5μm	20μm	5μm
Hysteresis	10μm	2μm	10μm	2μm
Driving type	spring		pneumatic	
Measuring force	1.5N		adjusted by air pressure	
Measuring principle	capacitance type linear encoder			
Voltage	5V			
Sampling frequency	100 times/sec			
Working life	ten million times			
Dust/waterproof	IP65			
Cable length	2m			
Data output	RS232			

DISPLAY UNIT FOR CAPACITANCE LINEAR GAUGES CODE 7106-1A

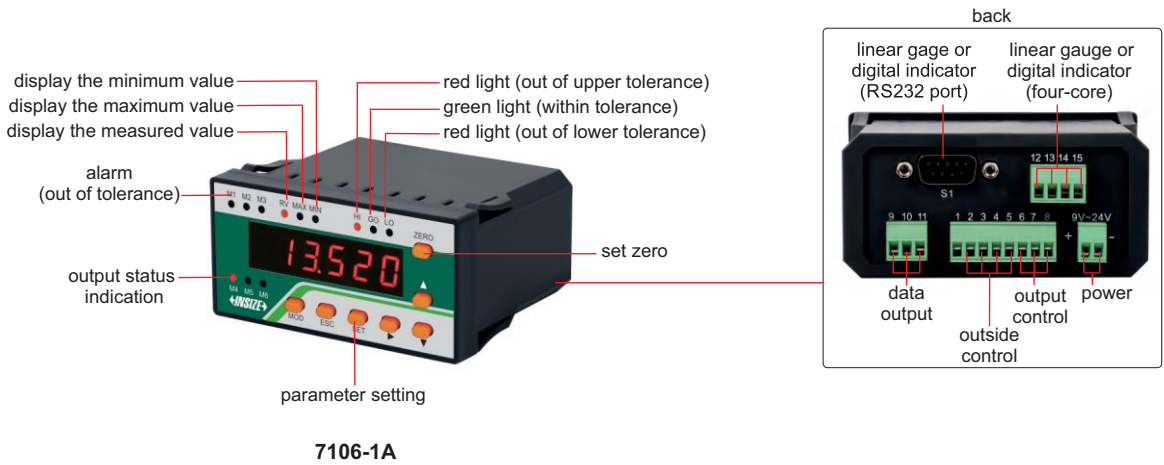

- Can be connected with **7107-11**, **7107-12**, **7107-11V** or **7107-12V** linear gauge, can also be connected with digital indicator (data cable **7309-C01M** is needed)
- Set tolerance and make judgment (out of upper tolerance, within tolerance, out of lower tolerance), output the judgment to control outside devices, control from outside (set zero, hold reading and collect data)
- Software of display unit (included): in the software, it is possible to set tolerance and show judgment (red when out of tolerance, green when within tolerance), set zero, collect data manually or automatically (time is adjustable), output data to Excel, print report

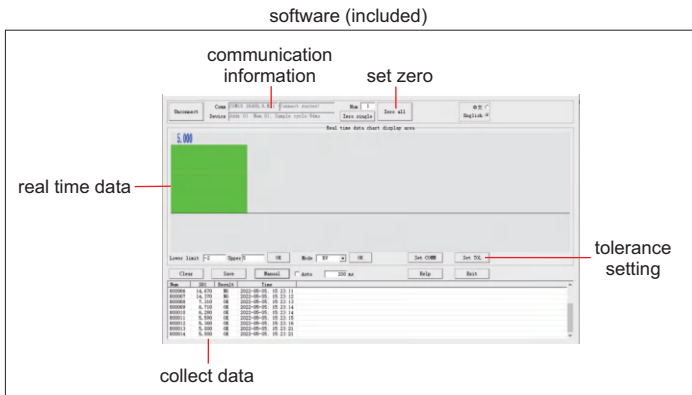
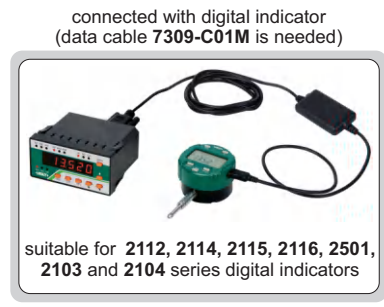
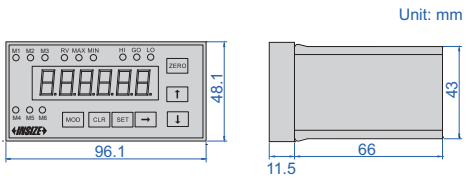

SPECIFICATION

Display	6 digits
Quantity of linear gauge or digital indicator to be connected	1 pc
Tolerance	set tolerance and make judgment with alarm and lights (out of upper tolerance, within tolerance, out of lower tolerance)
Output control	output the tolerance judgment (out of upper tolerance, within tolerance, out of lower tolerance) to control outside devices
Outside control	control the display units from outside (set zero, hold reading and collect data)
Data output	connect to computer software and serial communication
Power supply	DC 9~24V



MULTICHANNEL INTERFACE BOXES FOR CAPACITANCE LINEAR GAUGES

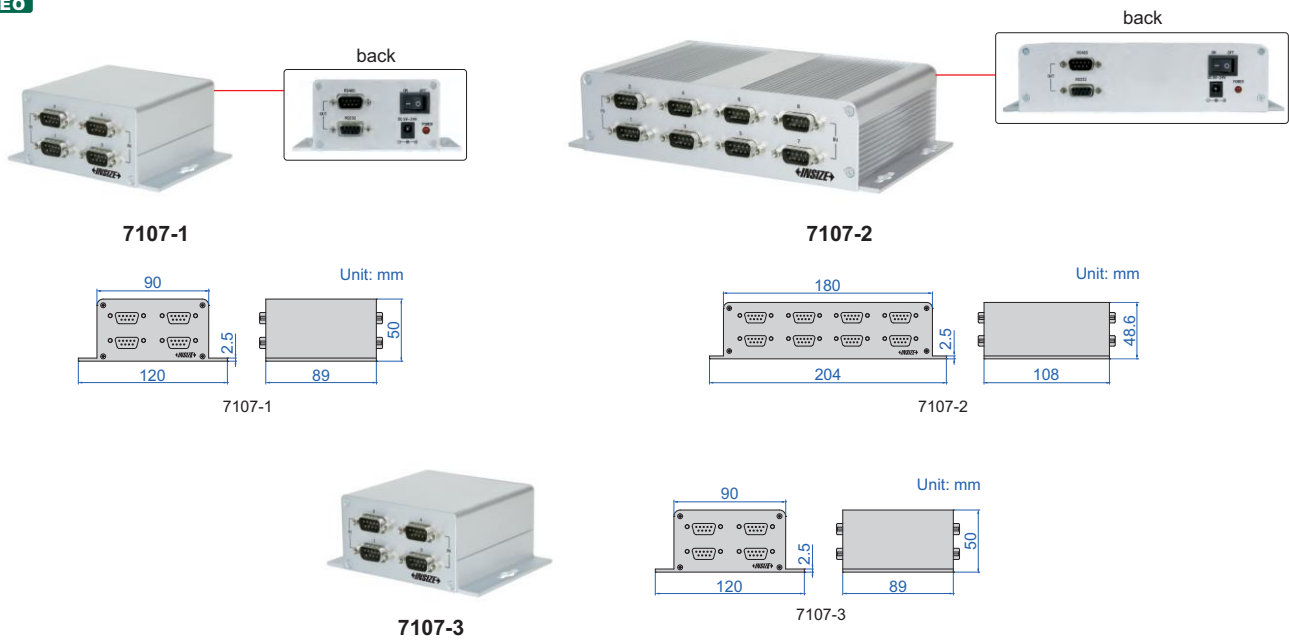

- Can be connected with **7107-11**, **7107-12**, **7107-11V** or **7107-12V** linear gauges, can also be connected with digital indicators (data cable **7309-C01M** is needed)
- Connection box (code: **7107-3**) is needed to connect interface boxes, when two or more interface boxes are used. Maximum 4 interface boxes can be connected.
- Software of interface boxes (included): in the software, it is possible to set tolerance of each channel and show judgment (red when out of tolerance, green when within tolerance), set zero, collect data manually or automatically (time is adjustable), output data to Excel, print report.

software (included)

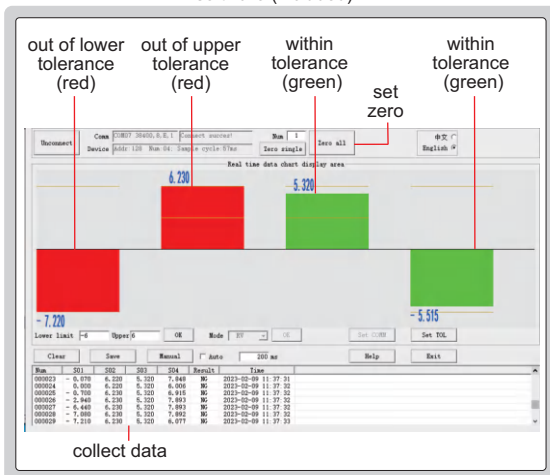

connected with **7107-11**, **7107-12**, **7107-11V** or **7107-12V** linear gauges

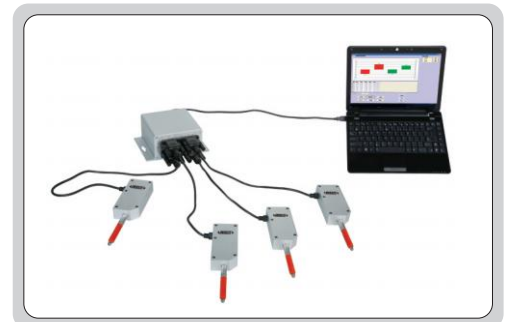

INTERFACE BOX SPECIFICATION

Code	7107-1	7107-2
Quantity of linear gauges or digital indicators to be connected	4 pcs	8 pcs
Data output	RS232 and RS485	
Power supply	DC 9~24V	

CONNECTION BOX (OPTIONAL) SPECIFICATION

Code	7107-3
Quantity of interface boxes to be connected	4 pcs (maximum 4 interface boxes can be connected)
Data output	RS232 and RS485
Power supply	DC 9~24V

connected with digital indicators (data cable **7309-C01M** is needed)



MULTICHANNEL DISPLAY UNITS



7133-1

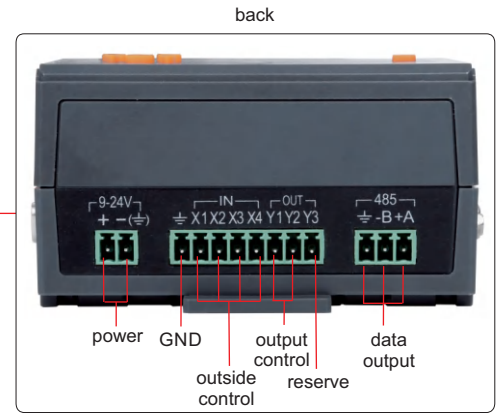

7133-2

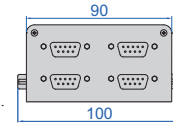

7133-1

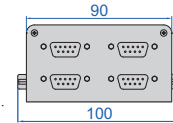
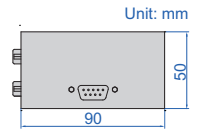

7133-2

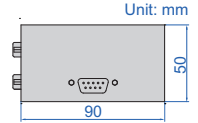

- Can be connected with 7107-11, 7107-12, 7107-11V or 7107-12V linear gauges, can also be connected with digital indicators (data cable 7309-C01M is needed)
- To connect more than 4 linear gauges or digital indicators, need to purchase the connection box (code: 7133-2), and one display unit can be connected with up to 14 connection boxes
- Set tolerance and make judgment (out of tolerance, within tolerance), output the judgment to control outside devices, control from outside (set zero, hold reading and collect data)
- Software of display unit (included): in the software, it is possible to set tolerance and show judgment (red when out of tolerance, green when within tolerance), set zero, collect data manually or automatically (time is adjustable), output data to Excel, print report

DISPLAY UNIT SPECIFICATION

Code	7133-1
Display	6 digits
Quantity of linear gauges or digital indicators to be connected	4 pcs
Tolerance	set tolerance and make judgment with lights (out of tolerance, within tolerance)
Output control	output the tolerance judgment (out of tolerance, within tolerance) to control outside devices
Outside control	control the display units from outside (set zero, hold reading and collect data)
Data output	connect to computer software and serial communication
Power supply	DC 9~24V

software (included)

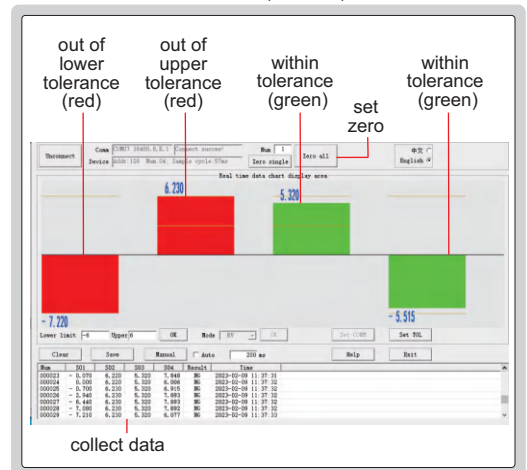





CONNECTION BOX (OPTIONAL) SPECIFICATION

Code	7133-2
Quantity of linear gauges or digital indicators to be connected	4 pcs





To be continued

Continued from previous page

use without computer
(measurement data of each channel can be switched to display on the display unit)

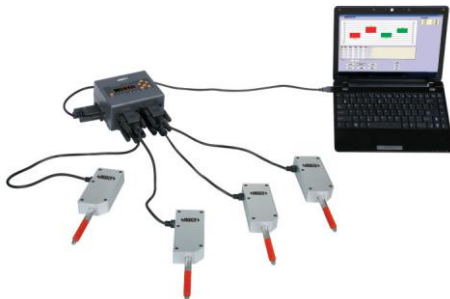
<p>display unit is connected with linear gauge (code 7107-11, 7107-12, 7107-11V or 7107-12V)</p> 	<p>display unit is connected with digital indicators (data cable 7309-C01M is needed)</p>  <p>suitable for 2112, 2114, 2115, 2116, 2501, 2103 and 2104 series digital indicators</p>
<p>display unit and connection box are connected with linear gauges (code 7107-11, 7107-12, 7107-11V or 7107-12V)</p> 	<p>display unit and connection box are connected with digital indicators (data cable 7309-C01M is needed)</p>  <p>suitable for 2112, 2114, 2115, 2116, 2501, 2103 and 2104 series digital indicators</p>

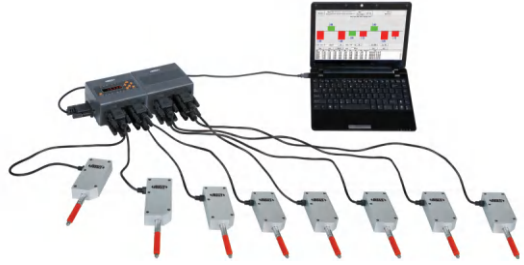
use with computer
(measurement data of all channel can be displayed in the software)

<p>display unit is connected with linear gauge (code 7107-11, 7107-12, 7107-11V or 7107-12V)</p> 	<p>display unit is connected with digital indicators (data cable 7309-C01M is needed)</p>  <p>suitable for 2112, 2114, 2115, 2116, 2501, 2103 and 2104 series digital indicators</p>
<p>display unit and connection box are connected with linear gauges (code 7107-11, 7107-12, 7107-11V or 7107-12V)</p> 	<p>display unit and connection box are connected with digital indicators (data cable 7309-C01M is needed)</p>  <p>suitable for 2112, 2114, 2115, 2116, 2501, 2103 and 2104 series digital indicators</p>

LASER DISPLACEMENT SENSORS

IP67
WATERPROOF

- High accuracy, non-contact measurement, high speed response, multiple measurement modes, environmental adaptability, programmable control, rich data output interface and easy maintenance
- Can be used in automated production lines, robotic arms, packaging equipment, printing equipment, medical equipment etc.



LDS-N30-RS

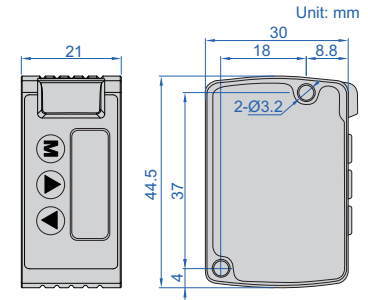

STANDARD DELIVERY

Main unit	1 pc
Mounting bracket	1 pc
Cable	1 pc

SPECIFICATION

Code	NPN	LDS-N30	LDS-N50	LDS-N100	LDS-N200	LDS-N400
	NPN+Analog	LDS-N30-MC	LDS-N50-MC	LDS-N100-MC	LDS-N200-MC	LDS-N400-MC
	NPN+RS485	LDS-N30-RS	LDS-N50-RS	LDS-N100-RS	LDS-N200-RS	LDS-N400-RS
Detection method	diffuse reflection					
Basis (center) distance	30mm	50mm	100mm	200mm	400mm	
Detection range (F.S.)	25~35mm	35~65mm	65~135mm	120~280mm	200~600mm	
Full scale	10mm	30mm	70mm	160mm	400mm	
Repeat accuracy	10µm	30µm	70µm	200µm	200~400mm: 600µm 400~600mm: 1500µm	
Linear accuracy	±0.2% F.S.				200~400mm: ±0.2% F.S. 200~400mm: ±0.3% F.S.	
Temperature drift characteristics	±0.03% F.S./°C					
Light source	medium	red diode laser, wavelength 655nm				
	output power	<1mW				
	laser class	IEC class 2				
Light spot diameter	Ø50µm	Ø70µm	Ø120µm	Ø300µm	Ø500µm	
Output	switch mode	NPN open collector, ≤50mA/DC 24V, residual voltage<1.5V				
	analog	analogue voltage: 0~5V (alarm: 5.2V), analogue current: 4~20mA (alarm: 0mA), Chinese display switchable				
	operation	Light.on/Dark.on selectable				
Response time	1.5ms/5ms/10ms, switchable					
Power supply	DC12~24V					
No-load current	<30mA (at supply voltage 24V DC), <60mA (at supply voltage 12V DC)					
Indicator light	output indicator: yellow, power indicator: green					
Protection circuit	reverse polarity protection/surge protection/short circuit protection					
Protection level	IP67					
Withstand voltage	AC1000V, 50/60Hz, 1min					
Vibration resistance	10~55Hz (period 1min), double amplitude 1.5mm, 2H in each X/Y/Z direction					
Impact resistance	500m/S ² (approx. 50G), 3 times each in X/Y/Z direction					
Insulation impedance	50MΩ or more (DC500V megohmmeter)					
Material	cover case	aluminium alloy				
	lens	PMMA				
	guidewire	PVC (polyvinyl chloride)				
Connection	switching: lead-in type (4-pole, standard cable length 2m), analogue: lead-in type (5-pole, standard cable length 2m)					
Ambient illumination	incandescent lamp ≤ 3000lux, sunlight ≤ 20000lux					
Ambient temperature	operation: -10~45°C, storage: -20~60°C(non-freezing)					
Ambient humidity	operation: 35~85%RH, storage: 35~85%RH (non-condensing)					
Weight	85g (include cable)					

IP54
WATERPROOF



ISL-A1-300

- Optical TTL (Through-The-Lens) detection.
These optical TTL linear scales use an transistor logic to transmit and record high-resolution distance measurements. They are the most accurate type of encoder and are paired with ISL-DR2/DR3 and ISL-LCD7 (digital readout)

Series ISL-A1 and ISL-A5

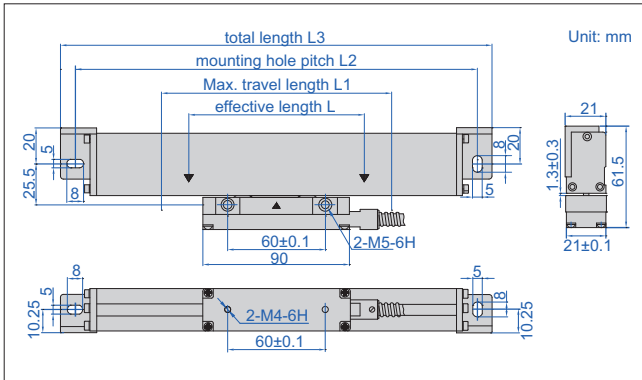

Series ISL-B5

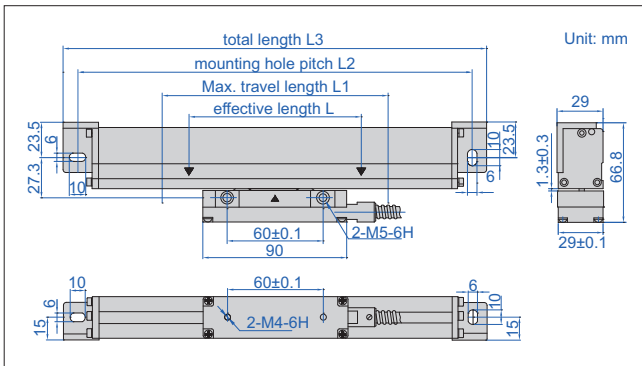

LINEAR SCALES (TTL SIGNAL)

Effective length (L)	Code		
	Thin type		Thick type
	Series ISL-A1	Series ISL-A5	Series ISL-B5
50mm	ISL-A1-50	ISL-A5-50	ISL-B5-50
100mm	ISL-A1-100	ISL-A5-100	ISL-B5-100
150mm	ISL-A1-150	ISL-A5-150	ISL-B5-150
200mm	ISL-A1-200	ISL-A5-200	ISL-B5-200
250mm	ISL-A1-250	ISL-A5-250	ISL-B5-250
300mm	ISL-A1-300	ISL-A5-300	ISL-B5-300
350mm	ISL-A1-350	ISL-A5-350	ISL-B5-350
400mm	ISL-A1-400	ISL-A5-400	ISL-B5-400
450mm	ISL-A1-450	ISL-A5-450	ISL-B5-450
500mm	ISL-A1-500	ISL-A5-500	ISL-B5-500
550mm	ISL-A1-550	ISL-A5-550	ISL-B5-550
600mm	ISL-A1-600	ISL-A5-600	ISL-B5-600
650mm	ISL-A1-650	ISL-A5-650	ISL-B5-650
700mm	ISL-A1-700	ISL-A5-700	ISL-B5-700
750mm	ISL-A1-750	ISL-A5-750	ISL-B5-750
800mm	ISL-A1-800	ISL-A5-800	ISL-B5-800
850mm	ISL-A1-850	ISL-A5-850	ISL-B5-850
900mm	ISL-A1-900	ISL-A5-900	ISL-B5-900
950mm	ISL-A1-950	ISL-A5-950	ISL-B5-950
1000mm	ISL-A1-1000	ISL-A5-1000	ISL-B5-1000
1100mm			ISL-B5-1100
1200mm			ISL-B5-1200
1300mm			ISL-B5-1300
1400mm			ISL-B5-1400
1500mm			ISL-B5-1500
1600mm			ISL-B5-1600
1700mm			ISL-B5-1700
1800mm			ISL-B5-1800
1900mm			ISL-B5-1900
2000mm			ISL-B5-2000
2100mm			ISL-B5-2100
2200mm			ISL-B5-2200
2300mm			ISL-B5-2300
2400mm			ISL-B5-2400
2500mm			ISL-B5-2500
2600mm			ISL-B5-2600
2700mm			ISL-B5-2700
2800mm			ISL-B5-2800
2900mm			ISL-B5-2900
3000mm			ISL-B5-3000
3100mm			ISL-B5-3100
3200mm			ISL-B5-3200

STANDARD DELIVERY

Main unit	1 pc
'L' shape support	1 pc
Anti-dust cover	1 pc
Plain base	1 pc (for L≥1500mm)
Mounting accessories	1 package

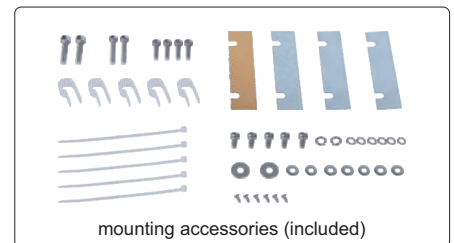
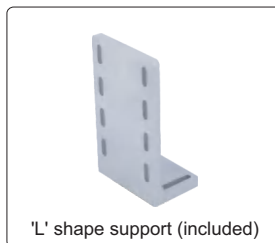

To be continued

Continued from previous page

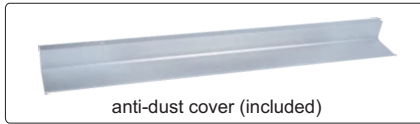

SPECIFICATION

Code	Series ISL-A1		Series ISL-A5		Series ISL-B5	
L1 (mm)	L+30 (L≤900)	L+50 (L>900)	L+30 (L≤900)	L+50 (L>900)	L+30 (L≤900)	L+50 (L>900)
L2 (mm)	L+132 (L≤900)	L+152 (L>900)	L+132 (L≤900)	L+152 (L>900)	L+136 (L≤900)	L+156 (L>900)
L3 (mm)	L+148 (L≤900)	L+168 (L>900)	L+148 (L≤900)	L+168 (L>900)	L+154 (L≤900)	L+174 (L>900)
Resolution	1µm		5µm		5µm	
Max. response speed	50m/min		90m/min		60m/min	
Scale grating pitch	20µm					
Scale reference point pitch	50mm					
Accuracy	±(5+5L/1000)µm L is the effective length in mm					
Cable length	3.5m (L: 50-950mm), 5m (L: 1000-1500mm), 10m (L: 1600-3200mm)					
Output signal	TTL					
Socket	9PD					
Power supply	5±0.5V					

LINEAR SCALES (RS422 SIGNAL)

IP54
WATERPROOF



ISL-C5-450

- Connected to digital display box or PLC

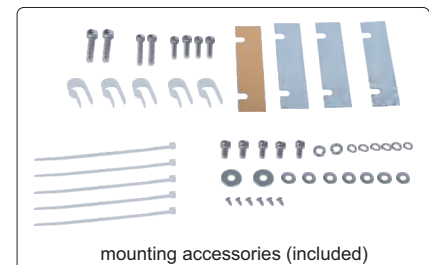
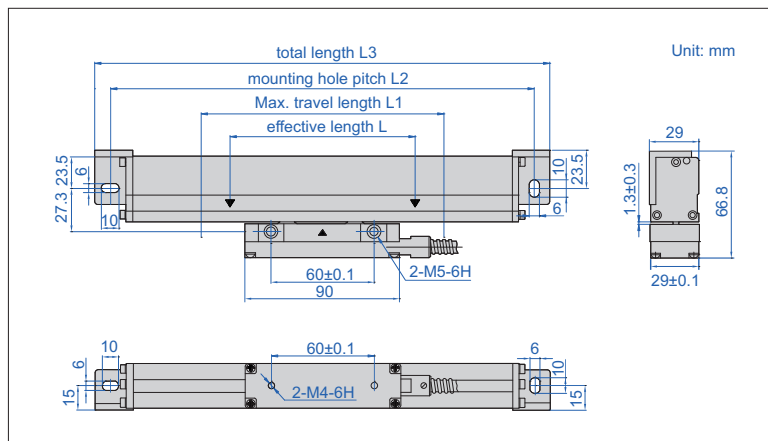
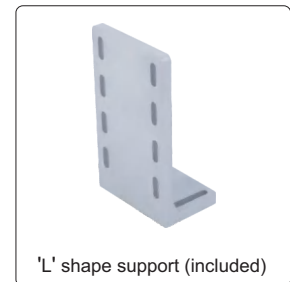

To be continued

Continued from previous page

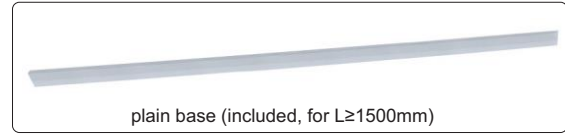
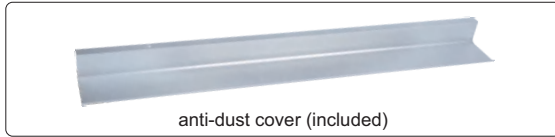

Effective length (L)	Code	
	Series ISL-C1	Series ISL-C5
50mm	ISL-C1-50	ISL-C5-50
100mm	ISL-C1-100	ISL-C5-100
150mm	ISL-C1-150	ISL-C5-150
200mm	ISL-C1-200	ISL-C5-200
250mm	ISL-C1-250	ISL-C5-250
300mm	ISL-C1-300	ISL-C5-300
350mm	ISL-C1-350	ISL-C5-350
400mm	ISL-C1-400	ISL-C5-400
450mm	ISL-C1-450	ISL-C5-450
500mm	ISL-C1-500	ISL-C5-500
550mm	ISL-C1-550	ISL-C5-550
600mm	ISL-C1-600	ISL-C5-600
650mm	ISL-C1-650	ISL-C5-650
700mm	ISL-C1-700	ISL-C5-700
750mm	ISL-C1-750	ISL-C5-750
800mm	ISL-C1-800	ISL-C5-800
850mm	ISL-C1-850	ISL-C5-850
900mm	ISL-C1-900	ISL-C5-900
950mm	ISL-C1-950	ISL-C5-950
1000mm	ISL-C1-1000	ISL-C5-1000

Effective length (L)	Code	
	Series ISL-C1	Series ISL-C5
1100mm	ISL-C1-1100	ISL-C5-1100
1200mm	ISL-C1-1200	ISL-C5-1200
1300mm	ISL-C1-1300	ISL-C5-1300
1400mm	ISL-C1-1400	ISL-C5-1400
1500mm	ISL-C1-1500	ISL-C5-1500
1600mm	ISL-C1-1600	ISL-C5-1600
1700mm	ISL-C1-1700	ISL-C5-1700
1800mm	ISL-C1-1800	ISL-C5-1800
1900mm	ISL-C1-1900	ISL-C5-1900
2000mm	ISL-C1-2000	ISL-C5-2000
2100mm	ISL-C1-2100	ISL-C5-2100
2200mm	ISL-C1-2200	ISL-C5-2200
2300mm	ISL-C1-2300	ISL-C5-2300
2400mm	ISL-C1-2400	ISL-C5-2400
2500mm	ISL-C1-2500	ISL-C5-2500
2600mm	ISL-C1-2600	ISL-C5-2600
2700mm	ISL-C1-2700	ISL-C5-2700
2800mm	ISL-C1-2800	ISL-C5-2800
2900mm	ISL-C1-2900	ISL-C5-2900
3000mm	ISL-C1-3000	ISL-C5-3000

SPECIFICATION

Code	Series ISL-C1	Series ISL-C5
L1 (mm)	L+30 (L≤900), L+50 (L>900)	L+30 (L≤900), L+50 (L>900)
L2 (mm)	L+136 (L≤900), L+156 (L>900)	L+136 (L≤900), L+156 (L>900)
L3 (mm)	L+154 (L≤900), L+174 (L>900)	L+154 (L≤900), L+174 (L>900)
Resolution	1µm	5µm
Thickness	29mm	
Max. response speed	60m/min	
Scale grating pitch	20µm	
Scale reference point pitch	50mm	
Accuracy	±(5+5L/1000)µm, L is the effective length in mm	
Cable length	3.5m (L: 50-950mm), 5m (L: 1000-1900mm), 10m (L: 2000-3000mm)	
Output signal	RS422	
Socket	9 PD	
Power supply	5±0.25V	

STANDARD DELIVERY

Main unit	1 pc
'L' shape support	1 pc
Anti-dust cover	1 pc
Plain base	1 pc (for L≥1500mm)
Mounting accessories	1 package

DIGITAL READOUTS

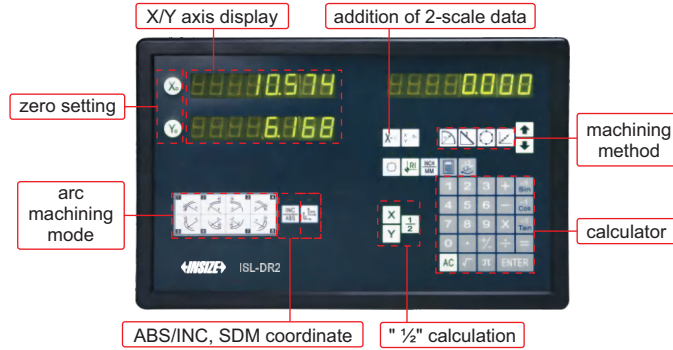

ISL-DR2

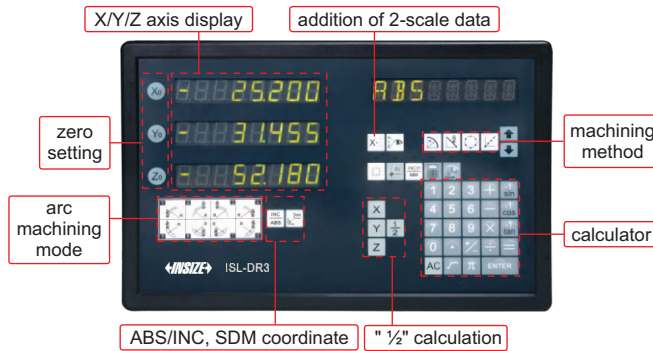

ISL-DR3



software flash disk (included)

■ For ISL-A1, ISL-A5, ISL-B5, ISL-C1, ISL-C5 series linear scales

SPECIFICATION

Code	ISL-DR2	ISL-DR3
Application	two-axis	three-axis
Scale input ports	2	3
Resolution	0.05μm, 0.1μm, 0.2μm, 0.5μm, 1μm, 2μm, 5μm, 10μm, 20μm, 50μm	
Functions	addition of 2-scale data, linearity error compensation, smoothing, RS232C interface unit, BCD code out, zero setting, preset, resolution setting, counting direction setting, inch/mm conversion, ABS/INC conversion, expansion/contraction coefficient setting, "1/2" calculation, detecting RI, bolt-hole circle machining, ramp circle machining	
Power supply	110/220V, 50/60Hz	
Dimension	295×185×45mm	
Weight	1.45kg	

STANDARD DELIVERY

Main unit	1 pc
Mounting bracket	1 pc
Ground cable	1 pc
RS232C cable	1 pc
Software flash disk for RS232C	1 pc

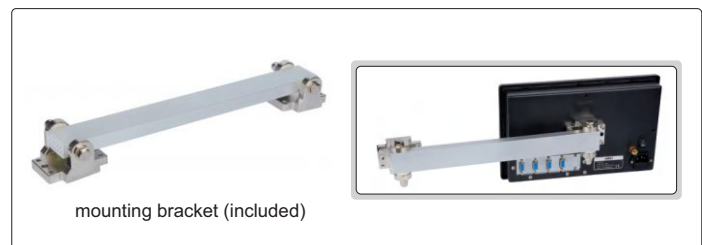



DIGITAL READOUT CODE ISL-LCD7



- 7.57 inch LCD display
- Language: English, Simplified Chinese, Traditional Chinese
- Can be connected with ISL-A1, ISL-A5, ISL-B5, ISL-C1, ISL-C5 series linear scales



SPECIFICATION

Application	three-axis: X/Y/Z
Scale input ports	3
Resolution	0.05μm, 0.1μm, 0.2μm, 0.5μm, 1μm, 2μm, 5μm, 10μm, 20μm, 50μm
Function	X/Y/Z addition of 3-scale data, linearity error compensation, smoothing, RS232C interface unit, BCD code out, zero setting, preset, resolution setting, counting direction setting, inch/mm conversion, ABS/INC conversion, expansion/contraction coefficient setting, "1/2" calculation, detecting RI, bolt-hole circle machining, ramp circle machining, circular arc machining, oblique surface machining, automatic edge finding, discharge machining
Dimension	200×88×260mm
Weight	1.26kg

STANDARD DELIVERY

Main unit	1 pc
Mounting bracket	1 pc
Ground cable	1 pc
RS232C cable	1 pc
Software flash disk for RS232C	1 pc

MAGNETIC LINEAR SCALES (ABSOLUTE TYPE)

IP65
WATERPROOF



reader
LSK-A12

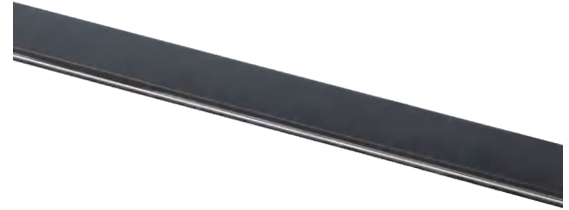

magnetic linear scale

- Absolute encoder, the original data remains after power off
- Support multiple communication protocols
- Cable length: 0.5m (can be customized up to 15m)
- Dust/waterproof: IP65

application



READER SPECIFICATION

Code	Resolution	Repeatability	Max. response speed	Power supply	Current	Output protocol*	Output interface
LSK-A10	0.1μm	±0.5μm	5m/s	5V±5%	<200mA	BISS-C	
LSK-A11	0.5μm	±1μm					
LSK-A12	1μm	±2μm					
LSK-A20	0.1μm	±0.5μm					
LSK-A21	0.5μm	±1μm					
LSK-A22	1μm	±2μm					
LSK-A30	0.1μm	±0.5μm					
LSK-A31	0.5μm	±1μm					
LSK-A32	1μm	±2μm					

*The communication protocol can be customized to SSI, Panasonic, Tamagawa and RS485

MAGNETIC LINEAR SCALE

Code	Length**	Code	Length**
LSK-E1	1m	LSK-E9	9m
LSK-E2	2m	LSK-E10	10m
LSK-E3	3m	LSK-E11	11m
LSK-E4	4m	LSK-E12	12m
LSK-E5	5m	LSK-E13	13m
LSK-E6	6m	LSK-E14	14m
LSK-E7	7m	LSK-E15	15m
LSK-E8	8m	LSK-E16	16m

** Customized length according to customer requirements

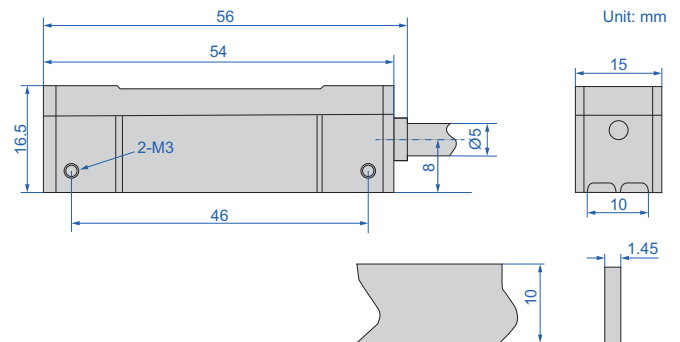

MAGNETIC LINEAR SCALE SPECIFICATION

Pitch	2+2mm
Accuracy	±40μm
Max. length	16.3m

OPTIONAL ACCESSORY

Code	Name	Description
LSK-B01	assistant tool	mounting magnetic linear scales



assistant tool (optional)



IP65
WATERPROOF

MAGNETIC LINEAR SCALES (INCREMENTAL TYPE)



reader
LSK-B12



magnetic linear scale

application

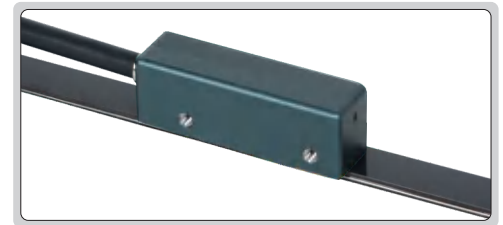

- Magnetic grating scale, incremental type
- Output frequency: 1000Hz (can be customized up to 8000Hz)
- Cable length: 0.5m (can be customized up to 15m)
- Dust/waterproof: IP65

READER SPECIFICATION

Code	Resolution	Repeatability	Max. response speed	Power supply	Current	Output protocol	Output interface
LSK-B10	0.1μm	±0.5μm	5m/s	5V±5%	<50mA	RS422	
LSK-B11	0.5μm	±1μm					
LSK-B12	1μm	±2μm					
LSK-B20	0.1μm	±0.5μm					
LSK-B21	0.5μm	±1μm					
LSK-B22	1μm	±2μm					
LSK-B30	0.1μm	±0.5μm					
LSK-B31	0.5μm	±1μm					
LSK-B32	1μm	±2μm					

MAGNETIC LINEAR SCALE

Code	Length*	Code	Length*	Code	Length*
LSK-C1	1m	LSK-C10	10m	LSK-C19	10m
LSK-C2	2m	LSK-C11	11m	LSK-C20	19m
LSK-C3	3m	LSK-C12	12m	LSK-C25	25m
LSK-C4	4m	LSK-C13	13m	LSK-C30	30m
LSK-C5	5m	LSK-C14	14m	LSK-C35	35m
LSK-C6	6m	LSK-C15	15m	LSK-C40	40m
LSK-C7	7m	LSK-C16	16m	LSK-C45	45m
LSK-C8	8m	LSK-C17	17m	LSK-C50	50m
LSK-C9	9m	LSK-C18	18m		

* Customized length according to customer requirements

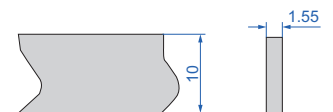
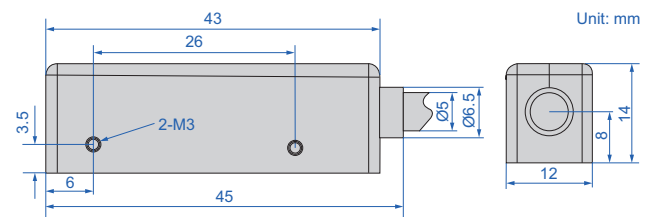

MAGNETIC LINEAR SCALE SPECIFICATION

Pitch	2+2mm
Accuracy	±40μm
Max. length	50m

OPTIONAL ACCESSORY

Code	Name	Description
LSK-B01	assistant tool	mounting magnetic linear scales



assistant tool (optional)

DIGITAL HORIZONTAL SCALES

DATA OUTPUT



7101-300A

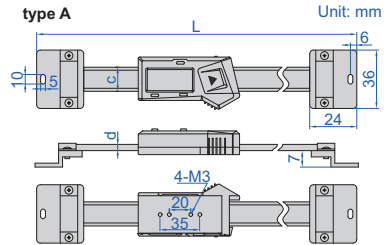

7101-400A

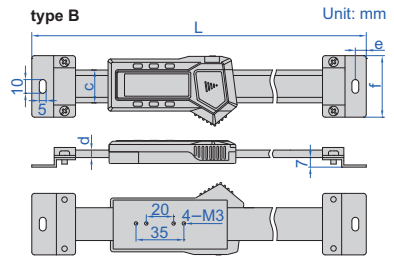

- Non waterproof
- Resolution: 0.01mm/0.0005"
- Buttons type A: on/off, zero, mm/inch, type B: on/off, zero, mm/inch, ABS, data preset
- Automatic power off, move the digital unit to turn on power
- Battery CR2032
- Data output
- Made of stainless steel
- Supplied with bracket to be mounted on the back

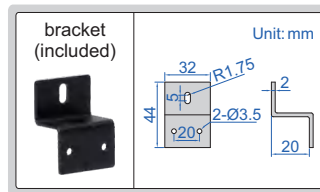

example of application

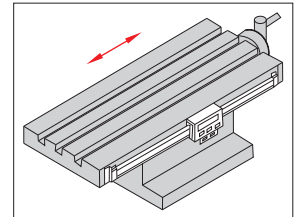

With data interface
(optional data output cable: code 7315-25 receiver is needed page 5, 7214-25 page 11, 7302-21 page 20, 7305-21 page 16)

Code	Range	Type	Accuracy	L	c	d
7101-100A	100mm	A	±0.02mm	215	16	4
7101-150A	150mm	A	±0.03mm	265	16	4
7101-200A	200mm	A	±0.03mm	315	16	4
7101-300A	300mm	A	±0.04mm	445	16	4

With data interface
(optional data output cable: code 7315-22 receiver is needed page 5, 7214-22 page 11, 7302-22 page 20, 7305-22 page 16)

Code	Range	Type	Accuracy	L	c	d	e	f
7101-400A	400mm	B	±0.05mm	590	24	5.5	8	45
7101-500A	500mm	B	±0.05mm	690	24	5.5	8	45
7101-600A	600mm	B	±0.08mm	790	24	5.5	8	45
7101-800A	800mm	B	±0.10mm	990	24	5.5	8	45
7101-1000A	1000mm	B	±0.10mm	1240	31	10.5	10	60

DATA
OUTPUT

DIGITAL VERTICAL SCALES



7102-300

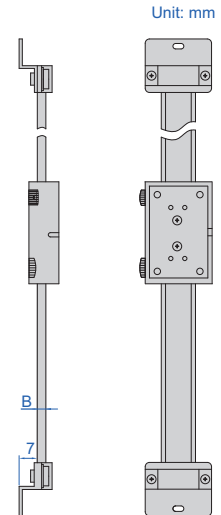
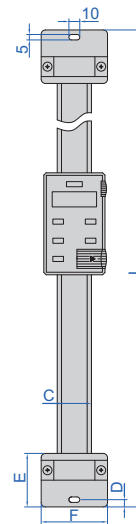

- Non waterproof
- Resolution: 0.01mm/0.0005"
- Buttons: on/off, zero, mm/inch, ABS/INC, data hold, TOL, set
- Battery LR44, data output
- Made of stainless steel
- Supplied with bracket to be mounted on the back
- Optional accessory:
 wireless transmitter code **7315-1150** (receiver is needed) page 7,
 data output cable (keyboard format) code **7302-SPC7** page 22,
 data output cable (serial port format) code **7305-1150** page 17

example of application

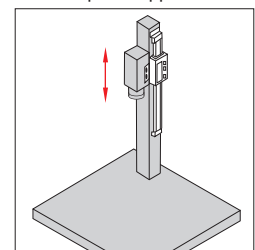

(mm)

Code	Range	Accuracy	B	C	D	E	F	L
7102-100	100mm/4"	±0.02mm	4	20	6	24	40	245
7102-150	150mm/6"	±0.03mm	4	20	6	24	40	296
7102-200	200mm/8"	±0.03mm	4	20	6	24	40	345
7102-300	300mm/12"	±0.04mm	4	20	6	24	40	445
7102-400	400mm/16"	±0.05mm	4	20	6	24	40	545
7102-500	500mm/20"	±0.05mm	5.5	24	8	32	45	685
7102-600	600mm/24"	±0.08mm	5.5	24	8	32	45	785
7102-800	800mm/32"	±0.10mm	5.5	24	8	32	45	985
7102-1000	1000mm/40"	±0.10mm	10.5	31	9.5	40	60	1245

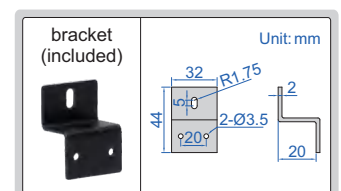



Roundness/Cylindricity Testers
Page 578-579



Roundness Measuring Machines
Page 580-581



Precision Air Floating Rotary Tables
Page 582



Surface Profile Measuring Machines
Page 583-591



Roughness Measuring Machines
Page 591-592



Roughness Testers
Page 593-603



Surface Roughness Specimens
Page 603-605



Surface Roughness Reference
Specimens
Page 605

ROUNDNESS/CYLINDRICITY TESTER CODE RCT-300

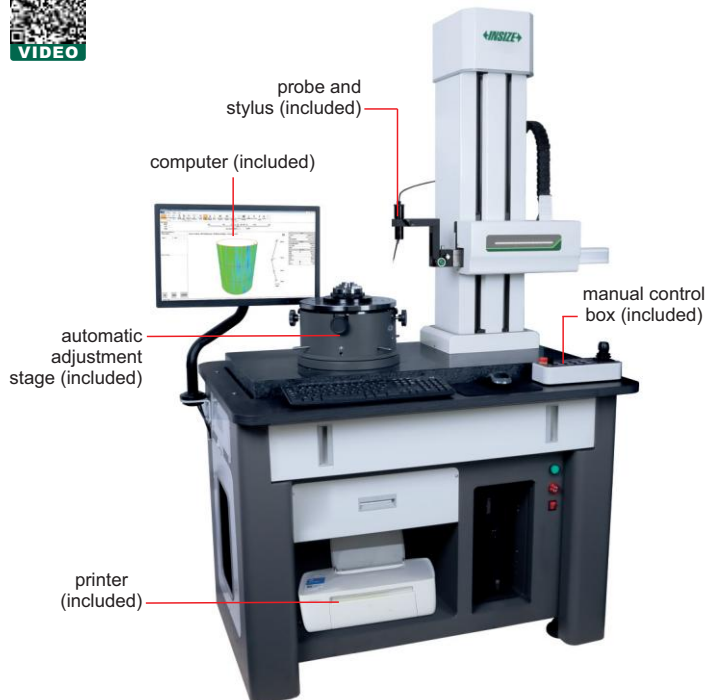

- Automatic centering and leveling
- Evaluation items
 - Cylindricity module: cylindricity, radial full run, coaxiality, taper, radius
 - Roundness module: roundness, concentricity, radial single jump, wall thickness difference
 - Straightness module: straightness, parallelism, squareness
 - Single section flatness module: single section flatness, axial single hop, perpendicularity, parallelism
 - Multi-section flatness module: multi-section flatness, parallelism, axial full runout, perpendicularity
 - Commutator module: monolithic bounce, immediate bounce, interval difference
- Analytical ability
 - Cylindricity function: 2-10 sections, 3 evaluation methods
 - Reference benchmarks for cylindricity evaluation: LSCY, MZCY, MICY, MCCY, OSCY
 - Reference circle for roundness evaluation: LSC, MZC, MIC, MCC
 - Measurement band: 1-15upr, 1-50upr, 1-150upr, 1-250upr, 1-500upr, 15-100upr, 15-500upr, 2-15upr, 1-1500upr, custom
 - Notched measurement

SPECIFICATION

Probe	measuring range	±500µm
	resolution	1:262144
	linear accuracy	0.1%
Ruby stylus	size	Ø2×10mm
	direction	two directions
	adjustable angle	±45°
X axis	travel	165mm
	excess range	25mm
	drive mode	motor
	moving speed	0.1~50mm/s
Z axis	measuring range	480mm
	straightness	0.3µm/100mm
	movement speed	0.1~10mm/s
	movement mode	motor
Detector	acquisition device	circular grating
	circumferential sampling points	14400
Granite stage		900×500mm
Rotary stage	rotation accuracy	(0.025+6H/10000)µm, H is the measuring height in mm
	rotation speed	6rpm, 8rpm, 10rpm
	max. measuring diameter	300mm
	max. workpiece diameter (rotation diameter)	450mm
Automatic adjustment stage	workbench diameter	280mm
	adjustment range of center	±3mm
	adjustment range of level	±1°
	weight capacity	30kg
Precision chuck	external grip diameter	Ø1~Ø81mm
	internal grip diameter	Ø31~Ø70mm
Air filter	pressure range	0~0.8MPa
	oil mist removal accuracy	0.01µm
	export oil mist concentration	0.5mg/m ³
Dimension (L×W×H)		1680×862×1685mm
Power supply		220±10%V, 50Hz
Power		500W
Weight		350kg

To be continued

Continued from previous page



air filter (included)



standard block (included)



column adjusting rod (included)



precision chuck (included)

STANDARD DELIVERY

Main unit	1 pc
Probe (with ruby stylus)	1 pc each
Standard block	1 pc
Column adjusting rod	1 set
Precision chuck	1 pc
Automatic adjustment stage	1 pc
Roundness cylindricity acquisition and analysis system	1 set
Air filter	1 set
Computer	1 pc
Printer	1 pc
Installation tools	1 set

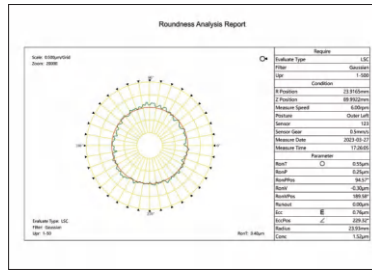

roundness analysis

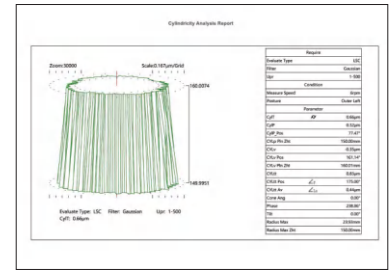

cylindricity analysis

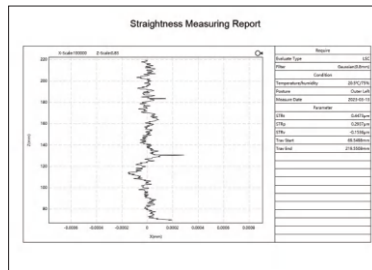

straightness analysis

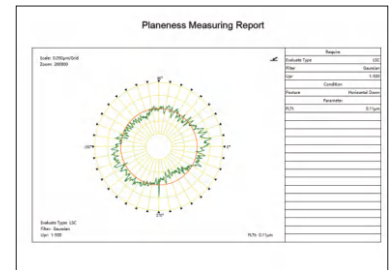

planeness analysis

OPTIONAL ACCESSORY

Probes	see below details
Precision chucks	see below details
Dryer	ISC-DRY

SPECIFICATION OF PROBES

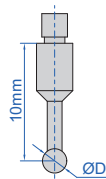

Code	Diameter (ØD)	Remark
RCT-RA260-T1	2mm	included
RCT-RA260-T2	0.5mm	optional
RCT-RA260-T3	1mm	optional
RCT-RA260-T4	4mm	optional
RCT-RA260-T5	8mm	optional

SPECIFICATION OF PRECISION CHUCKS

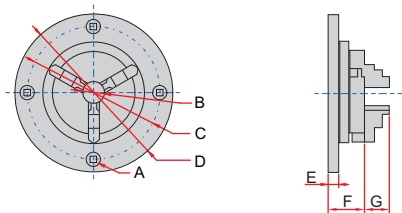

(mm)

Code	A	B	C	D	E	F	G	Clamping range		Remark
								external grip dia.	internal grip dia.	
RCT-RA260-C1	M5×0.8	16	100	118	8	28	13	Ø0.8~63	Ø23~58	optional
RCT-RA260-C2	M6×1.0	20	116	143	10.5	37	15	Ø1~81	Ø31~70	included
RCT-RA260-C3	M6×1.0	26	140	168	10	39	19	Ø1~100	Ø36~90	optional

ROUNDNESS MEASURING MACHINE CODE RCT-RA260



- Air-floating spindle
- Can measure roundness, coaxiality, concentricity, flatness, radial runout, axial runout, parallelism and perpendicularity
- Spectrum analysis, automatic gap/burr removal, waveform analysis
- 4 roundness evaluation methods: smallest area method, least square method, smallest circumscribed circle method, largest inscribed circle method
- Measuring filer: 1-15upr, 1-50upr, 1-150upr, 1-250upr, 1-500upr, 15-100upr, 15-500upr, 2-15upr
- Filter form: gauss (ISO standard)
- Software is included, for measurement, analysis, data output, etc.

SPECIFICATION

Probe	measuring range	±300μm
	resolution	0.001μm
	linear accuracy	0.25%
Ruby stylus	size	Ø2×10mm
	direction	two directions
	adjustable angle	±45°
X axis	travel	165mm
	excess range	25mm
	drive mode	by hand
Z axis	drive mode	motor
	travel	320mm
	movement speed	0.5~10mm/s
Rotary stage	rotation accuracy	(0.025+6H/10000)μm for H≤20mm, H is the measuring height in mm
	rotation speed	6rpm
	max. measuring diameter	260mm
	max. workpiece diameter (rotation diameter)	400mm
Rotary axis	radial rotation accuracy	±0.0125μm
	axial runout accuracy	±0.05μm
Adjustable 3D stage	diameter	180mm
	adjustment range of center	±3mm
	adjustment range of level	±2°
	weight capacity	20kg
Granite stage		700×500mm
Precision chuck	external grip diameter	Ø1~Ø81mm
	internal grip diameter	Ø31~Ø70mm
Air filter	pressure range	0~0.8MPa
	oil mist removal accuracy	0.01μm
	export oil mist concentration	0.5mg/m ³
Dimension (L×W×H)		1300×795×1715mm
Power supply		220±10%V, 50Hz
Power		500W
Weight		320kg

To be continued



PRECISION AIR FLOATING ROTARY TABLES



6875-320

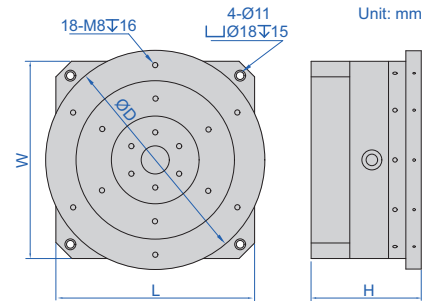

air filter (included)



- Manual rotation
- Optional accessory:
high precision digital indicators (code 2133 series),
hydraulic universal magnetic stands (code 6274 series)

Code	Stage size ØD	Max. RPM	Air supply pressure	Max. load	Radial stiffness	Axial stiffness	Radial runout	Axial runout	L×W×H
6875-320	320mm	500rpm	5-6bar	100kg	250N/μm	500N/μm	<0.3μm	<0.3μm	272×272×161mm
6875-400	400mm	500rpm	5-6bar	100kg	250N/μm	500N/μm	<0.3μm	<0.3μm	272×272×161mm
6875-500	500mm	500rpm	5-6bar	100kg	250N/μm	500N/μm	<0.3μm	<0.3μm	272×272×191mm

Standard glass hemisphere (optional)

Code	Roundness
6875-BALL*	0.05μm

*To check the accuracy of rotary table



6875-BALL



6875-CLAMP

Clamp for glass hemisphere (optional)

Code
6875-CLAMP

application



SURFACE PROFILE MEASURING MACHINE CODE SPM-1000



- Software is included, for surface profile measurement and data output
- Probe compensation
- Output as format txt, csv, etc.
- Large range design, the leverage ratio is 1:2.2, maintain the original accuracy of the sensor
- The overall structure of the Z-axis sensor does not have any elastic components, ensuring the measuring force is constant regardless the position of probe

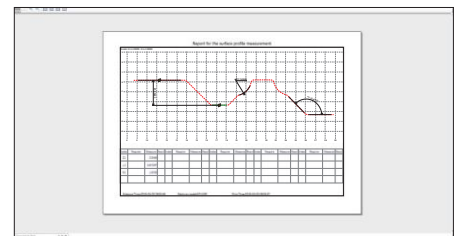
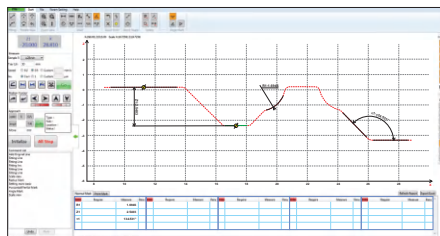
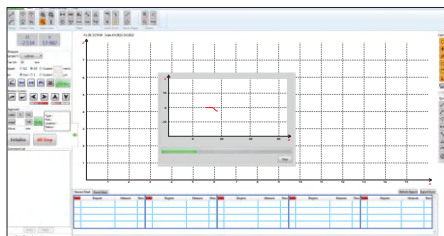
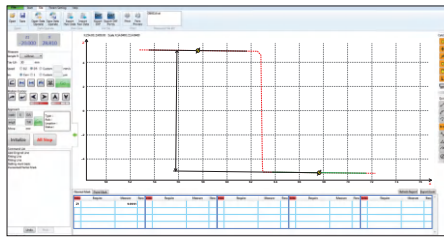

SPECIFICATION

X axis measuring range	140mm
X axis resolution	0.2 μ m
X axis straightness	0.8 μ m/100mm
X axis moving speed	0.1~10mm/s
Z axis measuring range	\pm 20mm
Z axis resolution	0.05 μ m
Z axis moving speed	0.5~10mm/s
Linear accuracy	$\pm(1.5+ 0.2H)\mu$ m, H is measuring height in mm
Angular measuring accuracy	$\pm 2'$
Arc measuring accuracy	$\pm(2+R/8)\mu$ m, R is 2~10mm standard ball
Radius of probe tip	25 μ m
Moving direction	backward
Measuring force	6.86~9.8mN
Measuring unit	mm/inch
Traceable angle	72° (upward), 87° (downward)
Drive mode	motor
Travel of Z axis	430mm
Dimension (L*W*H)	1200*700*1780mm
Power supply	220 \pm 5%V, 50Hz
Weight	320kg

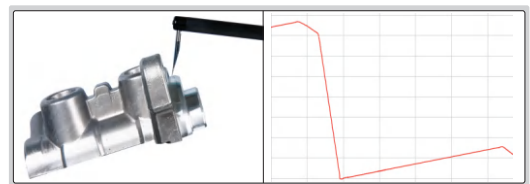

To be continued

Continued from previous page

STANDARD DELIVERY

Main unit	1 pc
Standard probe and arm	1 pc of each
Standard block	2 pcs
Standard ball	2 pcs
Standard shaft	1 pc
Stage	1 pc
Vise	1 pc
Measuring arm	1 pc
Computer	1 pc
Measurement software	1 pc
Printer	1 pc
Installation tools	1 set

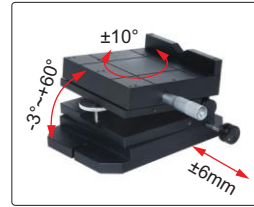

stage (included)

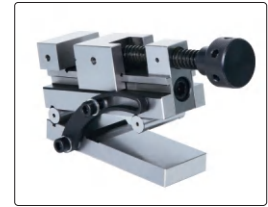

vise (included)

OPTIONAL ACCESSORY

Probe	refer to details
-------	------------------

SPECIFICATION OF PROFILE PROBES

Unit: mm

chisel stylus

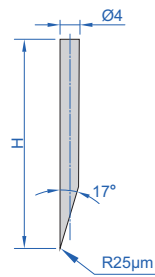

code **SPM-1000-T01** (H=32mm, included)
 code **SPM-1000-T02** (H=48mm, optional)
 code **SPM-1000-T03** (H=68mm, optional)

cone stylus

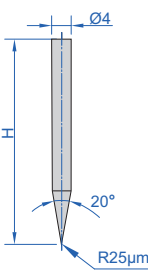

code **SPM-1000-Z01** (H=32mm, optional)
 code **SPM-1000-Z02** (H=48mm, optional)
 code **SPM-1000-Z03** (H=68mm, optional)

ball stylus

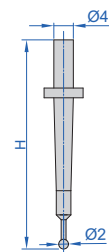

code **SPM-1000-R01** (H=32mm, optional)
 code **SPM-1000-R02** (H=48mm, optional)
 code **SPM-1000-R03** (H=68mm, optional)

standard arm, code SPM-1000-SP (included), stylus is not included

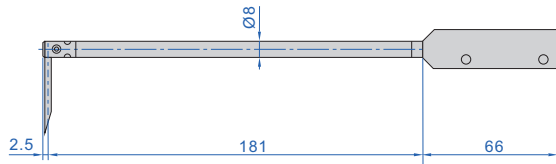

probe for small holes, code SPM-1000-SBP (optional), stylus is included

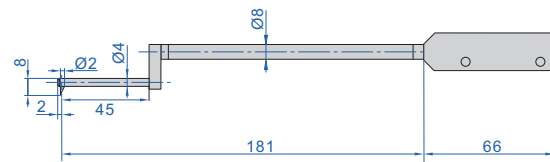

measure the contour of holes with diameter > Ø8mm

transverse probe, code SPM-1000-LP (optional), stylus is included

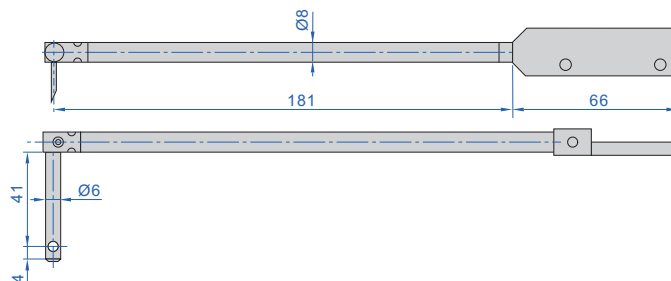

measure the contour of holes in radial direction

ROUGHNESS AND PROFILE MEASURING MACHINE (TWO PROBES TYPE) CODE SPM-2000

ATTENTION: PROFILE AND ROUGHNESS PROBES ARE USED SEPARATELY

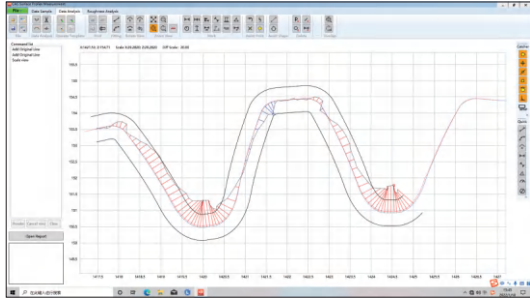

CAD profile comparison

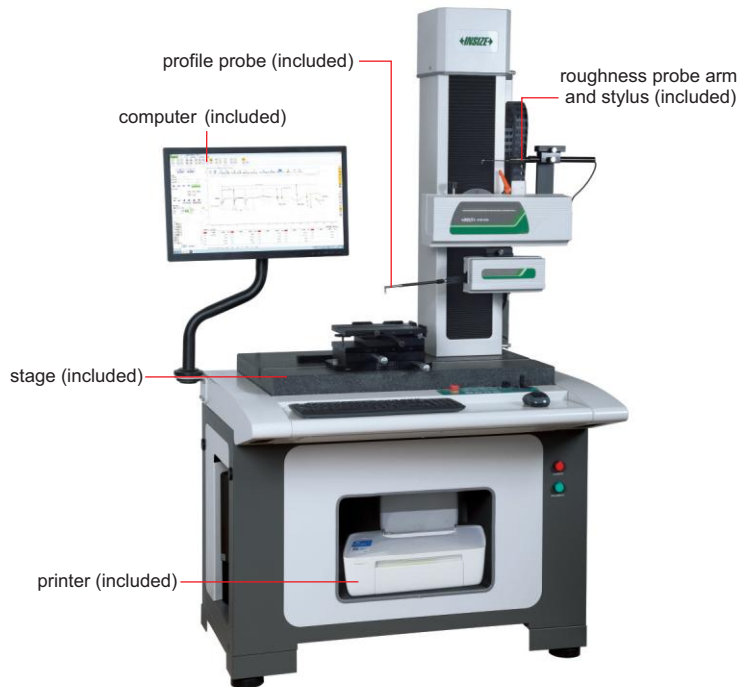

- Software is included, for measurement and data output
- Profile sensor with low noise
- Wide range roughness sensor without skid
- Meet ISO1997, ISO1984, BS1988, DIN1990, ASME1995, JIS1982, JIS1994 standards
- 65 roughness parameters

PROFILE MEASUREMENT SPECIFICATION

X axis measuring range	140mm
X axis resolution	0.2μm
X axis traverse speed	0.05~15mm/s
Z axis measuring range	50mm
Z axis resolution	0.05μm
Z axis traverse speed	0.2~15mm/s
Straightness	0.5μm/100mm
Linear accuracy	±(0.8+ 0.15H)μm, H is measuring height in mm
Angular measuring accuracy	±1'
Arc measuring accuracy	±(1.5+R/12)μm, R is 2~10mm standard ball
Measuring unit	μm/μin
Measuring speed	0.05~1mm/s
Traceable angle	72° (upward), 88° (downward)
Travel of Z axis	430mm
Power supply	220±5%V, 50Hz
Dimension (L×W×H)	1400×850×1780mm
Weight	350kg

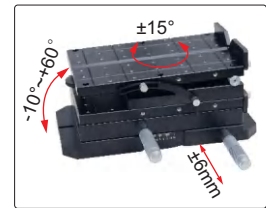

stage (included)



vise (included)



standard shaft (included)



standard blocks (included)



standard balls (included)

ROUGHNESS MEASUREMENT SPECIFICATION

Roughness parameters	Ra, Rp, Rv, Rz, Rz (JIS), R3z, Rz (DIN), Rzj, Rmax, Rc, Rt, Rq, Rsk, Rku, Rsm, Rs, PΔq, Rk, Rpk, Rvk, Mr1, Mr2, Rmr
Waviness parameters	Wa, Wt, Wp, Wv, Wz, Wq, Wsm, Wsk, Wku, Wmr
Primary profile parameters	Pa, Pt, Pp, Pv, Pz, Pq, Psm, Psk, Pku, Pmr
Measuring range	±420μm
Resolution	0.001μm
Linear accuracy	±(5nm+2.8%)
Probe radius/angle	5μm/90°
Cut off	0.025/0.08/0.25/0.8/2.5/8mm
Number of cut-offs	2~7
Measuring unit	μm
Measuring speed	0.05~0.25mm/s

To be continued

Continued from previous page

STANDARD DELIVERY

Main unit	1 pc
Calibration block	1 set
Roughness probe arm	1 pc
Roughness stylus	1 pc
Profile probe arm	1 pc
Profile chisel stylus	1 pc
Stage	1 set
Vise	1 set
Computer	1 pc
Software	1 set
Printer	1 pc
Installation tools	1 set

OPTIONAL ACCESSORY

Probe	refer to details
-------	------------------

SPECIFICATION OF ROUGHNESS PROBE

standard probe, code SPM-2000-P (included), stylus is included

small roughness probe, code SPM-2000-P1 (optional), stylus is included

SPECIFICATION OF PROFILE PROBES

Unit: mm

<p>chisel stylus</p> <p>code SPM-1000-T01 (H=32mm, included) code SPM-1000-T02 (H=48mm, optional) code SPM-1000-T03 (H=68mm, optional)</p>	<p>cone stylus</p> <p>code SPM-1000-Z01 (H=32mm, optional) code SPM-1000-Z02 (H=48mm, optional) code SPM-1000-Z03 (H=68mm, optional)</p>	<p>ball stylus</p> <p>code SPM-1000-R01 (H=32mm, optional) code SPM-1000-R02 (H=48mm, optional) code SPM-1000-R03 (H=68mm, optional)</p>
<p>standard arm, code SPM-1000-SP (included), stylus is not included</p>	<p>probe for small holes, code SPM-1000-SBP (optional), stylus is included</p> <p>measure the contour of holes with diameter >Ø8mm</p>	
<p>transverse probe, code SPM-1000-LP (optional), stylus is included</p> <p>measure the contour of holes in radial direction</p>		

ROUGHNESS AND PROFILE MEASURING MACHINE (ONE PROBE TYPE) CODE SPM-5000



PROFILE AND ROUGHNESS
MEASUREMENT AT THE SAME TIME

- Roughness, waviness, and profile analysis can be achieved with just one measurement
- Can measure all roughness and waviness parameters
- Can be used for automatic measurement system
- Air flotation and shockproof system to reduce measurement deviation
- Free to edit measurement reports

PROFILE MEASUREMENT SPECIFICATION

X axis measuring range	100mm
X axis resolution	0.2μm
X axis traverse speed	0.05~50mm/s
X axis linear accuracy	±(0.8+ 0.015L)μm, L is measuring length in mm
Z axis measuring range	±10mm
Z axis resolution	0.01μm
Z axis traverse speed	0.2~50mm/s
Z axis linear accuracy	±(0.5+ 0.08H)μm, H is measuring height in mm
Angular measuring accuracy	±1'
Arc measuring accuracy	±(1+R/12)μm, R is 2~10mm standard ball
Straightness	0.3μm/100mm
Measuring unit	mm/inch
Travel of Z axis	320mm
Power supply	220±5%V, 50Hz
Dimension (L×W×H)	1700×820×1900mm
Weight	500kg

ROUGHNESS MEASUREMENT SPECIFICATION

Roughness parameters	Ra, Ramax, Ramin, Rasd, Rp, Rpmax, Rpmin, Rpsd, Rv, Rvmax, Rvmin, Rvzd, Rz, Rzmax, Rzmin, Rzsd, R3z, Rc, Rcm, Rcm, Rcsd, Rt, Rq, Rqmax, Rqmin, Rdsd, Rsk, Rskmax, Rskmin, Rsksd, Rku, Rkumax, Rkumin, Rkusd, Rsm, Rsmmax, Rsmmin, Rsmsd, Rs, RΔa, RΔamax, RΔamin, RΔasd, RΔq, RΔqmax, RΔqmin, RΔqsd, Rk, Rpk, Rvk, Mr1, Mr2, RLa, Rlamax, Rlamin, Rlasd, Rlq, Rlqmax, Rlqmin, Rlqsd, Rδc, Rpc, Rmr
Waviness parameters	Wa, Wamax, Wamin, Wasd, Wsa, Wca, Wa08, Wc, Wcmax, Wcmin, Wcsd, Wt, Wz, Wzmax, Wzmin, Wzsd, Wp, Wpmax, Wv, Wvmax, Wvmin, Wvzd, Wq, Wqmax, Wqmin, Wqsd, Wsm, Wsmmax, Wsmmin, Wsmsd, Wsk, Wskmax, Wskmin, Wksd, Wku, Wkumax, Wkumin, Wkusd, WΔq, WΔqmax, WΔqmin, WΔqsd, Wδc, Wmr, Wpsd, Wpmin
Original profile parameters	Pa, Pt, Pp, Pc, Pv, Pz, Pq, Psm, Psk, Pku, RzJ, Rpq, Rvq, Rmq, Pmr, PΔq, Avh, Hmax, Hmin, Area, Pδc, Tilt
Motif parameters	Ncrx, R, Rx, AR, Nr, Cpm, Sr, Sar, W, Wx, Aw, Wte, Nw, Sw, Saw
Measuring range	±10mm
Resolution	0.01μm
Linear accuracy	±(4nm+2.5%)
Probe radius/angle	5μm/90°
Cut off	0.025/0.08/0.25/0.8/2.5/8mm
Number of cut-offs	2~7
Measuring unit	μm
Measuring speed	0.1~2mm/s

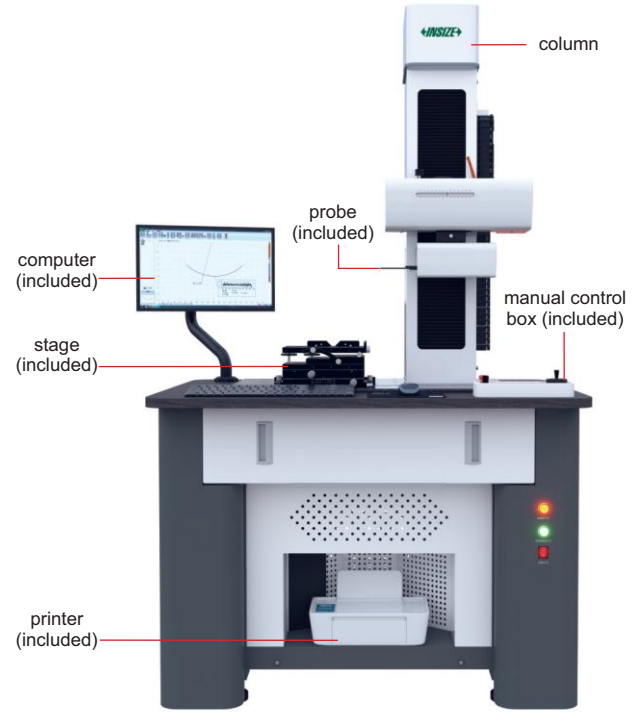

standard balls (included)



standard shaft (included)

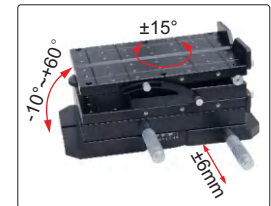

stage (included)



vise (included)



standard blocks (included)

To be continued

Continued from previous page

STANDARD DELIVERY

Main unit (including workbench, controller, driver, sensor)	1 pc
Calibration block	1 set
Probe arm	1 pc
Stylus	1 pc
Air flotation and shockproof system	1 set
Stage	1 set
Vise	1 set
Computer	1 pc
Software	1 set
Printer	1 pc
Installation tools	1 set

OPTIONAL ACCESSORY

Probe	refer to details
-------	------------------

SPECIFICATION OF STANDARD PROBE

Unit: mm

standard stylus , code SPM-5000-R1 (included)

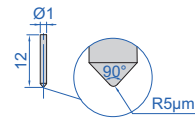

SPECIFICATION OF PROFILE PROBES

Unit: mm

chisel stylus

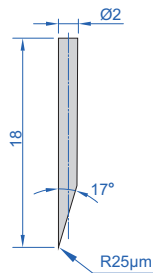

code **SPM-5000-T01** (optional)

standard arm, code SPM-5000-P1 (included), stylus is not included

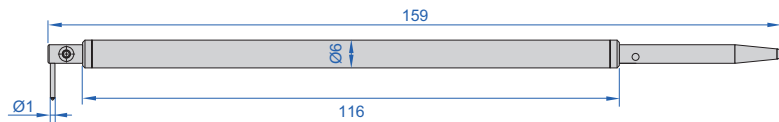

cone stylus

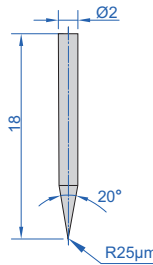

code **SPM-5000-Z01** (optional)

profile arm, code SPM-5000-P2 (optional), stylus is not included

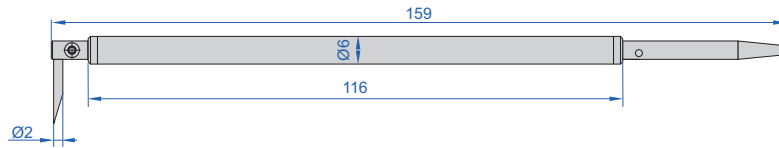

ball stylus

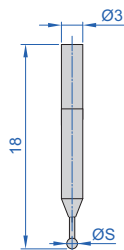

code **SPM-5000-S01** (ØS=1mm, optional)
code **SPM-5000-S02** (ØS=2mm, optional)

profile arm, code SPM-5000-P3 (optional), stylus is not included

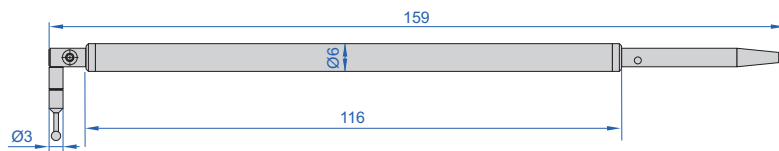

BIDIRECTIONAL ROUGHNESS AND PROFILE MEASURING MACHINE CODE SPM-6000



- Intelligent tracking control system, real-time scanning measurement
- Bidirectional probe measurement
- Constant measuring force
- Can be used to measure absolute diameters
- Real time variable speed measurement, high-speed measurement can also ensure accuracy
- The trajectory of the probe is vertical, with more realistic Z-axis coordinate point and large range
- The profile data point cloud spacing is consistent, enabling high accuracy measurement

PROFILE MEASUREMENT SPECIFICATION

X axis measuring range	325mm
X axis resolution	0.01 μ m
X axis traverse speed	5~10mm/s
X axis straightness	0.45 μ m/100mm
X axis linear accuracy	$\pm(0.8+L/100)\mu$ m, L is measuring length in mm
X axis measuring speed	0.2~0.7mm/s
Z axis measuring range	325mm
Z axis resolution	0.01 μ m
Z axis traverse speed	5~10mm/s
Z axis straightness	0.45 μ m/100mm
Z axis linear accuracy	$\pm(0.8+L/100)\mu$ m, H is measuring height in mm
Z axis measuring speed	0.2~0.7mm/s
Angular measuring accuracy	$\pm 2'$
Arc measuring accuracy	$\pm(0.8+R/15)\mu$ m
Measuring unit	mm/inch
Traceable angle	72° (upward), 89° (downward)
Power supply	220 \pm 5%V, 50Hz
Dimension (L*W*H)	1700*820*1900mm
Weight	500kg



ROUGHNESS MEASUREMENT SPECIFICATION

Roughness parameters	Ra, Ramax, Ramin, Rasd, Rp, Rpmax, Rpmin, Rpsd, Rv, Rvmax, Rvmin, Rvsd, Rz, Rzmax, Rzmin, Rzsd, R3z, Rc, Rcmx, Rcmn, Rcsd, Rt, Rq, Rqmax, Rqmin, Rd, Rsk, Rskmax, Rskmin, Rsksd, Rku, Rkumax, Rkumin, Rkugd, Rsm, Rsmmax, Rsmmin, Rmsd, Rs, R Δ a, R Δ amax, R Δ amin, R Δ asd, R Δ q, R Δ qmax, R Δ qmin, R Δ qsd, Rk, Rpk, Rvk, Mr1, Mr2, R λ a, R λ amax, R λ amin, R λ asd, R λ q, R λ qmax, R λ qmin, R λ qsd, R δ c, R ρ c, Rmr
Waviness parameters	Wa, Wamax, Wamin, Wasd, Wsa, Wca, Wa08, Wc, Wcmax, Wcmin, Wcsd, Wt, Wz, Wzmax, Wzmin, Wzsd, Wp, Wpmax, Wv, Wvmax, Wvmin, Wvsd, Wq, Wqmax, Wqmin, Wqsd, Wsm, Wsmmax, Wsmmin, Wmsd, Wsk, Wskmax, Wskmin, Wksd, Wku, Wkumax, Wkumin, Wkugd, W Δ q, W Δ qmax, W Δ qmin, W Δ qsd, W δ c, Wmr, Wpsd, Wpmin
Original profile parameters	Pa, Pt, Pp, Pc, Pv, Pz, Pq, Psm, Psk, Pku, RzJ, Rpq, Rvq, Rmq, Pmr, P Δ q, Avh, Hmax, Hmin, Area, P δ c, Tilt α
Motif parameters	Ncrx, R, Rx, AR, Nr, Cpm, Sr, Sar, W, Wx, Aw, Wte, Nw, Sw, Saw
Resolution	0.01 μ m
Linear accuracy	$\leq \pm(20nm+5\%)$
Probe radius/angle	5 μ m/90°
Cut off	0.025/0.08/0.25/0.8/2.5/8mm
Number of cut-offs	2~7
Measuring unit	μ m
Measuring speed	0.1~2mm/s

To be continued

Continued from previous page

STANDARD DELIVERY

Main unit (including workbench, controller, driver, sensor)	1 set
Calibration block	1 set
Profile arm	1 pc
Bidirectional profile stylus	1 pc
Roughness arm	1 pc
Unidirectional roughness stylus	1 pc
Stage	1 pc
Vise	1 pc
Computer	1 pc
Software	1 set
Printer	1 pc
Installation tools	1 set



calibration blocks (included)

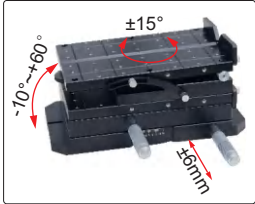

stage (included)



vise (included)



standard shaft (included)

APPLICATION EXAMPLES

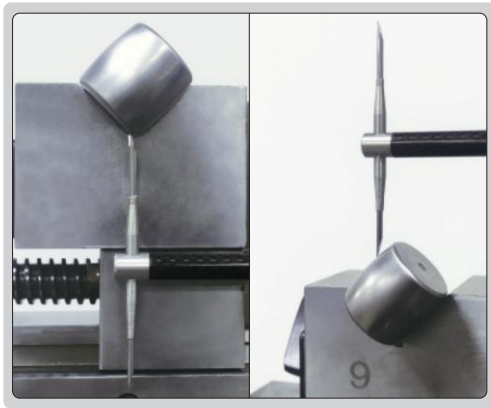

roller bearing

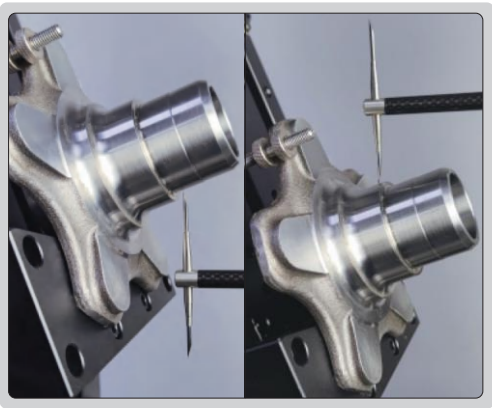

hub bearing

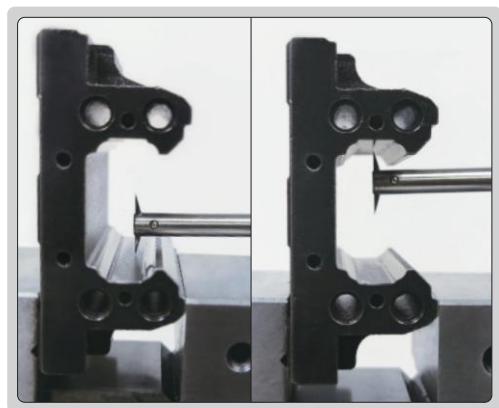

slider

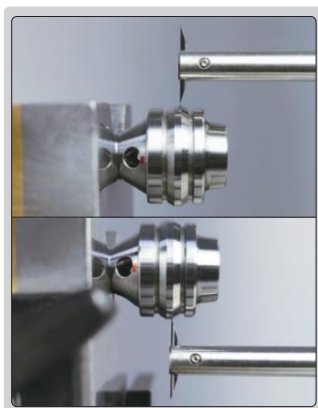

valve spool

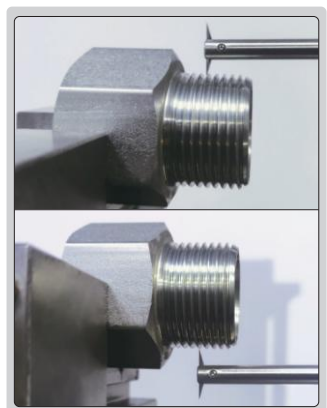

thread

To be continued

Continued from previous page

SPECIFICATION OF PROBES

Unit: mm

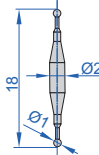
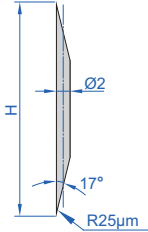
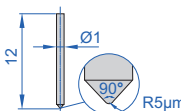
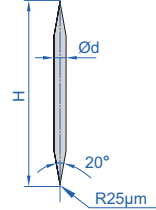
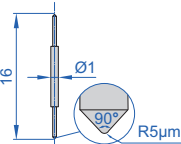
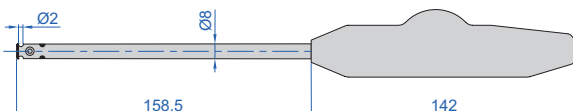
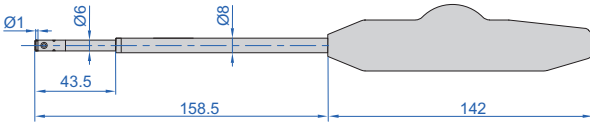
<p>bidirectional spherical stylus code SPM-6000-R01 (optional)</p> 	<p>bidirectional chisel stylus code SPM-6000-T01 (H=16mm, included) code SPM-6000-T02 (H=24mm, optional) code SPM-6000-T03 (H=30mm, optional)</p> 
<p>unidirectional roughness stylus code SPM-6000-S01 (included)</p> 	<p>bidirectional cone stylus code SPM-6000-Z01 (H=12mm, Ød=2mm, optional) code SPM-6000-Z02 (H=24mm, Ød=2mm, optional) code SPM-6000-Z03 (H=10mm, Ød=1mm, optional)</p> 
<p>bidirectional roughness stylus code SPM-6000-S02 (optional)</p> 	<p>profile arm, code SPM-6000-ARM1 (included)</p> 
	<p>roughness arm, code SPM-6000-ARM2 (included)</p> 

ROUGHNESS MEASURING MACHINE CODE SPM-4000



- Skidless probe
- Hundreds of parameters can be evaluated, such as roughness profile, waviness profile, primary profile, etc.
- Software is included, for measurement and data output

STANDARD DELIVERY

Main unit	1 pc
Roughness probe (with stylus)	1 pc
Calibration block	1 pc
Stage	1 pc
Vise	1 pc
Computer	1 pc
Software	1 set
Printer	1 pc
Installation tools	1 set

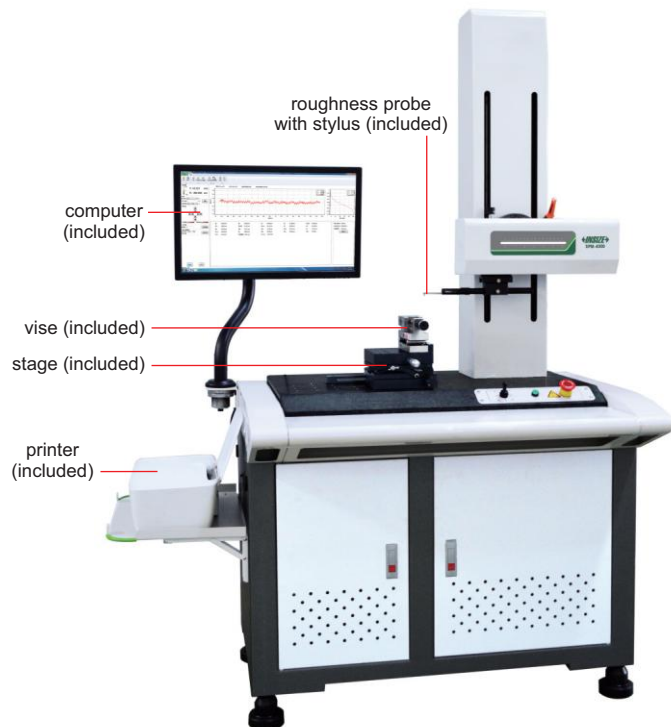

To be continued

Continued from previous page

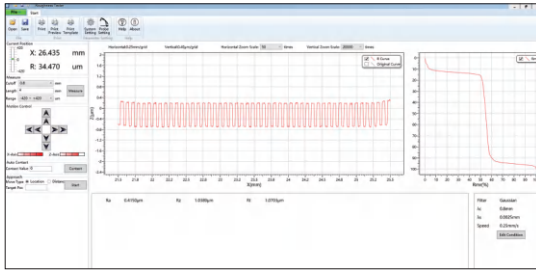

calibration

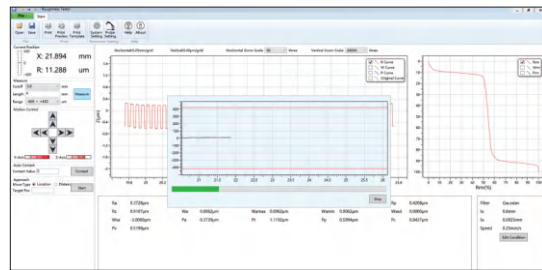

measurement

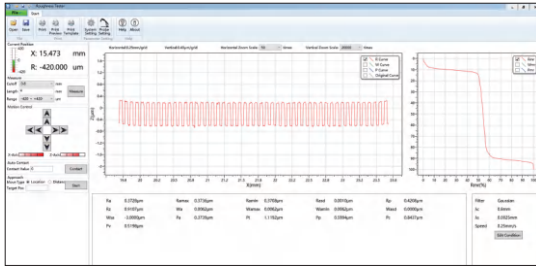

parameter measurement

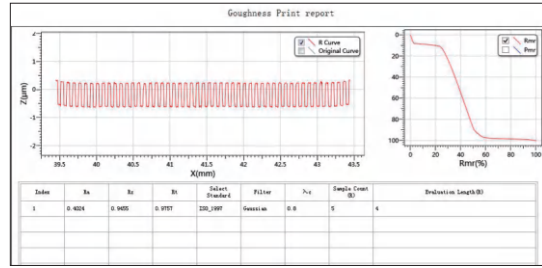

data output

SPECIFICATION

Roughness parameters	Ra, Rp, Rv, Rz, Rz (JIS), R3z, Rz (DIN), Rzj, Rmax, Rc, Rt, Rq, Rsk, Rku, Rsm, Rs, RAq, Rk, Rpk, Rvk, Mr1, Mr2, Rmr
Waviness parameters	Wa, Wt, Wp, Wv, Wz, Wq, Wsm, Wsk, Wku, Wmr
Primary profile parameters	Pa, Pt, Pp, Pv, Pz, Pq, Psm, Psk, Pku, Pmr
X axis measuring range	100mm
X axis resolution	0.2μm
X axis straightness	0.5μm/100mm
X axis moving speed	0.1~10mm/s
Z axis measuring range	±420μm
Z axis resolution	0.001μm
Z axis linear accuracy	≤±(7nm+3.5%)
Z axis moving speed	0.5~10mm/s
Z axis repeatability	1δ≤2nm
Radius/angle of stylus	5μm/90°
Cut off length	0.025/0.08/0.25/0.8/2.5/8mm
Number of cut-offs	2~7
Measuring unit	μm
Drive mode	motor
Travel of Z axis	320mm
Dimension (L×W×H)	1200×700×1780mm
Power supply	220±5%V, 50Hz
Weight	320kg



calibration block (included)



viser (included)

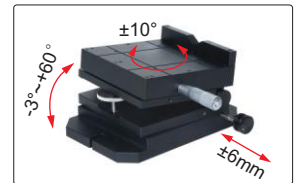

stage (included)

OPTIONAL ACCESSORY

Small roughness probe	refer to details
------------------------------	------------------

SPECIFICATION OF ROUGHNESS PROBE

Unit: mm

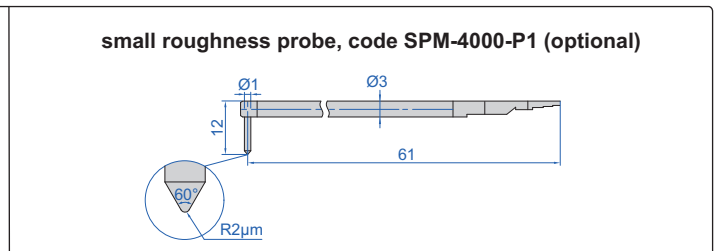
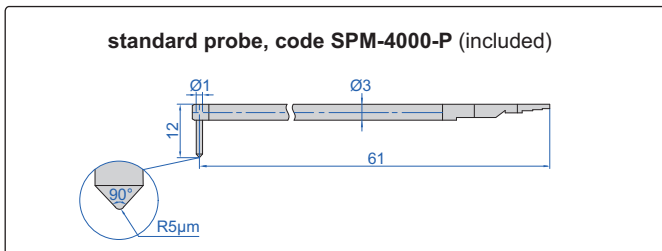

ROUGHNESS TESTER (COMPACT TYPE) CODE ISR-C200

INSIZE PLUS
MADE IN EUROPE

BLUETOOTH

DATA
OUTPUT

PROBE CAN BE CHANGED



- The product is light, reliable and durable
- 13 roughness parameters
- Can be operated by mobile phones (only Android system) or computers
- Measurement results can be exported in Excel and PDF format
- Memory of 18000 measurements with only parameters or 30 measurements with graph
- Automatic power off



probe can be set at 90°,
for transverse measurement



probe cover (included)



adjustable stand (included)

Parameter	Value	Tol.
Ra	3.423 µm	
Rq	3.932 µm	
Rt	13.277 µm	
Rz	13.090 µm	
Rc	12.463 µm	
Rmax	13.277 µm	
RSm	95.4 µm	
RPC max	105 /cm	

measuring software (included), connect to mobile phones via bluetooth (only Android system) to control roughness tester, or connect to computers via USB cable or bluetooth to control roughness tester, display roughness values and curve, results can be exported in Excel and PDF format

Continued from previous page

magnetic stand adapter (included)



dial test indicator holder (optional)

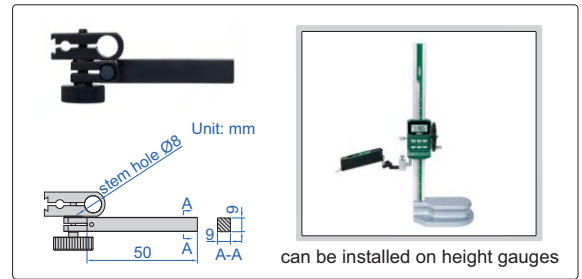

SPECIFICATION

Parameters		Ra, Rq, Rt, Rz, Rc, Rmax, RSm, Rpc, Pt, R, AR, Rx, Ppc
Range	X axis	17.5mm
	Z axis	250µm
Accuracy		±(5%+0.025)µm
Resolution (Ra)		0.001µm
Probe	type	inductive
	stylus radius/angle	2µm/90°
	stylus material	diamond
Measuring unit		µm/µin
Cut off		0.25/0.8/2.5mm
Number of cut-off		1~5
Moving speed		0.5mm/s, 1mm/s
Memory		18000 measurements with only parameters, 30 measurements with graph
Power supply		built-in rechargeable battery
Dimension (L×W×H)		160×34×33.5mm
Weight		200g

STANDARD DELIVERY

Main unit	1 pc
Standard probe	1 pc
Calibration block	1 pc
Adjustable stand	1 pc
Probe cover	1 pc
Magnetic stand adapter	1 pc
Software and USB cable	1 pc
AC/DC adapter	1 pc

OPTIONAL ACCESSORY

Dial test indicator holder	6293-6
Groove probe	ISR-C200-SB21
Small hole probe	ISR-C200-SB31
Deep groove probe	ISR-C200-SB121
Extension rod	ISR-C200-ER50
Extension rod	ISR-C200-ER100

SPECIFICATION OF PROBES

Unit: mm

<p>standard probe (included)</p> <p>measurement for plane surfaces, also transverse measurement for plane surfaces, cylinders and grooves</p>	<p>groove probe (optional), code ISR-C200-SB21</p> <p>measure plane surfaces and grooves</p>
<p>small hole probe (optional), code ISR-C200-SB31</p> <p>measure holes with diameter > Ø4mm and depth < 20mm</p>	<p>deep groove probe (optional), code ISR-C200-SB121</p> <p>measure grooves with depth < 20mm</p>
<p>extension rod (optional), code ISR-C200-ER50</p> <p>for long holes</p>	<p>extension rod (optional), code ISR-C200-ER100</p> <p>for long holes</p>

ROUGHNESS TESTER CODE ISR-C002

BLUETOOTH

DATA
OUTPUT

CAN BE OPERATED BY
MOBILE PHONES OR COMPUTERS



- Roughness tester can be operated by mobile phones (only Android system) or computers
- Data can be sent to Excel by connecting to computers via bluetooth or SPC cable
- Support bluetooth printer
- 21 roughness parameters
- Display roughness value, profile and curve
- Memory of maximum 100 results
- Automatic power off



software flash disk (included)

screen display

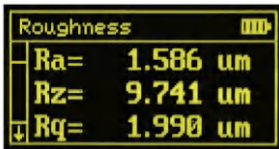

measurement result

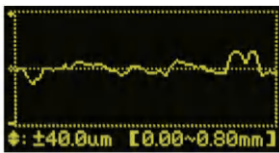

roughness profile

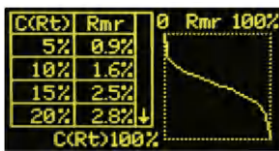

Rmr analysis

probe cover (included)



put the small workpieces directly under the probe for measurement



adjustable stand (included)



operate roughness tester by mobile phones



connect to mobile phones via bluetooth (only Android system), display roughness values, profile and curve

operate roughness tester by computers



connect to computers via USB cable (software is included), display roughness values, profile and curve

data can be sent to Excel by connecting to computer via bluetooth or SPC cable

via bluetooth

receiver (optional)



via SPC cable

SPC cable (optional)



receiver (optional)



bluetooth printer (optional)



To be continued

Continued from previous page

Unit: mm

light duty test stand (optional)



heavy duty test stand (optional)



<p>extension rod (optional), code ISR-C002-ER</p>	<p>transverse rod (optional), code ISR-C002-TR</p>
<p>tiny hole probe (optional), code ISR-C002-SBP</p>	<p>deep groove probe (optional), code ISR-C002-DGP</p>
<p>deep groove probe (optional), code ISR-C002-DGP1</p>	

SPECIFICATION

Parameters	Ra, Rz, Rq, Rv, Rp, RS, R3z, R3y, Rt, Rz (JIS), Rk, Rku, Rsm, Rpc, Rpk, Rvk, Rsk, Mr1, Mr2, Ry (JIS), Rmax	
Range	320µm (-160µm~160µm)	
Accuracy	±10%	
Resolution (Ra)	0.001µm	
Probe	type	inductive
	stylus radius/angle	5µm/90°
	stylus material	diamond
Measuring force	4mN	
Measuring unit	µm/µin	
Cut off	0.25/0.8/2.5mm	
Number of cut-off	1 to 5	
Moving speed	0.5mm/s, 1mm/s	
Memory	100 measurement results	
Output	bluetooth and USB	
Power supply	built-in rechargeable battery	
Dimension (L×W×H)	141×55×40mm	
Weight	400g	

STANDARD DELIVERY

Main unit	1 pc
Standard probe	1 pc
Calibration block and support	1 pc of each
Adjustable stand	1 pc
Probe cover	1 pc
Software and USB cable	1 pc
AC/DC adapter	1 pc

OPTIONAL ACCESSORY

Extension rod	ISR-C002-ER
Transverse rod	ISR-C002-TR
Tiny hole probe	ISR-C002-SBP
Deep groove probe	ISR-C002-DGP
Deep groove probe	ISR-C002-DGP1*
Light duty test stand	ISR-C002-STAND1
Heavy duty test stand	ISR-C002-STAND
Bluetooth printer	ISR-C002-PRINTER
Receiver	ISR-C300-RECEIVER
SPC cable	ISR-C300-SPC

*Need to be delivered with roughness tester ISR-C002

ROUGHNESS TESTER (SEPARABLE TYPE)

BLUETOOTH

TOUCH SCREEN

CAN BE OPERATED BY COMPUTERS OR MOBILE PHONES

DATA OUTPUT



POPULAR MODEL

- Roughness tester can be operated by mobile phones or computers
- Data can be sent to Excel via connecting to computers via bluetooth or SPC cable
- Support bluetooth printer
- 22 roughness parameters
- Meet ISO, DIN, ANSI, JIS standards
- Display roughness values, profile and curve
- Memory of maximum 100 data and waveform
- Built-in lithium battery, working time more than 50 hours
- Touch screen
- Automatic power off



ISR-C300

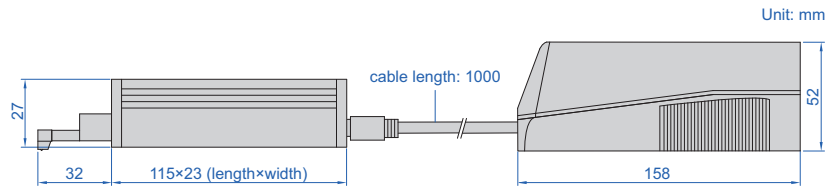

roughness tester screen display

Ra 23-05-24 12:26:27 2.50mm x 5 D-P

Ra= 4.203 μ m	Rz= 59.308 μ m
Rq= 5.989 μ m	Rt= 230.72 μ m
Rp= 45.824 μ m	Rv= 13.484 μ m
R3z= 5.83 μ m	R3y= 22.47 μ m

Navigation icons: Home, Ra, Left, Right, Back

measurement result

Lt=1.50mm(0.25*5) 00:00:00

R [LC ISO 16610-21] PC-RC

Pickup:001 μ

Ra= 0.000 μ m	Rz= 0.000 μ m
-------------------	-------------------

Navigation icons: Home, Ra, Print, Settings, Back

roughness profile

Ra 23-05-24 12:26:27 2.50mm x 5 D-P

C (Rt)	Rmr
5%	0.0%
10%	0.0%
15%	0.0%
20%	0.0%

Navigation icons: Home, Ra, Left, Right, Back

Rmr analysis



probe and main unit can be combined together

operate roughness tester by mobile phones



connect to mobile phones via bluetooth display roughness values, profile and curve



software flash disk (included)

operate roughness tester by computers

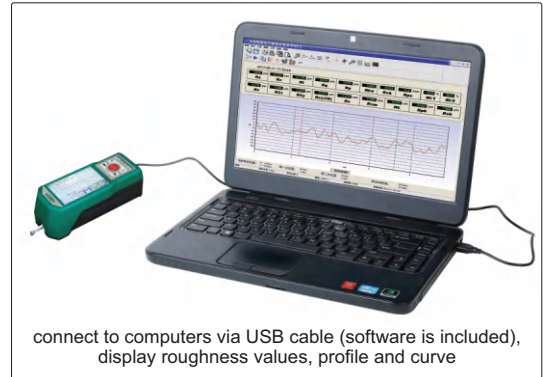

connect to computers via USB cable (software is included), display roughness values, profile and curve



bluetooth printer (optional)

To be continued

Continued from previous page

data can be sent to Excel by connecting to computer via bluetooth or SPC cable

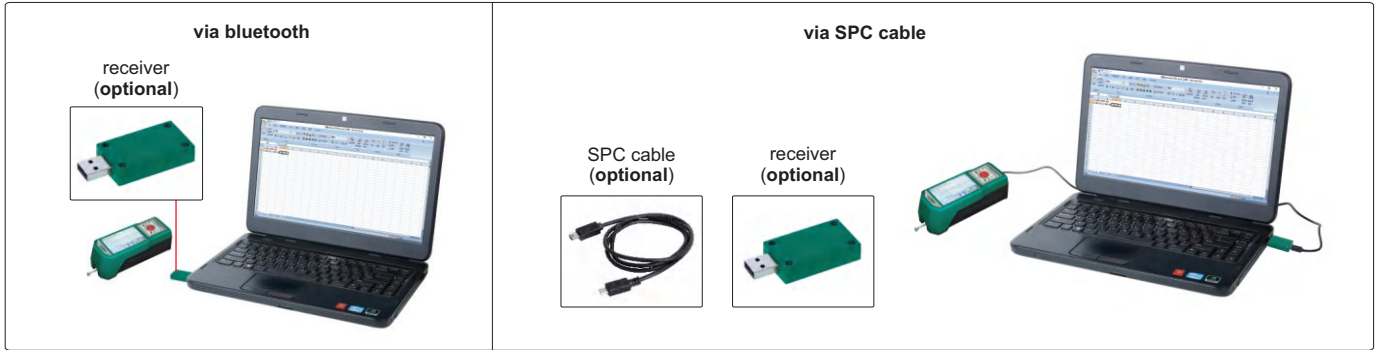

probe support (optional)

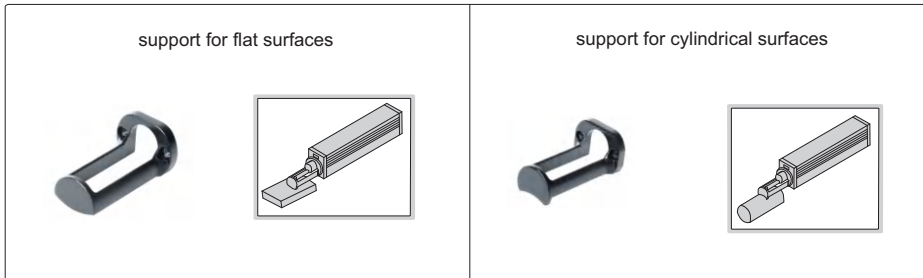

adjustable stand (included)

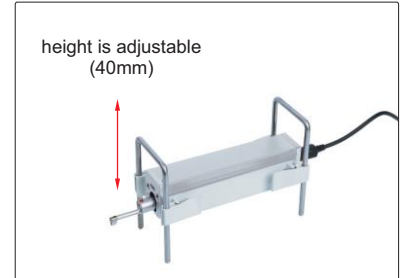

magnetic stand adapter (included)

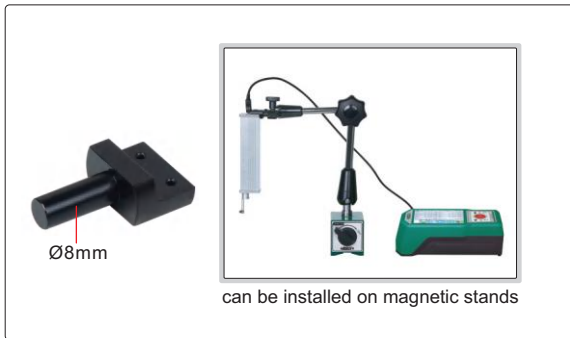

height gauge adapter (optional)



NOTE: Please check whether the adapter can fit your height gauges. When using **INSIZE** height gauges, please use the dial indicator holder of height gauges

light duty test stand (optional)

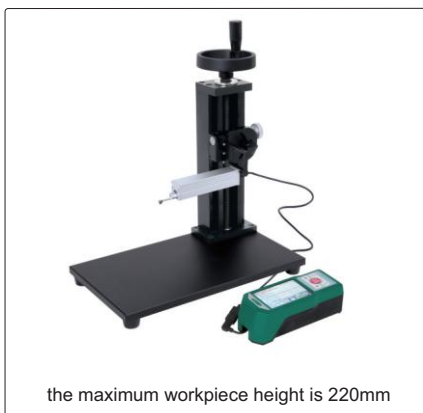

heavy duty test stand (optional)

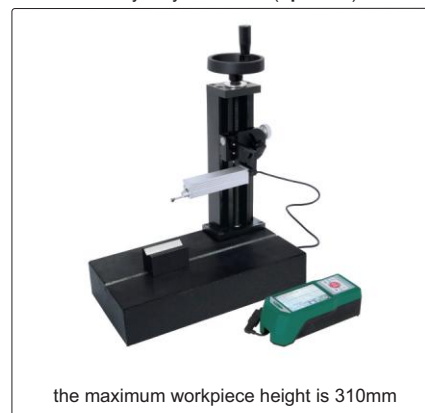

To be continued

Continued from previous page

optional probes

Unit: mm

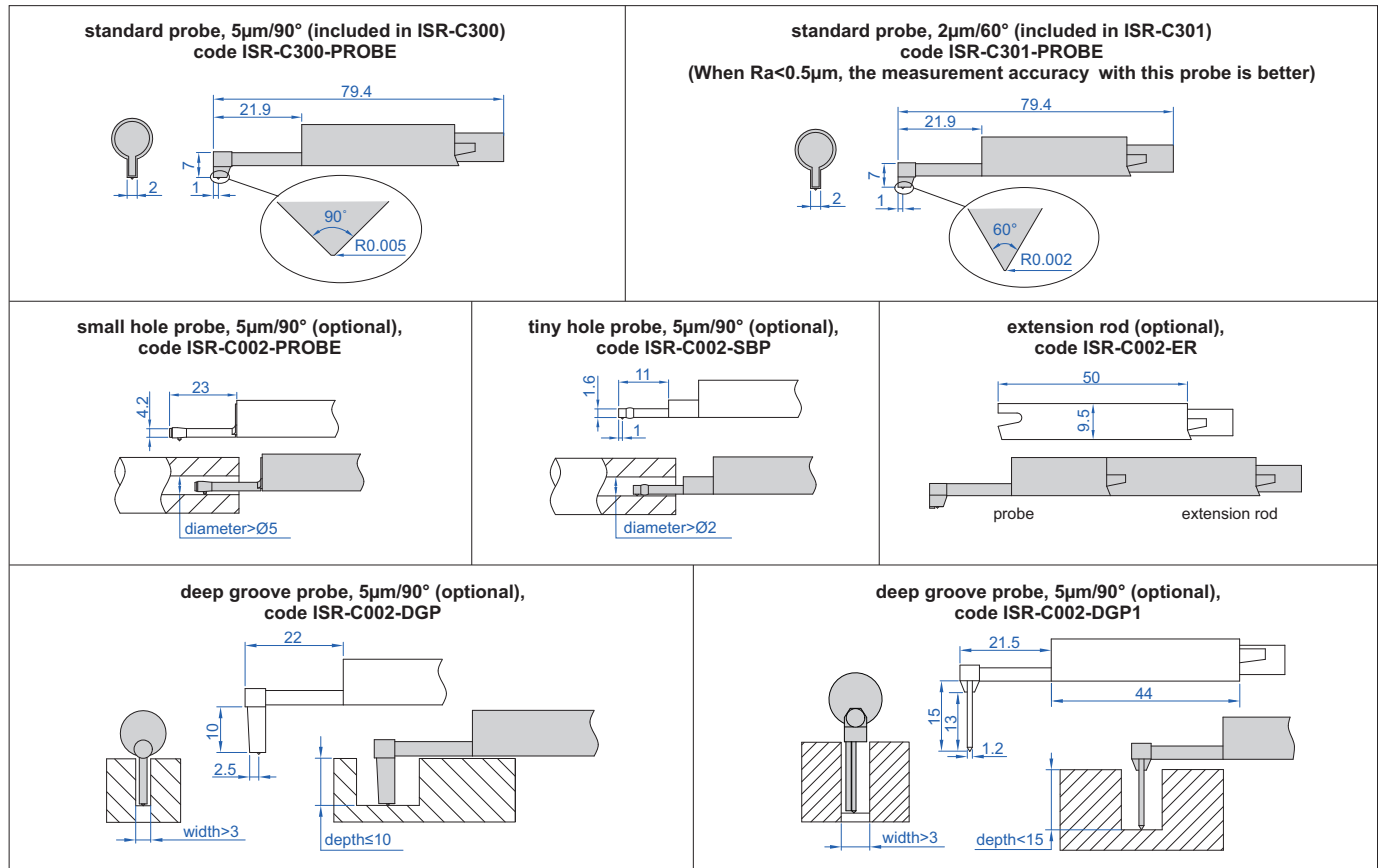

SPECIFICATION

Code	ISR-C300	ISR-C301
Measuring force	4mN	0.75mN
Stylus radius/angle	5 μ m/90°	2 μ m/60°
Parameters	Ra, Rz, Rq, Rv, Rp, Rs, R3z, R3y, Rt, Rc, Rz (JIS), Rk, Rku, Rsm, Rpc, Rpk, Rvk, Rsk, Mr1, Mr2, Ry, Rmax	
Probe type	inductive	
Stylus material	diamond	
Range	X axis	17.5mm
	Z axis	320 μ m (-160 μ m~160 μ m)
Accuracy	\pm 10%	
Resolution (Ra)	0.001 μ m	
Measuring unit	μ m/ μ in	
Cut off	0.25/0.8/2.5mm	
Number of cut-offs	1~5	
Moving speed	0.135mm/s, 0.5mm/s, 1mm/s	
Memory	100 measurement results	
Output	USB and bluetooth	
Power supply	built-in rechargeable battery	
Dimension (L×W×H)	158×64×52mm	
Weight	400g	

STANDARD DELIVERY

Main unit	1 pc
Standard probe (included in ISR-C300)	1 pc
Standard probe (included in ISR-C301)	1 pc
Calibration block and support	1 pc of each
Connecting cable (long and short)	1 pc of each
Magnetic stand adapter	1 pc
Adjustable stand	1 pc
Touch pen	1 pc
Software and USB cable	1 pc
AC/DC adapter	1 pc

OPTIONAL ACCESSORY

Extension rod	ISR-C002-ER
Small hole probe	ISR-C002-PROBE
Tiny hole probe	ISR-C002-SBP
Deep groove probe	ISR-C002-DGP
Deep groove probe	ISR-C002-DGP1*
Standard probe	ISR-C301-PROBE
Standard probe	ISR-C300-PROBE
Bluetooth printer	ISR-C002-PRINTER
Height gauge adapter	ISR-C300-LB1
Receiver	ISR-C300-RECEIVER
SPC cable	ISR-C300-SPC
Support for flat surface	ISR-C300-COVER1
Support for cylindrical surface	ISR-C300-COVER2
Light duty test stand	ISR-C002-STAND1
Heavy duty test stand	ISR-C002-STAND

*Need to be delivered with roughness tester ISR-C300

DATA OUTPUT

BLUETOOTH

TOUCH SCREEN

CAN BE OPERATED BY MOBILE PHONES OR COMPUTERS

ROUGHNESS TESTER CODE ISR-T120



- Roughness tester can be operated by mobile phones (only Android system) or computers
- Data can be sent to Excel by connecting to computers via bluetooth or SPC cable
- Built-in printer can print measurement results and graphics
- 22 roughness parameters
- Meet ISO, DIN, ANSI, JIS standards
- Display roughness values, profile and curve
- Memory of maximum 100 data and waveform
- Built-in lithium battery, working time more than 50 hours
- Automatic power off

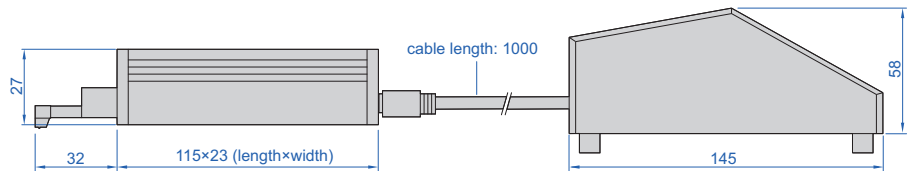
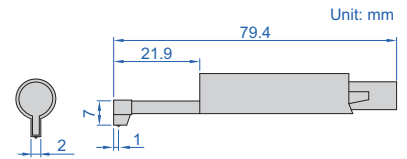

roughness tester screen display



measurement result

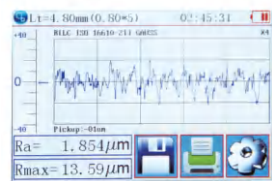

roughness profile

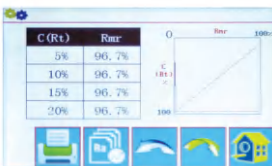

Rmr analysis

operate roughness tester by mobile phones



connect to mobile phones via bluetooth (only Android system), display roughness values, profile and curve

operate roughness tester by computers

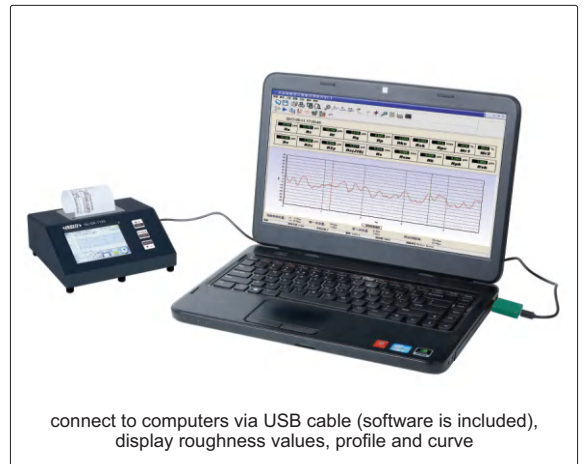



connect to computers via USB cable (software is included), display roughness values, profile and curve

To be continued

Continued from previous page

data can be sent to Excel by connecting to computer via bluetooth or SPC cable

<p>via bluetooth</p> <p>receiver (optional)</p> 	<p>via SPC cable</p> <p>SPC cable (optional)</p>  <p>receiver (optional)</p> 
--	---

probe support (optional)

support for cylindrical surface

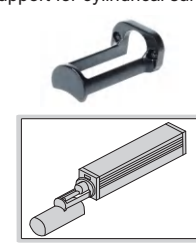

support for flat surface

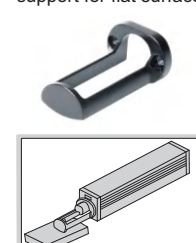

height gauge adapter (optional)



9×9mm



can be installed on height gauges

magnetic stand adapter (included)



Ø8mm



can be installed on magnetic stands

NOTE: Please check whether the adapter can fit your height gauges. When using **INSIZE** height gauges, please use the dial test indicator holder of height gauges

optional probes

Unit: mm

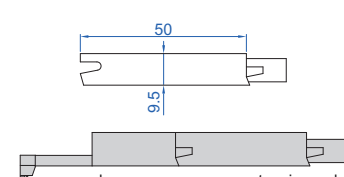
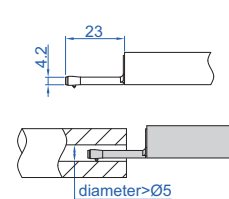
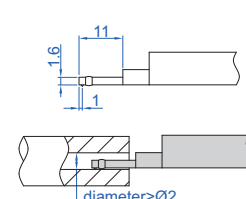
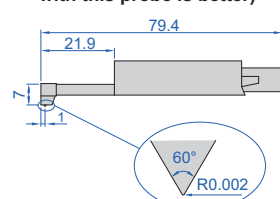
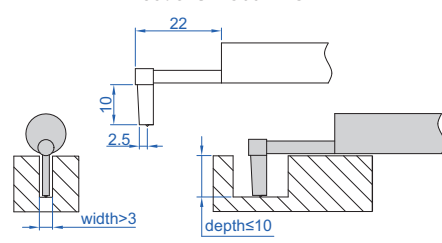
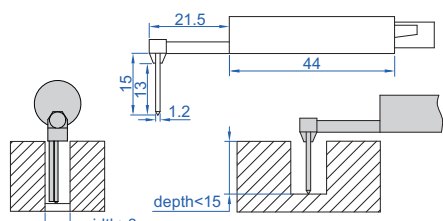
<p>extension rod (optional), code ISR-C002-ER</p>  <p>50 9.5</p> <p>probe extension rod</p>	<p>small hole probe (optional), code ISR-C002-PROBE</p>  <p>4.2 23</p> <p>diameter > Ø5</p>	<p>tiny hole probe (optional), code ISR-C002-SBP</p>  <p>1.6 11</p> <p>1</p> <p>diameter > Ø2</p>
<p>2µm/60° probe (optional), code ISR-C300-P2UM (When Ra < 0.5µm, the accuracy with this probe is better)</p>  <p>21.9 79.4</p> <p>1</p> <p>60° R0.002</p>	<p>deep groove probe (optional), code ISR-C002-DGP</p>  <p>22</p> <p>10 2.5</p> <p>width > 3 depth ≤ 10</p>	<p>deep groove probe (optional), code ISR-C002-DGP1</p>  <p>21.5 44</p> <p>15 1.2</p> <p>width > 3 depth < 15</p>

To be continued

Continued from previous page

light duty test stand (optional)



heavy duty test stand (optional)



SPECIFICATION

Parameters		Ra, Rz, Rq, Rv, Rp, Rs, R3z, R3y, Rt, Rc, Rz (JIS), Rk, Rku, Rsm, Rpc, Rpk, Rvk, Rsk, Mr1, Mr2, Ry, Rmax
Range	X axis	17.5mm
	Z axis	640µm (-320µm~320µm)
Accuracy		±10%
Resolution (Ra)		0.001µm
Probe	type	inductive
	stylus radius/angle	5µm/90°
	stylus material	diamond
Measuring force		4mN
Measuring unit		µm/µin
Cut off		0.25/0.8/2.5mm
Number of cut-offs		1~5
Traverse speed		0.135mm/s, 0.5mm/s, 1mm/s
Memory		100 measurement results
Output		bluetooth and USB
Power supply		built-in rechargeable battery
Dimension (L×W×H)		155×145×58mm
Weight		1000g

STANDARD DELIVERY

Main unit	1 pc
Standard probe	1 pc
Calibration block and support	1 pc of each
Magnetic stand adapter	1 pc
Adjustable stand	1 pc
Touch pen	1 pc
Software and USB cable	1 pc
AC/DC adapter	1 pc

OPTIONAL ACCESSORY

Extension rod	ISR-C002-ER
Small hole probe	ISR-C002-PROBE
Tiny hole probe	ISR-C002-SBP
2µm/60° probe	ISR-C300-P2UM
Deep groove probe	ISR-C002-DGP
Deep groove probe	ISR-C002-DGP1 *
Height gauge adapter	ISR-C300-LB1
Receiver	ISR-C300-RECEIVER
SPC cable	ISR-C300-SPC
Support for flat surface	ISR-C300-COVER1
Support for cylindrical surface	ISR-C300-COVER2
Light duty test stand	ISR-C002-STAND1
Heavy duty test stand	ISR-C002-STAND

*Need to be delivered with roughness tester ISR-T120

ROUGHNESS TESTER (BASIC TYPE) CODE ISR-C003

ATTENTION: THIS ROUGHNESS TESTER IS NOT SUITABLE FOR ROUGH TURNING, MILLING AND PLANING WORKPIECES

- Unit: μm , μin
- Automatic power off



SPECIFICATION

Parameters*		Ra, Rz, Rq, Rt
Range		Ra, Rq: 0.05~15 μm Rz, Rt: 0.1~50 μm
Accuracy		$\pm 10\%$
Resolution (Ra)		0.01 μm
Probe	type	piezoelectric
	stylus radius/angle	10 $\mu\text{m}/90^\circ$
	stylus material	diamond
Measuring force		5mN
Measuring unit		$\mu\text{m}/\mu\text{in}$
Cut off		0.25/0.8/2.5mm
Evaluation length		1.25mm for cut off 0.25mm 4mm for cut off 0.8mm 5mm for cut off 2.5mm
Moving speed		0.75mm/s
Power supply		built-in rechargeable battery
Dimension (L×W×H)		106×70×24mm
Weight		200g

* Rmax parameter can be customized

STANDARD DELIVERY

Main unit	1 pc
Calibration block	1 pc
AC/DC adapter	1 pc



fixture for small shafts (optional)



clamping range:
 $\varnothing 3\sim 20\text{mm}$

application



calibration block (included)

OPTIONAL ACCESSORY

Fixture for small shafts	ISR-C003-FIXTURE
--------------------------	------------------

SURFACE ROUGHNESS SPECIMEN SET CODE ISR-CS130-W

INSIZE PLUS
MADE IN EUROPE

- For checking, identifying and specifying the roughness by symbol
- Rust-proof, made of pure Nickel



Machining method	Roughness (Ra)*	Roughness (Rz)*	Quantity
Flat lapping	0.05, 0.1, 0.2 μm	0.55, 1, 1.6 μm	3 pcs
	2, 4, 8 μin		
Reaming	0.4, 0.8, 1.6 μm	3, 6, 10 μm	3 pcs
	16, 32, 63 μin		
Plain grinding	0.05, 0.1, 0.2, 0.4, 0.8, 1.6 μm	0.55, 1, 1.6, 3, 6, 10 μm	6 pcs
	2, 4, 8, 16, 32, 63 μin		
Horizontal milling	0.4, 0.8, 1.6, 3.2, 6.3, 12.5 μm	2.5, 4, 8, 16, 32, 50 μm	6 pcs
	16, 32, 63, 125, 250, 500 μin		
Vertical milling	0.4, 0.8, 1.6, 3.2, 6.3, 12.5 μm	2.5, 4, 8, 16, 32, 50 μm	6 pcs
	16, 32, 63, 125, 250, 500 μin		
Turning	0.4, 0.8, 1.6, 3.2, 6.3, 12.5 μm	2.5, 4, 8, 16, 32, 50 μm	6 pcs
	16, 32, 63, 125, 250, 500 μin		

* The actual value is the value to be calibrated

ATTENTION: PLEASE APPLY ANTI-RUST OIL AFTER USE

SURFACE ROUGHNESS SPECIMEN SET CODE ISR-CS2

- For checking, identifying and specifying the roughness by symbol
- Made of carbon steel

Machining method	Roughness (Ra) *	Roughness (Rz) *	Quantity
Horizontal milling	0.4, 0.8, 1.6, 3.2, 6.3, 12.5µm	1.6, 3.2, 6.3, 12.5, 25, 50µm	6 pcs
Vertical milling	0.4, 0.8, 1.6, 3.2, 6.3, 12.5µm	1.6, 3.2, 6.3, 12.5, 25, 50µm	6 pcs
Turning	0.4, 0.8, 1.6, 3.2, 6.3, 12.5µm	1.6, 3.2, 6.3, 12.5, 25, 50µm	6 pcs
Plain grinding	0.05, 0.1, 0.2, 0.4, 0.8, 1.6µm	0.2, 0.4, 0.8, 1.6, 3.2, 6.3µm	6 pcs
Flat lapping	0.05, 0.1µm	0.2, 0.4µm	2 pcs
External grinding	0.2, 0.4, 0.8, 1.6µm	0.8, 1.6, 3.2, 6.3µm	4 pcs

* The actual value is the value to be calibrated



SURFACE ROUGHNESS SPECIMENS

INSIZE PLUS
MADE IN EUROPE

- For checking, identifying and specifying the roughness by symbol
- Rust-proof, made of pure Nickel



ISR-CS315

Code	Machining method	Roughness (Ra) *	Roughness (Rz) *	Quantity
ISR-CS315	surface grinding	0.025, 0.05, 0.1, 0.2, 0.4, 0.8, 1.6, 3.2µm	0.29, 0.55, 0.91, 1.74, 2.6, 4.65, 7.87, 15.6µm	8 pcs
ISR-CS316	cylindrical grinding	0.025, 0.05, 0.1, 0.2, 0.4, 0.8, 1.6, 3.2µm	0.3, 0.53, 0.88, 1.56, 2.64, 4.4, 7.71, 15.3µm	8 pcs
ISR-CS317	flat lapping	criss-cross	0.025, 0.05, 0.1, 0.2µm	0.4, 0.6, 0.74, 1.26µm
		parallel	0.025, 0.05, 0.1, 0.2µm	0.34, 0.56, 1.12, 1.5µm
ISR-CS318	cylindrical lapping	0.025, 0.05, 0.1, 0.2µm	0.46, 0.54, 0.63, 1.23µm	4 pcs
	superfinishing	0.025, 0.05, 0.1, 0.2µm	0.36, 0.7, 1, 1.4µm	4 pcs
ISR-CS319	face turning	0.4, 0.8, 1.6, 3.2, 6.3, 12.5, 25, 50µm	1.92, 3.2, 6.15, 12.5, 23.7, 48.7, 102, 185µm	8 pcs
ISR-CS320	cylindrical turning	0.4, 0.8, 1.6, 3.2, 6.3, 12.5, 25, 50µm	1.7, 3.2, 6.1, 12.2, 23.7, 47.5, 95, 190µm	8 pcs
ISR-CS321	end milling	0.4, 0.8, 1.6, 3.2, 6.3, 12.5, 25, 50µm	1.92, 3.82, 6.45, 12.2, 25.2, 49.8, 92.6, 191µm	8 pcs
ISR-CS322	reaming	0.4, 0.8, 1.6, 3.2µm	1.7, 3.2, 6.4, 12.8µm	4 pcs
	drilling	1.6, 3.2, 6.3, 12.5µm	7.5, 15.5, 31, 60µm	4 pcs
ISR-CS323	horizontal milling	0.4, 0.8, 1.6, 3.2, 6.3, 12.5, 25, 50µm	1.8, 3.68, 6.63, 12.8, 25.6, 53, 97.5, 197µm	8 pcs
ISR-CS325	shaping (planing)	0.8, 1.6, 3.2, 6.3, 12.5, 25, 50, 100µm	3.84, 6.7, 12.2, 25.2, 48.7, 99.9, 190, 361µm	8 pcs
ISR-CS326	linishing (belt sanding)	0.1, 0.2, 0.4, 0.8, 1.6, 3.2µm	0.9, 1.55, 3.37, 7.42, 18.5, 31µm	6 pcs
ISR-CS328	vertical grinding	0.2, 0.4, 0.8, 1.6, 3.2, 6.3µm	1.1, 3.5, 6.15, 8.78, 22.19, 40.8µm	6 pcs
ISR-CS329	grit blasting	3.2, 10.5, 18, 25µm	19.2, 63, 108, 150µm	4 pcs
	shot blasting	3.2, 8, 13, 18µm	19.2, 48, 78, 108µm	4 pcs
ISR-CS331	spark erosion (EDM)	0.4, 0.8, 1.6, 3.2, 6.3, 12.5, 25, 50µm	2.5, 4.5, 7.2, 14.2, 24.7, 51.2, 105, 196µm	8 pcs
ISR-CS333	hand filing	0.4, 0.8, 1.6, 3.2, 6.3µm	3, 5.6, 12.4, 22.5, 61µm	5 pcs
ISR-CS334	castings	0.8, 1.6, 3.2, 6.3, 12.5, 25, 50µm	3.2, 8, 16, 32, 56, 112, 225µm	7 pcs
ISR-CS335	honing	0.05, 0.1, 0.2, 0.4, 0.8, 1.6µm	0.31, 0.56, 1, 2, 4.2, 9µm	6 pcs
ISR-CS336	polishing	0.0125, 0.025, 0.05, 0.1, 0.2µm	0.29, 0.35, 0.67, 0.72, 1.52µm	5 pcs

* The actual value is the value to be calibrated

SHOT AND GRIT BLASTING SURFACE ROUGHNESS SPECIMENS

INSIZE PLUS
MADE IN EUROPE

- To check the roughness of steel surfaces which have been blast cleaned before painting
- Meets ISO 8503/1
- Rust-proof, made of pure Nickel
- Each piece contains 4 parts

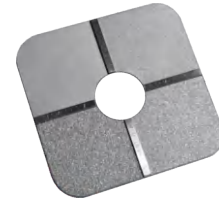

ISR-CS017

Code	Machining method	Roughness (Ra) *	Roughness (Rz) *
ISR-CS017	shot blasting	3.2, 8, 13, 18µm	19.2, 48, 78, 108µm
ISR-CS018	grit blasting	3.2, 10.5, 18, 25µm	19.2, 63, 108, 150µm

* The actual value is the value to be calibrated

SURFACE ROUGHNESS REFERENCE SPECIMENS

INSIZE PLUS
MADE IN EUROPE

MEASURING ACCURACY OF ROUGHNESS TESTERS CAN BE IMPROVED, IF THE CALIBRATION IS MADE ON A REFERENCE SPECIMEN WITH THE ROUGHNESS VALUE CLOSE TO THE WORKPIECE TO BE MEASURED

- To calibrate roughness testers
- Meets ISO 5436-1: 2000
- Rust proof, made of pure Nickel

Code	Roughness (Ra)
ISR-RS525X	6.25µm *
ISR-RS526X	3.15µm *
ISR-RS527X	3.0µm *
ISR-RS528X	0.5µm *
ISR-RS529X	0.1µm *
ISR-RS530X	1.0µm *
ISR-RS531X	0.3µm *

* The actual value may be slightly different

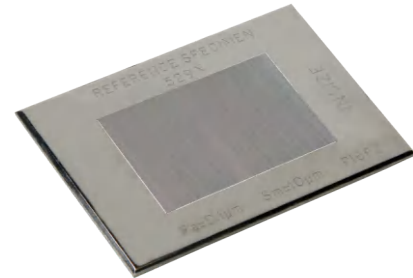

ISR-RS529X

SURFACE ROUGHNESS REFERENCE SPECIMENS

MEASURING ACCURACY OF ROUGHNESS TESTERS CAN BE IMPROVED, IF THE CALIBRATION IS MADE ON A REFERENCE SPECIMEN WITH THE ROUGHNESS VALUE CLOSE TO THE WORKPIECE TO BE MEASURED

- To calibrate roughness testers
- Made of glass

Code	Roughness (Ra)	Deviation *	Uniformity
ISR-LS601	0.1µm	-20% ~ +10%	3%
ISR-LS602	0.2µm	±10%	3%
ISR-LS603	0.4µm	±10%	3%
ISR-LS604	0.8µm	±10%	3%
ISR-LS605	1.6µm	±10%	3%
ISR-LS606	3.2µm	±10%	2%
ISR-LS607	6.4µm	±10%	2%

* Deviation between the actual value when supply and the nominal value



ISR-LS603



CMM
Page 607-612



Measuring Arms
Page 613-615



Styli For CMM
Page 616-617



Ceramic Ball Gauges
Page 617-618



Gauge Block Stands For CMM
Page 618

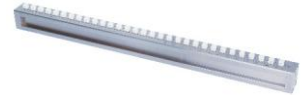

CMM Check Masters
Page 619-621



Jigs For CMM
Page 622-628

COORDINATE MEASURING MACHINES (LARGE RANGE)



FEATURES

- Classic bridge structure, integrated workbench
- High precision air bearing
- Special non-linear spring system to minimize guide way error

RENISHAW SYSTEMS

- Precision grating system, including grating and data acquisition device
- UCC control system, including control box and manual operator
- Probe system, including probe head, probe body and styli



CMM-PM10128A

Visual DMIS CNC CAD+ SOFTWARE

- The software is designed and developed based on the DMIS standard, with excellent compatibility and versatility
- Geometric element measurement, evaluation of shape and position
- Bidirectional data transfer with mainstream CAD systems, complete graphical display
- Optional specialized modules, such as gear module, worm module, pipeline module, blade module, SPC data analysis module, etc.

STANDARD ACCURACY (PM SERIES)

Code	Range (X×Y×Z)	Probe system		Accuracy		Max. load	Overall dimension (mm)	Weight (kg)
		Head	Body	MPEE (μm)	MPEP			
CMM-PM686A	600×800×600mm	PH10T	TP20	±(2.1+L/300)	2.4μm	800kg	1485×1800×2730	1650
CMM-PM686B		PH10M	SP25M	±(1.5+L/300)	1.5μm			
CMM-PM8127A	800×1200×700mm	PH10T	TP20	±(2.3+L/300)	2.6μm	1000kg	1685×2200×2900	2600
CMM-PM8127B		PH10M	SP25M	±(1.7+L/300)	1.7μm			
CMM-PM8157A	800×1500×700mm	PH10T	TP20	±(2.3+L/300)	2.6μm	1000kg	1685×2500×2930	3000
CMM-PM8157B		PH10M	SP25M	±(1.7+L/300)	1.7μm			
CMM-PM10128A	1000×1200×800mm	PH10T	TP20	±(2.7+L/300)	3.0μm	1500kg	1885×2200×3130	2900
CMM-PM10128B		PH10M	SP25M	±(2.1+L/300)	2.1μm			
CMM-PM10158A	1000×1500×800mm	PH10T	TP20	±(2.7+L/300)	3.0μm	1500kg	1885×2500×3130	3300
CMM-PM10158B		PH10M	SP25M	±(2.1+L/300)	2.1μm			
CMM-PM10228A	1000×2200×800mm	PH10T	TP20	±(2.7+L/300)	3.0μm	1800kg	1885×3580×3130	4200
CMM-PM10228B		PH10M	SP25M	±(2.1+L/300)	2.1μm			
CMM-PM10258A	1000×2500×800mm	PH10T	TP20	±(2.7+L/300)	3.0μm	1800kg	1885×3880×3070	5200
CMM-PM10258B		PH10M	SP25M	±(2.1+L/300)	2.1μm			
CMM-PM10308A	1000×3000×800mm	PH10T	TP20	±(2.7+L/300)	3.0μm	1800kg	1885×4380×3070	5900
CMM-PM10308B		PH10M	SP25M	±(2.1+L/300)	2.1μm			
CMM-PM121510A	1200×1500×1000mm	PH10T	TP20	±(3.1+L/300)	3.4μm	2000kg	2085×2500×3530	3600
CMM-PM121510B		PH10M	SP25M	±(2.5+L/300)	2.5μm			

To be continued



Continued from previous page

STANDARD ACCURACY (PM SERIES)

Code	Range (X×Y×Z)	Probe system		Accuracy		Max. load	Overall dimension (mm)	Weight (kg)
		Head	Body	MPEE (µm)	MPEP			
CMM-PM12210A	1200×2200×1000mm	PH10T	TP20	±(3.1+L/300)	3.4µm	2000kg	2085×3580×3530	4600
CMM-PM12210B		PH10M	SP25M	±(2.5+L/300)	2.5µm			
CMM-PM122510A	1200×2500×1000mm	PH10T	TP20	±(3.1+L/300)	3.4µm	2000kg	2085×3880×3470	5500
CMM-PM122510B		PH10M	SP25M	±(2.5+L/300)	2.5µm			
CMM-PM123010A	1200×3000×1000mm	PH10T	TP20	±(3.1+L/300)	3.4µm	2000kg	2085×4380×3470	6500
CMM-PM123010B		PH10M	SP25M	±(2.5+L/300)	2.5µm			
CMM-PM152210A	1500×2200×1000mm	PH10T	TP20	±(3.5+L/300)	3.8µm	2200kg	2385×3580×3470	5900
CMM-PM152210B		PH10M	SP25M	±(2.9+L/300)	2.9µm			
CMM-PM152510A	1500×2500×1000mm	PH10T	TP20	±(3.5+L/300)	3.8µm	2200kg	2385×3880×3470	6500
CMM-PM152510B		PH10M	SP25M	±(2.9+L/300)	2.9µm			
CMM-PM153010A	1500×3000×1000mm	PH10T	TP20	±(3.5+L/300)	3.8µm	2200kg	2385×4380×3470	7500
CMM-PM153010B		PH10M	SP25M	±(2.9+L/300)	2.9µm			
CMM-PM182510A	1800×2500×1000mm	PH10T	TP20	±(3.9+L/300)	4.2µm	2500kg	2685×3880×3470	7300
CMM-PM182510B		PH10M	SP25M	±(3.3+L/300)	3.3µm			
CMM-PM183010A	1800×3000×1000mm	PH10T	TP20	±(3.9+L/300)	4.2µm	2500kg	2685×4380×3470	8500
CMM-PM183010B		PH10M	SP25M	±(3.3+L/300)	3.3µm			
CMM-PM183510A	1800×3500×1000mm	PH10T	TP20	±(3.9+L/300)	4.2µm	2500kg	2685×4880×3470	9700
CMM-PM183510B		PH10M	SP25M	±(3.3+L/300)	3.3µm			
CMM-PM184010A	1800×4000×1000mm	PH10T	TP20	±(3.9+L/300)	4.2µm	2500kg	2685×5380×3470	10800
CMM-PM184010B		PH10M	SP25M	±(3.3+L/300)	3.3µm			

HIGH ACCURACY (PE SERIES)

Code	Range (X×Y×Z)	Probe system		Accuracy		Max. load	Overall dimension (mm)	Weight (kg)
		Head	Body	MPEE (µm)	MPEP			
CMM-PE686A	600×800×600mm	PH10T	TP20	±(1.8+L/350)	2.0µm	800kg	1485×1800×2730	1650
CMM-PE686B		PH10M	SP25M	±(1.2+L/350)	1.2µm			
CMM-PE8127A	800×1200×700mm	PH10T	TP20	±(2.0+L/350)	2.2µm	1000kg	1685×2200×2900	2600
CMM-PE8127B		PH10M	SP25M	±(1.4+L/350)	1.4µm			
CMM-PE8157A	800×1500×700mm	PH10T	TP20	±(2.0+L/350)	2.2µm	1000kg	1685×2500×2930	3000
CMM-PE8157B		PH10M	SP25M	±(1.4+L/350)	1.4µm			
CMM-PE10128A	1000×1200×800mm	PH10T	TP20	±(2.3+L/350)	2.5µm	1500kg	1885×2200×3130	2900
CMM-PE10128B		PH10M	SP25M	±(1.7+L/350)	1.7µm			
CMM-PE10158A	1000×1500×800mm	PH10T	TP20	±(2.3+L/350)	2.5µm	1500kg	1885×2500×3130	3300
CMM-PE10158B		PH10M	SP25M	±(1.7+L/350)	1.7µm			
CMM-PE10228A	1000×2200×800mm	PH10T	TP20	±(2.3+L/350)	2.5µm	1800kg	1885×3580×3130	4200
CMM-PE10228B		PH10M	SP25M	±(1.7+L/350)	1.7µm			
CMM-PE10258A	1000×2500×800mm	PH10T	TP20	±(2.3+L/350)	2.5µm	1800kg	1885×3880×3070	5200
CMM-PE10258B		PH10M	SP25M	±(1.7+L/350)	1.7µm			
CMM-PE10308A	1000×3000×800mm	PH10T	TP20	±(2.3+L/350)	2.5µm	1800kg	1885×4380×3070	5900
CMM-PE10308B		PH10M	SP25M	±(1.7+L/350)	1.7µm			
CMM-PE121510A	1200×1500×1000mm	PH10T	TP20	±(2.7+L/350)	2.9µm	2000kg	2085×2500×3530	3600
CMM-PE121510B		PH10M	SP25M	±(2.1+L/350)	2.1µm			

Continued from previous page

HIGH ACCURACY (PE SERIES)

Code	Range (X×Y×Z)	Probe system		Accuracy		Max. load	Overall dimension (mm)	Weight (kg)
		Head	Body	MPEE (μm)	MPEP			
CMM-PE12210A	1200×2200×1000mm	PH10T	TP20	±(2.7+L/350)	2.9μm	2000kg	2085×3580×3530	4600
CMM-PE12210B		PH10M	SP25M	±(2.1+L/350)	2.1μm			
CMM-PE122510A	1200×2500×1000mm	PH10T	TP20	±(2.7+L/350)	2.9μm	2000kg	2085×3880×3470	5500
CMM-PE122510B		PH10M	SP25M	±(2.1+L/350)	2.1μm			
CMM-PE123010A	1200×3000×1000mm	PH10T	TP20	±(2.7+L/350)	2.9μm	2000kg	2085×4380×3470	6500
CMM-PE123010B		PH10M	SP25M	±(2.1+L/350)	2.1μm			
CMM-PE152210A	1500×2200×1000mm	PH10T	TP20	±(3.1+L/350)	3.3μm	2200kg	2385×3580×3470	5900
CMM-PE152210B		PH10M	SP25M	±(2.5+L/350)	2.5μm			
CMM-PE152510A	1500×2500×1000mm	PH10T	TP20	±(3.1+L/350)	3.3μm	2200kg	2385×3880×3470	6500
CMM-PE152510B		PH10M	SP25M	±(2.5+L/350)	2.5μm			
CMM-PE153010A	1500×3000×1000mm	PH10T	TP20	±(3.1+L/350)	3.3μm	2200kg	2385×4380×3470	7500
CMM-PE153010B		PH10M	SP25M	±(2.5+L/350)	2.5μm			
CMM-PE182510A	1800×2500×1000mm	PH10T	TP20	±(3.5+L/350)	3.7μm	2500kg	2685×3880×3470	7300
CMM-PE182510B		PH10M	SP25M	±(2.9+L/350)	2.9μm			
CMM-PE183010A	1800×3000×1000mm	PH10T	TP20	±(3.5+L/350)	3.7μm	2500kg	2685×4380×3470	8500
CMM-PE183010B		PH10M	SP25M	±(2.9+L/350)	2.9μm			
CMM-PE183510A	1800×3500×1000mm	PH10T	TP20	±(3.5+L/350)	3.7μm	2500kg	2685×4880×3470	9700
CMM-PE183510B		PH10M	SP25M	±(2.9+L/350)	2.9μm			
CMM-PE184010A	1800×4000×1000mm	PH10T	TP20	±(3.5+L/350)	3.7μm	2500kg	2685×5380×3470	10800
CMM-PE184010B		PH10M	SP25M	±(2.9+L/350)	2.9μm			

STANDARD DELIVERY

Main unit		1 pc
Probe system	probe head	1 pc
	probe body	1 pc
	styli	1 set
Control system		1 set
Calibration sphere		1 pc
Universal sphere seat		1 pc
Computer		1 pc
Printer		1 pc
Software		1 set
Table and chair		1 set

OPERATION ENVIRONMENT

Air pressure	0.6-0.8MPa
Air supply	200L/min
Temperature	20±2°C; <0.5°C/h, <1°C/24h
Humidity	30%~70%
Max. power	1000W
Power supply	220V±5%, 50Hz

Continued from previous page

PH10T AND PH10M SPECIFICATION

Angular movement with horizontal axis	0°~105° in 7.5 steps
Angular movement with vertical axis	±180° in 7.5 steps
Number of positions	720
Steering mode	motorized
Max. output torque	0.45N.m
Max. extension length	300mm
Weight	649g

STYLI SET INCLUDED IN TP20

Type	Material	Ball diameter	Length	Stem diameter	Effective working length	Quantity
Styli	ruby ball / stainless steel stem	SØ2.5mm	20mm	Ø1.4mm	14mm	4 pcs
		SØ4mm		Ø1.5mm	20mm	1 pc
		SØ3mm	10mm	Ø1.5mm	7.5mm	1 pc

Type	Material	Diameter	Length	Quantity
Extension	stainless steel	Ø3mm	20mm	1 pc
		Ø3mm	30mm	1 pc

Type	Material	Diameter	Length	Quantity
Center base	stainless steel	7mm	7.5mm	1 pc

STYLI SET INCLUDED IN SP25M

Type	Material	Ball diameter	Length	Stem diameter	Effective working length	Quantity
Styli	ruby ball/ stainless steel stem	SØ1.5mm	21mm	Ø1mm	14mm	1 pc
		SØ2mm		Ø1.4mm	8mm	1 pc
		SØ3mm	Ø1.5mm	12mm	4 pcs	
		SØ4mm	Ø2.5mm	27mm	1 pc	
	ruby ball/ carbon fiber stem	SØ5mm	50mm	Ø3mm	42.5mm	1 pc
		SØ6mm	75mm	Ø4mm	75mm	1 pc

Type	Material	Diameter	Length	Quantity
Extension	stainless steel	Ø5mm	10mm	1 pc
		Ø4mm	20mm	1 pc

Type	Material	Diameter	Length	Quantity
Center base	stainless steel	10mm	13mm	1 pc

COORDINATE MEASURING MACHINES (SMALL RANGE)



FEATURES

- Classic bridge structure, integrated workbench
- High precision air bearing
- Unique Z-axis anti torque design to reduce rotation error

RENISHAW SYSTEMS

- Precision grating system, including grating and data acquisition device
- UCC control system, including control box and manual operator
- Probe system, including probe head, probe body and styli

VISUAL DMIS CNC CAD+SOFTWARE

- The software is designed and developed based on the DMIS standard, with excellent compatibility and versatility
- Geometric element measurement, evaluation of shape and position
- Bidirectional data transmission with mainstream CAD systems, complete graphical display
- Optional specialized modules, such as gear module, worm module, pipeline module, blade module, SPC data analysis module, etc.



CMM-LM564A

STANDARD DELIVERY

Main unit		1 pc
Probe system	probe head	1 pc
	probe body	1 pc
	styli	1 set
Control system		1 set
Calibration sphere		1 pc
Universal sphere seat		1 pc
Computer		1 pc
Printer		1 pc
Software		1 set
Table and chair		1 set

OPERATION ENVIRONMENT

Air pressure	0.6-0.8MPa
Air supply	200L/min
Temperature	20°C±2°C; <0.5°C/h, <1°C/24h
Humidity	30%~70%
Max. power	1000W
Power supply	220V±5%, 50Hz

STANDARD ACCURACY (LM SERIES)

Code	Range (X×Y×Z)	Probe system		Accuracy		Max. load	Overall dimension (mm)	Weight (kg)
		Head	Body	MPEE (μm)	MPEP			
CMM-LM564A	500×600×400mm	MH20i	TP20	±(2.3+L/250)	2.4μm	500kg	1135×1420×2350	900
CMM-LM564B		PH10T						
CMM-LM686A	600×800×600mm	MH20i	TP20	±(2.6+L/250)	2.7μm	800kg	1420×1740×2760	1300
CMM-LM686B		PH10T						
CMM-LM686C		PH10M						
CMM-LM8106A	800×1000×600mm	MH20i	TP20	±(2.7+L/250)	2.8μm	1000kg	1620×1940×2760	1700
CMM-LM8106B		PH10T						
CMM-LM8106C		PH10M						
CMM-LM8126A	800×1200×600mm	MH20i	TP20	±(2.7+L/250)	2.8μm	1000kg	1620×2140×2760	1900
CMM-LM8126B		PH10T						
CMM-LM8126C		PH10M						
CMM-LM8156A	800×1500×600mm	MH20i	TP20	±(2.7+L/250)	2.8μm	1000kg	1620×2440×2760	2200
CMM-LM8156B		PH10T						
CMM-LM8156C		PH10M						

To be continued



Continued from previous page

HIGH ACCURACY (LE SERIES)

Code	Range (X×Y×Z)	Probe system		Accuracy		Max. load	Overall dimension (mm)	Weight (kg)
		Head	Body	MPEE (μm)	MPEP			
CMM-LE564A	500×600×400mm	MH20i	TP20	±(1.9+L/330)	2.1μm	500kg	1135×1420×2350	900
CMM-LE564B		PH10T						
CMM-LE686A	600×800×600mm	MH20i	TP20	±(2.0+L/330)	2.2μm	800kg	1420×1740×2760	1300
CMM-LE686B		PH10T						
CMM-LE686C		PH10M	SP25M	±(1.6+L/330)	1.6μm			
CMM-LE8106A	800×1000×600mm	MH20i	TP20	±(2.1+L/330)	2.3μm	1000kg	1620×1940×2760	1700
CMM-LE8106B		PH10T						
CMM-LE8106C		PH10M	SP25M	±(1.7+L/330)	1.7μm			
CMM-LE8126A	800×1200×600mm	MH20i	TP20	±(2.1+L/330)	2.3μm		1620×2140×2760	1900
CMM-LE8126B		PH10T						
CMM-LE8126C		PH10M	SP25M	±(1.7+L/330)	1.7μm			
CMM-LE8156A	800×1500×600mm	MH20i	TP20	±(2.1+L/330)	2.3μm	1620×2440×2760	2200	
CMM-LE8156B		PH10T						
CMM-LE8156C		PH10M	SP25M	±(1.7+L/330)	1.7μm			

MH20i SPECIFICATION

Angular movement with horizontal axis	0°~90° in 15 steps
Angular movement with vertical axis	±180° in 15 steps
Number of positions	168
Steering mode	manual
Max. extension length	75mm
Weight	210g

PH10T AND PH10M SPECIFICATION

Angular movement with horizontal axis	0°~105° in 7.5 steps
Angular movement with vertical axis	±180° in 7.5 steps
Number of positions	720
Steering mode	motorized
Max. output torque	0.45N.m
Max. extension length	300mm
Weight	649g

STYLI SET INCLUDED IN TP20

Type	Material	Ball diameter	Length	Stem diameter	Effective working length	Quantity
Styli	ruby ball/ stainless steel stem	SØ2.5mm	20mm	Ø1.4mm	14mm	4 pcs
		SØ4mm		Ø1.5mm	20mm	1 pc
		SØ3mm	10mm		7.5mm	1 pc

Type	Material	Diameter	Length	Quantity
Extension	stainless steel	Ø3mm	20mm	1 pc
			30mm	1 pc
Center base		7mm	7.5mm	1 pc

STYLI SET INCLUDED IN SP25M

Type	Material	Ball diameter	Length	Stem diameter	Effective working length	Quantity
Styli	ruby ball/ stainless steel stem	SØ1.5mm	21mm	Ø1mm	14mm	1 pc
		SØ2mm		Ø1.4mm	8mm	1 pc
		SØ3mm		Ø1.5mm	12mm	4 pcs
		SØ4mm		Ø2.5mm	27mm	1 pc
	ruby ball/ carbon fiber stem	SØ5mm	50mm	Ø3mm	42.5mm	1 pc
		SØ6mm	75mm	Ø4mm	75mm	1 pc

Type	Material	Diameter	Length	Quantity
Extension	stainless steel	Ø5mm	10mm	1 pc
		Ø4mm	20mm	1 pc
Center base		10mm	13mm	1 pc

MEASURING ARMS



- In accordance with ISO 10360-12
- Internal balance
- Dual high performance batteries
- Equivalent-arm design
- High-speed WiFi performance
- Aerospace grade carbon-fiber material
- Automatic power off
- U-shaped anti-collision design of the base



CMM-CM30

STANDARD PRECISION, BE SERIES, 6-AXIS

(mm)

Code	Measuring range	Maximum permissible error				
		SPAT	E _{UNI}	P _{SIZE}	P _{FORM}	L _{DIA}
CMM-BE15	1500	0.028	0.036	0.015	0.029	0.038
CMM-BE20	2000	0.030	0.040	0.018	0.035	0.041
CMM-BE25	2500	0.035	0.045	0.020	0.038	0.050
CMM-BE30	3000	0.055	0.065	0.028	0.045	0.080
CMM-BE35	3500	0.075	0.080	0.035	0.058	0.098
CMM-BE40	4000	0.090	0.100	0.044	0.068	0.116
CMM-BE45	4500	0.112	0.120	0.048	0.086	0.128

HIGH PRECISION, CM SERIES, 6-AXIS

(mm)

Code	Measuring range	Maximum permissible error				
		SPAT	E _{UNI}	P _{SIZE}	P _{FORM}	L _{DIA}
CMM-CM15	1500	0.018	0.025	0.009	0.016	0.026
CMM-CM20	2000	0.020	0.028	0.010	0.018	0.032
CMM-CM25	2500	0.023	0.030	0.012	0.022	0.038
CMM-CM30	3000	0.034	0.042	0.016	0.032	0.052
CMM-CM35	3500	0.043	0.056	0.020	0.038	0.066
CMM-CM40	4000	0.052	0.066	0.024	0.044	0.083
CMM-CM45	4500	0.061	0.089	0.038	0.078	0.108

HIGH PRECISION, CM SERIES, 7-AXIS

(mm)

Code	Measuring range	Maximum permissible error				
		SPAT	E _{UNI}	P _{SIZE}	P _{FORM}	L _{DIA}
CMM-CM20S	2000	0.022	0.030	0.012	0.022	0.040
CMM-CM25S	2500	0.027	0.032	0.013	0.025	0.048
CMM-CM30S	3000	0.042	0.053	0.020	0.035	0.078
CMM-CM35S	3500	0.055	0.066	0.024	0.043	0.092
CMM-CM40S	4000	0.065	0.082	0.029	0.048	0.102
CMM-CM45S	4500	0.073	0.099	0.043	0.082	0.132

To be continued

Continued from previous page

ULTRA HIGH PRECISE, HP SERIES, 6-AXIS

(mm)

Code	Measuring range	Maximum permissible error				
		SPAT	E _{UNI}	P _{SIZE}	P _{FORM}	L _{DIA}
CMM-HP15	1500	0.012	0.022	0.007	0.012	0.024
CMM-HP20	2000	0.016	0.024	0.008	0.015	0.030
CMM-HP25	2500	0.018	0.026	0.009	0.018	0.032
CMM-HP30	3000	0.026	0.038	0.012	0.025	0.045
CMM-HP35	3500	0.036	0.052	0.016	0.034	0.060
CMM-HP40	4000	0.045	0.063	0.020	0.038	0.077
CMM-HP45	4500	0.055	0.080	0.028	0.050	0.101

ULTRA HIGH PRECISE, HP SERIES, 7-AXIS

(mm)

Code	Measuring range	Maximum permissible error				
		SPAT	E _{UNI}	P _{SIZE}	P _{FORM}	L _{DIA}
CMM-HP20S	2000	0.018	0.026	0.010	0.019	0.038
CMM-HP25S	2500	0.020	0.028	0.011	0.022	0.042
CMM-HP30S	3000	0.032	0.048	0.016	0.032	0.072
CMM-HP35S	3500	0.045	0.061	0.020	0.039	0.088
CMM-HP40S	4000	0.055	0.076	0.026	0.044	0.098
CMM-HP45S	4500	0.065	0.095	0.036	0.065	0.122



Single-point articulation test



Distance measurement error between two points



Sphere form measurement error



Sphere size measurement error



Sphere diameter obtained from performing the articulated location test (diameter of the spherical zone containing the centers of a sphere measured from multiple orientations)

SPECIFICATION

Temperature rate	3°C/5min
Battery life	5h for one battery; 10h for two batteries
Output	USB, WIFI
Operation temperature	5°C~45°C
Operation humidity	0~95%, non-condensing
Power supply	100~240VAC, 50/60Hz
Weight	8.8kg~10.6kg

STANDARD DELIVERY

Main unit	1 pc
3mm zircon ball probe	1 pc
6mm zircon ball probe	1 pc
Calibration cone	1 pc
Lithium batteries	2 pcs
USB cable	1 pc
Power adapter	1 pc
Dust cover	1 pc



3mm zircon ball probe (included)



6mm zircon ball probe (included)



calibration cone (included)

To be continued

Continued from previous page



laser line probe
(optional)



electric vacuum base
(optional)



DELL laptop
(optional)

LASER LINE PROBE SPECIFICATION

Code	CMM-CEM-SD	CMM-CEM-HD
Accuracy	±28µm (2σ)	±15µm (2σ)
Working distance	115mm	
Effective scan width	near field 80mm, far field 150mm	
Points per line	maximum 4000 points per line	
Scan rate	1200000 points per second	
Laser	class 2	
Weight	536g	

SYSTEM ACCURACY WITH LASER LINE PROBE

Code	CMM-CEM-SD	CMM-CEM-HD
CMM-CM20S	0.050mm	0.040mm
CMM-CM25S	0.055mm	0.045mm
CMM-CM30S	0.062mm	0.052mm
CMM-CM35S	0.076mm	0.065mm
CMM-CM40S	0.090mm	0.081mm
CMM-CM45S	0.139mm	0.131mm
CMM-HP20S	0.043mm	0.038mm
CMM-HP25S	0.048mm	0.042mm
CMM-HP30S	0.055mm	0.047mm
CMM-HP35S	0.068mm	0.060mm
CMM-HP40S	0.080mm	0.074mm
CMM-HP45S	0.125mm	0.120mm



magnetic base
(optional)

OPTIONAL ACCESSORY

DELL laptop	CMM-CEM-PCE
Polyworks software	CMM-CEM-PW
Adjustable tripod	CMM-CEM-FAT
Electric vacuum base	CMM-CEM-EVCP
Magnetic base	CMM-CEM-IMM
Magnetic cones	CMM-CEM-MC
Magnetic spheres	CMM-CEM-MS
Point probe	CMM-CEM-PP
2mm ruby ball probe	CMM-CEM-RP2
5mm zircon ball probe	CMM-CEM-ZP5
10mm zircon ball probe	CMM-CEM-ZP10
3" straight probe extension	CMM-CEM-SPE3
4" straight probe extension	CMM-CEM-SPE4
60° probe adapter	CMM-CEM-DP60
90° probe adapter	CMM-CEM-DP90
3mm extended ball probe	CMM-CEM-EPB3
6mm extended ball probe	CMM-CEM-EPB6
Probe adapter	CMM-CEM-PA
High accuracy laser line probe	CMM-CEM-HD*
Standard accuracy laser line probe	CMM-CEM-SD*



adjustable tripod (optional)

*Laser line probes are suitable for 7-axis measuring arms only

STYLI FOR CMM

- Roundness: 0.25µm



ISQ-20-071

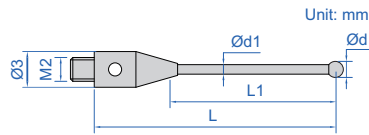

ISQ-25-125

M2 styli

(mm)

Code	Ød	Ød1	L	L1*	Material of rod	Material of tip
ISQ-20-002	1	0.7	10	4.5	stainless steel	ruby
ISQ-20-006	2	1	10	6		
ISQ-20-010	3	1.5	10	10		
ISQ-20-021	2	1.4	20	14		
ISQ-20-025	3	1.5	20	17.5		
ISQ-20-027	4	2	20	20	carbide	
ISQ-20-052	0.5	0.3	10	3		
ISQ-20-071	1	0.7	20	12.5		
ISQ-20-105	2	1.5	30	22.5	ceramic	
ISQ-20-120	3	2	30	27.5	carbon fibre	
ISQ-20-201	4	3	50	50		

*L1 is the effective working length, which is the distance from the center of the tip to the section of the stem with the same diameter as the tip



ISQ-30-066

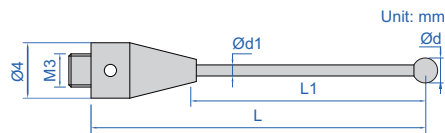

ISQ-35-110

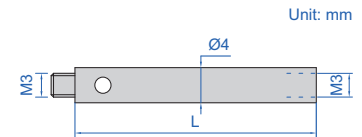

M3 styli

(mm)

Code	Ød	Ød1	L	L1*	Material of rod	Material of tip
ISQ-30-001	1	0.7	21	4	carbide	ruby
ISQ-30-003	2	1	21	8		
ISQ-30-005	3	1.5	21	12		
ISQ-30-031	2	1.5	30	22.5		
ISQ-30-066	3	2	50	42.5	ceramic	
ISQ-30-080	6	4	75	75	carbon fibre	

*L1 is the effective working length, which is the distance from the center of the tip to the section of the stem with the same diameter as the tip

M3 extension rods of styli

(mm)

Code	L	Material
ISQ-35-101	10	stainless steel
ISQ-35-105	20	
ISQ-35-110	35	ceramic
ISQ-35-115	50	

M4 styli

(mm)

Code	Ød	Ød1	L	L1*	Material of rod	Material of tip
ISQ-40-113	3	2	18.5	13	stainless steel	ruby
ISQ-40-208	6	4	50	36		
ISQ-40-106	1	0.7	19.5	4	carbide	
ISQ-40-109	2	1.4	19	8		
ISQ-40-141	1	0.7	20	10		
ISQ-40-195	2	1.5	50	40		
ISQ-40-202	4	2	50	38	ceramic	
ISQ-40-173	5	4	50	34		
ISQ-40-179	6	4	50	36		
ISQ-40-222	6	4	75	63		
ISQ-40-240	5	4	100	84		
ISQ-40-245	6	4	100	86		

*L1 is the effective working length, which is the distance from the center of the tip to the section of the stem with the same diameter as the tip



ISQ-40-195

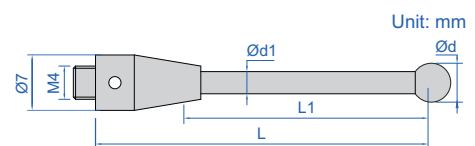

Unit: mm

To be continued

Continued from previous page



ISQ-45-025

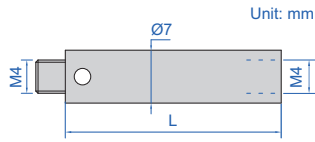

M4 extension rods of styli (mm)

Code	L	Material
ISQ-45-025	30	ceramic
ISQ-45-028	50	



ISQ-50-059

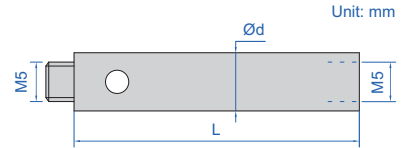
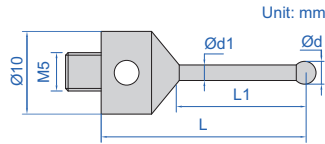

M5 styli (mm)

Code	Ød	Ød1	L	L1*	Material of rod	Material of tip
ISQ-50-051	1	0.7	20	5	carbide	ruby
ISQ-50-059	2	1.5	20	11		
ISQ-50-067	3	2	20	11		
ISQ-50-071	4	2	20	11		
ISQ-50-075	5	3	20	11		

* L1 is the effective working length, which is the distance from the center of the tip to the section of the stem with the same diameter as the tip

M5 extension rods of styli (mm)

Code	L	Ød	Material
ISQ-55-012	20	10	stainless steel
ISQ-55-014	30	10	
ISQ-55-016	50	10	
ISQ-55-018	100	10	
ISQ-55-031	50	20	aluminum
ISQ-55-035	100	20	
ISQ-55-039	200	20	

STANDARD BALLS FOR CMM

INSIZE PLUS
MADE IN EUROPE



- Diameter accuracy of ceramic ball: +1.25µm/-1µm, roundness: 0.13µm
- Mirror surface
- Stainless steel measuring rod
- Supplied with manufacturer inspection certificate



ISQ-16-025CE-M8

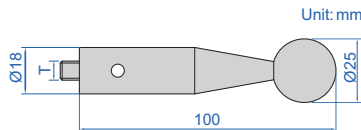

ISQ-16-BASE-M8

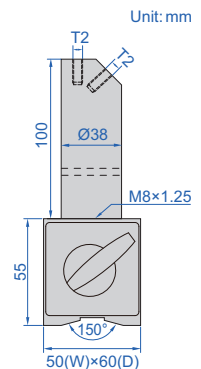

Code	T	Remark
ISQ-16-025CE-M6	M6	including measuring rod
ISQ-16-025CE-M8	M8	
ISQ-16-025CE-M10	M10	
ISQ-16-025CE-M12	M12	

Code	T2	Magnetic force
ISQ-16-BASE-M6	M6	80kgf
ISQ-16-BASE-M8	M8	80kgf
ISQ-16-BASE-M10	M10	80kgf
ISQ-16-BASE-M12	M12	80kgf



- To calibrate CMM probes
- Zirconia material, high strength and hardness, extremely wear resistance and corrosion resistance
- good insulation, antistatic and magnetic resistance
- Mirror surface, with pole
- Supplied with manufacturer inspection certificate

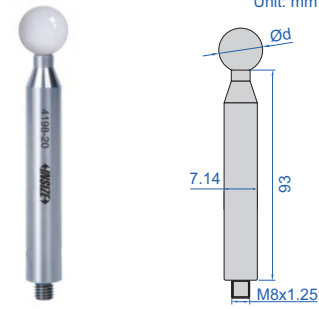

4198-20

CERAMIC BALL GAUGES

High accuracy

Code	Diameter (Ød)	Accuracy	Roundness
4198-8	8mm	±5µm	0.5µm
4198-10	10mm	±5µm	0.5µm
4198-12D7	12.7mm	±5µm	0.5µm
4198-13	13mm	±5µm	0.5µm
4198-14	14mm	±5µm	0.5µm
4198-15	15mm	±5µm	0.5µm
4198-16	16mm	±5µm	0.5µm
4198-17	17mm	±5µm	0.5µm
4198-20	20mm	±5µm	0.5µm
4198-25D4	25.4mm	±5µm	0.5µm

Standard accuracy

Code	Diameter (Ød)	Accuracy	Roundness
4198-8A	8mm	±5µm	1µm
4198-10A	10mm	±5µm	1µm
4198-12D7A	12.7mm	±5µm	1µm
4198-13A	13mm	±5µm	1µm
4198-14A	14mm	±5µm	1µm
4198-15A	15mm	±5µm	1µm
4198-16A	16mm	±5µm	1µm
4198-17A	17mm	±5µm	1µm
4198-20A	20mm	±5µm	1µm
4198-25D4A	25.4mm	±5µm	1µm



6885-1000

- Made of aluminum
- Used with gauge blocks to calibrate CMM
- Optional accessory: gauge blocks (4101, 4103 and 4104 series)

Code	Length (L)	Height (H)
6885-1000	500, 600, 650, 700, 750, 800, 850, 900, 1000	235, 355, 475

GAUGE BLOCK STAND FOR CMM

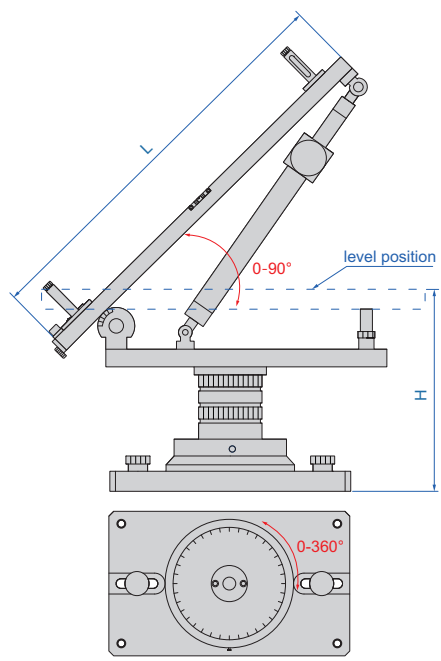

height column (included, 2pcs)



extension plate (included, 4pcs)

CMM CHECK MASTERS



horizontal use



6882-600A

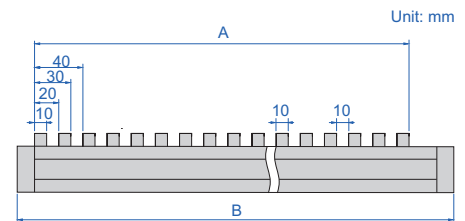

- To check the accuracy of table movements of machine tools and calibrate CMM, digital height gauge, height gauge, caliper
- Horizontal use and vertical use
- Constructed with ceramic gauge blocks
- Can be used with stand

STANDARD ACCURACY

Code	Size	Step	A (mm)	B (mm)	Range of inside measurement (mm)	Range of outside measurement (mm)	Range of height measurement (mm)
6882-300A*	0-300mm	10mm	310	350	10, 30, 50, 70, 90, 110, 130, 150, 170, 190, 210, 230, 250, 270, 290	10, 30, 50, 70, 90, 110, 130, 150, 170, 190, 210, 230, 250, 270, 290, 310	30, 50, 70, 90, 110, 130, 150, 170, 190, 210, 230, 250, 270, 290, 310, 330
6882-400A*	0-400mm	10mm	410	450	10, 30, 50, 70, 90, 110, 130, 150, 170, 190, 210, 230, 250, 270, 290, 310, 330, 350, 370, 390	10, 30, 50, 70, 90, 110, 130, 150, 170, 190, 210, 230, 250, 270, 290, 310, 330, 350, 370, 390, 410	30, 50, 70, 90, 110, 130, 150, 170, 190, 210, 230, 250, 270, 290, 310, 330, 350, 370, 390, 410, 430
6882-500A*	0-500mm	10mm	510	550	10, 30, 50, 70, 90, 110, 130, 150, 170, 190, 210, 230, 250, 270, 290, 310, 330, 350, 370, 390, 410, 430, 450, 470, 490	10, 30, 50, 70, 90, 110, 130, 150, 170, 190, 210, 230, 250, 270, 290, 310, 330, 350, 370, 390, 410, 430, 450, 470, 490, 510	30, 50, 70, 90, 110, 130, 150, 170, 190, 210, 230, 250, 270, 290, 310, 330, 350, 370, 390, 410, 430, 450, 470, 490, 510, 530
6882-600A*	0-600mm	10mm	610	650	10, 30, 50, 70, 90, 110, 130, 150, 170, 190, 210, 230, 250, 270, 290, 310, 330, 350, 370, 390, 410, 430, 450, 470, 490, 510, 530, 550, 570, 590	10, 30, 50, 70, 90, 110, 130, 150, 170, 190, 210, 230, 250, 270, 290, 310, 330, 350, 370, 390, 410, 430, 450, 470, 490, 510, 530, 550, 570, 590, 610	30, 50, 70, 90, 110, 130, 150, 170, 190, 210, 230, 250, 270, 290, 310, 330, 350, 370, 390, 410, 430, 450, 470, 490, 510, 530, 550, 570, 590, 610, 630
6882-1000A*	0-1000mm	10mm	1010	1050	10, 30, 50, 70, 90, 110, 130, 150, 170, 190, 210, 230, 250, 270, 290, 310, 330, 350, 370, 390, 410, 430, 450, 470, 490, 510, 530, 550, 570, 590, 610, 630, 650, 670, 690, 710, 730, 750, 770, 790, 810, 830, 850, 870, 890, 910, 930, 950, 970, 990	10, 30, 50, 70, 90, 110, 130, 150, 170, 190, 210, 230, 250, 270, 290, 310, 330, 350, 370, 390, 410, 430, 450, 470, 490, 510, 530, 550, 570, 590, 610, 630, 650, 670, 690, 710, 730, 750, 770, 790, 810, 830, 850, 870, 890, 910, 930, 950, 970, 990, 1010	30, 50, 70, 90, 110, 130, 150, 170, 190, 210, 230, 250, 270, 290, 310, 330, 350, 370, 390, 410, 430, 450, 470, 490, 510, 530, 550, 570, 590, 610, 630, 650, 670, 690, 710, 730, 750, 770, 790, 810, 830, 850, 870, 890, 910, 930, 950, 970, 990, 1010, 1030

To be continued

Continued from previous page

HIGH ACCURACY

Code	Size	Step	A (mm)	B (mm)	Range of inside measurement (mm)	Range of outside measurement (mm)	Range of height measurement (mm)
6882-300H*	0-300mm	10mm	310	350	10, 30, 50, 70, 90, 110, 130, 150, 170, 190, 210, 230, 250, 270, 290	10, 30, 50, 70, 90, 110, 130, 150, 170, 190, 210, 230, 250, 270, 290, 310	30, 50, 70, 90, 110, 130, 150, 170, 190, 210, 230, 250, 270, 290, 310, 330
6882-400H*	0-400mm	10mm	410	450	10, 30, 50, 70, 90, 110, 130, 150, 170, 190, 210, 230, 250, 270, 290, 310, 330, 350, 370, 390	10, 30, 50, 70, 90, 110, 130, 150, 170, 190, 210, 230, 250, 270, 290, 310, 330, 350, 370, 390, 410	30, 50, 70, 90, 110, 130, 150, 170, 190, 210, 230, 250, 270, 290, 310, 330, 350, 370, 390, 410, 430
6882-500H*	0-500mm	10mm	510	550	10, 30, 50, 70, 90, 110, 130, 150, 170, 190, 210, 230, 250, 270, 290, 310, 330, 350, 370, 390, 410, 430, 450, 470, 490	10, 30, 50, 70, 90, 110, 130, 150, 170, 190, 210, 230, 250, 270, 290, 310, 330, 350, 370, 390, 410, 430, 450, 470, 490, 510	30, 50, 70, 90, 110, 130, 150, 170, 190, 210, 230, 250, 270, 290, 310, 330, 350, 370, 390, 410, 430, 450, 470, 490, 510, 530
6882-600H*	0-600mm	10mm	610	650	10, 30, 50, 70, 90, 110, 130, 150, 170, 190, 210, 230, 250, 270, 290, 310, 330, 350, 370, 390, 410, 430, 450, 470, 490, 510, 530, 550, 570, 590	10, 30, 50, 70, 90, 110, 130, 150, 170, 190, 210, 230, 250, 270, 290, 310, 330, 350, 370, 390, 410, 430, 450, 470, 490, 510, 530, 550, 570, 590, 610	30, 50, 70, 90, 110, 130, 150, 170, 190, 210, 230, 250, 270, 290, 310, 330, 350, 370, 390, 410, 430, 450, 470, 490, 510, 530, 550, 570, 590, 610, 630
6882-1000H*	0-1000mm	10mm	1010	1050	10, 30, 50, 70, 90, 110, 130, 150, 170, 190, 210, 230, 250, 270, 290, 310, 330, 350, 370, 390, 410, 430, 450, 470, 490, 510, 530, 550, 570, 590, 610, 630, 650, 670, 690, 710, 730, 750, 770, 790, 810, 830, 850, 870, 890, 910, 930, 950, 970, 990	10, 30, 50, 70, 90, 110, 130, 150, 170, 190, 210, 230, 250, 270, 290, 310, 330, 350, 370, 390, 410, 430, 450, 470, 490, 510, 530, 550, 570, 590, 610, 630, 650, 670, 690, 710, 730, 750, 770, 790, 810, 830, 850, 870, 890, 910, 930, 950, 970, 990, 1010	30, 50, 70, 90, 110, 130, 150, 170, 190, 210, 230, 250, 270, 290, 310, 330, 350, 370, 390, 410, 430, 450, 470, 490, 510, 530, 550, 570, 590, 610, 630, 650, 670, 690, 710, 730, 750, 770, 790, 810, 830, 850, 870, 890, 910, 930, 950, 970, 990, 1010, 1030

*Supplied with manufacturer inspection certificate

Accuracy

Range (mm)	Standard accuracy	High accuracy
≤300	±1.3µm	±0.8µm
>300, ≤400	±1.6µm	±1.0µm
>400, ≤500	±2.0µm	±1.0µm
>500, ≤600	±2.5µm	±1.0µm
>600, ≤800	±3.0µm	±2.5µm
>800, ≤1000	±4.0µm	±2.5µm

Stand (optional)

Code	Applicable check masters
6882-S1	6882-300A, 6882-300H
6882-S2	6882-400A, 6882-400H
6882-S3	6882-500A, 6882-500H
6882-S4	6882-600A, 6882-600H
6882-S5	6882-1000A, 6882-1000H

can be used with stand (optional)



CMM CHECK MASTERS (ADVANCED TYPE)



6874-1000

- To check the accuracy of table movements of machine tools and calibrate CMM
- Horizontal use and vertical use
- Constructed with ceramic gauge blocks
- Can be used with stand

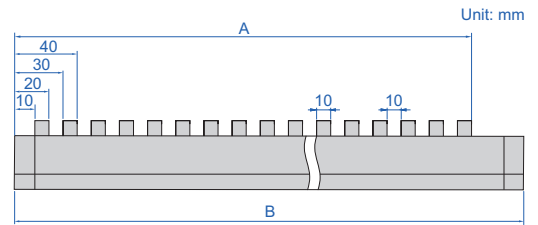

Code	Size	Step	A	B
6874-300 *	0-300mm	10mm	320mm	345mm
6874-450 *	0-450mm	10mm	470mm	495mm
6874-600 *	0-600mm	10mm	620mm	645mm
6874-1000 *	0-1000mm	10mm	1020mm	1045mm

* Supplied with ISO17025 calibration certificate of Shenzhen Institute of Metrology & Quality Inspection (SMQ)



ISO17025 calibration certificate

Accuracy

Range (mm)	Accuracy	Work face size variation
≤100	±1.0μm	0.5μm
>100, ≤200	±1.1μm	0.5μm
>200, ≤300	±1.3μm	0.6μm
>300, ≤400	±1.6μm	0.7μm
>400, ≤500	±2.0μm	0.8μm
>500, ≤600	±2.5μm	1.0μm
>600, ≤800	±3.0μm	1.4μm
>800, ≤1000	±4.0μm	1.8μm



can be used with stand (optional)

Stand (optional)

Code	Applicable check masters
6874-A	6874-300, 6874-450, 6874-600
6874-B	6874-1000



CAN BE
CUSTOMIZED

JIGS FOR CMM (ANVIL Ø2.5mm)

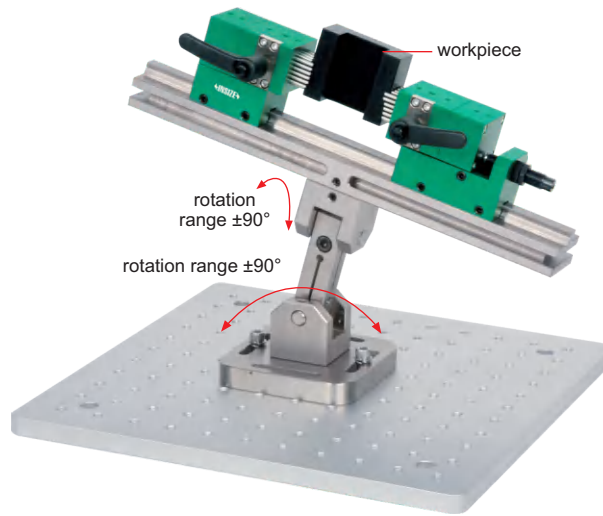

ISY-200

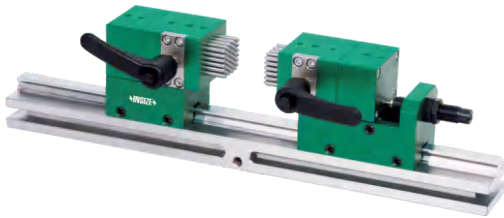

ISY-200-A



ISY-200-3



ISY-200-5

Code	Product	Remark
ISY-200	3-piece jig set	including 1 pc ISY-200-A, 1 pc ISY-200-3, 1 pc ISY-200-5

(mm)

Code	Product	Clamping range	Anvil area	Anvil stroke
ISY-200-A	jigs for cmm	0~170	20.5×23.3	12

(mm)

Code	Product	Size	Hole size
ISY-200-3	base plate	300×300×12	M6

(mm)

Code	Product	Size
ISY-200-5	two-way adjustable stand	95×95×134.5

JIGS FOR CMM (ANVIL Ø6mm)

CAN BE CUSTOMIZED

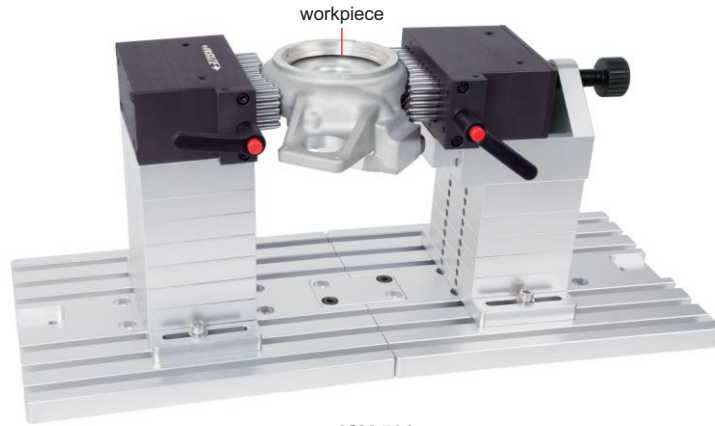

ISY-500



ISY-500-1



ISY-500-2



ISY-500-3



ISY-500-4



ISY-500-5



ISY-500-6



ISY-500-7

Code	Product	Remark
ISY-500	19-piece jig set	including 1 pc ISY-500-1, 1 pc ISY-500-2, 2 pcs ISY-500-3, 10 pcs ISY-500-4, 2 pcs ISY-500-5, 1 pc ISY-500-6, 2 pcs ISY-500-7

Code	Product	Size	Anvil area	Anvil stroke
ISY-500-1	spring anvil	134×90×90	36×100	24
ISY-500-2	adjustable spring anvil (range 0-40mm)	134×120×130	36×100	24

(mm)

Code	Product	Size
ISY-500-3	base plate	300×240×20
ISY-500-4	block	120×90×20
ISY-500-5	connecting plate	170×90×15
ISY-500-6	connecting block of base plate	80×50×10
ISY-500-7	clamp handle	—

(mm)



CAN BE CUSTOMIZED

JIGS FOR CMM (ANVIL Ø2.5mm)



ISY-300-1



ISY-300



ISY-300-2



ISY-300-3



ISY-300-4



ISY-300-5



ISY-300-6



ISY-300-7



ISY-300-8



ISY-300-9



ISY-300-10



ISY-300-11



ISY-300-12



ISY-300-13

Code	Product	Remark
ISY-300	46-piece jig set	including 1 pc ISY-300-1, 2 pcs ISY-300-2, 1 pc ISY-300-3, 2 pcs ISY-300-4, 14 pcs ISY-300-5, 2 pcs ISY-300-6, 8 pcs ISY-300-7, 6 pcs ISY-300-8, 2 pcs ISY-300-9, 2 pcs ISY-300-10, 2 pcs ISY-300-11, 2 pcs ISY-300-12, 2 pcs ISY-300-13

Code	Product	Size	Hole size
ISY-300-1	base plate	300×300×12mm	M8

Code	Product	Size	Anvil area	Anvil stroke
ISY-300-2	spring anvil	60×40×75	20.5×23	14
ISY-300-3	spring anvil	Ø26×73	3.1cm ² (hexagon)	14

Code	Product	Size (mm)
ISY-300-4	block	50×50×50
ISY-300-5	block	50×50×20
ISY-300-6	connecting plate	110×50×10
ISY-300-7	block	Ø26×20
ISY-300-8	block	Ø26×30
ISY-300-9	connecting plate	150×26×10
ISY-300-10	clip	65×11
ISY-300-11	clip	100×11
ISY-300-12	connecting block of clip stand	Ø26×20
ISY-300-13	clip stand	Ø8×75

JIGS FOR CMM (ANVIL Ø6mm)

CAN BE CUSTOMIZED

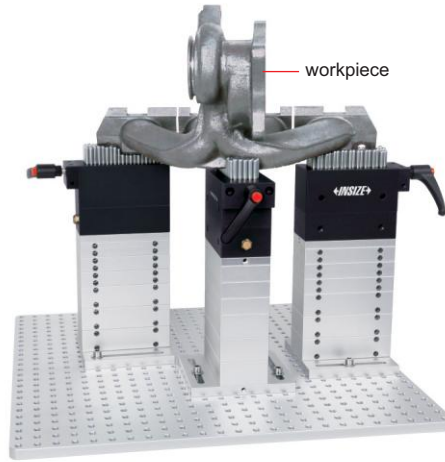

ISY-400



ISY-400-1



ISY-400-2



ISY-400-3



ISY-400-4



ISY-400-5



ISY-400-6

Code	Product	Remark
ISY-400	28-piece jig set	including 3 pcs ISY-400-1, 9 pcs ISY-400-2, 9 pcs ISY-400-3, 1 pc ISY-400-4, 3 pcs ISY-400-5, 3 pcs ISY-400-6

(mm)

Code	Product	Size
ISY-400-2	block	120×60×20
ISY-400-3	block	120×60×30
ISY-400-4	base plate	500×500×12
ISY-400-5	connecting plate	130×120×12
ISY-400-6	clamp handle	—

(mm)

Code	Product	Size	Anvil area	Anvil stroke
ISY-400-1	spring anvil	135×60×90	36×100	24





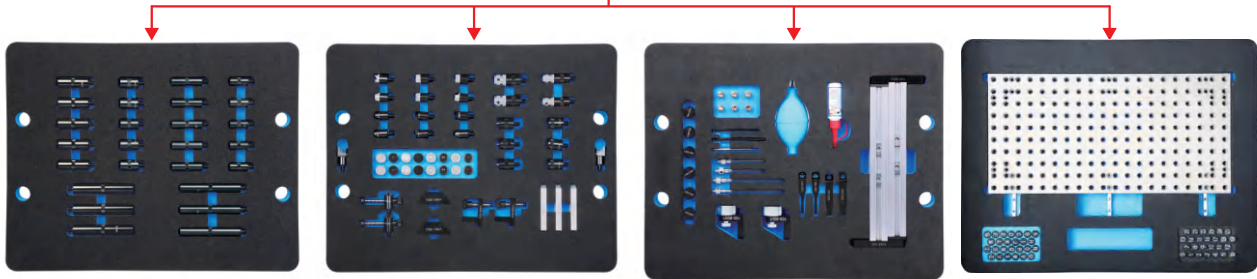



158-PIECE JIG SET FOR CMM CODE ISY-100

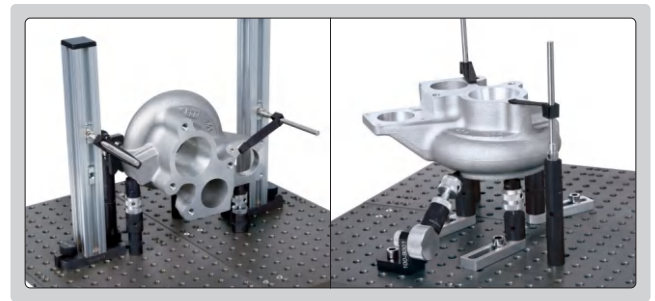

ISY-100

application examples



Product	Code	Size (mm)	Quantity	Application
	ISY-100-1001	Ø16×30	5	
	ISY-100-1002	Ø16×50	5	
	ISY-100-1003	Ø16×100	3	
	ISY-100-1004	Ø20×30	5	
	ISY-100-1005	Ø20×50	5	
	ISY-100-1006	Ø20×100	3	
stand with fine adjustment	ISY-100-2001	Ø16×45~60	2	height adjustment: 45~60mm
stand with fine adjustment	ISY-100-2003	Ø20×45~60	2	
horizontal spring stand	ISY-100-4001	—	2	

Product	Code	Size (mm)	Quantity	Application
horizontal screw stand	ISY-100-5001	—	2	
magnetic stand (magnetic top surface)	ISY-100-7001	Ø20×25	3	
stand for slice parts	ISY-100-8001	Ø20×25	2	ISY-100-8001 and ISY-100-8002 use cooperatively 
clamping stand for slice parts	ISY-100-8002		1	









To be continued

Continued from previous page

Product	Code	Size (mm)	Quantity	Application
clip 	ISY-100-1201	—	2	
clip 	ISY-100-1301	—	2	
clip stand 	ISY-100-1401	Ø6×60	2	
	ISY-100-1402	Ø6×100	2	
vertical square column 	ISY-100-3003	30×30×250	2	
sliding support plate 	ISY-100-1801	78×20×10	3	
clamping screw 	ISY-100-2301	Ø8×20	6	
screw 	ISY-100-2302	Ø8×20	6	
base plate 	ISY-600-400200	400×400×12 hole size: M8×1.25 hole center distance: 20	2 pieces	—
wrench 	ISY-100-3701	Ø3.8×70	1	—
wrench 	ISY-100-3801	M2.5	1	—
	ISY-100-3802	M5	1	—
	ISY-100-3803	M6	1	—
45° stand 	ISY-100-9001	—	2	
V shaped support 	ISY-100-1901	—	2	

Product	Code	Quantity	Application
V shaped support 	ISY-100-1902	2	
marker 	ISY-6100-1501	52*	
dust cleaner 	ISY-100-3501	1	—
lubricating oil 	ISY-100-3601	1	—

* Letter A-Z, number 0-25

Product	Code	Quantity	Material	Application
support head 	ISY-100-27016	2	aluminum	
	ISY-100-27018	2	nylon	
support head 	ISY-100-27026	2	aluminum	
	ISY-100-27028	2	nylon	
support head 	ISY-100-27036	2	aluminum	
	ISY-100-27038	2	nylon	
support head 	ISY-100-27046	2	aluminum	
	ISY-100-27048	2	nylon	
support head 	ISY-100-27056	2	aluminum	
	ISY-100-27058	2	nylon	
support head 	ISY-100-27066	2	aluminum	
	ISY-100-27068	2	nylon	
support head 	ISY-100-27076	2	aluminum	
	ISY-100-27078	2	nylon	



99-PIECE JIG SET FOR CMM CODE ISY-600



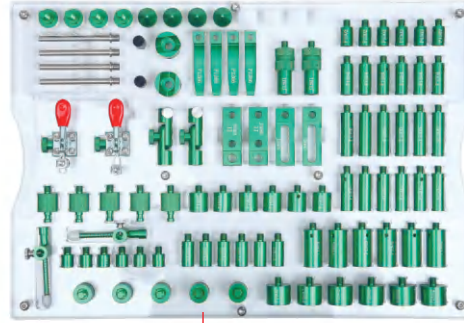



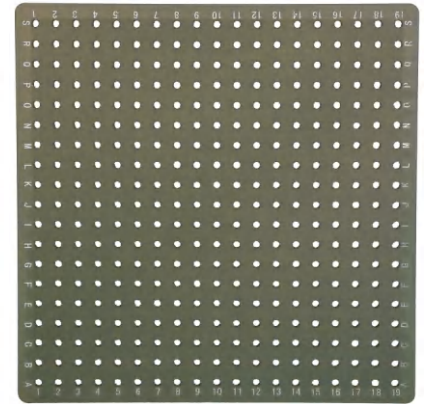



application example











acrylic tray (included)



ISY-600

Product	Code	Size (mm)	Quantity
 stand	ISY-600-P1301	Ø13×13	6
	ISY-600-P1302	Ø13×20	6
	ISY-600-P1303	Ø13×26	6
 stand	ISY-600-P1304	Ø13×32	6
	ISY-600-P1305	Ø13×40	6
	ISY-600-P1306	Ø13×45	6
 stand	ISY-600-P1902	Ø20×20	6
	ISY-600-P1905	Ø20×38	6
	ISY-600-P2602	Ø26×20	6
 spring stand	ISY-600-P1522	—	2
 universal support	ISY-600-J1560	—	2
 stand with fine adjustment	ISY-600-J1501	48~60	2
 magnetic stand (magnetic top surface)	ISY-600-J2020	Ø20×20	5
 adaptor	ISY-600-J2021	Ø20×19	5
 V shaped support	ISY-600-J2520	Ø25×20	2
 clamping screw	ISY-600-P2003	M8x1.25	4

Product	Code	Size (mm)	Quantity
 sliding support plate	ISY-600-J2060	60×20×10	2
 sliding support plate	ISY-600-J2060-2	60×20×10	2
 clip	ISY-600-P1266	12×66	4
 chuck support	ISY-600-JS201	—	2
 clip stand	ISY-600-P0684	Ø6×74	4
 aluminum support head	ISY-600-P2002	—	4
 nylon support head	ISY-600-P2001	—	4
 base plate	ISY-600-400	400×400×18 hole size: M8X1.25	1



Profile Projectors
Page 630-641



Quick Measurement Systems
Page 642-649



Horizontal Quick Measurement Systems
Page 650-651



2D+3D Composite CNC Vision Measuring Systems
Page 652-653



Horizontal Vision Measuring Systems
Page 654



Vision Measuring Systems
Page 655-670



Vision Measuring Softwares
Page 671-672

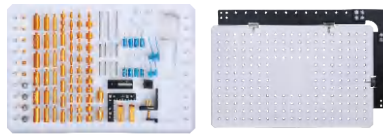

Jig Set For Vision Measuring Systems
Page 673



Standard Glass Scales
Page 674

PROFILE PROJECTORS



ISP-Z3015



edge detector

ISP-A1000E

digital readout of ISP-A1000E

- touch buttons
- USB data output to Excel and CAD
- show diagram







software flash disk (included, only for ISP-A1000E)

OPTIONAL ACCESSORY

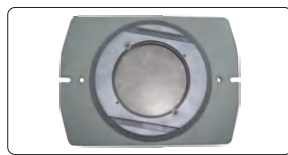

lens



rotary table (glass plate diameter 100mm)

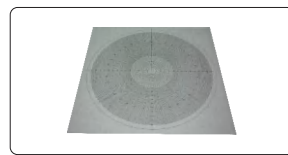

overlay chart (protractor with 1° graduation, radius with 1mm increment)



holder with clamp



swivel center support



V-block with clamp



50mm reading scale (check magnification accuracy)

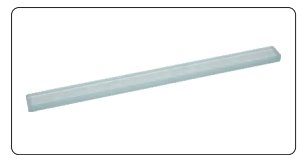

300mm calibration scale (check magnification accuracy together with 50mm reading scale or calibrate measuring accuracy)

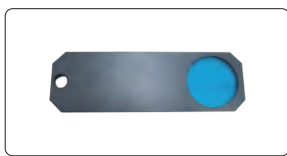

blue filter



demo sample

















printer (only for ISP-A1000E)

To be continued

Continued from previous page

SPECIFICATION

Code		ISP-Z3015		ISP-A1000E		
Edge detector		not included		included		
Lens	magnification	10X (included)	20X (optional)	50X (optional)	100X (optional)	
	view field	Ø30mm	Ø15mm	Ø6mm	Ø3mm	
	working distance	77.7mm	44.3mm	38.4mm	25.3mm	
Max. workpiece height		90mm	90mm	90mm	90mm	
Magnification accuracy		±0.08%				
Image		erect image				
Projector screen		diameter: Ø300mm rotation range: 0°~360°, resolution: 1" or 0.01° reference lines: cross-hairs				
Stage	metal stage size	340×152mm				
	glass stage size	196×96mm				
	X-Y stage travel	range: 150×50mm				
		resolution: 0.5µm				
	Z (focus) travel range	accuracy: (4+L/25)µm L is the measuring length in mm				
max. load capacity	90mm					
Illumination		contour illumination: 24V/150W halogen lamp, brightness is adjustable surface illumination: 24V/150W halogen lamp				
Data processing unit	display	X-Y stage travel, screen rotation				
	output	RS232C		RS232C, USB (data output to Excel and CAD)		
	function	 measure coordinate of point	 measure coordinate of line		 measure coordinate of point	
		 measure center coordinate, radius of circle with three points	 measure distance between two objects		 measure coordinate of line	
 measure angle with four points or two lines		 set origin of coordinate		 measure center coordinate, radius of circle with three points		
 coordinate transform		 measure distance between two objects		 measure angle with four points or two lines		
 set midpoint of coordinate		 coordinate transform		 choose measurement object automatically according to the selective point and display the result		
—		—		programming for batch measurements		
advanced function		—		programming for batch measurements		
Power supply		110/220V, 50/60Hz				
Dimension (L×W×H)	550×770×1100mm					
Weight	135kg					

STANDARD DELIVERY

Main unit	1 pc
10X lens with half-reflection mirror and oblique illuminator mirror	1 pc
Overlay chart clip	4 pcs
Foot-switch	1 pc
Anti-dust cover	1 pc
Software (only for ISP-A1000E) and USB cable	1 pc

OPTIONAL ACCESSORY

20X lens with half-reflection mirror and oblique illuminator mirror	ISP-Z3015-LENS20X
50X lens with half-reflection mirror	ISP-Z3015-LENS50X
100X lens with half-reflection mirror	ISP-Z3015-LENS100X
Rotary table	ISP-Z3015-TABLE
Overlay chart	ISP-Z3015-CHART
Holder with clamp	ISP-Z3015-HOLDER

Swivel center support	ISP-Z3015-SUPPORT
V-block with clamp	ISP-Z3015-VBLOCK
50mm reading scale	ISP-Z3015-SCALE50
300mm calibration scale	ISP-Z3015-RULE
Blue filter	ISP-Z3015-FILTER
Demo sample	ISP-Z3015-DEMO
Printer (only for ISP-A1000E)	ISP-A1000-PRINTER

THE STAGE DOESN'T
MOVE UP AND DOWN

**INSPECTION
CERTIFICATE**

HIGH PRECISION PROFILE PROJECTORS (WITH EDGE DETECTOR)



software flash disk
(included)



ISP-A5000E

digital readout



- Adjust the focus by ascending and descending the projector head, the stage doesn't move up and down
- Maximum workpiece weight 30kg

- touch buttons
- USB data output to Excel and CAD
- show diagram

OPTIONAL ACCESSORY



lens

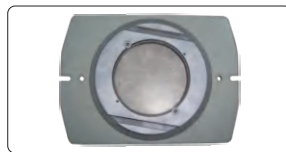

rotary table
(glass plate diameter 100mm)

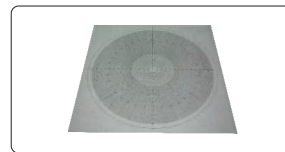

overlay chart (protractor with 1°
graduation, radius with 1mm increment)



holder with clamp



swivel center support



V-block with clamp



50mm reading scale
(check magnification accuracy)

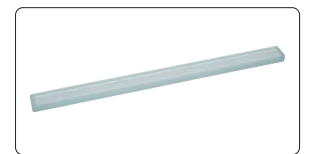

300mm calibration scale (check
magnification accuracy together
with 50mm reading scale or
calibrate measuring accuracy)



demo sample









printer

To be continued

Continued from previous page

SPECIFICATION

Code		ISP-A4500E	ISP-A5000E	ISP-A5001E	ISP-A5002E	ISP-A5003E
Edge detector		included				
Lens	magnification	10X (included)	20X (optional)	50X (optional)	100X (optional)	
	view field	Ø30mm	Ø15mm	Ø6mm	Ø3mm	
	working distance	77.7mm	44.3mm	38.4mm	25.3mm	
Max. workpiece height		90mm	90mm	90mm	90mm	
Magnification accuracy		±0.08%				
Image		erect image				
Projector screen		diameter: Ø300mm				
		rotation range: 0°~360°, resolution: 1" or 0.01°				
		reference lines: cross-hairs				
Stage	metal stage size	354×228mm	404×228mm	450×280mm	500×330mm	606×466mm
	glass stage size	210×160mm	260×160mm	306×196mm	321×221mm	450×350mm
	X-Y stage travel range	150×100mm	200×100mm	250×150mm	295×195mm	400×300mm
	resolution	0.5µm				
	accuracy	(3+L/75)µm L is the measuring length in mm				
	Z (focus) travel range	100mm				
	max. load capacity	30kg				
Illumination		contour illumination: 24V/150W halogen lamp, brightness is adjustable				
		surface illumination: 24V/150W halogen lamp				
Data processing unit	display	X-Y stage travel, screen rotation				
	output	RS232C, USB (data output to Excel and CAD)				
	function	 measure coordinate of point  measure coordinate of line  measure center coordinate, radius of circle with three points  measure distance between two objects  measure angle with four points or two lines  coordinate transform  choose measurement object automatically according to the selective point and display the result				
advanced function		programming for batch measurements				
Power supply		110/220V, 50/60Hz				
Dimension (L×W×H)		780×780×1100mm	780×780×1100mm	810×780×1120mm	900×780×1120mm	1040×780×1120mm
Weight		160kg	160kg	180kg	180kg	250kg

STANDARD DELIVERY

Main unit	1 pc
10X lens with half-reflection mirror and oblique illuminator mirror	1 pc
Overlay chart clip	4 pcs
Foot-switch	1 pc
Blue filter	1 pc
Anti-dust cover	1 pc

OPTIONAL ACCESSORY

20X lens with half-reflection mirror and oblique illuminator mirror	ISP-A5000-LENS20X
50X lens with half-reflection mirror	ISP-A5000-LENS50X
100X lens with half-reflection mirror	ISP-A5000-LENS100X
Rotary table (for ISP-A4500E/A5000E)	ISP-A5000-TABLE
Rotary table (for ISP-A5001E/A5002E)	ISP-A5001-TABLE
Rotary table (for ISP-A5003E)	ISP-A5003-TABLE
Printer	ISP-A5000-PRINTER

Swivel center support (for ISP-A4500E)	ISP-A4500-SUPPORT
Swivel center support (for ISP-A5000E/A5001E)	ISP-A5000-SUPPORT
Overlay chart	ISP-A5000-CHART
Holder with clamp	ISP-A5000-HOLDER
V-block with clamp	ISP-A5000-VBLOCK
50mm reading scale	ISP-A5000-SCALE50
300mm calibration scale	ISP-A5000-RULE
Demo sample	ISP-A5000-DEMO

THE STAGE DOESN'T
MOVE UP AND DOWN

**INSPECTION
CERTIFICATE**

HIGH PRECISION PROFILE PROJECTORS (WITHOUT EDGE DETECTOR)



ISP-AZ3020

- Adjust the focus by ascending and descending the projector head, the stage doesn't move up and down
- Maximum workpiece weight 30kg

OPTIONAL ACCESSORY



lens

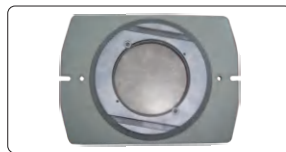

rotary table
(glass plate diameter 100mm)

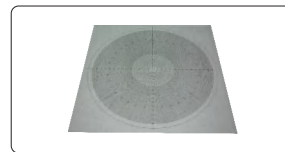

overlay chart (protractor with 1°
graduation, radius with 1mm increment)



holder with clamp



swivel center support



V-block with clamp



50mm reading scale
(check magnification accuracy)

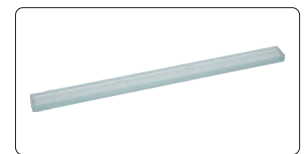

300mm calibration scale (check
magnification accuracy together
with 50mm reading scale or
calibrate measuring accuracy)











demo sample

To be continued

Continued from previous page

SPECIFICATION

Code		ISP-AZ3010	ISP-AZ3020	ISP-AZ3025	ISP-AZ3030	ISP-AZ3040
Edge detector		not included				
Lens	magnification	10X (included)	20X (optional)	50X (optional)	100X (optional)	
	view field	Ø30mm	Ø15mm	Ø6mm	Ø3mm	
	working distance	77.7mm	44.3mm	38.4mm	25.3mm	
Max. workpiece height		90mm	90mm	90mm	90mm	
Magnification accuracy		±0.08%				
Image		erect image				
Projector screen		diameter: Ø300mm				
		rotation range: 0°~360°, resolution: 1" or 0.01°				
		reference lines: cross-hairs				
Stage	metal stage size	354×228mm	404×228mm	450×280mm	500×330mm	606×466mm
	glass stage size	210×160mm	260×160mm	306×196mm	321×221mm	450×350mm
	X-Y stage travel range	150×100mm	200×100mm	250×150mm	295×195mm	400×300mm
	resolution	0.5µm				
	accuracy	(3+L/75)µm L is the measuring length in mm				
	Z (focus) travel range	100mm				
	max. load capacity	30kg				
Illumination		contour illumination: 24V/150W halogen lamp, brightness is adjustable				
		surface illumination: 24V/150W halogen lamp				
Data processing unit	display	X-Y stage travel, screen rotation				
	output	RS232C				
Data processing unit	function	 measure coordinate of point				
		 measure coordinate of line				
		 measure center coordinate, radius of circle with three points				
		 measure distance between two objects				
		 measure angle with four points or two lines				
		 set origin of coordinate				
		 coordinate transform				
		 set midpoint of coordinate				
Power supply		110/220V, 50/60Hz				
Dimension (L×W×H)		780×780×1100mm	780×780×1100mm	810×780×1120mm	900×780×1120mm	1040×780×1120mm
Weight		160kg	160kg	180kg	180kg	250kg

STANDARD DELIVERY

Main unit	1 pc
10X lens with half-reflection mirror and oblique illuminator mirror	1 pc
Overlay chart clip	4 pcs
Foot-switch	1 pc
Blue filter	1 pc
Anti-dust cover	1 pc

OPTIONAL ACCESSORY

20X lens with half-reflection mirror and oblique illuminator mirror	ISP-A5000-LENS20X
50X lens with half-reflection mirror	ISP-A5000-LENS50X
100X lens with half-reflection mirror	ISP-A5000-LENS100X
Rotary table (for ISP-AZ3010/3020)	ISP-A5000-TABLE
Rotary table (for ISP-AZ3025/3030)	ISP-A5001-TABLE
Rotary table (for ISP-AZ3040)	ISP-A5003-TABLE

Swivel center support (for ISP-AZ3010)	ISP-A4500-SUPPORT
Swivel center support (for ISP-AZ3020/3025)	ISP-A5000-SUPPORT
Overlay chart	ISP-A5000-CHART
Holder with clamp	ISP-A5000-HOLDER
V-block with clamp	ISP-A5000-VBLOCK
50mm reading scale	ISP-A5000-SCALE50
300mm calibration scale	ISP-A5000-RULE
Demo sample	ISP-A5000-DEMO

HORIZONTAL PROFILE PROJECTORS



**INSPECTION
CERTIFICATE**



ISP-W3020



ISP-A3000E

digital readout of ISP-A3000E

- touch buttons
- USB data output to Excel and CAD
- show diagram







software flash disk (included, only for ISP-A3000E)

OPTIONAL ACCESSORY

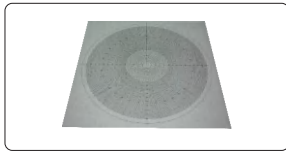

lens



overlay chart (protractor with 1° graduation, radius with 1mm increment)



50mm reading scale (check magnification accuracy)



demo sample

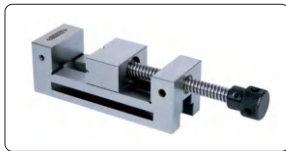

vise



rotary table

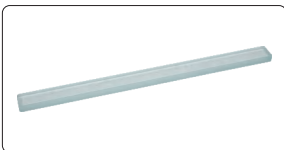















300mm calibration scale (check magnification accuracy together with 50mm reading scale or calibrate measuring accuracy)



printer (only for ISP-A3000E)

Continued from previous page

SPECIFICATION

Code		ISP-W3020	ISP-A3000E	
Edge detector		not included	included	
Lens	magnification	10X (included) 20X (optional)	50X (optional) 100X (optional)	
	view field	Ø30mm Ø15mm	Ø6mm Ø3mm	
	working distance	77.7mm 44.3mm	38.4mm 25.3mm	
Magnification accuracy		±0.08%		
Projector screen		diameter: Ø300mm		
		rotation range: 0°~360°, resolution: 1' or 0.01°		
		reference lines: cross-hairs		
Stage	metal stage size	400×150mm		
	turning range	±15°		
	X-Z stage travel	range: 200×100mm		
		resolution: 0.5µm		
	accuracy: (4+L/25)µm L is the measuring length in mm			
Y (focus) travel range	75mm			
max. load capacity		50kg		
Illumination		contour illumination: 24V/150W halogen lamp, brightness is adjustable		
		surface illumination: 12V/150W halogen lamp (with 2 fibers), position is adjustable		
Data processing unit	display	X-Z stage travel, screen rotation		
	output	RS232C	RS232C, USB (data output to Excel and CAD)	
	function	 measure coordinate of point	 measure coordinate of point	
		 measure coordinate of line	 measure coordinate of line	
 measure center coordinate, radius of circle with three points		 measure center coordinate, radius of circle with three points		
 measure distance between two objects		 measure distance between two objects		
 measure angle with four points or two lines		 measure angle with four points or two lines		
 set origin of coordinate		 coordinate transform		
 coordinate transform		 choose measurement object automatically according to the selective point and display the result		
 set midpoint of coordinate				
advanced function		—	programming for batch measurements	
Power supply		110/220V, 50/60Hz		
Dimension (L×W×H)		830×1090×1010mm		
Weight		160kg		

STANDARD DELIVERY

Main unit	1 pc
10X lens	1 pc
Overlay chart clip	4 pcs
Foot-switch	1 pc
Anti-dust cover	1 pc
Software (only for ISP-A3000E) and USB cable	1 pc

OPTIONAL ACCESSORY

20X lens	ISP-A3000-LENS20X
50X lens	ISP-A3000-LENS50X
100X lens	ISP-A3000-LENS100X
Overlay chart	ISP-A3000-CHART
50mm reading scale	ISP-A3000-SCALE50
300mm calibration scale	ISP-A3000-RULE

Demo sample	ISP-A3000-DEMO
V-block with clamp	ISP-A3000-VBLOCK
Rotary table	ISP-A3000-RTABLE
Vise	ISP-A3000-VISE
Printer (only for ISP-A3000E)	ISP-A3000-PRINTER



**INSPECTION
CERTIFICATE**

HORIZONTAL PROFILE PROJECTORS



ISP-W4025



ISP-A7000E

digital readout of ISP-A7000E

- touch buttons
- USB data output to Excel and CAD
- show diagram

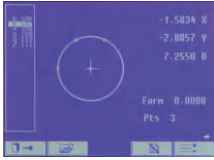
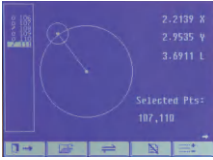

software flash disk (included, only for ISP-A7000E)

OPTIONAL ACCESSORY



lens

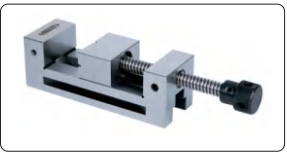

vise



rotary table



demo sample (need rotary table)



printer (only for ISP-A7000E)

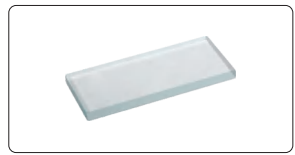

50mm reading scale (check magnification accuracy)

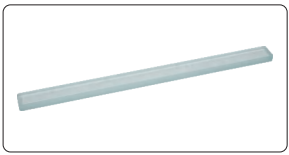

300mm calibration scale (check magnification accuracy together with 50mm reading scale or calibrate measuring accuracy)

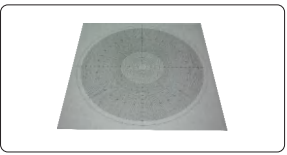

















Ø300mm overlay chart (protractor with 1° graduation, radius with 1mm increment)

To be continued

Continued from previous page

SPECIFICATION

Code		ISP-W4025			ISP-A7000E			
Edge detector		not included			included			
Lens	magnification	5X (optional)	10X (standard)	20X (optional)	50X (optional)	100X (optional)		
	view field	Ø80mm	Ø40mm	Ø20mm	Ø8mm	Ø4mm		
	working distance	93.7mm	103.9mm	95.1mm	65.7mm	35mm		
Magnification accuracy		±0.08%						
Image		erect image						
Projector screen		diameter: Ø400mm						
		rotation range: 0°~360°, resolution: 1' or 0.01°						
		reference lines: cross-hairs						
Stage	metal stage size	450×200mm						
	turning range	±15°						
	X-Z stage travel	range: 250×150mm						
		resolution: 0.5µm						
	Y (focus) travel range	accuracy: (4+L/25)µm L is the measuring length in mm						
max. load capacity	100mm							
max. load capacity		50kg						
Illumination		contour illumination: 24V/150W halogen lamp, brightness is adjustable						
		surface illumination: 12V/150W halogen lamp (with 2 fibers), position is adjustable						
Data processing unit	display	X-Z stage travel, screen rotation						
	output	RS232C			RS232C, USB (data output to Excel and CAD)			
	function		measure coordinate of point					measure coordinate of point
			measure coordinate of line					measure coordinate of line
		measure center coordinate, radius of circle with three points					measure center coordinate, radius of circle with three points	
		measure distance between two objects					measure distance between two objects	
		measure angle with four points or two lines					measure angle with four points or two lines	
		set origin of coordinate					coordinate transform	
		coordinate transform					coordinate transform	
		set midpoint of coordinate					choose measurement object automatically according to the selective point and display the result	
advanced function		—			programming for batch measurements			
Power supply		110/220V, 50/60Hz						
Dimension (L×W×H)		646×1215×1210mm						
Weight		240kg						

STANDARD DELIVERY

Main unit	1 pc
10X lens	1 pc
Overlay chart clip	4 pcs
Foot-switch	1 pc
Anti-dust cover	1 pc
Software (only for ISP-A7000E) and USB cable	1 pc

OPTIONAL ACCESSORY

5X lens	ISP-W4025-LENS5X
20X lens	ISP-W4025-LENS20X
50X lens	ISP-W4025-LENS50X
100X lens	ISP-W4025-LENS100X
Ø300mm overlay chart	ISP-A3000-CHART
50mm reading scale	ISP-A3000-SCALE50

300mm calibration scale	ISP-A3000-RULE
Demo sample	ISP-A3000-DEMO
V-block with clamp	ISP-A3000-VBLOCK
Rotary table	ISP-A3000-RTABLE
Vise	ISP-A3000-UISE
Printer (only for ISP-A7000E)	ISP-A3000-PRINTER



INSPECTION
CERTIFICATE

PROFILE PROJECTORS

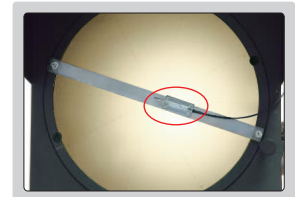

edge detector (for ISP-A6000E)

digital readout

- touch buttons
- USB data output to Excel and CAD
- show diagram

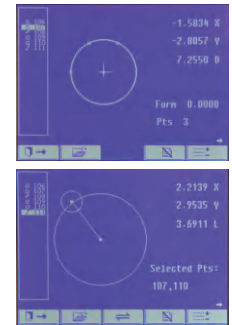

software flash disk (included)

ISP-A6000 (without edge detector)

OPTIONAL ACCESSORY



lens



rotary table
(glass plate diameter 100mm)



holder with clamp



printer

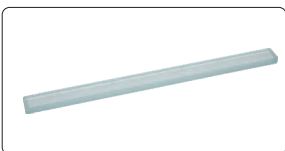

300mm calibration scale (check magnification accuracy together with 50mm reading scale or calibrate measuring accuracy)









50mm reading scale
(check magnification accuracy)



demo sample

Continued from previous page

SPECIFICATION

Code		ISP-A6000	ISP-A6000E			
Edge detector		not included	included			
Projector screen		diameter: Ø600mm				
		rotation range: 0°~360°, resolution: 1' or 0.01°				
		reference lines: cross-hairs				
Lens	magnification	5X (optional)	10X (included)	20X (optional)	50X (optional)	100X (optional)
	view field	Ø120mm	Ø60mm	Ø30mm	Ø12mm	Ø6mm
	working distance	242.8mm	143.2mm	85.5mm	92mm	48.5mm
Magnification accuracy		±0.08%				
Image		erect image				
Stage	metal stage size	404×265mm				
	glass stage size	270×170mm				
	X-Y stage travel	range: 200×100mm				
		resolution: 0.5µm				
	Z (focus) travel range	accuracy: (3+L/50)µm L is the measuring length in mm				
max. load capacity	50mm					
Illumination		contour illumination: 24V/150W halogen lamp, brightness is adjustable				
		surface illumination: 12V/150W halogen lamp (with 2 fibers), position is adjustable				
Data processing unit	display	X-Y stage travel, screen rotation				
	output	RS232C, USB (data output to Excel and CAD)				
	function		measure coordinate of point			
			measure coordinate of line			
		measure center coordinate, radius of circle with three points				
		measure distance between two objects				
		measure angle with four points or two lines				
		coordinate transform				
	choose measurement object automatically according to the selective point and display the result					
advanced function	programming for batch measurements					
Power supply		110/220V, 50/60Hz				
Dimension (L×W×H)		1200×1140×1940mm				
Weight		360kg				

STANDARD DELIVERY

Main unit	1 pc
10X lens	1 pc
Foot-switch	1 pc
Software and USB cable	1 pc
Overlay chart clip	4 pcs
Anti-dust cover	1 pc

OPTIONAL ACCESSORY

5X lens	ISP-A6000-LENS5X
20X lens	ISP-A6000-LENS20X
50X lens	ISP-A6000-LENS50X
100X lens	ISP-A6000-LENS100X
Holder with clamp	ISP-A6000-HOLDER

300mm calibration scale	ISP-A6000-RULE
50mm reading scale	ISP-A6000-SCALE50
Rotary table	ISP-A6000-TABLE
Demo sample	ISP-A6000-DEMO
Printer	ISP-A6000-PRINTER



LARGE SIZE QUICK MEASUREMENT SYSTEM CODE QMS-A450



SPECIFICATION

Optical lens		dual-field dual-telecentric low-distortion lens	
Measurement range		wide view field 500×400mm	small view field 430×350mm
Measurement Accuracy *	without stitching	±3μm ^①	±1μm ^②
	with stitching	±(5+0.02L)μm ^③	±(3+0.02L)μm ^④
Repeatability	without stitching	±1μm	±0.5μm
	with stitching	±2μm	±1.5μm
Illumination system	transmission light	telecentric illuminator, green light	
	surface light	vertical illuminator, high angle ring white light vertical illuminator, 4-zone low and medium angle ring white light (electric) vertical illuminator, circular (directional) green light (electric)	
	coaxial light (optional)	vertical illuminator, white light	
Max. weight of workpiece		25kg	
Measurement time		<2s	
Measurement data		2D measurement	
Environmental requirement		temperature: 20°C±2°C, relative humidity: 30%~80%, vibration: <0.002g, less than 15Hz	
Power supply		220V, 50Hz, 1200W	
Dimension (L×W×H)		1060×860×1890mm	
Weight		650kg	

* The optimum temperature is 20°C±1°C

- ① Within 73×49mm, on focal position and environment temperature at 20°C±1°C
- ② Within 16×12mm, on focal position and environment temperature at 20°C±1°C
- ③ Within 450×360mm, on focal position and environment temperature at 20°C±1°C
- ④ Within 387×315mm, on focal position and environment temperature at 20°C±1°C

Continued from previous page

- One or more workpieces can be measured by one step operation
- Place workpieces at any position
- Focus and measure automatically
- Measurement of 999+ dimensions and 200+ workpieces
- Suitable for parts with high precision requirements for large, medium, and small sizes

STANDARD DELIVERY

Main unit	1 pc
Computer	1 pc
Software	1 pc

OPTIONAL ACCESSORY

Coaxial light illumination	QMS-43-A1
Data transmission function of software	QMS-23-D1
CAD import function of software	QMS-23-C1
Laser sensor	QMS-43-SJ1
Foot-switch	QMS-43-FS1

Software (included)

- Automatically measure widths, holes, rings, angles at the same time, simple and efficient

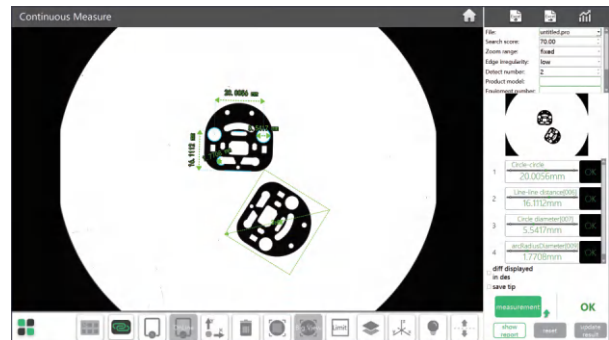
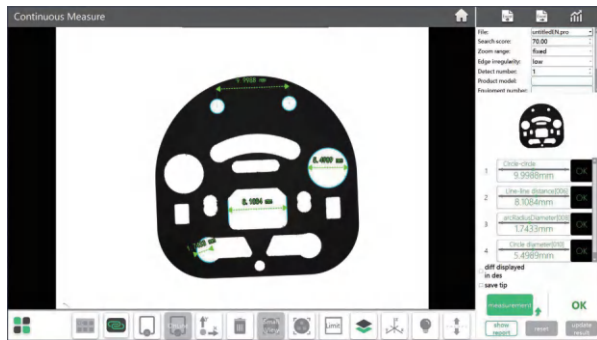

- Measuring result can be stored automatically. OK items and NG items can be counted automatically



SMALL VIEW FIELD SUITABLE FOR MEASURING
SMALL SIZES SUCH AS THREADS AND CHAMFERS

HIGH PRECISION QUICK MEASUREMENT SYSTEM CODE QMS-H210



SPECIFICATION

Optical lens		dual-field dual-telecentric low-distortion lens	
Measurement range		wide view field 210×130mm	small view field 200×100mm
Measurement Accuracy	without stitching	±2μm ^①	±0.7μm ^②
	with stitching	±(4+0.02L)μm ^③	±(2.7+0.02L)μm ^④
Repeatability	without stitching	±1μm	±0.25μm
	with stitching	±2μm	±1.25μm
Illumination system	transmission light	telecentric illuminator, green light	
	surface light	vertical illuminator, high angle ring white light vertical illuminator, 4-zone low and medium angle ring white light (electric) vertical illuminator, circular (directional) green light (electric)	
	coaxial light	vertical illuminator, white light	
Max. weight of workpiece		5kg	
Measurement time		<2s	
Measurement data		2D measurement	
Environmental requirement		temperature: 20°C±2°C, relative humidity: 30%~80%, vibration: <0.002g, less than 15Hz	
Power supply		220V, 50Hz, 600W	
Dimension (L×W×H)		460×515×740mm	
Weight		45kg	

* The optimum temperature is 20°C±1°C

① Within 20×20mm, on focal position and environment temperature at 20°C±1°C

② Within 8×5mm, on focal position and environment temperature at 20°C±1°C

③ Within 189×117mm, on focal position and environment temperature at 20°C±1°C, and workpiece is less than 2kg, L is the travel of stage

④ Within 180×90mm, on focal position and environment temperature at 20°C±1°C, and workpiece is less than 2kg, L is the travel of stage

Continued from previous page

- One or more workpieces can be measured by one step operation
- Place workpieces at any position
- Focus and measure automatically
- Measurement of 999+dimensions and 300+workpieces
- Suitable for parts with high precision for medium and small sizes

STANDARD DELIVERY

Main unit	1 pc
Computer	1 pc
Software	1 pc



rotary table (optional)



11.6" LCD (optional)

OPTIONAL ACCESSORY

Data transmission function of software	QMS-23-D1
CAD import function of software	QMS-23-C1
Laser sensor	QMS-43-SJ1 (must be installed in factory)
Foot-switch	QMS-43-FS1
11.6" LCD	QMS-23-B1 (must be installed in factory)
MES transmission function of software	QMS-23-E1
Rotary table	QMS-43-RT1 (must be installed in factory)

Software (included)

- Automatically measure widths, holes, rings, angles at the same time, simple and efficient

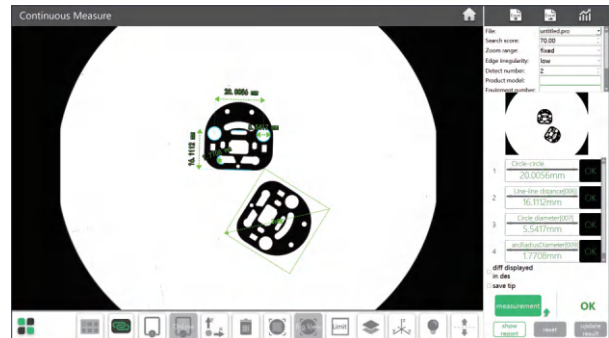
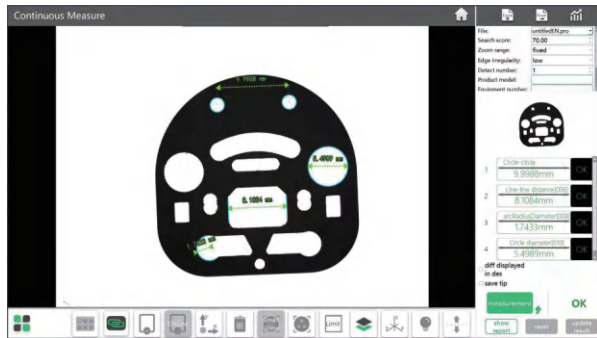

- Measuring result can be stored automatically. OK items and NG items can be counted automatically



SMALL VIEW FIELD OF QMS-A220 AND QMS-A315 SUITABLE FOR MEASURING SMALL SIZES SUCH AS THREADS AND CHAMFERS

QUICK MEASUREMENT SYSTEMS (WITH STITCHING)



QMS-A220

coaxial light illumination (optional)

software (included)



computer (included)

coaxial light illumination (optional)

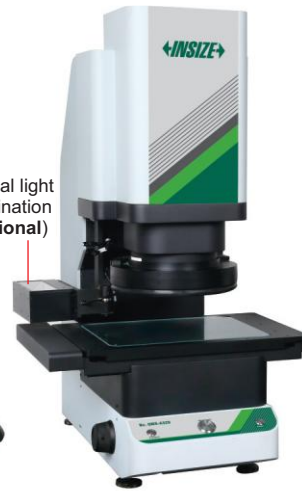

QMS-A320

computer (included)

software (included)

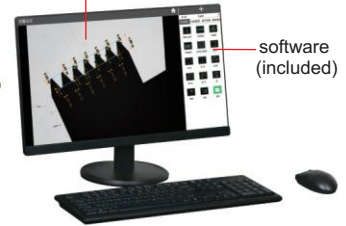

SPECIFICATION

Code		QMS-A220		QMS-A315		QMS-A320	
Optical lens		dual-field dual-telecentric low-distortion lens					
View field range		wide view field	small view field	wide view field	small view field	wide view field	small view field
Measurement range		93×62mm	20×16mm	100×80mm	25×20mm	150×110mm	50×35mm
Measurement accuracy *		±3μm ^①	±1μm ^②	±3μm ^①	±1μm ^②	±5μm ^③	±2μm ^④
Repeatability		±1μm	±0.5μm	±1μm	±0.5μm	±1μm	±0.5μm
Max. weight of workpiece		5kg					
Measurement time		<2s					
Measurement data		2D measurement					
Power supply		220V, 50Hz, 600W					
Illumination system	back light	telecentric illuminator, green light					
	ring light	4-zone circular white high light circular (directional) low-angle green light (electric)					
	coaxial light (optional)	vertical illuminator, white light					
Environmental requirement		temperature: 20°C±2°C, relative humidity: 30%~80%, vibration: <0.002g, less than 15Hz					
Dimension (L×W×H)		532×480×766mm		532×497×766mm		669×510×883mm	
Weight		50kg		60kg		68kg	

* The optimum temperature is 20°C±1°C

- ① Within 80×64mm, on focal position and environment temperature at 20°C±1°C
- ② Within 20×16mm, on focal position and environment temperature at 20°C±1°C
- ③ Within 120×88mm, on focal position and environment temperature at 20°C±1°C
- ④ Within 40×28mm, on focal position and environment temperature at 20°C±1°C
- ⑤ Within 180×180mm, on focal position, environment temperature at 20°C±1°C, and workpiece is less than 2kg, L is the travel of stage
- ⑥ Within 117×117mm, on focal position, environment temperature at 20°C±1°C, and workpiece is less than 2kg, L is the travel of stage
- ⑦ Within 270×180mm, on focal position, environment temperature at 20°C±1°C, and workpiece is less than 2kg, L is the travel of stage
- ⑧ Within 207×117mm, on focal position, environment temperature at 20°C±1°C, and workpiece is less than 2kg, L is the travel of stage
- ⑨ Within 270×189mm, on focal position, environment temperature at 20°C±1°C, and workpiece is less than 2kg, L is the travel of stage
- ⑩ Within 180×121mm, on focal position, environment temperature at 20°C±1°C, and workpiece is less than 2kg, L is the travel of stage

To be continued

Continued from previous page

- One or more workpieces can be measured by one step operation
- Place workpieces at any position
- Focus and measure automatically
- Measurement of 999+dimensions and 200+workpieces
- **QMS-A220** and **QMS-A315** are suitable for small and medium-size parts with high precision requirements
- **QMS-A320** is suitable for medium-size parts with low accuracy requirements and fast efficiency requirements

STANDARD DELIVERY

Main unit	1 pc
Computer	1 pc
Software	1 pc



rotary table (optional)



11.6" LCD (optional)

OPTIONAL ACCESSORY

Coaxial light illumination	QMS-23-A3 (for QMS-A220, QMS-A315) QMS-23-A4 (for QMS-A320)
Data transmission function of software	QMS-23-D1
CAD import function of software	QMS-23-C1
Laser sensor	QMS-43-SJ1 (for QMS-A315)
Foot-switch	QMS-43-FS1
11.6" LCD	QMS-23-B1 (must be installed in factory)
Rotary table	QMS-43-RT1 (must be installed in factory)

Software (included)

- Automatically measure widths, holes, rings, angles at the same time, simple and efficient

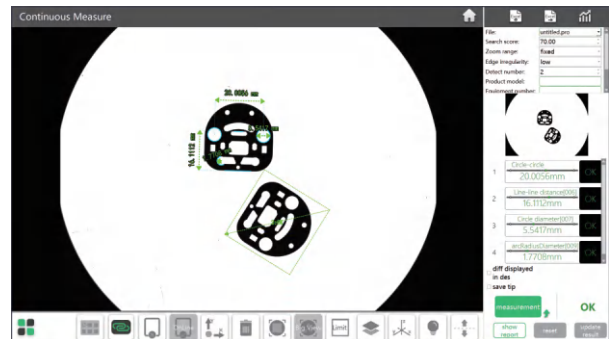
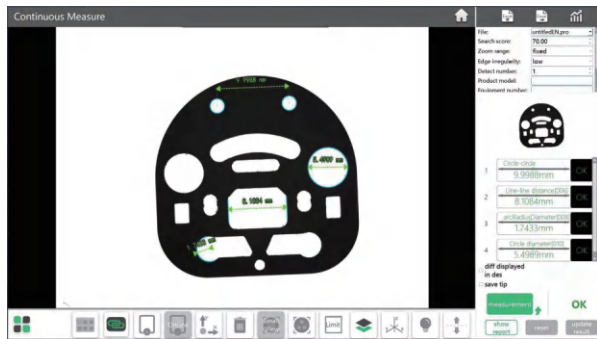

- Measuring result can be stored automatically. OK items and NG items can be counted automatically



NOTE: NOT SUITABLE FOR SMALL SIZES SUCH AS THREADS, CHAMFERS, ETC.

QUICK MEASUREMENT SYSTEMS (WITHOUT STITCHING)

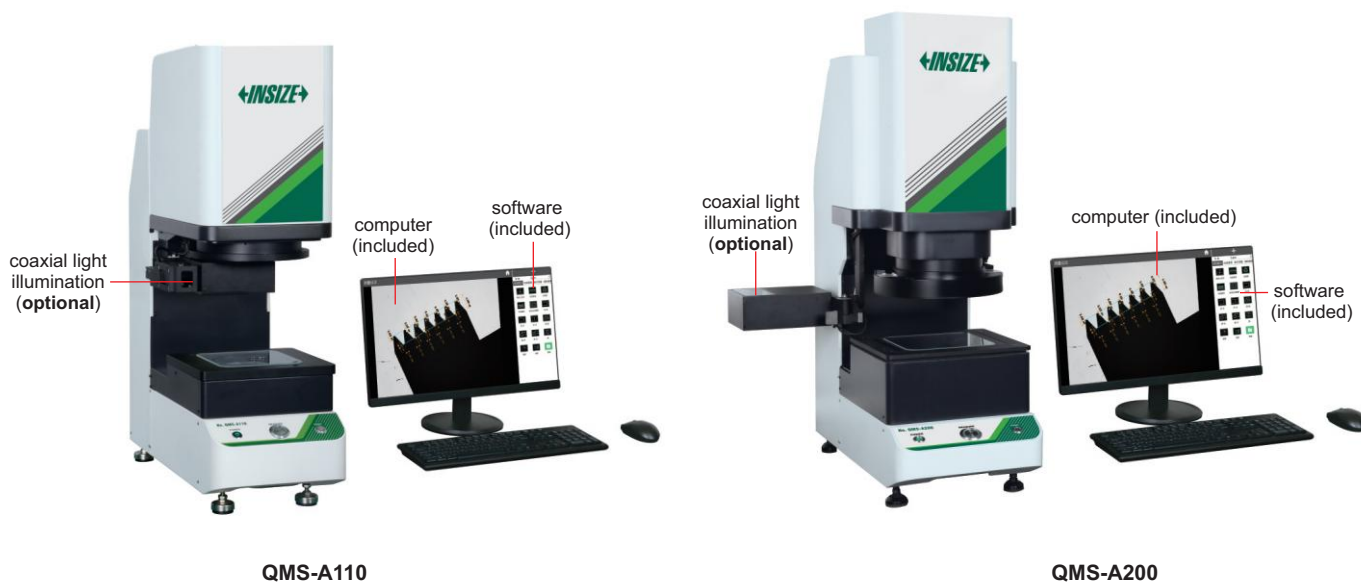

SPECIFICATION

Code	QMS-A110	QMS-A200	
Optical lens	low-distortion lens, single-field telecentric Ø100mm	dual-field dual-telecentric low-distortion lens wide view field: Ø150mm small view field: Ø50mm	
View field range	100×80mm	wide view field 150×110mm	small view field 50×35mm
Measurement range (X×Y)	98×78mm	148×108mm	48×33mm
Measurement accuracy *	±3µm ①	±5µm ②	±2µm ③
Repeatability	±1µm	±1µm	±0.5µm
Max. weight of workpiece	5kg		
Measurement time	<2s		
Measurement data	2D measurement		
Power supply	220V, 50Hz, 600W		
Illumination system	back light	telecentric illuminator, green light	
	ring light	4-zone circular white high light circular (directional) low-angle green light (eletric)	
	coaxial light (optional)	vertical illuminator, white light	
Environmental requirement	temperature: 20°C±2°C, relative humidity: 30%~80%, vibration: <0.002g, less than 15Hz		
Dimension (L×W×H)	580×235×790mm	638×336×885mm	
Weight	40kg	60kg	

* The optimum temperature is 20°C±1°C

- ① Within 80×64mm, on focal position and environment temperature at 20°C±1°C
- ② Within 120×88mm, on focal position and environment temperature at 20°C±1°C
- ③ Within 40×28mm, on focal position and environment temperature at 20°C±1°C

Continued from previous page

- One or more workpieces can be measured by one step operation
- Place workpieces at any position
- Focus and measure automatically
- Measurement of 999+dimensions and 200+workpieces
- **QMS-A110** is suitable for measuring small flat parts
- **QMS-A200** is suitable for measuring flat parts with low precision requirements and small surface sizes



11.6" LCD (optional)

STANDARD DELIVERY

Main unit	1 pc
Computer	1 pc
Software	1 pc

OPTIONAL ACCESSORY

Coaxial light illumination	QMS-23-A3 (for QMS-A110) QMS-23-A4 (for QMS-A200)
Data transmission function of software	QMS-23-D1
CAD import function of software	QMS-23-C1
Foot-switch	QMS-43-FS1
11.6" LCD	QMS-23-B1 (must be installed in factory)

Software (included)

- Automatically measure widths, holes, rings, angles at the same time, simple and efficient

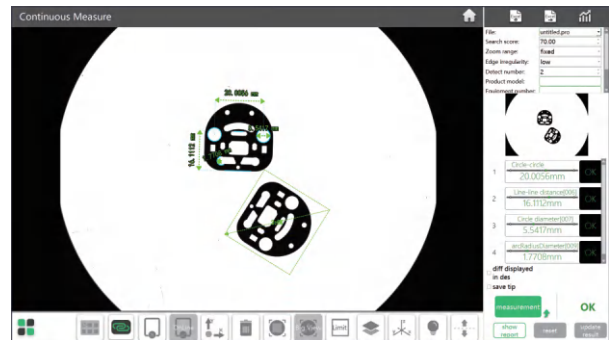
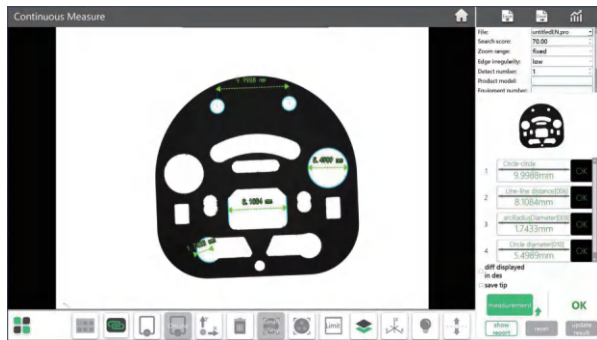

- Measuring result can be stored automatically. OK items and NG items can be counted automatically



SUITABLE FOR MEASURING
SHAFT WORKPIECES

HORIZONTAL QUICK MEASUREMENT SYSTEM CODE QMS-B530

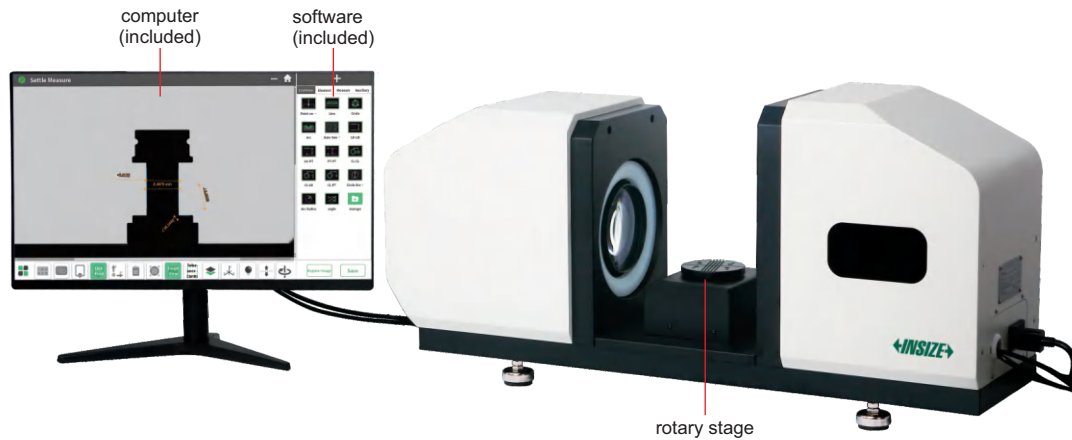

- One or more workpieces can be measured by one step operation
- Focus and measure automatically
- Suitable for measuring shaft workpieces

SPECIFICATION

Optical lens		Ø100mm dual-telecentric lens
Measurement range		100×80mm
Measurement accuracy*	axial	$\pm(5+L/20)\mu\text{m}$ ①
	radial	$\pm(3+D/20)\mu\text{m}$ ②
Repeatability	axial	$\pm 2\mu\text{m}$
	radial	$\pm 1\mu\text{m}$
Illumination system	transmission light	telecentric illuminator, green light
	surface light (optional)	high angle ring, white light
Max. weight of workpiece		3kg
Measurement time		<2s
Measurement data		2D measurement
Environmental requirement		temperature: 20°C±2°C, relative humidity: 30%~80%, vibration: <0.002g, less than 15Hz
Power supply		220V, 50Hz, 600W
Dimension (L×W×H)		790×230×385mm
Weight		27kg

* The optimum temperature is 20°C±1°C

① on focal position and environment temperature at 20°C±1°C, and workpiece is less than 2kg, L is the workpiece length in mm

② on focal position and environment temperature at 20°C±1°C, and workpiece is less than 2kg, D is the workpiece diameter in mm

Continued from previous page

STANDARD DELIVERY

Main unit	1 pc
Computer	1 pc
Software	1 pc

OPTIONAL ACCESSORY

Data transmission software	QMS-23-D1
CAD import software	QMS-23-C1
Foot-switch	QMS-43-FS1
MES transmission software	QMS-23-E1
Surface light	QMS-23-F1 (must be installed in factory)

Software (included)

- Automatically measure heights, diameters, perpendicularity, angles at the same time, simple and efficient

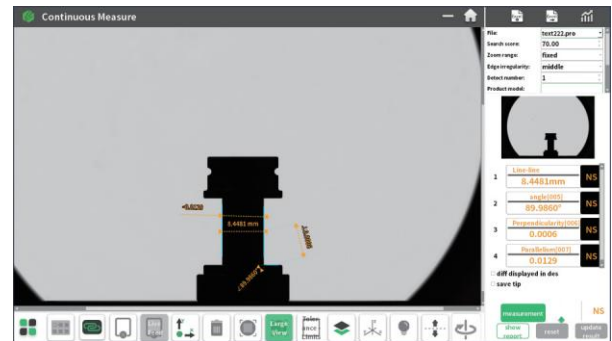
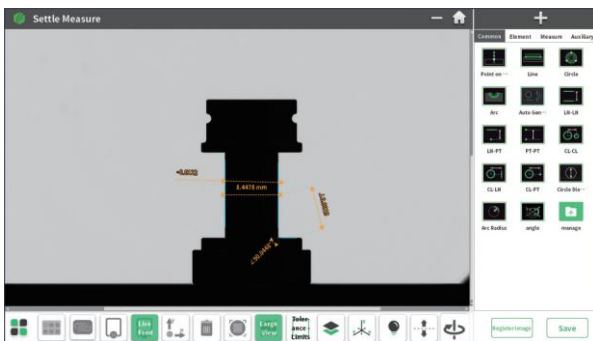

- Measuring result can be stored automatically. OK items and NG items can be counted automatically



3D PROBE WITH 3D SOFTWARE FOR 3D MEASUREMENT



2D+3D COMPOSITE CNC VISION MEASURING SYSTEMS

INSPECTION CERTIFICATE



lens with coaxial light (included)



programmable segmented ring light (included)

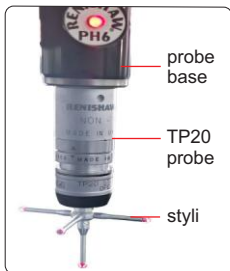

advanced probe set (optional)

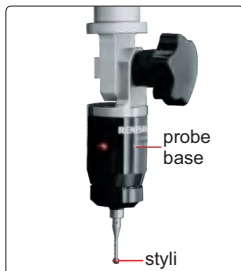

standard probe set (optional)



computer is included

ISD-U322

- Motorized zoom objective
- Can import 3D drawings
- Vision measurement and probe measurement can be used in the same program
- Granite platform, column and stage, more stable
- Double close-loop motion control, with precise positioning performance in high-speed movement
- Panasonic servo control motor
- 40 independent surface light source, 200-step adjustment
- Servo motors for X, Y, Z axis

SPECIFICATION

Code	ISD-U322	ISD-U432	ISD-U532	ISD-U542
Measuring range (X×Y×Z)	300×200×200mm	400×300×200mm	500×300×200mm	500×400×200mm
Stage size	600×390mm	700×490mm	800×490mm	800×590mm
Glass stage size	350×250mm	450×350mm	550×350mm	550×450mm
Resolution of X/Y/Z axis	0.5μm			
Accuracy (vision)	≤(2+L/200)μm (L is the measuring length in mm)			
Accuracy (probe)	≤(3+L/200)μm (L is the measuring length in mm)			
Repeatability	1.5μm			
Objective	0.7X~4.5X (zoom)			
Working distance	55mm			
View field (diagonal length)	1.3~7.9mm			
Magnification	36X~210X (on 21.5" monitor)			
Camera	1/2" color CCD, 2M pixel			
Illumination	surface	coaxial light, programmable segmented ring light		
	contour	adjustable LED light		
Max. height of workpiece	195mm			
Max. weight of workpiece	20kg	30kg	35kg	35kg
Operation system	Windows 10/11			
Drive method	automatic			
Power supply	220V, 50/60Hz			
Dimension (L×W×H)	1400×900×1780mm	1600×1120×1780mm	1650×1120×1780mm	1650×1220×1780mm
Weight	440kg	560kg	580kg	620kg

To be continued

Continued from previous page

STANDARD DELIVERY

Main unit	1 pc
Dongle	1 pc
Software	1 pc
Lens with coaxial light	1 pc
Controller	1 pc
Computer	1 pc
Calibration glass chart	1 pc
Laser positioner	1 pc
Clay	1 pc
Anti-dust cover	1 pc

OPTIONAL ACCESSORY

0.5X auxiliary objective		code: ISD-U-OB05X , working distance: 175mm magnification: 18~105X (on 21.5" monitor)
2X auxiliary objective		code: ISD-U-OB2X , working distance: 36mm magnification: 72~420X (on 21.5" monitor)
Standard probe set * (RENISHAW)		code: ISD-U-MCP (must be installed in factory) includes MCP probe base, Ø2mm and Ø3mm styli, Ø25mm calibration ball
Advanced probe set * (RENISHAW)	probe base	code: ISD-U-BASE (must be installed in factory)
	probe	code: ISD-U-TP20 , includes Ø2mm styli
	styli	ISQ-20 series (M2) optional , refer to page 616
Probe replacement rack		code: ISD-U-MCR20
Office software		code: 7313-OFFICE

* Must purchase standard probe set or advanced probe set

SOFTWARE (INCLUDED)

2D MEASUREMENT

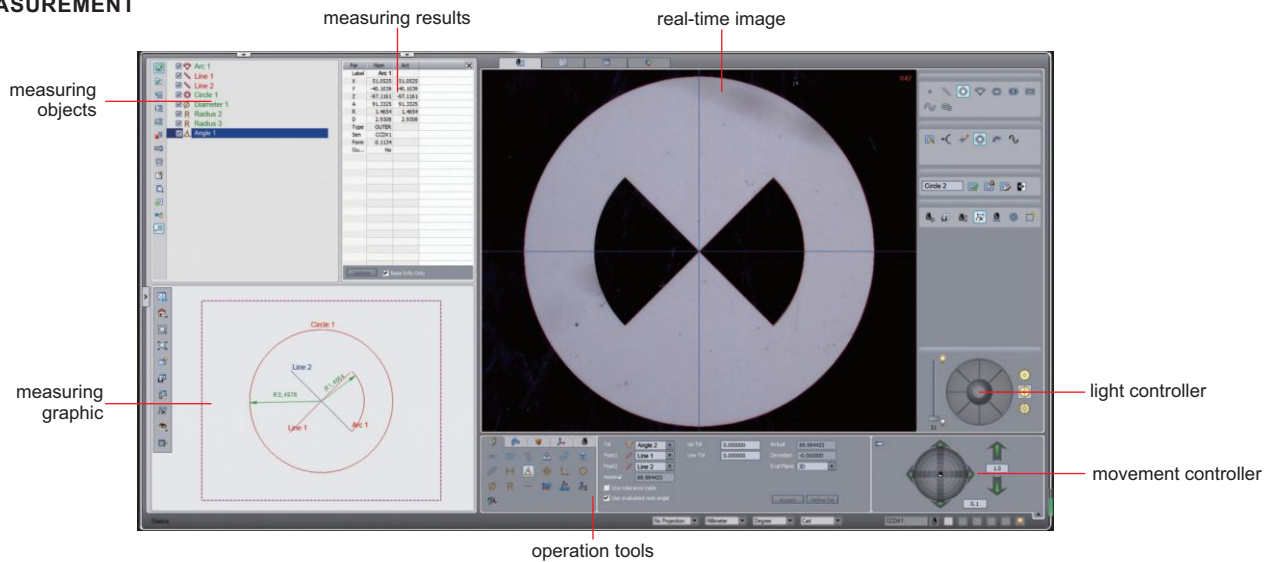

3D MEASUREMENT

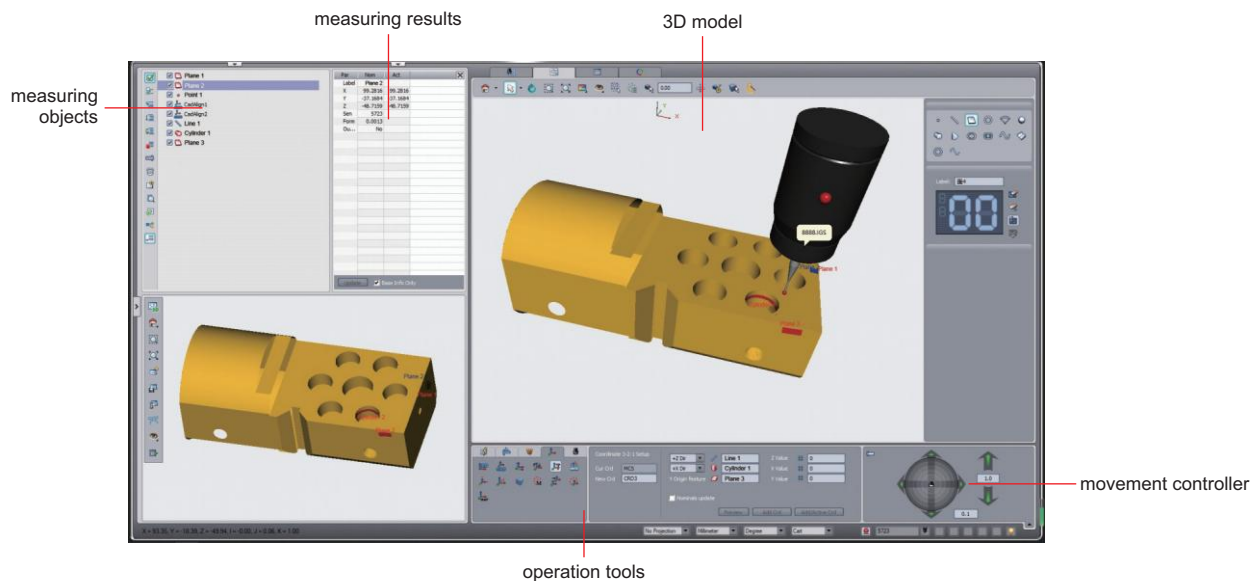



HORIZONTAL VISION MEASURING SYSTEM CODE ISD-W3150



demo sample (optional)

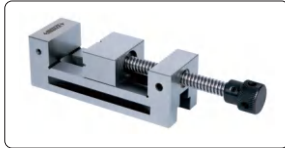

vise (optional)



computer is included

SPECIFICATION

Measuring range (X×Z)	300×150mm	
Accuracy	≤(4+L/25)μm L is the measuring length in mm	
Resolution	0.5μm	
Y travel range (focus)	125mm	
Stage	metal stage size	455×126mm
	turning range	±15°
	max. load capacity	30kg
Objective	0.7X~4.5X (zoom)	
Working distance	96mm	
View field (diagonal length)	1.3~8.2mm	
Magnification	34X~213X	
Display	19"	
Camera	1/3" CMOS, 0.8M pixel	
Illumination	surface and contour with adjustable LED	
Operation system	Windows 10	
Drive method	manual	
Power supply	220V, 50Hz	
Dimension (L×W×H)	1164×634×1048mm	
Weight	200kg	



table (optional)

STANDARD DELIVERY

Main unit (including computer)	1 pc
Software	1 pc
Calibration glass chart	1 pc
Clay	1 pc
Anti-dust cover	1 pc

MEASURING SOFTWARE (INCLUDED)

real-time image measuring results X/Y/Z axis

measuring graphic

measuring objects

measuring tools

OK

OPTIONAL ACCESSORY

0.5X auxiliary objective	code: ISD-W-OB05X working distance: 175mm magnification: 17~106.5X
2X auxiliary objective	code: ISD-W-OB2X working distance: 32mm magnification: 68~426X
Office software	code: 7313-OFFICE
Table	code: ISD-W-TABLE
Vise	code: ISP-A3000-VISE
Demo sample	code: ISP-A3000-DEMO

AUTOMATIC CNC VISION MEASURING SYSTEM (ADVANCED TYPE) CODE ISD-F432



- Stable and high-precision measurement under high-speed, silent and stable mode
- Accurately detect the edge of surface size



six-ring eight-zone ring light (included)



vertical light (included)

SPECIFICATION

Camera		giga-bit network camera (650TVL)
Measuring range (X*Y*Z)		400×300×200mm
Granite stage size		827×480mm
Glass stage size		450×350mm
Resolution of X/Y/Z axis		0.5μm
Accuracy of X/Y axis		≤(2+L/250)μm (L is the measuring length in mm)
Accuracy of Z axis		≤(3+L/150)μm (L is the measuring length in mm)
Objective		0.7X~5X (zoom)
Working distance		68mm
Magnification		28X~155X (on 23.5" monitor)
Illumination	surface	six-ring eight-zone ring light and vertical light
	contour	bottom horizontal light
Max. height of workpiece		200mm
Max. weight of workpiece		30kg
Operation system		Windows 10
Power supply		220V±10% (AC), 50Hz
Environment requirement		temperature: 18~24°C, relative humidity: 30~75%
Dimension (L*W*H)		1270×910×1750mm
Weight		360kg

To be continued

Continued from previous page

STANDARD DELIVERY

Main unit	1 pc
Computer	1 pc
Computer table	1 pc
Calibration glass chart	1 pc
Software	1 pc



laser probe (optional)

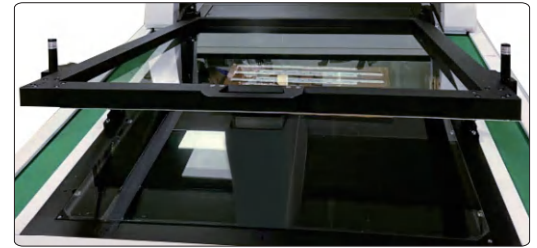
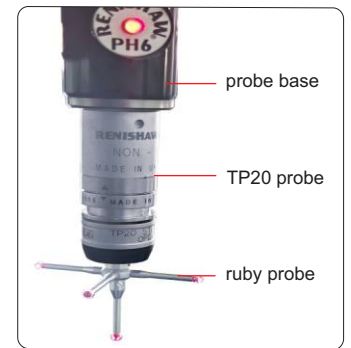

plate clamp (optional)

OPTIONAL ACCESSORY

Advanced probe	probe base *	code ISD-F-BASE1 (must be installed before shipment)
	probe *	code ISD-F-TP20 (must be installed before shipment)
	ruby probe	optional M2 probe series with ISQ-01
Standard probe	probe base *	code ISD-F-BASE2 (must be installed before shipment)
	ruby probe	code ISD-F-P2 code ISD-F-P3
Laser probe ** (can measure glass thickness, step height, flatness, height etc.)		code ISD-F-PB (must be installed before shipment)
Special lens for large field navigation		code ISD-F-LENS (must be installed before shipment)
PLC full-angle intelligent programmable lighting system		code ISD-F-LIGHT (must be installed before shipment)
Plate fixture (manual self-locking tempered glass)		code ISD-F-HOLDER glass size: 450×350mm can be customized
Protector		code ISD-F-PROTECTOR (must be installed before shipment)
Contour comparison module		code ISD-F-PROFILE
Office software		code 7313-OFFICE



advanced probe (optional)



standard probe (optional)

* The probe head and probe are Renishaw brand

** Laser probe is KEYENCE brand

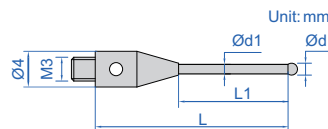

STYLUS (INCLUDED) SPECIFICATION

Code	Material	Ød	Ød1	L	L1	Quantity
ISD-F-P2	ruby ball/stainles steel stem	Ø2mm	Ø1.4mm	21mm	8mm	1 pc
ISD-F-P3		Ø3mm	Ø1.5mm		12mm	1 pc

To be continued

Continued from previous page

MEASURING SOFTWARE (INCLUDED)

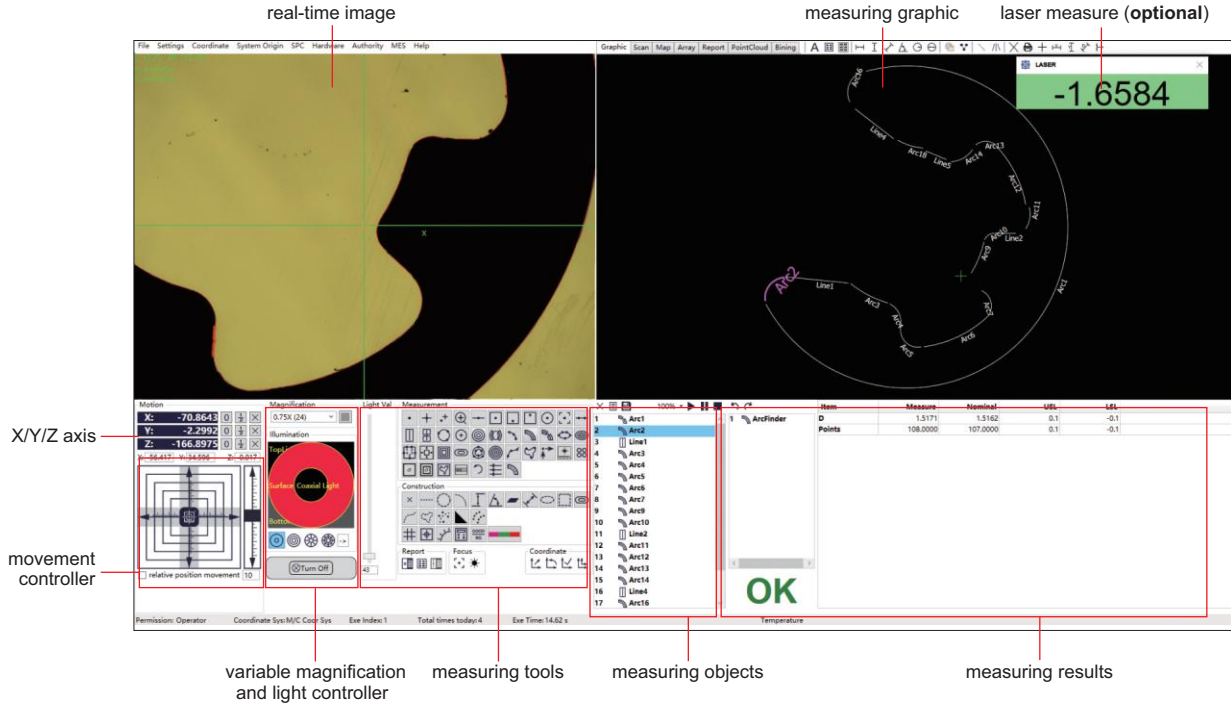

- Operation system: Windows 10
- Language: English
- Image measuring methods: crosshair point, manual point, auto point, zoom in point, line point, center point, lowest point, highest point, closest point, focus point
- Constructable elements: point, line circle, arc, height, angle, plane, distance, ellipse, rectangle, construction ring/groove, spline, closed spline, profile, geometric tolerance
- Geometric tolerance: concentricity, parallelism, verticality, angularity, symmetry, circular, arc profile
- Measurement elements can be translated and rotated
- Measuring data can export to Excel, DXF and other format files. The image area can save BMP image format
- The software includes CAD drawing import module
- The software includes SPC analysis module. The measurement software is seamlessly linked with the SPC module. After the measurement is completed, the measurement software automatically imports the data into the SPC database, allowing simple data analysis
- Dimension measuring tools:

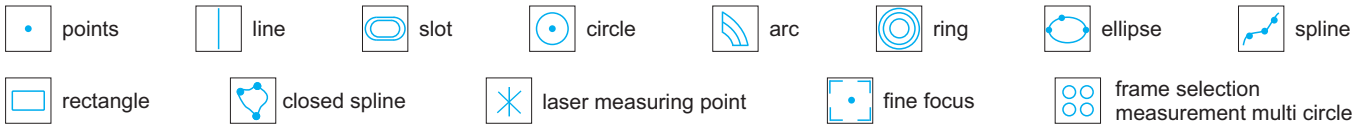

■ Element annotations

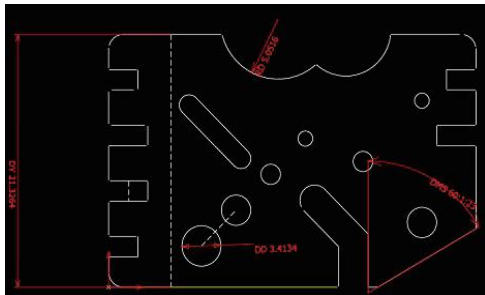

■ Accurately detect the edge of the surface size

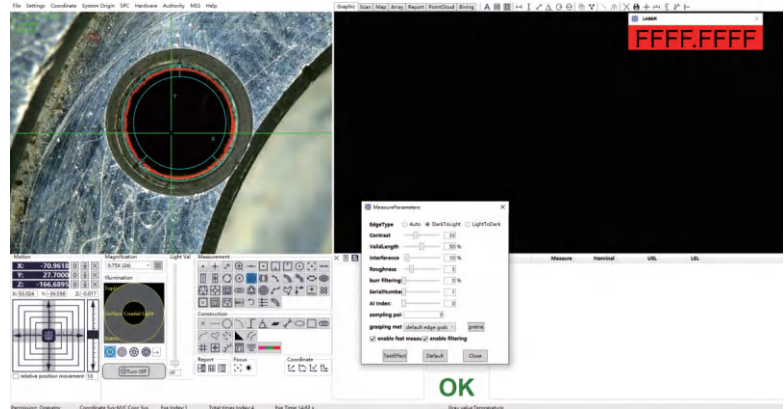

MOTORIZED ZOOM
OBJECTIVE IS OPTIONAL



**INSPECTION
CERTIFICATE**

CNC VISION MEASURING SYSTEMS (BASIC TYPE)

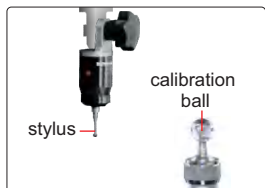

probe (**optional**), includes
Ø2mm and Ø3mm styli,
Ø25mm calibration ball,
measuring accuracy is 10µm

- Automatic edge-detection, focus, measuring, contour scanning, calibration, etc.
- Double close-loop motion control, with precise positioning performance in high-speed movement
- Granite body, more stable
- Servo motors for X, Y, Z axis
- SPC function for large quantity measurement

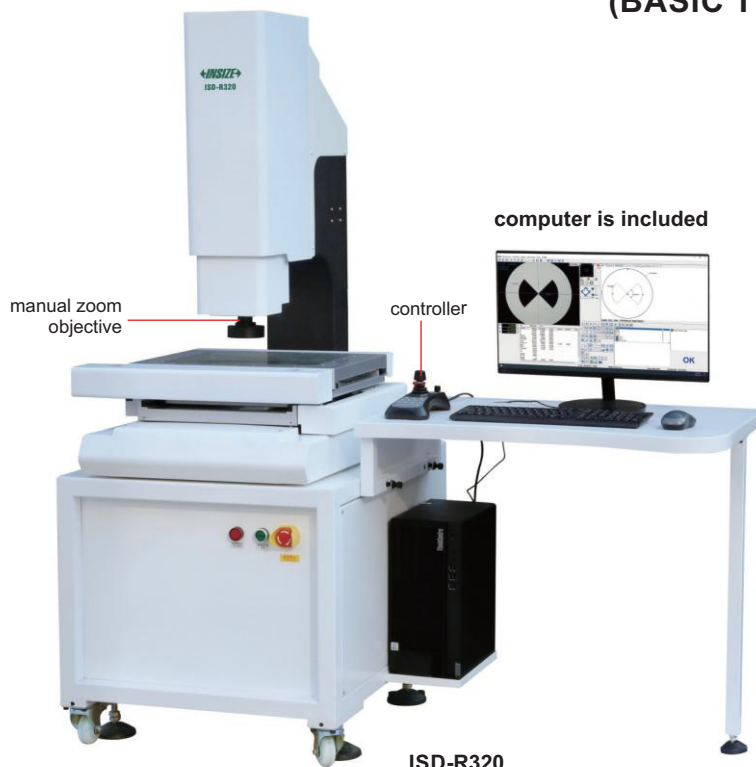

ISD-R320

STANDARD DELIVERY

Main unit	1 pc
Software	1 pc
Dongle	1 pc
Controller	1 pc
Computer	1 pc
Calibration glass chart	1 pc
Clay	1 pc
Anti-dust cover	1 pc



programmable segmented ring light (included)



lens with coaxial light (**optional**)

SPECIFICATION

Code	ISD-R320	ISD-R430	ISD-R540
Measuring range (XxYxZ)	300×200×150mm	400×300×150mm	500×400×150mm
Stage size	500×330mm	606×466mm	706×566mm
Glass stage size	350×280mm	450×350mm	550×450mm
Resolution of X/Y/Z axis	0.5µm		
Accuracy of X/Y axis	≤(3+L/200)µm (L is the measuring length in mm)		
Repeatability of X/Y axis	2µm		
Objective	0.7X~4.5X (zoom)		
Working distance	55mm		
View field (diagonal length)	1.3~7.6mm		
Magnification	29X~143X (on 21.5" monitor)		
Camera	1/3" color CCD, 0.3M pixel		
Illumination	contour	programmable segmented ring light	
	surface	adjustable LED light	
Max. height of workpiece	150mm		
Max. weight of workpiece	20kg		
Operation system	Windows 10/11		
Drive method	automatic		
Power supply	220V, 50/60Hz		
Dimension (L×W×H)	720×770×1780mm	700×1000×1780mm	800×1040×1780mm
Weight	270kg	325kg	500kg

To be continued

Continued from previous page

OPTIONAL ACCESSORY

0.5X auxiliary objective	code: ISD-Y-OB05X working distance: 175mm; magnification: 14.5~71.5X (on 21.5" monitor)
2X auxiliary objective	code: ISD-Y-OB2X working distance: 36mm; magnification: 58~286X (on 21.5" monitor)
Probe	code: ISD-Y-PROBE includes Ø2mm and Ø3mm styli, Ø25mm calibration ball
Vision measuring system with coaxial light lens	code: ISD-R320L, ISD-R430L, ISD-R540L
Office software	code: 7313-OFFICE

SOFTWARE (INCLUDED)

real-time image light controller measuring graphic

XYZ axis measuring results measuring objects measuring tools

CNC VISION MEASURING SYSTEMS (WITH STAND)

MOTORIZED ZOOM OBJECTIVE IS OPTIONAL



lens with coaxial light (included)

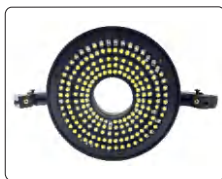

programmable segmented ring light (included)



software flash disk (included)

- Automatic edge-detection, focus, measuring, contour scanning, calibration, etc.
- Servo motors for X, Y, Z axis
- Granite body, more stable
- SPC function for large quantity measurement
- Measuring software is included (page 671~672)

STANDARD DELIVERY

Main unit	1 pc
Dongle	1 pc
Software	1 pc
Computer	1 pc
Display	1 pc
Lens with coaxial light	1 pc
Controller	1 pc
Calibration glass chart	1 pc
Laser positioner	1 pc
Clay	1 pc
Anti-dust cover	1 pc



To be continued

Continued from previous page

SPECIFICATION

Code	ISD-E320	ISD-E430
Measuring range (X×Y×Z)	300×200×200mm	400×300×200mm
Stage size	556×406mm	561×556mm
Glass stage size	350×250mm	450×350mm
Resolution of X/Y/Z axis	0.5μm	
Accuracy of X/Y axis	≤(2.5+L/200)μm (L is measuring length in mm)	≤(3.5+L/200)μm (L is measuring length in mm)
Repeatability of X/Y axis	2μm	
Objective (manual zoom)	0.7X~4.5X (zoom)	
Working distance	92mm	
View field (diagonal length)	1.7~11.1mm	
Magnification	33X~208.6X (on 24" monitor)	
Camera	giga-bit network camera	
Illumination	surface	coaxial light, programmable segmented ring light
	contour	adjustable LED light
Max. height of workpieces	200mm	
Max. weight of workpieces	30kg	
Operation system	Windows 7/8/10	
Drive method	automatic	
Power supply	220V, 50/60Hz	
Dimension (L×W×H)	1420×915×1830mm	1650×1170×1900mm
Weight	500kg	700kg

OPTIONAL ACCESSORY

0.5X auxiliary objective	code: ISD-V-OB05X working distance: 175mm magnification: 16.5~104.3X (on 24" monitor)
2X auxiliary objective	code: ISD-V-OB2X working distance: 36mm magnification: 66~417.2X (on 24" monitor)
Probe	code: ISD-V-PROBE includes Ø2mm and Ø3mm styli, Ø25mm calibration ball
Office software	code: 7313-OFFICE
Laser probe	code: ISD-V-LASER

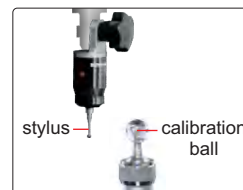

probe (optional), includes Ø2mm and Ø3mm styli, Ø25mm calibration ball, measuring accuracy is 10μm



laser probe (optional) measuring accuracy is 5μm

SOFTWARE (INCLUDED)

- Refer to page 671~672 for details

The screenshot shows the INSIZE software interface with several components labeled:

- real-time image**: The main window showing a live video feed of a part with a red crosshair.
- X/Y/Z axis**: The coordinate system controls on the right side of the interface.
- light controller**: The light control panel on the right side of the interface.
- magnification of selected points**: A zoomed-in view of a specific point on the part.
- measuring objects**: The list of measured features at the bottom left, including ARC1, L1N1, L1N2, L1N3, and L1N4.
- measuring results**: The data table at the bottom center showing parameters like Center X, Center Y, and Diameter.
- measuring tools**: The toolbar on the left side of the interface.
- movement controller**: The movement control panel at the bottom center.
- measuring graphic**: The graphical representation of the measured part with dimensions like R1.4999 and D5.0017.

CNC VISION MEASURING SYSTEMS (STANDARD TYPE)



- Automatic edge-detection, focus, measuring, contour scanning, calibration, etc.
- Servo motors for X, Y, Z axis
- SPC function for large quantity measurement
- Measuring software is included (page 671~672)

SPECIFICATION

Code	motorized zoom lens	ISD-V220ZA	ISD-V220ZHN	ISD-V270ZA	ISD-V270ZHN	ISD-V370ZA	ISD-V370ZHN
	manual zoom lens	ISD-V220CNCA	ISD-V220HN	ISD-V270CNCA	ISD-V270HN	ISD-V370CNCA	ISD-V370HN
Measuring range (X×Y×Z)		220×120×150mm	220×120×300mm	270×170×150mm	270×170×300mm	370×270×150mm	370×270×300mm
Stage size		450×280mm	450×280mm	500×330mm	500×330mm	606×466mm	606×466mm
Glass stage size		306×196mm	306×196mm	350×250mm	350×250mm	450×350mm	450×350mm
Resolution of X/Y/Z axis		0.5μm					
Accuracy of X/Y axis		≤(2.5+L/100)μm (L is the measuring length in mm)				≤(3.5+L/100)μm (L is the measuring length in mm)	
Repeatability of X/Y axis		2μm					
Objective		0.7X~4.5X (zoom)					
Working distance		92mm					
Magnification		33.0X~208.6X (with manual zoom lens, on 24" monitor) 31.9X~188.7X (with motorized zoom lens, on 24" monitor)					
Camera		giga-bit network camera					
Illumination	surface	coaxial light, programmable segmented ring light					
	contour	adjustable LED light					
View field (diagonal length)		1.5~10.8mm					
Max. height of workpiece		150mm	300mm	150mm	300mm	150mm	300mm
Max. weight of workpiece		30kg					
Operation system		Windows 7/8/10					
Drive method		automatic					
Power supply		220V, 50/60Hz					
Dimension (L×W×H)		760×600×900mm	760×600×1050mm	760×600×900mm	760×600×1050mm	970×670×940mm	970×670×1090mm
Weight		146kg	156kg	168kg	178kg	266kg	276kg

To be continued

Continued from previous page



software flash disk (included)



laser probe (optional) measuring accuracy is 5µm

STANDARD DELIVERY

Main unit	1 pc
Software	1 pc
Computer	1 pc
24" display	1 pc
Len with coaxial light	1 pc
Controller	1 pc
Calibration glass chart	1 pc
Laser positioner	1 pc
Clay	1 pc
Anti-dust cover	1 pc

desk (optional)



probe (optional), includes Ø2mm and Ø3mm styli, Ø25mm calibration ball, measuring accuracy is 10µm

OPTIONAL ACCESSORY

0.5X auxiliary objective	code: ISD-V-OB05X , working distance: 175mm magnification: 16.5~104.3X (with manual zoom lens, on 24" monitor), 16.0~94.4X (with motorized zoom lens, on 24" monitor)
2X auxiliary objective	code: ISD-V-OB2X , working distance: 36mm magnification: 66~417.2X (with manual zoom lens, on 24" monitor), 63.8~377.4X (with motorized zoom lens, on 24" monitor)
Probe	code: ISD-V-PROBE , includes Ø2mm and Ø3mm styli, Ø25mm calibration ball
Laser probe	code: ISD-V-LASER
Office software	code: 7313-OFFICE
Desk	code: ISD-V-DESK

SOFTWARE (INCLUDED)

- Refer to page 671~672 for details

The screenshot shows the INSIZE software interface with several key components labeled:

- real-time image**: The main central window showing a live image of a circular object with a crosshair.
- X/Y/Z axis**: The coordinate system control panel on the right side of the interface.
- light controller**: A control panel on the right side used to manage the probe's lighting.
- magnification of selected points**: A zoomed-in view of a specific point on the object, showing its coordinates (R1.4999, D5.0017).
- measuring objects**: The list of detected features (AR1, LN1, LN2, LN4) shown in the bottom-left panel.
- measuring results**: The data table in the bottom-center showing parameters like Center X, Center Y, and their tolerances.
- measuring tools**: The toolbar on the left side of the interface containing various measurement and navigation tools.
- movement controller**: The central navigation controls (arrows and buttons) used to move the probe.

HIGH-DEFINITION MANUAL VISION MEASURING SYSTEMS

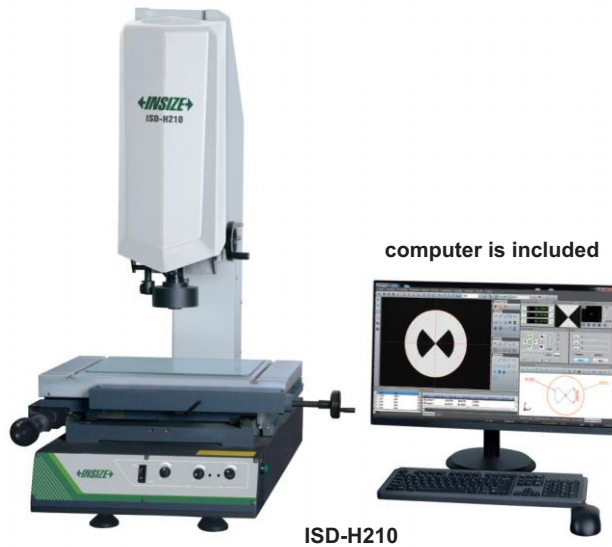

lens with coaxial light (**optional**, must be installed in factory)



probe (**optional**), includes Ø2mm and Ø3mm styli, Ø25mm calibration ball, measuring accuracy is 10µm

- High-definition image
- Large view field
- Electronic magnification feedback lens: when the objective lens magnification is changed manually, the software automatically selects the corresponding pre-calibration data and calibration is not needed

STANDARD DELIVERY

Main unit	1 pc
Computer	1 pc
Calibration glass chart	1 pc
Clay	1 pc
Foot switch	1 pc
Anti-dust cover	1 pc

SPECIFICATION

Code	ISD-H210	ISD-H320	ISD-H430
Measuring range (X×Y×Z)	200×100×150mm	300×200×150mm	400×300×150mm
Stage size	404×228mm	500×330mm	606×466mm
Glass stage size	260×160mm	350×250mm	450×350mm
Resolution of X/Y/Z axis	0.5µm		
Accuracy of X/Y axis	≤(2.5+L/100)µm (L is the measuring length in mm)		
Repeatability of X/Y axis	2µm		
Objective	0.58X~7.5X (zoom)		
View field (diagonal length)	1.4mm~14mm		
Working distance	82mm		
Magnification	27.4X~351X (on 24" monitor)		
Camera	giga-bit network camera		
Illumination	surface and contour with adjustable LED		
Max. height of workpiece	150mm		
Max. weight of workpiece	20kg		
Operation system	Windows 7/8/10		
Drive method	manual		
Power supply	110~240V, 50/60Hz		
Dimension (L×W×H)	540×560×850mm	760×600×900mm	970×670×940mm
Weight	110kg	140kg	240kg

OPTIONAL ACCESSORY

0.5X auxiliary objective	code: ISD-H-OB05X working distance: 155mm magnification: 13.7~175.5X (on 24" monitor)
2X auxiliary objective	code: ISD-H-OB2X working distance: 34.5mm magnification: 54.8~702X (on 24" monitor)
Probe	code: ISD-V-PROBE includes Ø2mm and Ø3mm styli, Ø25mm calibration ball
Vision measuring system with coaxial light lens	code: ISD-H210CL, ISD-H320CL, ISD-H430CL
Office software	code: 7313-OFFICE

To be continued

Continued from previous page

SOFTWARE (INCLUDED)

- Refer to page 671-672 for details

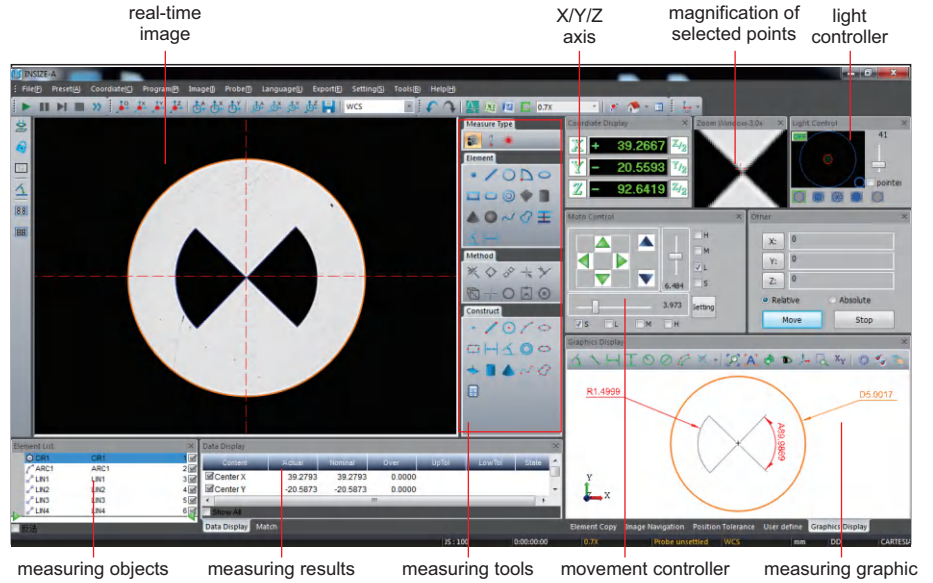

MANUAL VISION MEASURING SYSTEMS (STANDARD TYPE)



computer is included



lens with coaxial light (optional, must be installed in factory)

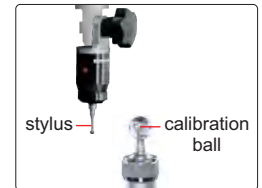

probe (optional), includes Ø2mm and Ø3mm styli, Ø25mm calibration ball, measuring accuracy is 10µm

SPECIFICATION

ISD-V250A

Code	ISD-V150A	ISD-V250A	ISD-V300A	ISD-V400A
Measuring range (X×Y×Z)	150×100×150mm	250×150×150mm	300×200×150mm	400×300×150mm
Stage size	354×228mm	450×280mm	500×330mm	606×466mm
Glass stage size	210×160mm	306×196mm	350×250mm	450×350mm
Resolution of X/Y/Z axis	0.5µm			
Accuracy of X/Y axis	≤(2.5+L/100)µm (L is the measuring length in mm)			
Repeatability of X/Y axis	2µm			
Objective	0.7X~4.5X (zoom)			
Working distance	92mm			
Magnification	29X~184X (on 21.5" monitor)			
Camera	1/3" color CCD, 0.3M pixel			
Illumination	surface and contour with adjustable LED			
Max. height of workpiece	150mm			
Max. weight of workpiece	20kg			
Operation system	Windows 7/8/10			
Drive method	manual			
Power supply	110/220V, 50/60Hz			
Dimension (L×W×H)	560×540×850mm	760×600×900mm	760×600×900mm	970×670×940mm
Weight	100kg	120kg	140kg	240kg

To be continued

Continued from previous page

STANDARD DELIVERY

Main unit	1 pc
Computer	1 pc
Calibration glass chart	1 pc
Clay	1 pc
Foot switch	1 pc
Anti-dust cover	1 pc

OPTIONAL ACCESSORY

0.5X auxiliary objective	code: ISD-V-OB05X working distance: 175mm magnification: 14.5~92X (on 21.5" monitor)
2X auxiliary objective	code: ISD-V-OB2X working distance: 36mm magnification: 58~368X (on 21.5" monitor)
Probe	code: ISD-V-PROBE includes Ø2mm and Ø3mm styli, Ø25mm calibration ball
Vision measuring system with coaxial light lens (with computer)	code: ISD-V150ACL, ISD-V250ACL, ISD-V300ACL, ISD-V400ACL
Office software	code: 7313-OFFICE

SOFTWARE (INCLUDED)

- Refer to page 671~672 for details

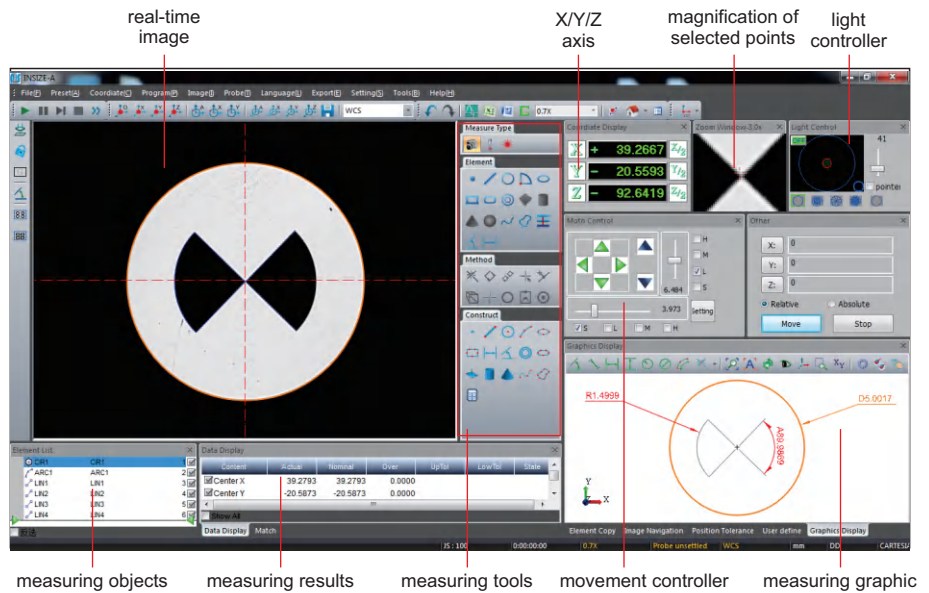

MANUAL VISION MEASURING SYSTEMS (BASIC TYPE)

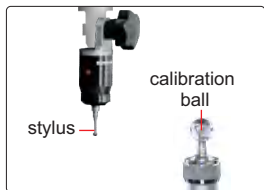

probe (optional), includes Ø2mm and Ø3mm styli, Ø25mm calibration ball, measuring accuracy is 10µm



lens with coaxial light (optional, must be installed in factory)



ISD-Y320

To be continued

Continued from previous page

SPECIFICATION

Code	Motorized focus	ISD-Y210D	ISD-Y320D	ISD-Y430D	ISD-Y530D
	Manual focus	ISD-Y210	ISD-Y320	ISD-Y430	ISD-Y530
Measuring range (X×Y×Z)		200×100×200mm	300×200×200mm	400×300×200mm	500×300×200mm
Stage size		404×228mm	500×330mm	606×466mm	706×466mm
Glass stage size		260×160mm	350×280mm	450×350mm	550×350mm
Resolution of X/Y/Z axis		1μm			
Accuracy of X/Y axis		≤(3+L/200)μm (L is the measuring length in mm)			
Repeatability of X/Y axis		2μm			
Objective		0.7X~4.5X (zoom)			
View field (diagonal length)		1.0~6.6mm			
Working distance		92mm			
Magnification		37.2X~236.0X (on 21.5" monitor)			
Camera		1/2" color CCD, 1.3M pixel			
Illumination		surface and contour with adjustable LED			
Max. height of workpiece		200mm			
Max. weight of workpiece		20kg			
Operation system		Windows 10/11			
Drive method		manual			
Power supply		220V, 50Hz			
Dimension (L×W×H)		556×540×860mm	670×660×950mm	720×950×1020mm	800×1040×1020mm
Weight		180kg	260kg	315kg	500kg

OPTIONAL ACCESSORY

0.5X auxiliary objective	code: ISD-Y-OB05X working distance: 175mm magnification: 18.6~118.0X (on 21.5" monitor)
2X auxiliary objective	code: ISD-Y-OB2X working distance: 36mm magnification: 74.5~472.0X (on 21.5" monitor)
Probe	code: ISD-Y-PROBE includes Ø2mm and Ø3mm styli, Ø25mm calibration ball
Vision measuring system with coaxial light lens	code: ISD-Y210CL (manual focus), ISD-Y210DCL (motorized focus) ISD-Y320CL (manual focus), ISD-Y320DCL (motorized focus) ISD-Y430CL (manual focus), ISD-Y430DCL (motorized focus) ISD-Y530CL (manual focus), ISD-Y530DCL (motorized focus)
Office software	code: 7313-OFFICE

STANDARD DELIVERY

Main unit	1 pc
Computer	1 pc
Calibration glass chart	1 pc
Clay	1 pc
Anti-dust cover	1 pc

SOFTWARE (INCLUDED)

CNC VISION MEASURING SYSTEMS



computer is included

ISD-V500N

- Automatic edge-detection, focus, measuring, contour scanning, calibration, etc.
- Servo motors for X, Y, Z axis
- SPC function for large quantity measurement

SPECIFICATION

Code	ISD-V500N	ISD-V501N	ISD-V500HN	ISD-V501HN
Measuring range (X*Y*Z)	470×370×200mm	500×400×200mm	470×370×400mm	500×400×400mm
Stage size	786×636mm	846×696mm	786×636mm	846×696mm
Glass stage size	570×470mm			
Resolution of X/Y/Z axis	0.5μm			
Accuracy of X/Y axis	≤(2.5+L/200)μm (L is measuring length in mm)			
Repeatability of X/Y axis	2μm			
Objective	0.7X~4.5X (zoom)			
Working distance	92mm			
View field (diagonal length)	1.5~10.8mm			
Magnification	33.0X~208.6X (on 24" monitor)			
Camera	giga-bit network camera			
Illumination	surface	coaxial light, programmable segmented ring light		
	contour	adjustable LED light		
Max. height of workpieces	200mm		400mm	
Max. weight of workpieces	30kg			
Operation system	Windows 7/10			
Drive method	automatic			
Power supply	220V, 50/60Hz			
Dimension (L*W*H)	1270×1200×1870mm	1405×1260×1870mm	1270×1200×2070mm	1405×1260×2070mm
Weight	870kg	1000kg	900kg	1030kg

To be continued

Continued from previous page

STANDARD DELIVERY

Main unit	1 pc
Video card with dongle	1 pc
Software disc	1 pc
Lens with coaxial light	1 pc
Controller	1 pc
Computer	1 pc
Calibration glass chart	1 pc
Laser positioner	1 pc
Clay	1 pc
Anti-dust cover	1 pc



lens with coaxial light (included)



programmable segmented ring light (included)

OPTIONAL ACCESSORY

0.5X auxiliary objective	code: ISD-V-OB05X working distance: 175mm magnification: 16.5~104.3X (on 24" monitor)
2X auxiliary objective	code: ISD-V-OB2X working distance: 36mm magnification: 66~417.2X (on 24" monitor)
Probe	code: ISD-V-PROBE includes Ø2mm and Ø3mm styli, Ø25mm calibration ball
Office software	code: 7313-OFFICE

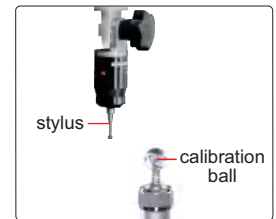

probe (**optional**), includes Ø2mm and Ø3mm styli, Ø25mm calibration ball, measuring accuracy is 10µm

SOFTWARE (INCLUDED)

- Refer to page 671~672 for details

The screenshot shows the INSIZE software interface with several key components labeled:

- real-time image:** The main window displays a circular target with two black lobes.
- X/Y/Z axis:** A coordinate system is visible in the top right corner.
- light controller:** A panel on the right side of the interface for controlling the light source.
- magnification of selected points:** A zoomed-in view of the target's center is shown in the bottom right.
- measuring objects:** The bottom left panel shows a list of measured features like ARC1, LIN1, etc.
- measuring results:** The bottom center panel displays numerical data for the selected features.
- measuring tools:** A central toolbar contains various measurement and construction tools.
- movement controller:** A panel on the right side for controlling the probe's movement.

CNC VISION MEASURING SYSTEMS

MOTORIZED ZOOM
OBJECTIVE IS OPTIONAL



VMM-L1001CN

- Automatic edge-detection, focus, measuring, contour scanning, calibration, etc.
- Servo motors for X, Y, Z axis, X, Y axis adopt linear guide rail structure, without air supply
- Fixed glass table and granite platform base, good stability
- SPC function for large quantity measurement
- Measuring software is included (page 671~672)

SPECIFICATION

Code	VMM-L600CN	VMM-L601CN	VMM-L800CN
Measuring range (X×Y×Z)	600×600×200mm	600×900×200mm	800×1000×200mm
Glass stage size	765×1238mm	702×1543mm	902×1643mm
Resolution of X/Y/Z axis	0.5μm		
Accuracy of X/Y axis	≤(3.5+L/200)μm (L is measuring length in mm)		
Repeatability of X/Y axis	2μm		
Objective (manual zoom)	0.7X~4.5X (zoom)		
Working distance	92mm		
View field (diagonal length)	1.7~11.1mm		
Magnification	33.0X~208.6X (on 24" monitor)		
Camera	giga-bit network camera		
Illumination	surface	coaxial light, programmable segmented ring light	
	contour	adjustable LED light	
Max. height of workpiece	200mm		
Max. weight of workpiece	35kg		
Operation system	Windows 7/8/10		
Drive method	automatic		
Power supply	AC 220V, 50/60Hz		
Dimension (L×W×H)	1445×1185×1560mm	1745×1220×1720mm	1850×1420×1720mm
Weight	1000kg	1400kg	2200kg

To be continued

Continued from previous page

SPECIFICATION

Code	VMM-L1000CN	VMM-L1001CN	VMM-L1200CN
Measuring range (X×Y×Z)	1000×1200×200mm	1000×1500×200mm	1200×1500×200mm
Glass stage size	1100×1831mm	1100×2113mm	1300×2113mm
Resolution of X/Y/Z axis	0.5μm		
Accuracy of X/Y axis	≤(3.5+L/200)μm (L is measuring length in mm)		
Repeatability of X/Y axis	2μm		
Objective(manual zoom)	0.7X~4.5X (zoom)		
Working distance	92mm		
View field (diagonal length)	1.7~11.1mm		
Magnification	33.0X~208.6X (on 24" monitor)		
Camera	giga-bit network camera		
Illumination	surface	coaxial light, programmable segmented ring light	
	contour	adjustable LED light	
Max. height of workpiece	200mm		
Max. weight of workpiece	30kg		
Operation system	Windows 7/8/10		
Drive method	automatic		
Power supply	AC 220V, 50/60Hz		
Dimension (L×W×H)	2035×1590×1720mm	2315×1590×1720mm	2315×1790×1720mm
Weight	2900kg	3200kg	4000kg



programmable segmented ring light (included)



lens with coaxial light (included)

STANDARD DELIVERY

Main unit	1 pc
Dongle	1 pc
Computer	1 pc
Software	1 pc
Display	1 pc
Lens with coaxial light	1 pc
Controller	1 pc
Calibration glass chart	1 pc
Laser positioner	1 pc
Clay	1 pc
Anti-dust cover	1 pc

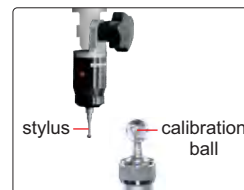

probe (optional), includes Ø2mm and Ø3mm styli, Ø25mm calibration ball, measuring accuracy is 10μm



laser probe (optional) measuring accuracy is 5μm

OPTIONAL ACCESSORY

0.5X auxiliary objective	code: ISD-V-OB05X working distance: 175mm magnification: 16.5~104.3X (on 24" monitor)
2X auxiliary objective	code: ISD-V-OB2X working distance: 36mm magnification: 66~417.2X (on 24" monitor)
Probe	code: ISD-V-PROBE includes Ø2mm and Ø3mm styli, Ø25mm calibration ball
Laser probe	code: ISD-V-LASER
Office software	code: 7313-OFFICE

VISION MEASURING SOFTWARE

SOFTWARE FOR VISION MEASURING SYSTEMS
 ISD-V SERIES, ISD-H SERIES, ISD-VMM SERIES,
 ISD-E SERIES AND VMM-L SERIES

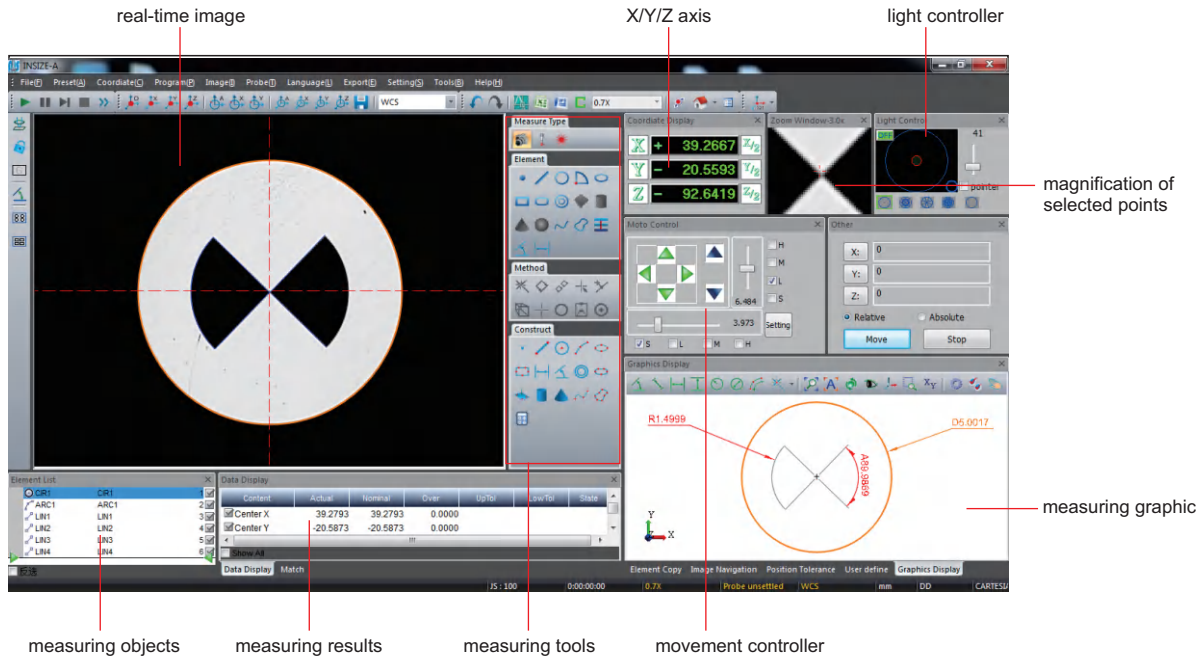

- Operation system: Windows 7/10
- Language: English
- Control features: assistant focus (manual machines), auto focus (CNC machines), auxiliary light control, motion controlled by mouse (CNC machines), auto zoom lens (CNC machines)
- Image measuring methods: intelligent automatic edge detect, select points of an area, select points from multiple parts, select points via mouse, select adjacent points, select points via cross line, magnify to select points, comparatively select points, select points via probe, edge point, contour point
- Constructable elements: point, line, circle, arc, ellipse, rectangle, distance, angle, ring, slot, plane, cone, open curve, closed curve
- Support fixture (CNC machines), scanning, image navigation, user define, pixel calibration
- Measuring by image and probe, image and probe can be synchronized
- Measuring data can be sent to Excel, Word, SPC, measuring elements can be sent to dxf

■ Dimension measuring tools:

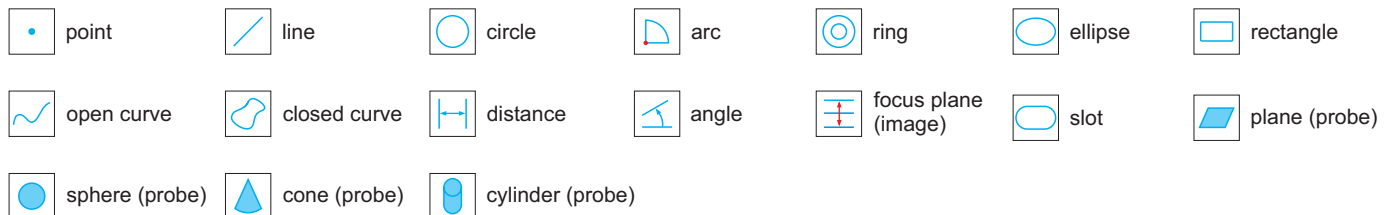

■ Geometric measuring tools:

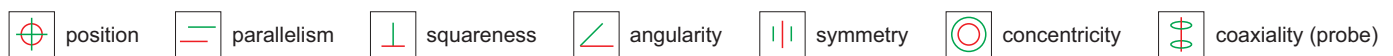

To be continued

Continued from previous page

Measuring and element construct methods:

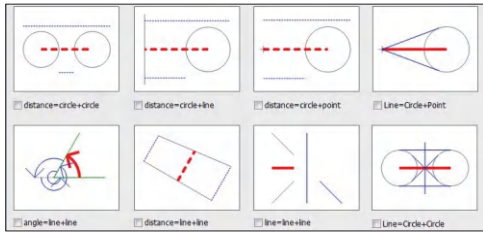

Sent to CAD, EXCEL, WORD

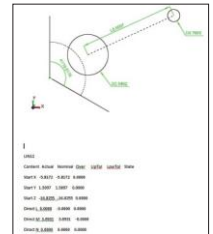
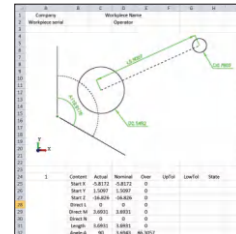
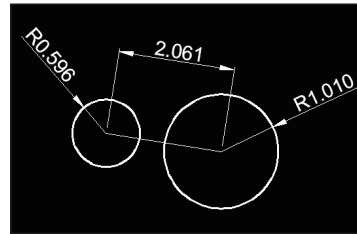

CAD

EXCEL

WORD

Edge-detection:

point tool

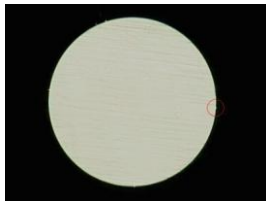

box tool

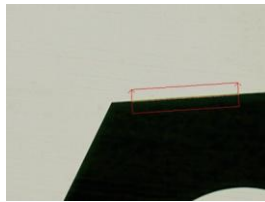

circle tool

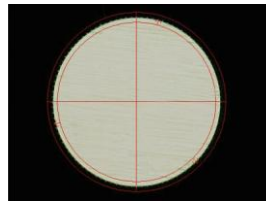

Contour scanning:

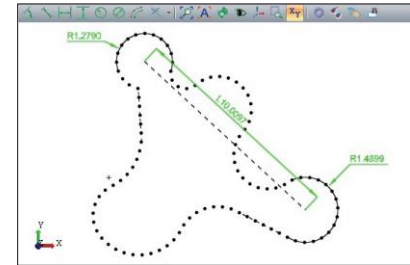

CAD measuring:

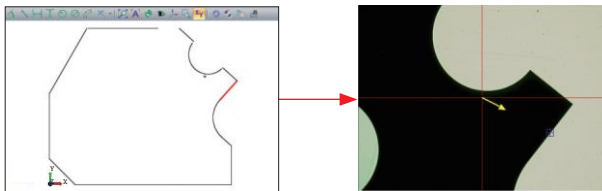

import CAD drawing, set the datum, establish coordinate system, then the software will automatically measure

CAD comparison:

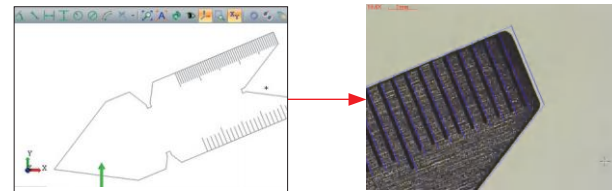

import CAD drawing, then compare with real-time image

Profile scanning:



SPC analysis, import the measuring data to SPC module, generate Xbar-R chart, Xbar-S chart, Mid-R chart, X-Rs chart, Histogram, Sigma A and Sigma S chart, Cpk process chart, Process state analyse chart, Single process advice analyse chart

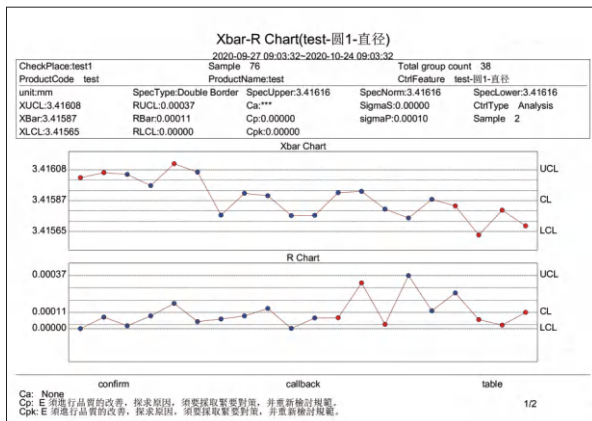

Xbar-R chart

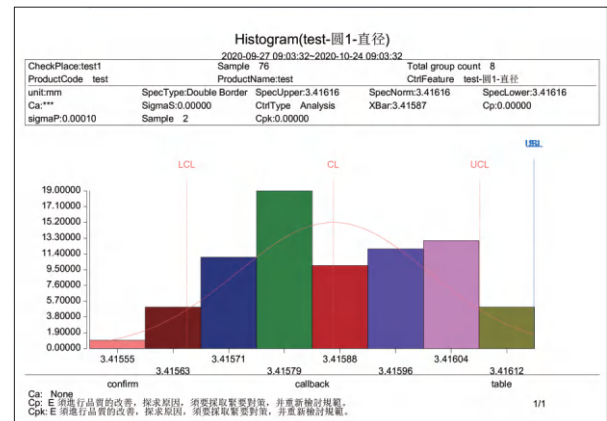

Histogram

113-PIECE JIG SET FOR VISION MEASURING SYSTEMS CODE ISY-700

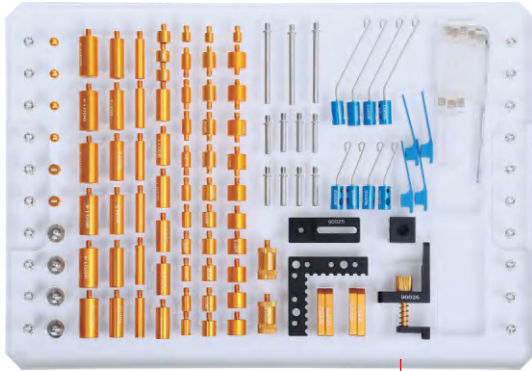



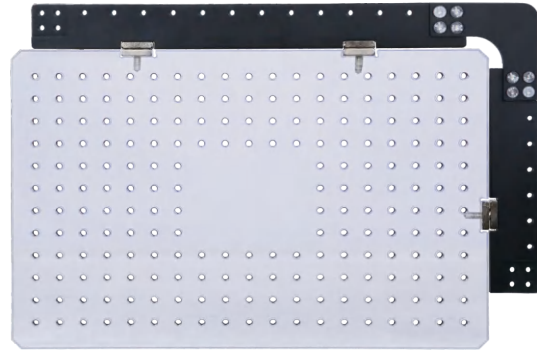





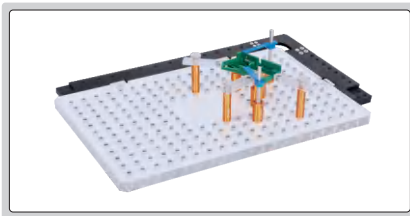

acrylic tray (included)

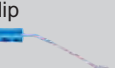

ISY-700

application example



Product	Code	Size (mm)	Quantity
clip 	ISY-700-90001	7×34	4
clip 	ISY-700-90002	Ø1.5×24	4
	ISY-700-90003	Ø1.5×50	4
clip stand 	ISY-700-90004	Ø4×20	8
	ISY-700-90005	Ø4×46	3
spherical support head 	ISY-700-90006	—	4
stand 	ISY-700-90007	Ø6×10	6
	ISY-700-90008	Ø6×25	6
	ISY-700-90019	Ø6×5	3
stand 	ISY-700-90009	Ø9×7	3
	ISY-700-90010	Ø9×10	6
	ISY-700-90011	Ø9×20	6
	ISY-700-90012	Ø9×25	6
stand 	ISY-700-90013	Ø12×10	6
	ISY-700-90014	Ø12×25	6
stand for slice parts 	ISY-700-90015	Ø6×10	4
	ISY-700-90016	Ø9×10	4
	ISY-700-90017	Ø12×10	4
stand with fine adjustment 	ISY-700-90018	Ø12×20~25	2

Product	Code	Size (mm)	Quantity
adapter for square support 	ISY-700-90020	—	2
clamping screw 	ISY-700-90021	—	4
L-shaped positioning plate 	ISY-700-90022	50×50×6	1
sliding support plate 	ISY-700-90023	30×12×5	4
square support 	ISY-700-90024	20×16×16	1
base for square support 	ISY-700-90025	45×16×6	1
spring stand 	ISY-700-90026	—	1
acrylic sliding support plate 	ISY-700-90028	45×12×5	8
wrench 	ISY-700-90029	M3	1
acrylic base plate 	ISY-700-90030	300×200×12 Hole size: M4X0.7	1

STANDARD GLASS SCALES



ISD-CL300A

- To calibrate optical measuring instruments, also can be used as optical positioning elements in precision machine tools

STANDARD TYPE

Code	Measuring range	Graduation	Length	Width	Thickness	Accuracy
ISD-CL100A	100mm	1mm	130mm	30mm	5mm	1 μ m
ISD-CL200A	200mm	1mm	230mm	30mm	5mm	1 μ m
ISD-CL300A	300mm	1mm	330mm	30mm	5mm	1 μ m
ISD-CL400A	400mm	1mm	430mm	30mm	5mm	1 μ m
ISD-CL500A	500mm	1mm	530mm	30mm	5mm	2 μ m

ECONOMIC TYPE

Code	Measuring range	Graduation	Length	Width	Thickness	Accuracy
ISD-CL100B	100mm	1mm	130mm	30mm	5mm	3 μ m
ISD-CL200B	200mm	1mm	230mm	30mm	5mm	3 μ m
ISD-CL300B	300mm	1mm	330mm	30mm	5mm	3 μ m
ISD-CL400B	400mm	1mm	430mm	30mm	5mm	3 μ m
ISD-CL500B	500mm	1mm	530mm	30mm	5mm	3 μ m

ADVANCED TYPE (The scale is between two layers of glass and will not be worn off)

Code	Measuring range	Graduation	Length	Width	Thickness	Accuracy
ISD-CL100S	100mm	1mm	130mm	30mm	10mm	1 μ m
ISD-CL200S	200mm	1mm	230mm	30mm	10mm	1.5 μ m
ISD-CL300S	300mm	1mm	330mm	30mm	15mm	2.5 μ m
ISD-CL400S	400mm	1mm	430mm	30mm	15mm	3 μ m
ISD-CL500S	500mm	1mm	530mm	30mm	15-25mm	3.5 μ m



Tool Presetters
Page 676-683



Cutting Tools Microscopes
Page 684

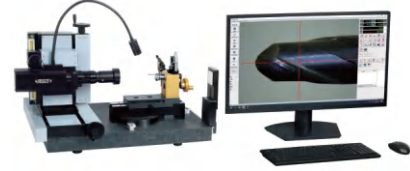

Cutting Tools Vision Measuring Systems
Page 685-686



Shank Runout Testers
Page 687



CHECK, PRESET AND MEASURE CUTTING TOOLS

AUTOMATIC RECOGNITION OF CUTTING EDGE SHAPES

DATA OUTPUT

TOOL PRESETTER CODE ISP-A350

INSIZE PLUS
MADE IN EUROPE

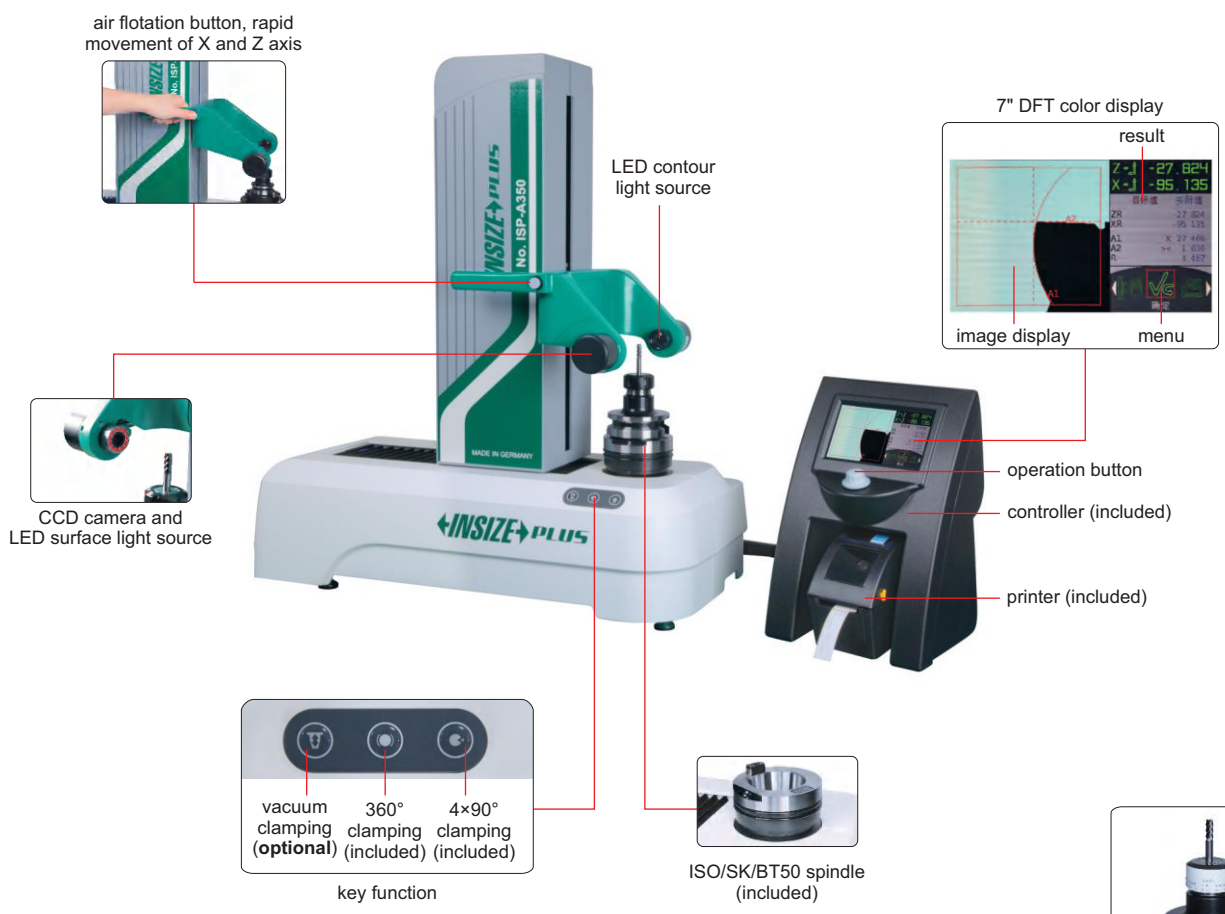

- Check, preset and measure cutting tools
- Telecentric lens CCD camera system
- Use Bosch or Festo pneumatic components, THK guide ways and HEIDENHAIN scales
- Built-in 104 cutting edge shapes, automatic recognition
- Measuring modes: absolute, relative and incremental measurement
- Measuring radius, angle, concentricity, axial runout, etc.
- Storage of 1000 tool parameters
- View, print and export measurement results

STANDARD DELIVERY

Main unit	1 pc
Controller	1 pc
ISO/SK/BT50 spindle (including 360° clamping and 4×90° clamping)	1 pc
Printer	1 pc
Printer label paper	1 pc



attach the printed label on the tool



ISO/SK/BT50 to HSK63 A/C/E, HSK80 B/D/F converter (optional)



ISO/SK/BT50 to ISO/SK/BT40 converter (optional)

To be continued

Continued from previous page

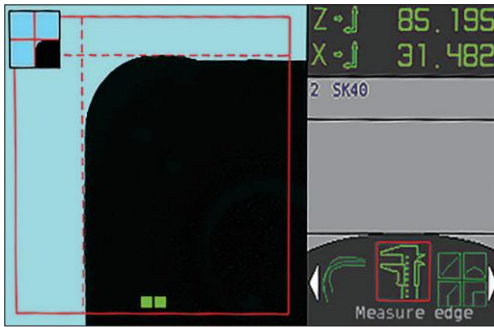

automatic recognition of cutting edge shapes

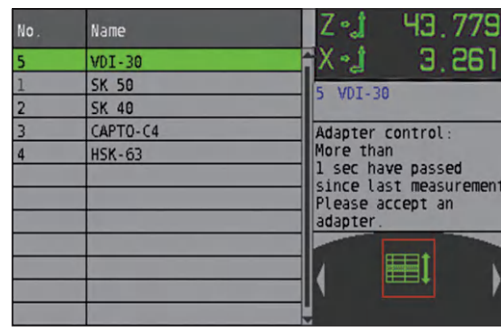

can store 99 sets of converter parameters and automatically prompt to check the zero position at fixed time

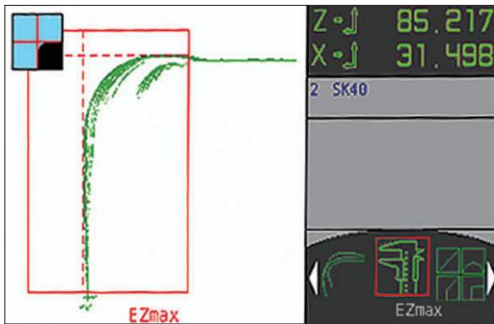

scan and measure the maximum profile of the cutting tool



check cutting edge wear

SPECIFICATION

Maximum tool diameter (X axis)	320mm	
Maximum tool height (Z axis)	350mm	
Repeatability	X axis	2 μ m
	Z axis	2 μ m
X/Z axis resolution	1 μ m	
Camera	color CCD	
Image processing accuracy	1 μ m	
Magnification	12X	
View field	7 \times 7mm	
Illumination	adjustable LED light	
Spindle	ISO/SK/BT50 (concentricity 2 μ m)	
Data output	USB, RS232	
Working air pressure	0.6~0.8MPa	
Environmental requirement	temperature: 5~35 $^{\circ}$ C	
	relative humidity: 10%~95%	
Power supply	100~240V, 50/60Hz	
Dimension (L \times W \times H)	1200 \times 400 \times 870mm	
Weight	80kg	

23

OPTIONAL ACCESSORY

ISO/SK/BT50 to ISO/SK/BT40 converter	ISP-A350-C1
ISO/SK/BT50 to ISO/SK/BT30 converter	ISP-A350-C5
ISO/SK/BT50 to HSK63 A/C/E, HSK80 B/D/F converter	ISP-A350-C2
ISO/SK/BT50 to HSK50 A/C/E, HSK63 B/D/F converter	ISP-A350-C3
ISO/SK/BT50 to HSK40 A/C/E, HSK50 B/D/F converter	ISP-A350-C4
ISO/SK/BT50 to HSK32 A/C/E, HSK40 B/D/F converter	ISP-A350-C6
Spindle vacuum clamping	ISP-A350-VC
Printer label paper	ISP-A350-TAB

CHECK, PRESET AND MEASURE CUTTING TOOLS

AUTOMATIC RECOGNITION OF CUTTING EDGE SHAPES

DATA OUTPUT



**TOOL PRESETTER
CODE ISP-B420**
INSIZE PLUS
MADE IN EUROPE



- Windows 10 operation system
- Check, preset and measure cutting tools
- Telecentric lens CCD camera system
- Use Bosch or Festo pneumatic components, THK guideways and HEIDENHAIN scales
- Built-in 113 cutting edge shapes, automatic recognition
- Measuring modes: absolute, relative and incremental measurement
- Measuring radius, angle, concentricity, axial runout, etc.
- Storage of 3000 tool parameters
- View, print and export measurement results



attach the printed label on the tool

To be continued

Continued from previous page

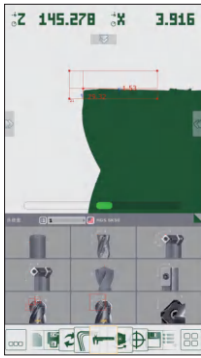

fast measurement, automatic recognition of cutting edge shapes

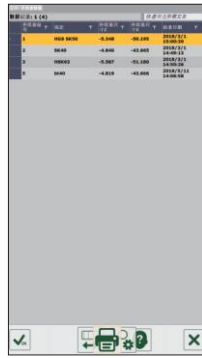

can store 99 sets of converter parameters and automatically prompt to check the zero position at fixed time

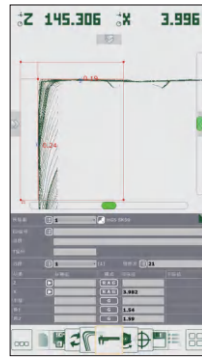

scan and measure the maximum profile of the tool



check cutting edge wear

SPECIFICATION

Maximum tool diameter (X axis)	420mm	
Maximum tool height (Z axis)	420mm	
Range of snap gauge (X axis)	100mm	
Repeatability	X axis	2μm
	Z axis	2μm
X/Z axis resolution	1μm	
Camera	color CCD	
Image processing accuracy	1μm	
Magnification	20X	
View field	7×7mm	
Illumination	adjustable LED light	
Spindle	ISO/SK/BT50 (concentricity 2μm)	
Data output	USB, RS232	
Working air pressure	0.6~0.8MPa	
Environmental requirement	temperature: 5~35°C	
	relative humidity: 10%~95%	
Power supply	110/220V, 50/60Hz	
Dimension (L×W×H)	1900×750×1750mm	
Weight	274kg	



ISO/SK/BT50 to HSK63 A/C/E, HSK80 B/D/F converter (optional)



ISO/SK/BT50 to ISO/SK/BT40 converter (optional)

STANDARD DELIVERY

Main unit	1 pc
Controller	1 pc
Bracket for tools and converters	1 pc
ISO/SK/BT50 spindle (including 360° clamping and 4×90° clamping)	1 pc
Printer	1 pc
Printer label paper	1 pc

OPTIONAL ACCESSORY

ISO/SK/BT50 to ISO/SK/BT40 converter	ISP-A350-C1
ISO/SK/BT50 to ISO/SK/BT30 converter	ISP-A350-C5
ISO/SK/BT50 to HSK63 A/C/E, HSK80 B/D/F converter	ISP-A350-C2
ISO/SK/BT50 to HSK50 A/C/E, HSK63 B/D/F converter	ISP-A350-C3
ISO/SK/BT50 to HSK40 A/C/E, HSK50 B/D/F converter	ISP-A350-C4
ISO/SK/BT50 to HSK32 A/C/E, HSK40 B/D/F converter	ISP-A350-C6
Spindle vacuum clamping	ISP-A350-VC
Printer label paper	ISP-A350-TAB

CHECK, PRESET AND MEASURE CUTTING TOOLS



VIDEO

ASSISTED BLADE ALIGNMENT

DATA OUTPUT

TOOL PRESETTER CODE TLP-C500

- Check, preset and measure cutting tools
- CCD camera system with telecentric lens
- Touch screen, shortcut icons for easy operation
- Granite platform, more stable
- Measuring lines, arcs, angles and other elements quickly
- Pictures can be saved
- Measuring modes: absolute, relative and incremental measurement
- Measuring reports can be printed
- Supporting system scanning for direct retrieval and communication with tools machine
- Automatic cutting tools recognition by scanner

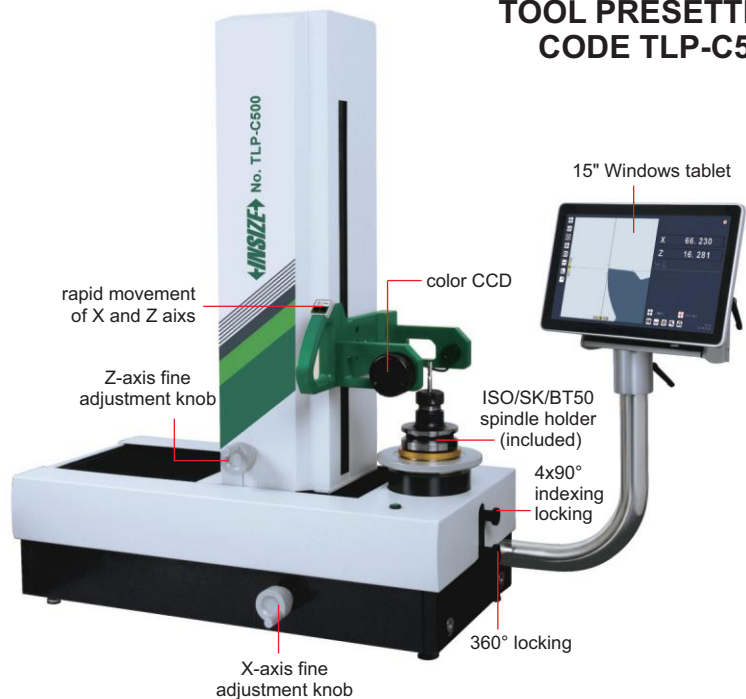

SPECIFICATION

Maximum tool diameter (X axis)	400mm	
Maximum tool height (Z axis)	500mm	
Repeatability	X axis	2μm
	Z axis	2μm
Resolution of X/Z axis	1μm	
Radial runout of spindle	≤2μm at 100mm, ≤5μm at 300mm	
Camera	color CCD, 1.3M pixel	
Magnification	26X	
View field	6.5x6.5mm	
Illumination	LED transmitted light source	
Spindle	ISO/SK/BT50	
Output	USB	
Air pressure	0.4~0.6MPa	
Environment requirement	temperature:10~45°C,relative humidity: 30%~75%	
Power supply	220V	
Dimension (L×W×H)	860×590×1060mm	
Weight	120kg	

STANDARD DELIVERY

Main unit	1 pc
Tablet computer	1 pc
ISO/SK/BT50 spindle (including 4×90° indexing and 360°locking)	1 pc
Anti-dust cover	1 pc

OPTIONAL ACCESSORY

ISO/SK/BT50 to ISO/SK/BT30 converter	TLP-C500-C1
ISO/SK/BT50 to ISO/SK/BT40 converter	TLP-C500-C2
ISO/SK/BT50 to HSK32 A/C/E, HSK40 B/D/F converter	TLP-C500-C3
ISO/SK/BT50 to HSK40 A/C/E, HSK50 B/D/F converter	TLP-C500-C4
ISO/SK/BT50 to HSK50 A/C/E, HSK63 B/D/F converter	TLP-C500-C5
ISO/SK/BT50 to HSK63 A/C/E, HSK80 B/D/F converter	TLP-C500-C6
Spindle vacuum clamping function	TLP-C500-VB
Printer	TLP-C500-PRINTER
Standard rod	TLP-C500-ROD
Scanner	TLP-C500-SCANNER
Tool table	TLP-C500-TABLE
Ring LED light	TLP-C500-LED

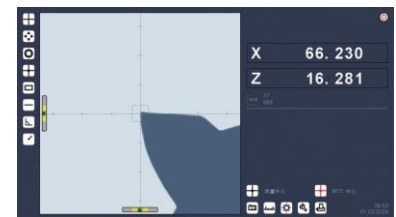

checking blade geometry quickly

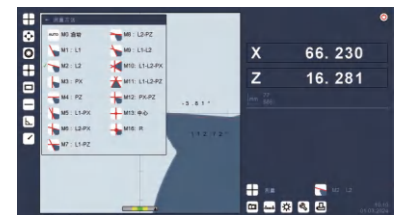

multiple measurement methods can be chosen

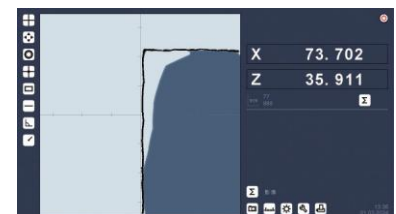

scanning the maximum profile of cutting tools



dynamic crosshair automatically adjusting as X and Z axes move, and the cutting tools can be quickly measured through the dynamic crosshair

TOOL PRESETTER (PROJECTOR TYPE) CODE TLP-P340B



projection screen Ø120mm with scale
(protractor with 1° graduation, radius with 0.2,
0.4, 0.8, 1.2, 1.5, 2, 2.5, 3mm graduation)

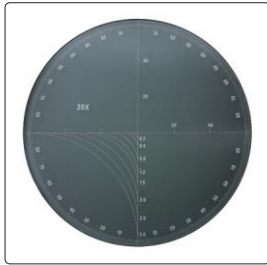

20X lens



illumination

BT50 spindle

spindle rotation
hand wheel



air flotation button, rapid
movement of X and Z axis

Z-axis fine
adjustment knob

X-axis fine
adjustment knob

foot-switch



standard rod (included)



BT50/BT40 converter (optional)



BT50/BT30 converter (optional)

SPECIFICATION

Maximum tool diameter (X axis)		Ø300mm
Height measuring range (Z axis)		45~450mm
Accuracy	X axis	±6µm
	Z axis	±13µm
Resolution		0.5µm
Diameter of projection screen		Ø120mm
Lens	magnification	20X
	view filed	Ø6mm
Illumination		3W LED
Spindle holder		BT50
Working air pressure		0.6MPa
Power supply		110/220V, 50/60Hz
Dimension (L×W×H)		690×620×922mm
Weight		160kg

STANDARD DELIVERY

Main unit	1 pc
BT50 spindle holder	1 pc
Standard rod	1 pc
Foot-switch	1 pc
Anti-dust cover	1 pc

OPTIONAL ACCESSORY

BT50/BT30 converter	TLP-P340B-C1
BT30 rod	TLP-P340B-R1
BT50/BT40 converter	TLP-P340B-C2
BT40 rod	TLP-P340B-R2
Printer	TLP-P340B-PRINTER



rotate the handwheel

rotate the handwheel to rotate tools



digital readout

Z axis dial indicator

X axis dial indicator

BT50 spindle holder

Z axis moving handlewheel

Z axis quick moving knob

X axis quick moving knob

X axis moving handlewheel

TLP-400E

standard rod (included)



BT50/BT40 converter (optional)



BT50/BT30 converter (optional)

- Absolute linear scales, zero setting is not needed after power on and off

SPECIFICATION

Code	TLP-400E	TLP-400EP
Printer	not included	included
Maximum tool diameter (X axis)	Ø300mm	
Height measuring range	60~400mm	
Repeatability	0.005mm	
Measuring accuracy	0.01mm	
Linear scale resolution	0.001mm	
Dial indicator graduation	0.001mm	
Spindle holder	BT50	
Power supply	110/220V, 50/60Hz	
Dimension (L×W×H)	720×480×930mm	
Weight	150kg	

STANDARD DELIVERY

Main unit	1 pc
BT50 spindle holder	1 pc
Standard rod	1 pc
Dial indicator	2 pcs
Wrench	1 set
Anti-dust cover	1 pc

OPTIONAL ACCESSORY

BT50/BT30 converter	TLP-300H-C1
BT50/BT40 converter	TLP-300H-C2

TOOL PRESETTERS (BASIC TYPE)



TLP-300H



standard rod (included)



BT50/BT40 converter (optional)



BT50/BT30 converter (optional)

- Absolute linear scales, zero setting is not needed after power on and off

SPECIFICATION

Code	TLP-300H	TLP-300HP
Printer	not included	included
Maximum tool diameter (X axis)	Ø300mm	
Height measuring range	60~300mm	
Repeatability	0.005mm	
Measuring accuracy	0.02mm	
Linear scale resolution	0.005mm	
Dial indicator graduation	0.01mm	
Spindle holder	BT50	
Power supply	110/220V, 50/60Hz	
Dimension (L×W×H)	600×365×690mm	
Weight	68kg	

STANDARD DELIVERY

Main unit	1 pc
BT50 spindle holder	1 pc
Standard rod	1 pc
Dial indicator	2 pcs
Wrench	1 set
Anti-dust cover	1 pc

OPTIONAL ACCESSORY

BT50/BT30 converter	TLP-300H-C1
BT50/BT40 converter	TLP-300H-C2

TAKE PICTURES AND VIDEOS

BUILT-IN SOFTWARE WITHOUT COMPUTER

SPLIT SCREEN DESIGN

CUTTING TOOLS MICROSCOPE CODE ISM-CT820

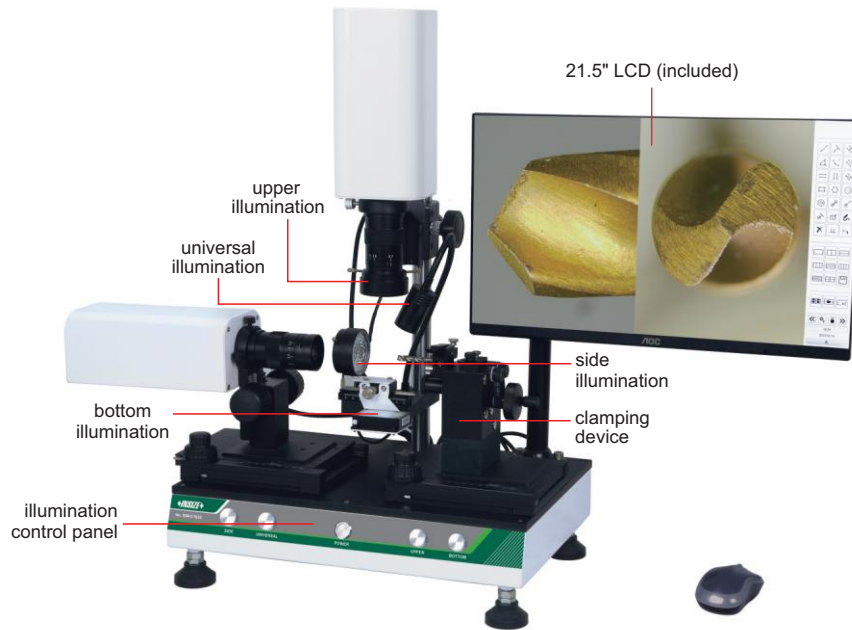

glass calibration plate (included)

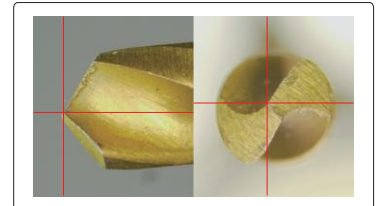

display cross hairs separately (movable)

- Split screen design, zoom in and out independently
- One mouse can operate two cameras
- Display cross hairs
- Brightness, contrast ratio, white balance are adjustable
- Basic measuring tools including point to point, point to line, line to line, angle, three-point circle, etc.

SPECIFICATION

Cutting tools range	Ø4~12mm, length 30-75mm
Lens	step-zoom lens
Output	HDMI
Resolution	1920×1080
Frame rate	60fps
Focus distance	85mm
View field	2×3.5~13.2×23.9mm
Magnification	20-132X
Power supply	AC 100-240V
Dimension (L×W×H)	450×300×700mm
Weight	20kg

STANDARD DELIVERY

Main unit	1 pc
Display	1 pc
32G USB flash disk	1 pc
Mouse	1 pc
HDMI cable	1 pc
Glass calibration plate	1 pc
Anti-dust cover	1 pc

SOFTWARE (INCLUDED)

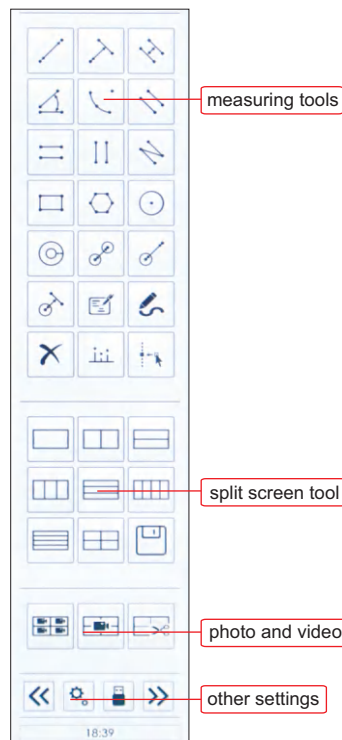

screen display

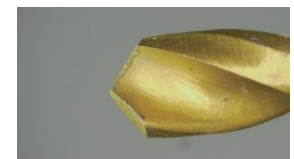

single screen display

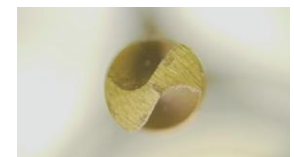

single screen display

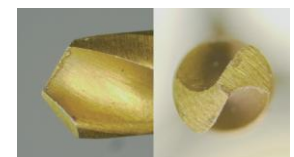

split screen display

CUTTING TOOLS VISION MEASURING SYSTEM CODE TLP-D150

CAD COMPARISON

SCAN MAXIMUM
PROFILE

CUTTING TOOLS
MEASUREMENT

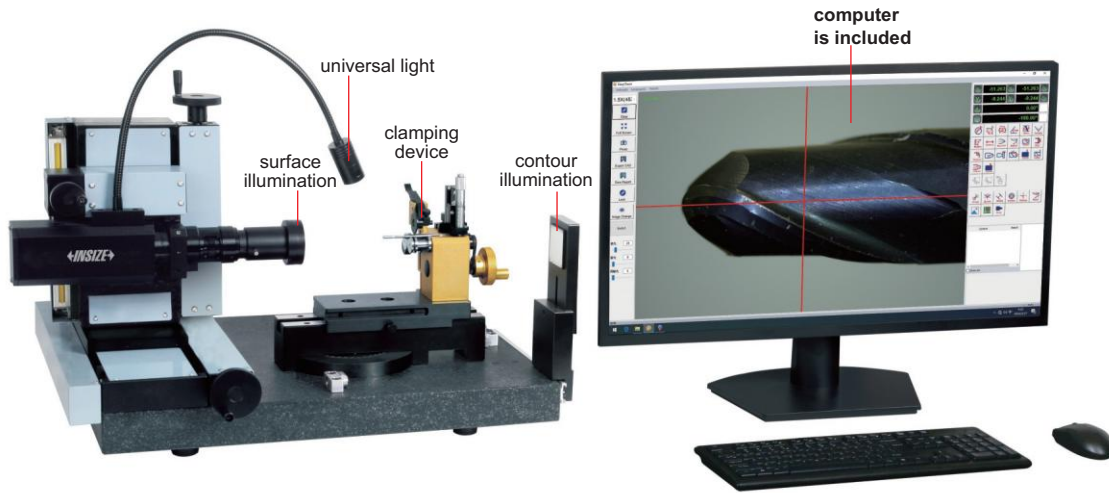

measurement items

Drill bit:

helical angle bandwidth, back of blade, angle of main cutting edge in front, in back, back angle, top angle, cross angle, cross width, feed angle of internal edgeretreat angle height difference, cross-edge runout, rear blade width, B value, C value, tip chamfer angle, tip width, feed radius, chipformer parameters, overall comparison of dxf on end face.

Milling cutter:

groove front angle, back angle, groove depth, core thickness, spiral angle, belt width, blade width, end edge 1st 2nd back angle, front angle of the end blade, long tooth overcenter, parameters of the end tooth chipformer, taper, radius, chamfer size, etc.

Tap:

measurement of chamfer, groove shape, leading and trailing angles, tooth angle, pitch, pitch diameter.

Blade:

using V-shaped fixtures for cross clamping or install on cylindrical tool holders to measure chamfers, back angles, and fillet sizes.

Reamer:

anterior angle, helix angle, core thickness, groove depth, belt width, chamfer, etc.

Gun drill inspection

Cutting edge wear inspection

Step length

Cutting edge end runout and trail runout

Tool profile comparison



concentric clamp (included)



V-clamp (included)

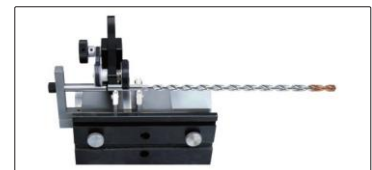

V-concentric clamp (optional)

23

- Measurement and inspection of milling cutters, drill bits, non-standard molding tools under surface light
- Profile measurement, automatic profile capture for straight and helical fluted tools
- Import and export CAD file
- High magnification for clear observation of tool chipping and grinding wheel pattern on the back face
- Granite platform, more stable
- Ergonomically designed structure, easy and quick to operate
- The crosshairs of the cutting edge can be automatically recognized and captured
- Automatic and manual measurements
- Data storage, analysis, management, photography, image storage and management

To be continued

Continued from previous page

SPECIFICATION

Measuring range (X×Y)	150×60mm
Applicable range	0~40mm
Resolution of X/Y axis	1μm
Accuracy of X/Y axis	5μm
Repeatability of X/Y axis	2μm
Objective	0.58X~8X (zoom)
View field (diagonal length)	2.0~29mm
Working distance	68mm
Magnification	20X~240X (on 27" monitor)
Camera	color CCD, 0.3M pixel
Illumination	surface and contour with adjustable LED, with universal light
Operation system	Windows 10
Drive method	manual
Power supply	110~220V, 50/60Hz
Dimension (L×W×H)	600×450×500mm
Weight	60kg

STANDARD DELIVERY

Main unit	1 pc
Computer	1 pc
Dongle	1 pc
Concentric clamp	1 pc
V-clamp	1 pc
Anti-dust cover	1 pc

OPTIONAL ACCESSORY

Cutter handle clamp	TLP-D150-C1
V-concentric clamp	TLP-D150-C2

SOFTWARE (INCLUDED)



SHANK RUNOUT TESTERS



4771-30

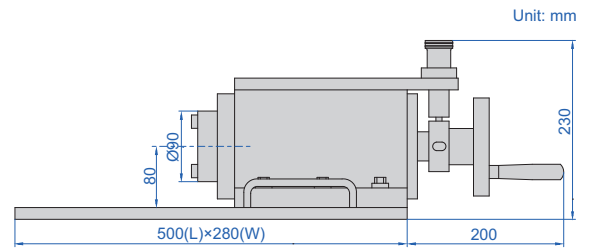

- Measure the radial runout of shanks, collets and cutting tools
- Optional accessory: dial test indicator, magnetic stand

Code	Taper	Accuracy
4771-30	BT30	1µm
4771-40	BT40	1µm
4771-50	BT50	1µm

standard shank (included)



measure radial runout of shank

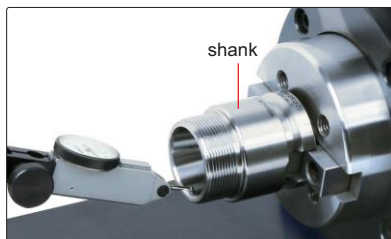

measure radial runout of collet

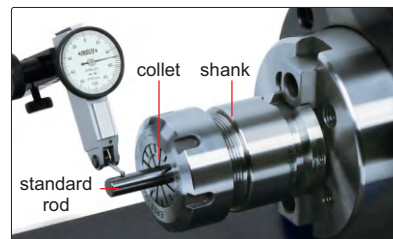

measure radial runout of cutter

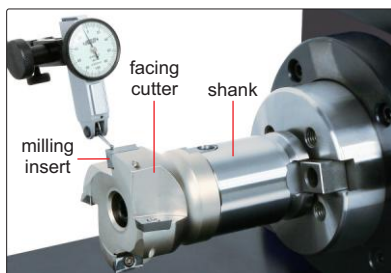

measure radial runout of end mill

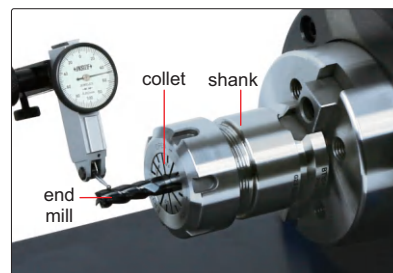



Large Depth Of Field 3D Measuring Microscopes
Page 689-692



Toolmaker Microscopes
Page 693-696



Digital Microscopes
Page 697-735



Metallurgical Microscopes
Page 736-740



Industrial Microscopes
Page 741-742



Zoom Stereo Microscopes
Page 743-748



Polarizing Microscopes
Page 750



Digital Cameras For Microscopes
Page 751-762

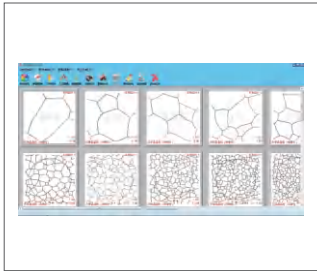

Metallurgical Analysis Softwares
Page 761-762



Portable Measuring Microscopes
Page 763



Table Magnifiers With Illumination
Page 764



Digital Magnifiers
Page 765-766



Magnifiers
Page 767-771



Telescoping Inspection Mirrors
Page 771



Telescoping Pick-up
Page 772

LARGE DEPTH OF FIELD 3D MEASURING MICROSCOPE (ADVANCED TYPE) CODE ISM-H5000

STEREOSCOPIC
3D IMAGING

IMAGE STITCHING

MOTORIZED
XYZ AXIS

2D/3D
MEASUREMENT

MAGNIFICATION
30-6000X

MOTORIZED
ZOOM LENS

MAP
NAVIGATION



side camera shows the relationship between the lens and the workpiece, reducing the risk of collision



computer (included)

- High definition telecentric imaging lens
- Auto focus
- 4 motorized switching objectives
- Split-screen display
- Rotatable stage
- Take picture and video
- Multiple illumination options for different products and scenarios
- Elimination of reflections and dark field halos, HDR, optical shadows
- Automatic stitching for large field view and measurement after stitching
- Measurements can be saved in reports and exported

STANDARD DELIVERY

Main unit	1 pc
Computer	1 pc
Glass calibration plate	1 pc
Anti-dust cover	1 pc
16G USB flash disk	1 pc

COMPUTER SOFTWARE (INCLUDED)

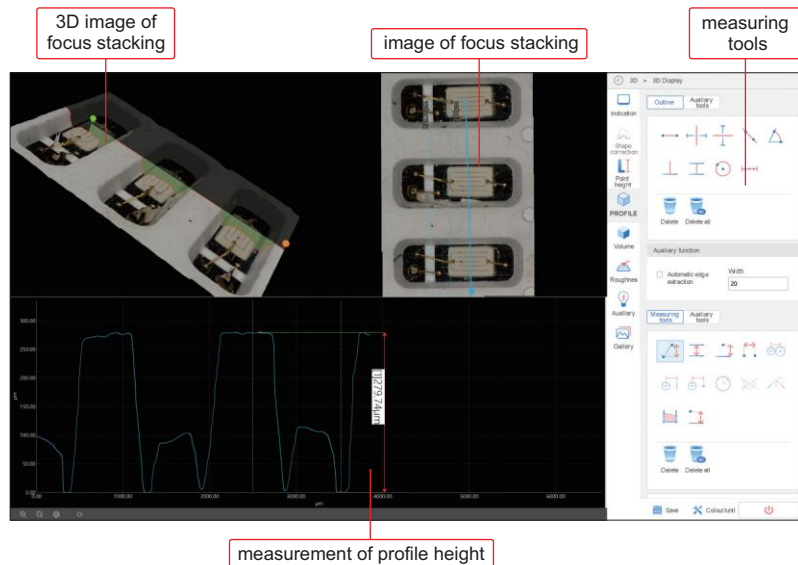

3D image of focus stacking

image of focus stacking

measuring tools

measurement of profile height

tiltable observation



To be continued



Continued from previous page

SPECIFICATION

Magnification	30X~6000X (30X, 40X, 50X, 80X, 100X, 150X, 200X, 300X, 300X, 400X, 500X, 700X, 1000X, 1500X, 2000X, 2500X, 4000X, 5000X, 6000X) 5000X and 6000X are digital magnification	
Objective	1.5X, 5X, 20X, 50X	
Horizontal resolution	0.42μm	
Maximum depth of field	30mm	
Working distance	2~30mm	
Max. height of workpieces	90mm	
View field	50.60×38.00μm~9977.30×7483.00μm	
Accuracy	±(0.5+0.005L)μm(L is measuring length or height in mm)	
Illumination	bright field (full/zoned), dark field (full/zoned), hybrid lighting, projected lighting	
Light source life	LED, lifespan about 40,000 hours	
Maximum viewable pixel size	2D: 5 billion pixels, 3D: 2.5 billion pixels	
Tilting angle range	-89°~+89°	
Camera	sensor	1/1.7"CMOS
	pixel	12.22M (4168×3062)
	frame rate	30fps
	resolution	quick: 2048×1536, standard: 2880×2160, high resolution: 4000×3000, high definition: 8000×6000/12000×9000
Display	size	27"
	screen size	596.736×335.664mm
	pixel pitching	0.1554×0.1554mm
	resolution	3840×2160
Motorized stage	movement axis	X/Y/θ axis
	range	40mm×40mm
	size	228mm×204mm
	moving speed	10mm/s
	resolution	1μm
	θ angle of rotation	-90°~+90
	max. weight of workpiece	5kg
Upper Z-axis	control mode	motorized
	moving speed	16.5mm/s
	resolution	0.1μm
	range	50mm
Lower Z-axis	control mode	motorized
	resolution	1μm
	moving speed	6mm/s
	range	50mm
Power supply	220V	
Dimension (L×W×H)	600×320×710mm	
Weight	70kg	

SOFTWARE FUNCTION

Imaging	2D imaging, 3D imaging
	adjustable elimination of reflection
	adjustable elimination of ring halos
	HDR, adjustable brightness/contrast/color difference
	optical shadow
	jitter correction
	2D stitching, 3D stitching
	fast 3D synthesis, high precision 3D synthesis
Measuring	chromatogram height
	stitching measurement
	plane measurement (distance/angle/radius/area, automatic edge detection, scale display)
File	3D measurement (point height/profile etc.)
	take and save pictures, videos
	export report to Excel

LARGE DEPTH OF FIELD 3D MEASURING MICROSCOPE CODE 5323-D215

STEREOSCOPIC
3D IMAGING

ROTATABLE
OBSERVATION

PROFILE HEIGHT
MEASUREMENT



- The Z-axis is driven by high precision stepping motor
- Can be connected to display and computer at the same time
- Fast generation of large depth of field images
- Plane measurement and profile height measurement

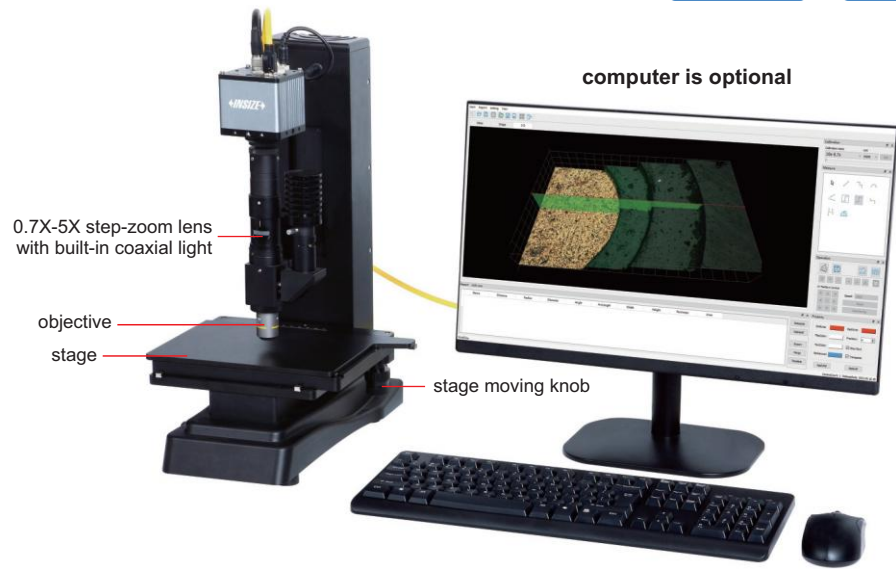

SPECIFICATION

Sensor	1/1.2" CMOS
Pixel	2M
Resolution	1920×1080
Magnification (10X objective)	142~970X (on 21.5" monitor)
Z-axis measurement range	30μm~6mm
View field (10X objective)	0.29×0.16~2.0×1.2mm
Working distance	11mm
Frame rate	30fps
Stage	size: 200×180mm travel: 200×180mm
Plane measuring accuracy	±5μm
Profile measuring accuracy *	±10μm
Output	HDMI/LAN
Power supply	power adapter
Dimension (L×W×H)	230×330×500mm
Weight	12.7kg

* During 3D synthesis, the number of photos should be not less than 150pcs in order to achieve this accuracy

STANDARD DELIVERY

Main unit	1 pc
10X objective	1 pc
1X objective	1 pc
Power adapter	1 pc
Calibration plate	1 pc
16G USB flash disk	1 pc

COMPUTER

Operation system	Win 10/11 (64 bits)
CPU	Intel Core 2 2.8GHz
Memory	16GB
LAN port	Gigabit Ethernet port

OPTIONAL ACCESSORY

5X objective	5323-D215-5X (working distance: 15mm)
20X objective	5323-D215-20X (working distance: 12mm)
50X objective	5323-D215-50X (working distance: 4mm)

SOFTWARE FOR COMPUTER (INCLUDED)

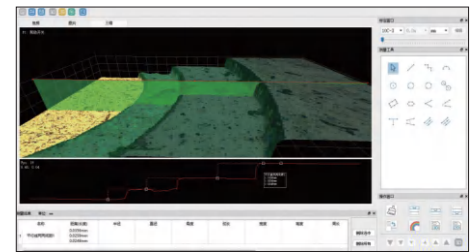

constructing stereoscopic 3D imaging that can be dragged and rotated for viewing, the cutting line can be dragged at any angle

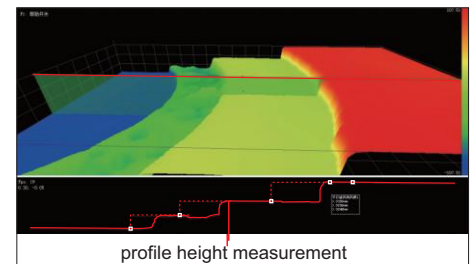

profile height measurement
the chromatogram height clearly shows the difference in three-dimensional height

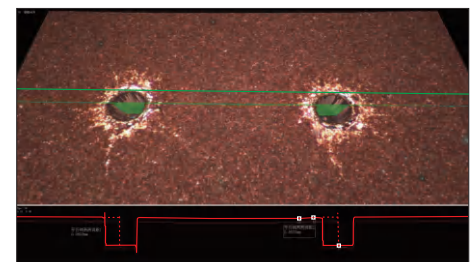

fast generation of large depth of field images

LARGE DEPTH OF FIELD 3D MEASURING MICROSCOPE CODE 5324-K210

AUTO FOCUS

BUILT-IN SOFTWARE
WITHOUT COMPUTER

STEREOSCOPIC
3D IMAGING

ROTATABLE
OBSERVATION

PLANE MEASUREMENT AND
PROFILE HEIGHT MEASUREMENT



- Auto focus camera
- Built-in motor, automatic focus stacking
- PDF report can be exported
- Fast generation of large depth of field images
- Plane measurement and profile height measurement

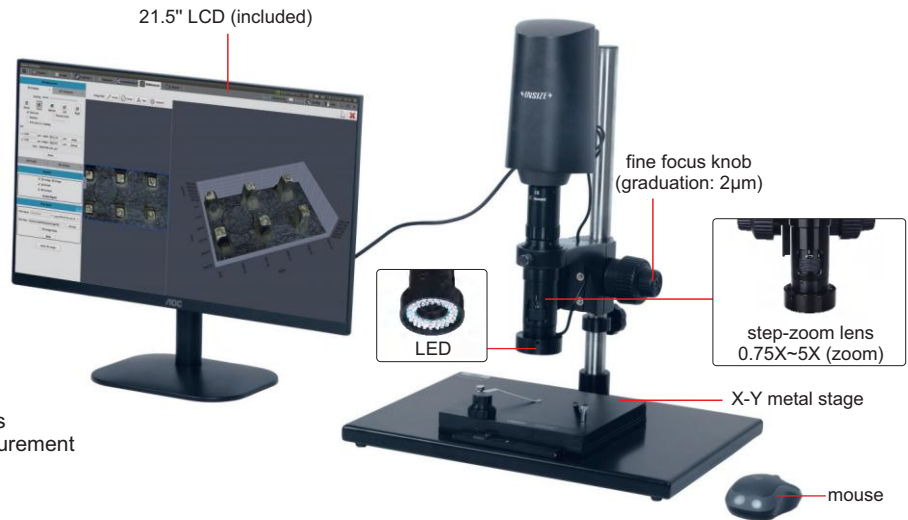

SPECIFICATION

Sensor	1/2" CMOS
Pixel	2M
Resolution	1920x1080
Magnification	100~750X
Z-axis measurement range	2mm
View field	0.6x0.32~4.5x2.5mm
Working distance	30~40mm
Frame rate	60fps
Plane measuring accuracy	±8μm
Output	HDMI/LAN
Power supply	power adapter
Dimension (L×W×H)	570×300×430mm
Weight	10kg

SOFTWARE (INCLUDED)

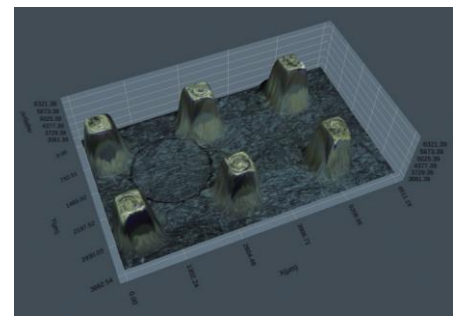

constructing stereoscopic 3D imaging that can be dragged and rotated for viewing

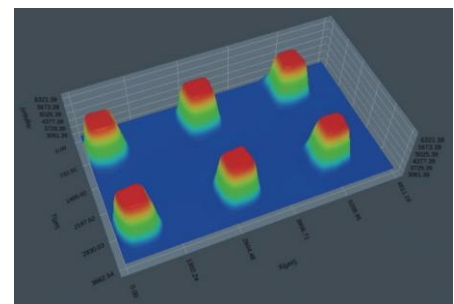

the chromatogram height clearly shows the difference in three-dimensional height

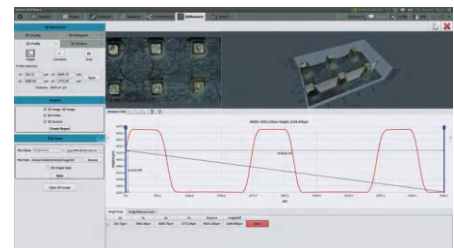

fast measurement of profile height difference

STANDARD DELIVERY

Main unit	1 pc
X-Y metal stage	1 pc
Mouse	1 pc
Keyboard	1 pc
Power adapter	3 pcs
Glass calibration ruler	1 pc
Calibration block	1 set
16G USB flash disk	1 pc

PROFILE HEIGHT MEASUREMENT ACCURACY

Objective magnification	Measuring range	Measuring accuracy
1.5X	2000μm	±20μm
2X	1200μm	±10μm
2.5X	800μm	±10μm
3X	600μm	±6μm
3.5X	400μm	±5μm
4X	320μm	±5μm
4.5X	250μm	±5μm
5X	200μm	±3μm

* Measurement of profile height at 0.75X and 1X is not recommended

TOOLMAKER MICROSCOPES

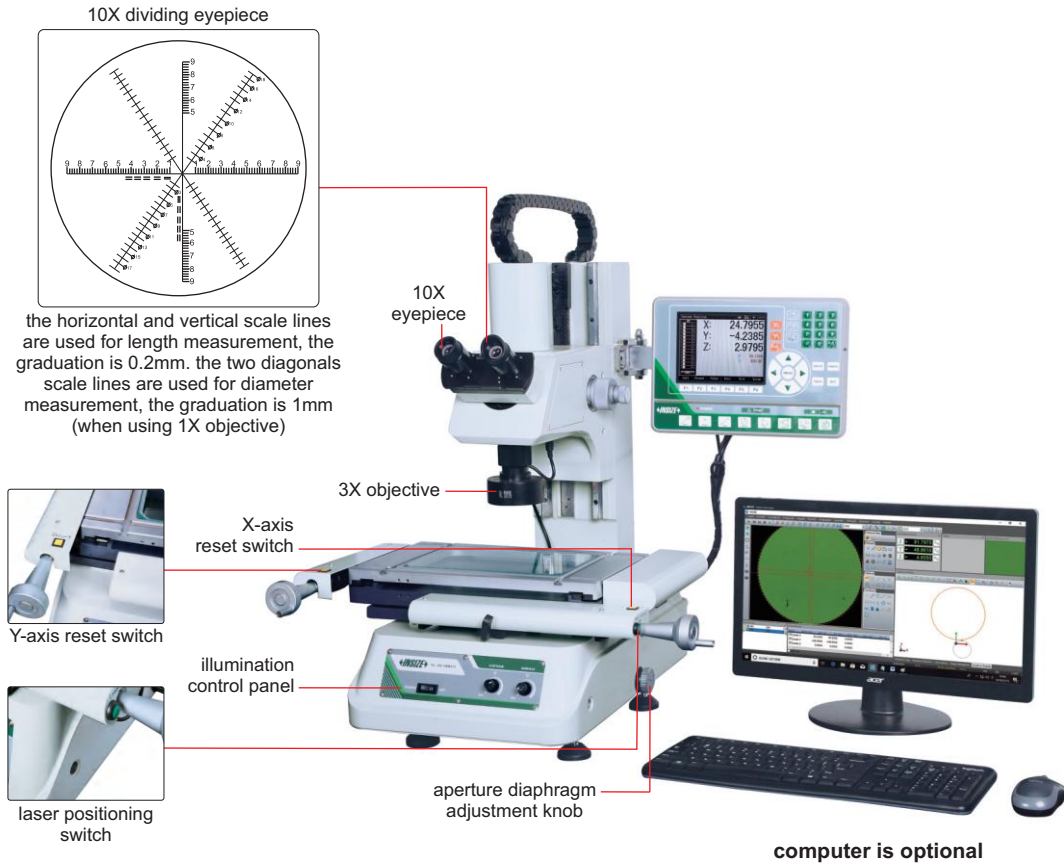

ISD-VMM215

SPECIFICATION

Code	binocular	ISD-VMM205	ISD-VMM215	ISD-VMM225	ISD-VMM235
	monocular	ISD-VMM205D	ISD-VMM215D	ISD-VMM225D	ISD-VMM235D
X/Y axis travel		150×100mm	200×100mm	250×150mm	300×200mm
Z axis travel		150mm	150mm	200mm	200mm
Metal stage size		354×228mm	404×228mm	450×280mm	500×330mm
Glass stage size		210×160mm	260×160mm	306×196mm	350×250mm
Resolution of X/Y/Z axis		0.5μm			
Accuracy of X/Y axis		≤(3.5+L/100)μm (L is the measuring length in mm)			
Repeatability		2μm			
Camera		1/3" color CCD, 0.3M pixel			
Optical magnification		30X (with 3X objective)			
Image magnification		114X (on 19" monitor)			
Illumination		surface and contour with adjustable LED			
Max. weight of workpiece		25kg			
Power supply		100V~240V, 50/60Hz			
Operation system		Windows 7/8/10			
Drive method		manual			
Dimension (L×W×H)		540×667×850mm	540×667×850mm	800×675×920mm	800×675×920mm
Weight		100kg	110kg	135kg	140kg

To be continued

Continued from previous page

DATA PROCESSING UNIT

Output	RS232
Function	simple measuring tools
	measure coordinate of points
	measure lines
	measure center coordinate, radius of circle with three points
	measure distances between two objects
	measure angles
	set origin of coordinate
	skew and calibrate the workpiece
	measure rectangle (including length, width, perimeter and center coordinate)
	measure thread (including thread diameter, screw pitch, screw angle)
	measure slot (including center coordinate, length, width)

STANDARD DELIVERY

Main unit	1 pc
Video card with dongle	1 pc
Software disc	1 pc
Calibration glass chart	1 pc
Demo sample	1 pc
Foot switch	1 pc
3X objective	1 pc

OPTIONAL ACCESSORY

1X objective	ISD-VMM-LENS1X
5X objective	ISD-VMM-LENS5X
10X objective	ISD-VMM-LENS10X
Toolmaker microscopes (with computer)	code: ISD-VMM205A (binocular) ISD-VMM215A (binocular) ISD-VMM225A (binocular) ISD-VMM235A (binocular)
	code: ISD-VMM205DA (monocular) ISD-VMM215DA (monocular) ISD-VMM225DA (monocular) ISD-VMM235DA (monocular)

SOFTWARE (INCLUDED)

- Refer to page 671~672 for details

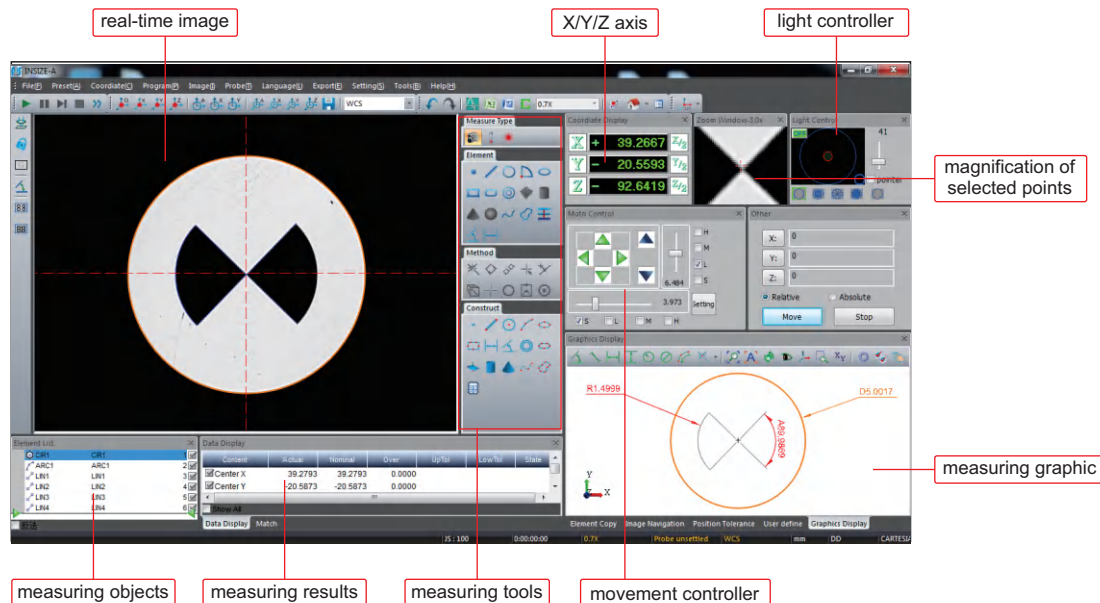

HIGH MAGNIFICATION TOOLMAKER MEASURING MICROSCOPES (ADVANCED TYPE)

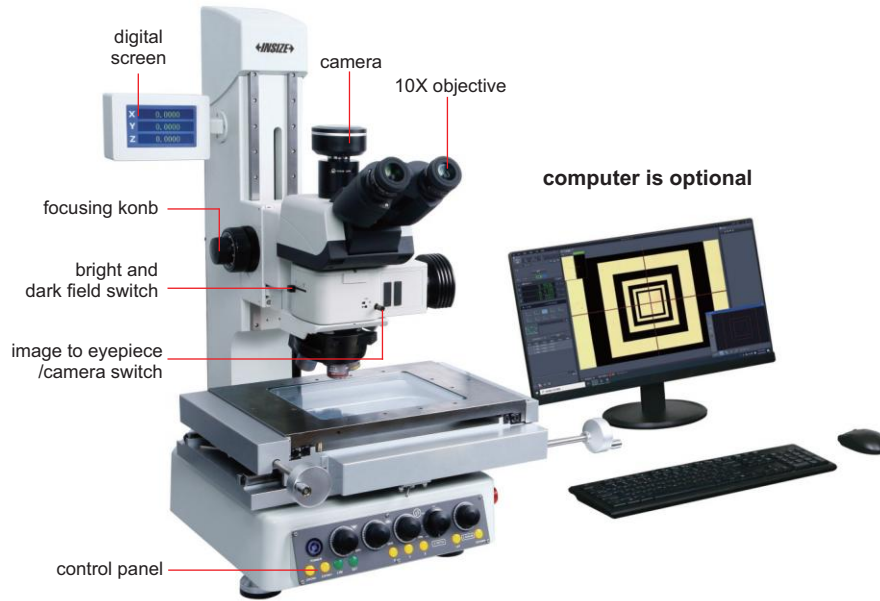

ISD-TM215

- For precision measurement and observation of industrial devices
- ECGO infinite chromatic aberration correction optical system
- High-density super power white LED chip array, high color rendering index, long life
- High precision linear scales
- Adopting motorized objective lens switching and supporting light intensity management
- Motorized Z-axis and focusing assist are included
- Measuring software is included, in-field image direct measurement, quick reading, out of image measurement for large workpieces, accurate measurement through image point selection, vectorlayer construction

SPECIFICATION

Code	ISD-TM215	ISD-TM320	ISD-TM330	ISD-TM430
X/Y axis travel	200×150mm	300×200mm	300×300mm	400×300mm
Metal stage size	400×280mm	500×350mm	500×450mm	600×450mm
Glass stage size	245×192mm	350×250mm	350×300mm	450×300mm
Z axis travel	210mm			
Z axis drive method	manual coarse and fine adjustment, motorized coarse and fine adjustment			
Resolution of X/Y/Z axis	0.1μm			
Accuracy of X/Y axis	≤(2.5+L/50)μm (L is the measuring length in mm)			
Repeatability of X/Y axis	2μm			
Optical magnification	50X~500X (up to 1000X with optional 100X objective)			
Digital magnification	150X~1500X (on 23.8" monitor), up to 3000X with optional 100X objective			
Eyepiece	large field SWH10X-H (view field: 25mm, adjustable visibility), with crossline			
Illumination	critical/kohler illumination, supporting bright field, polarized light, dark field and other lighting methods			
Observation tube	15~45° adjustable, inverse image, distance adjustable: 45~78mm, 0/100, 100/0 binocular			
Diopter adjustment	±5 diopter (two eyepieces)			
Max. weight of workpiece	30kg			
Power supply	110~220V, 50/60Hz			
Dimension (L×W×H)	675×645×785mm	680×645×785mm	680×645×785mm	780×750×820mm
Weight	125kg	150kg	185kg	215kg

To be continued

Continued from previous page

OBJECTIVES SPECIFICATION

Objective(flat field semi apochromatic)	5X (included)	10X (included)	20X (included)	50X (included)	100X (optional)
Illumination	coaxial vertical light, bright and dark field				
Working distance	15.0mm	8.5mm	11.9mm	8mm	3.0mm
Depth of field range	12.27 μ m	3.06 μ m	1.72 μ m	1.00 μ m	0.43 μ m
Visible range	5.3mm	2.65mm	132mm	0.53mm	0.26mm
Numerical aperture	0.15	0.3	0.4	0.55	0.8

STANDARD DELIVERY

Main unit	1 pc
Anti-dust cover	1 pc
0.63X camera adapter (adjustable focus)	1 pc
Camera (20M pixels)	1 pc

OPTIONAL ACCESSORY

Glass calibration ruler	ISM-MAS-SCALE
100X objective	ISD-TM-100X
Polarizer	ISD-TM-PO
Analyzer	ISD-TM-AN
Differential interference module (DIC)	ISD-TM-DIC
Computer	ISD-TM-COMPUTER-E

MEASURING SOFTWARE (INCLUDED)

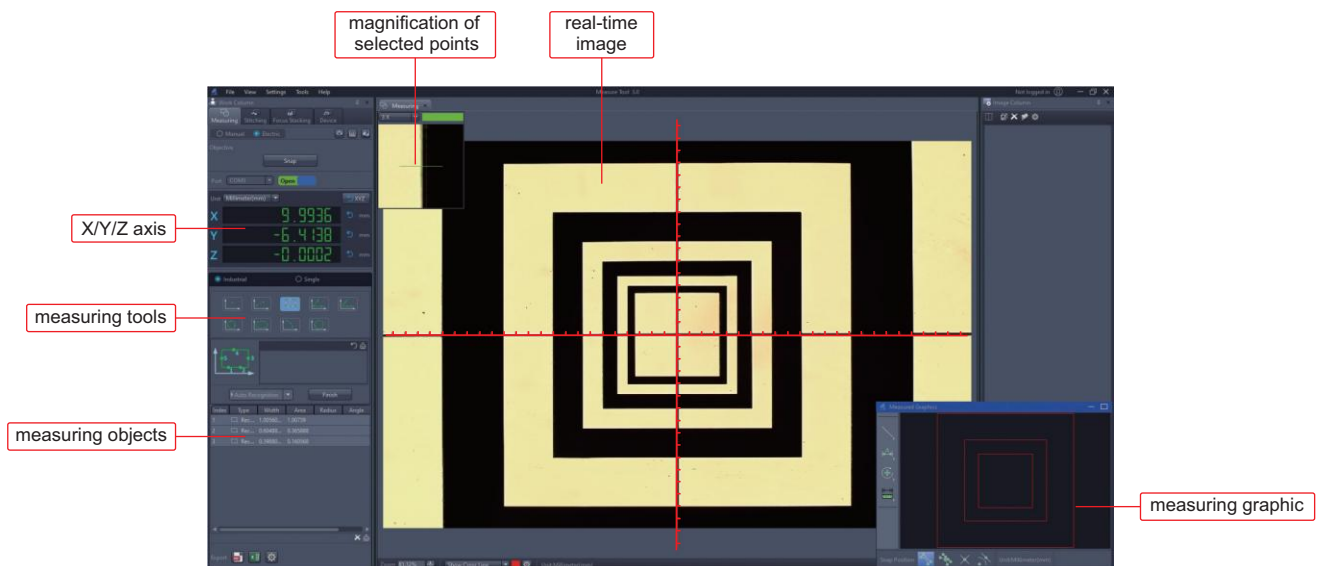

HIGH-DEFINITION AUTO FOCUS DIGITAL MICROSCOPE (LARGE VIEW FIELD) CODE 5320-AF410



AUTO FOCUS

MEASUREMENT

TAKE PICTURES
AND VIDEOS

LED INDEPENDENT
ADJUSTMENT

CAN BE CONNECTED TO PC
AND TV AT THE SAME TIME

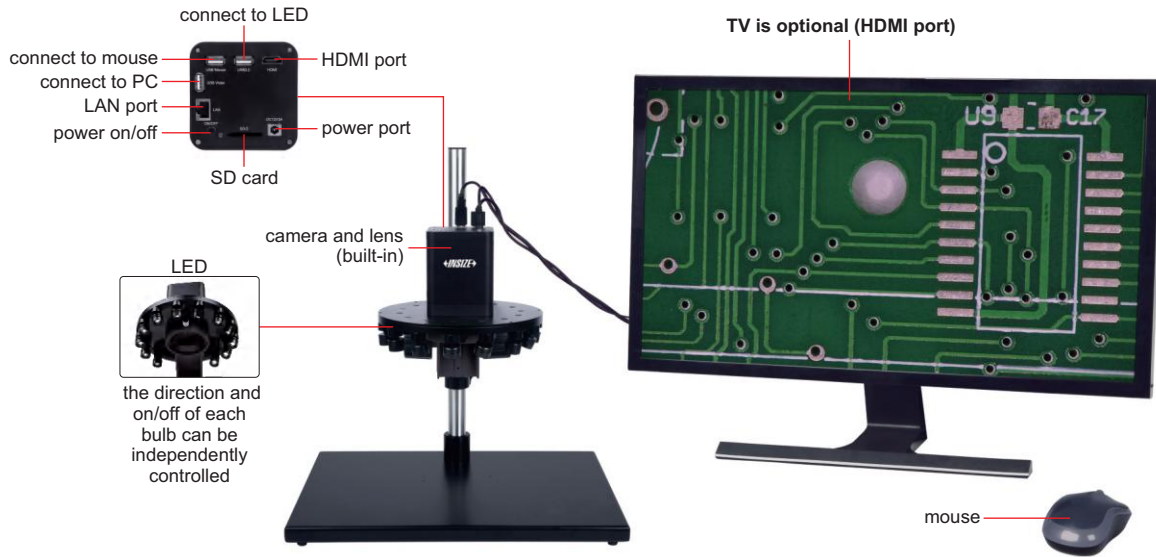

- Auto focus camera
- Take pictures and videos
- Built-in measuring software
- Automatic exposure, sharpening, denoising and white balance
- 4K/1080P automatically switched by display resolution
- Display actual magnification
- Digital magnification
- Motorized light control
- Display cross hair and gridline

computer and TV are optional



can be connected to PC and TV at the same time

SPECIFICATION

Magnification (on 28" TV)	2.4X~43.7X
View field	14.2×8~255×145mm
Auto focus distance	200~255mm
Sensor	1/2.8" CMOS
Pixel	8M
Resolution	3840×2160
Frame rate	30fps
Output	HDMI/USB/LAN
Power supply	power adapter
Dimension (L×W×H)	400×300×450mm
Weight	5.8kg

MEASURING ACCURACY (ON 28" TV)

Optical magnification	Measuring accuracy
2X	±0.1mm
4X	±0.1mm
6X	±0.04mm
10X	±0.02mm
14X	±0.02mm
18X	±0.01mm

STANDARD DELIVERY

Main unit (with stand)	1 pc
LED illumination	1 pc
32G memory card and holder	1 pc
Mouse	1 pc
HDMI cable	1 pc
USB 2.0 cable	1 pc
Power adapter	1 pc

To be continued

Continued from previous page

SOFTWARE FOR TV (INCLUDED)

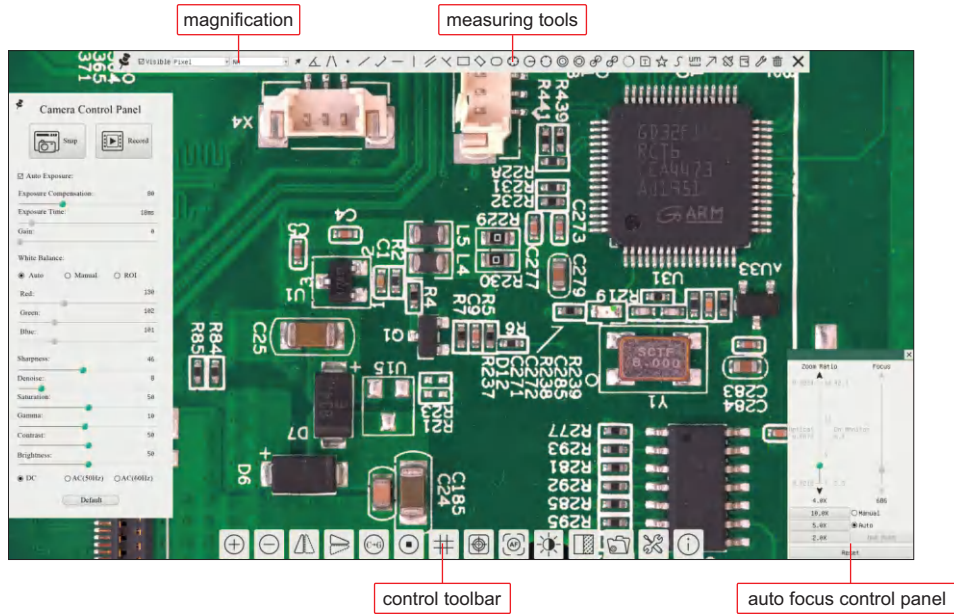

PROFESSIONAL SOFTWARE (INCLUDED, FOR COMPUTER)

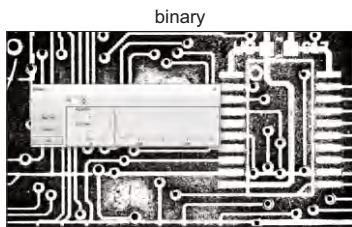

separate target and background

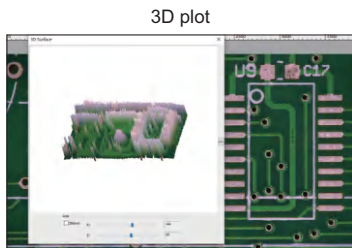

visualize the distribution of image brightness and color

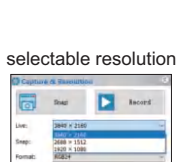
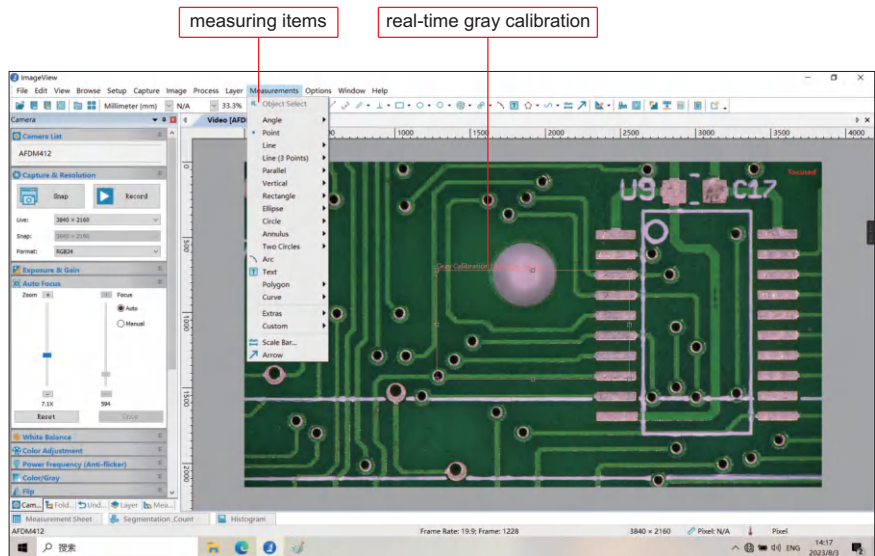

selectable resolution

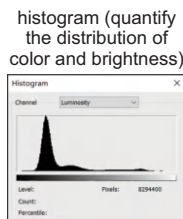

histogram (quantify the distribution of color and brightness)

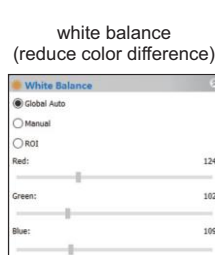

white balance (reduce color difference)

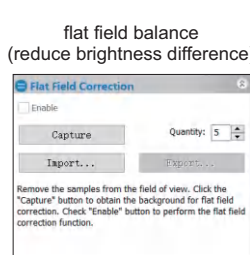

flat field balance (reduce brightness difference)

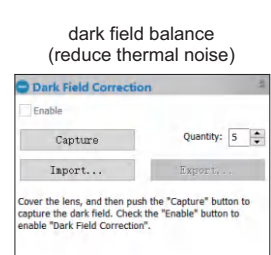

dark field balance (reduce thermal noise)

the software can control image completely, including measurement, image stitching, image gray processing, RGB histogram observation, image color sampling, 3D plot (3D representation of image intensity), image exposure, white balance, image bit depth, flat field correction and dark field correction, etc.

AUTO FOCUS DIGITAL MICROSCOPES (LARGE VIEW FIELD)

TAKE PICTURES AND VIDEOS

MEASUREMENT

CAN BE CONNECTED TO PC AND TV AT THE SAME TIME

AUTO FOCUS



connect to computer through cable to save pictures (software for computer is included)



optical zoom adjustment

controller (optional, for TV)

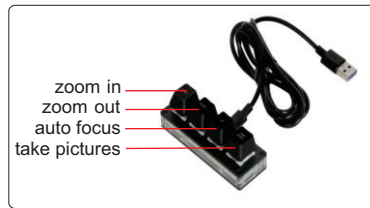

- Auto focus camera
- Take pictures and videos
- Can be connected to TV (HDMI port) and computer (RJ45 port) at the same time
- Built-in measuring software for TV
- Measuring software for computers is included
- Automatic exposure and white balance
- Brightness, contrast ratio, gain are adjustable
- Display cross hair (blue/green/red /yellow/black/brown colors)

SPECIFICATION

Code	5302-AF105 (standard type)	5302-AF108 (high-definition type)
Pixel	2M	8M
Resolution	1920×1080	3840×2160
Magnification	1.4X~25.8X (on 28" TV)	1.4X~51.6X (on 28" TV)
Sensor	1/2.8" CMOS	
Auto focus distance	100mm~∞	
Output	HDMI, RJ45	
Frame rate	HDMI: 60fps, RJ45: 50fps	
Power supply	power adapter	
Dimension (L×W×H)	500×280×410mm	
Weight	17kg	

VIEW FIELD

Focus distance	Adjustable magnification (on 28" TV)	View field
100mm	3.9~25.8X	24×14~168×91mm
150mm	2.6~20X	30×17~240×128mm
200mm	2.1~17X	37×20~315×170mm
250mm	1.7~14.7X	42×24~385×210mm
270mm	1.4~14X	43×25~415×225mm

MEASURING ACCURACY

Optical magnification (5302-AF105)	Optical magnification (5302-AF108)	Measuring accuracy
2X	2X	±0.1mm
4X	4X	±0.1mm
6X	6X	±0.04mm
8X	8X	±0.02mm
14X	14X	±0.02mm
/	28X	±0.02mm

TV SOFTWARE (INCLUDED)

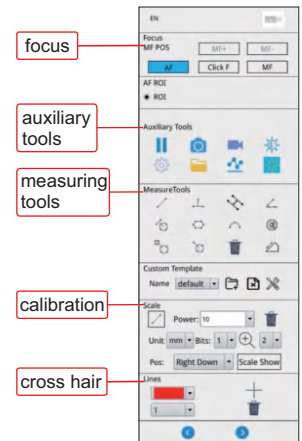

STANDARD DELIVERY

Main unit (with stand)	1 pc
LED illumination	1 pc
16G USB flash disk	1 pc
Mouse	1 pc
HDMI cable (for TV)	1 pc
Network cable (for computer)	1 pc
Switch	1 pc
Software for computer	1 pc
Power adapter	2 pcs

OPTIONAL ACCESSORY

28" 4K TV	5302-AF-TV28
32" 4K TV	5302-AF-TV32
Computer	5302-AF-COMPUTER
Controller	5302-AF-CONTROLLER

AUTO FOCUS

TAKE PICTURES AND VIDEOS

MEASUREMENT

AUTO FOCUS DIGITAL MICROSCOPE CODE 5303-AF103

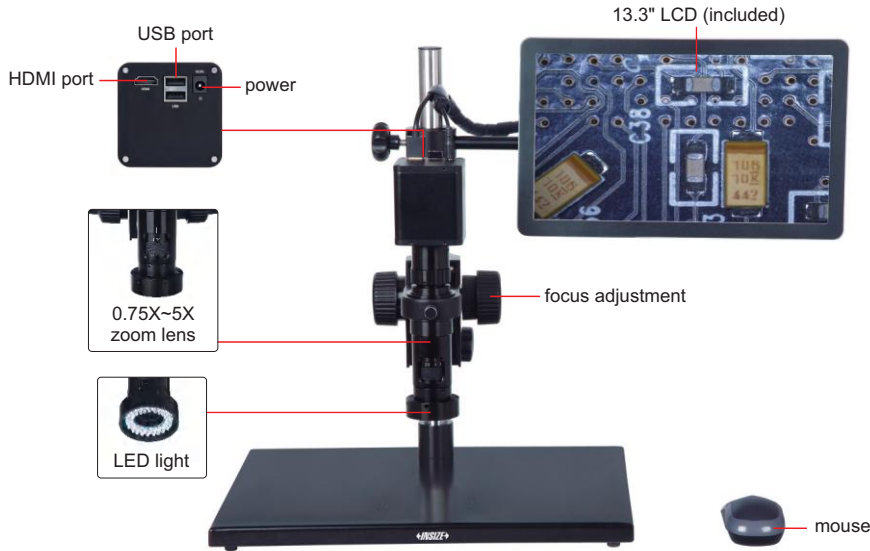

16G USB flash disk (included)



0.5X camera adapter (included)



1X auxiliary objective (included)



2X auxiliary objective (optional)



mouse

- 1080P high-definition image
- Auto focus camera
- Take pictures and videos, saved to USB flash disk
- Picture review, picture compare
- Automatic exposure and white balance
- Brightness, contrast ratio, gain are adjustable
- Display cross hair (blue/green/red/yellow/black/brown colors)
- Built-in software without computer, operation by mouse

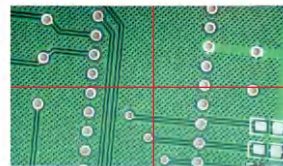

display cross hair (blue/green/red/yellow/black/brown colors)



1X camera adapter (optional)

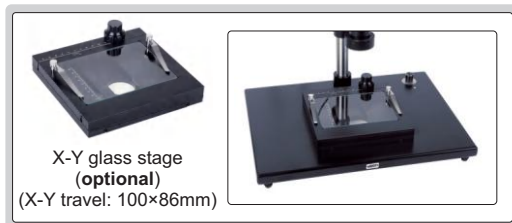

X-Y glass stage (optional)

(X-Y travel: 100×86mm)

SPECIFICATION

Magnification	20X~123X
Sensor	1/2.8" CMOS
Pixel	2M
Resolution	1920×1080
Frame rate	60fps
Output	HDMI
Power supply	power adapter
Dimension (L×W×H)	570×300×430mm
Weight	6.5kg

MAGNIFICATION, FOCUS DISTANCE AND VIEW FIELD

Auxiliary objective	Specification	Camera adapter	
		0.5X (included)	1X (optional)
1X (included)	magnification	20~123X	40~246X
	focus distance	48~84mm	48~84mm
	view field	13×7~2.2×1mm	6.3×3.5~1.1×0.5mm
2X (optional)	magnification	40~246X	80~492X
	focus distance	24~42mm	24~42mm
	view field	6.5×3.5~1.1×0.5mm	3.3×1.8~0.6×0.3mm
	measuring accuracy	±0.02mm	±0.02mm

AUTO FOCUS DISTANCE

Zoom objective scale	0.75X	1X	1.5X	2X	2.5X
Auto focus distance (mm)	48~84	50~78	55~73	62~71	65~70
Zoom objective scale	3X	3.5X	4X	4.5X	5X
Auto focus distance (mm)	66~70	67~70	68~70	68~70	68~70

STANDARD DELIVERY

Main unit	1 pc
0.5X camera adapter	1 pc
1X auxiliary objective	1 pc
Calibration plate	1 pc
16G USB flash disk	1 pc
White/black plate	1 pc
Mouse	1 pc
HDMI cable	1 pc
Power adapter	2 pcs

OPTIONAL ACCESSORY

1X camera adapter	ISM-DL-CA1X
2X auxiliary objective	ISM-DL-OB2X
X-Y glass stage (travel: 100×86mm)	ISM-DL-STAGE
X-Y metal stage	ISM-DL-STAGE1
LED light	page 728~729
Auxiliary objective	page 730

4K AUTO FOCUS MEASURING MICROSCOPE CODE 5315-S710

IMAGE
STITCHING

DUAL SCREEN
OPERATION

FOCUS
STACKING

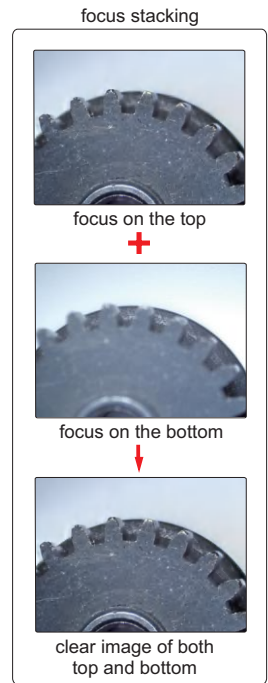
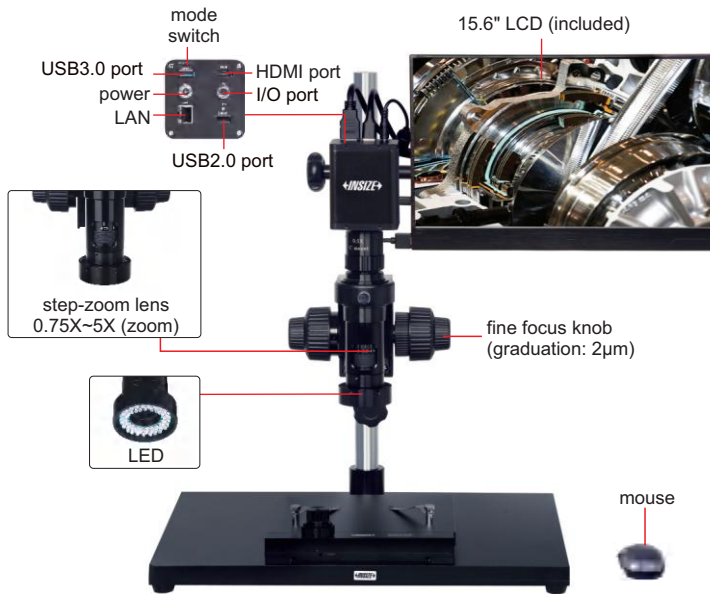

- 4K high-definition image
- Switchable LCD mode and computer mode
- Take pictures or videos, save to memory card
- Measurement results can be sent to Excel
- Auto focus
- Automatic white balance and exposure

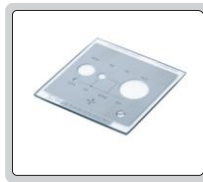

calibration plate
(included)



1X camera adapter
(optional)



2X auxiliary objective
(optional)

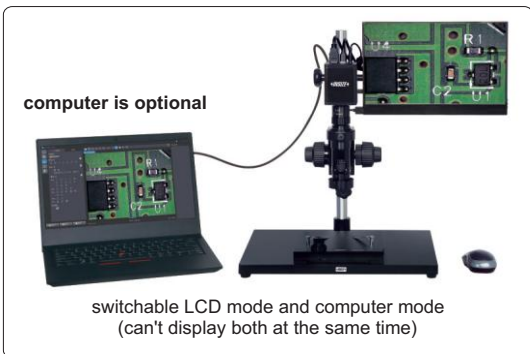
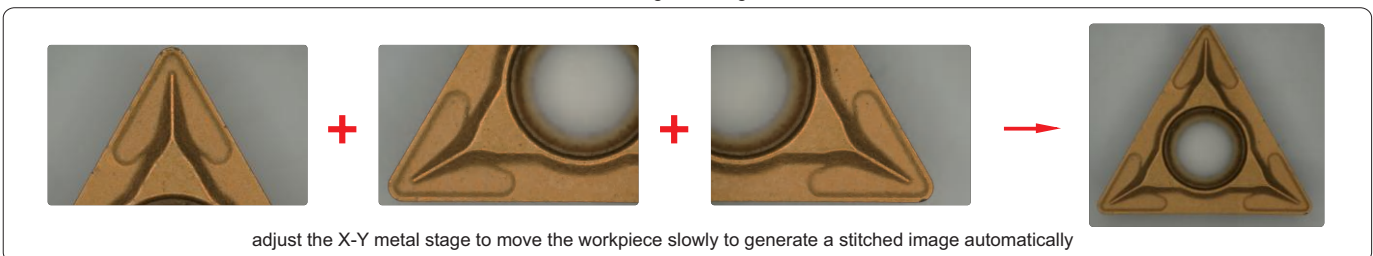

image stitching



To be continued

Continued from previous page

SPECIFICATION

Magnification	17.5X~109X (on 15.6" LCD)
Sensor	1/1.7" CMOS
Pixel	12M
Resolution	4000×3000
Frame rate	30fps
Output	HDMI/USB/LAN
Power supply	power adapter
Dimension (L×W×H)	570×300×430mm
Weight	15kg

STANDARD DELIVERY

Main unit	1 pc
0.5X camera adapter	1 pc
1X auxiliary objective	1 pc
Calibration plate	1 pc
16G USB flash drive	1 pc
Mouse	1 pc
X-Y metal stage	1 pc

MAGNIFICATION, FOCUS DISTANCE AND VIEW FIELD (on 15.6" LCD)

Specification	Camera adapter	
	0.5X (included)	1X (optional)
Magnification	17.5~109X	35~218X
Focus distance	73±2mm	73±2mm
View filed	19.2×11.0~3.2×1.9mm	9.6×5.5~1.6×0.9mm

OPTIONAL ACCESSORY

1X camera adapter	ISM-DL-CA1X
2X auxiliary objective	ISM-DL-OB2X
Computer	ISM-DL-COMPUTER
LED light	page 728~729
Auxiliary objective	page 730

MAGNIFICATION AND MEASURING ACCURACY (on 15.6" LCD)

Objective magnification	Image magnification	Measuring accuracy
0.75X	17.5X	±20µm
1X	23X	±20µm
1.5X	33X	±20µm
2X	45X	±20µm
2.5X	55X	±20µm
3X	65X	±20µm
3.5X	75X	±20µm
4X	85X	±10µm
4.5X	100X	±10µm
5X	109X	±10µm

SOFTWARE FOR LCD (INCLUDED)

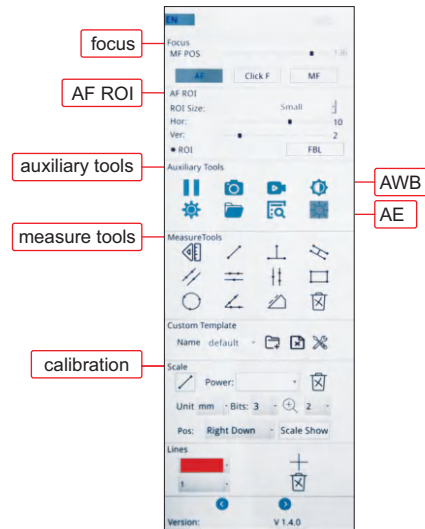

SOFTWARE FOR COMPUTER (INCLUDED)

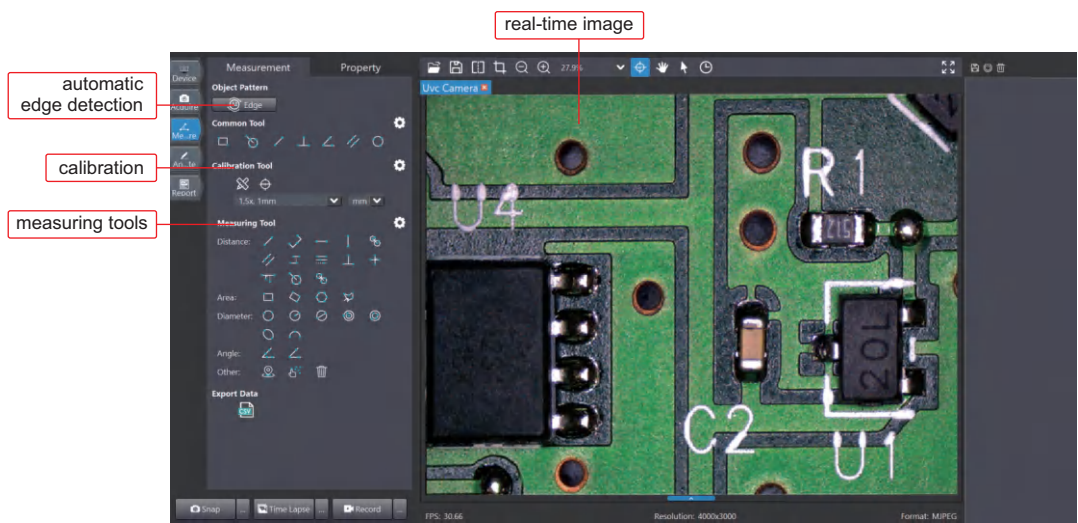

MOTORIZED 3D ROTATION MICROSCOPE CODE 5301-D400

TAKE PICTURES
AND VIDEOS

SUITABLE TO CHECK CONVEX
OBJECTS AND WALL OF HOLE

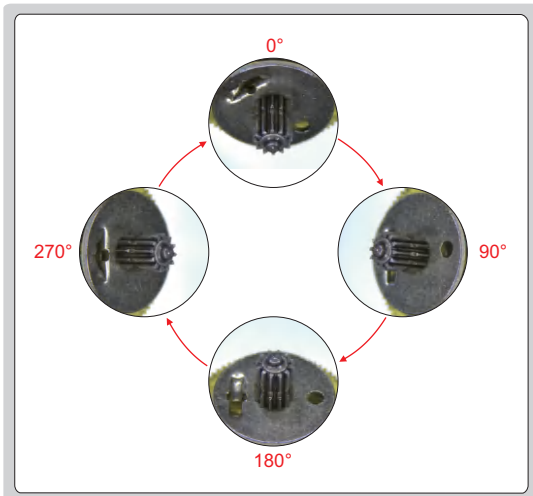
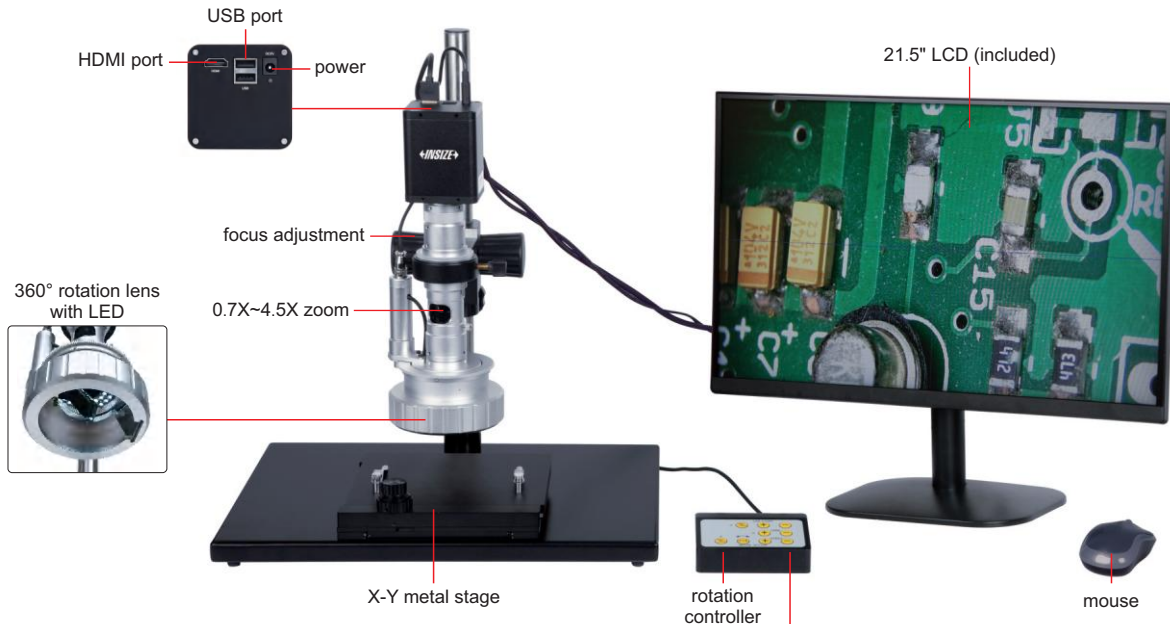

360° rotation observation

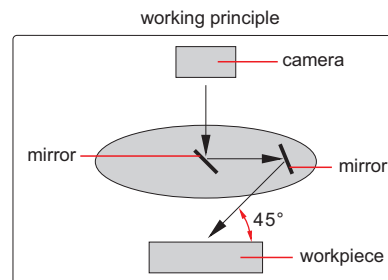
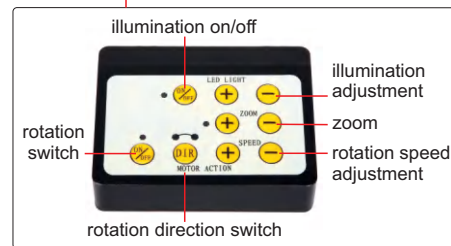

SPECIFICATION

Magnification	15X~100X
View field	4.2×2.7mm~28×18mm
Focus distance	40mm
View angle	45°
Sensor	1/2.8" CMOS
Pixel	2M
Resolution	1920×1080
Frame rate	60fps
Output	HDMI
Rotation speed	2~4RPM
Power supply	110/220V, 50/60Hz
Dimension (L×W×H)	570×300×430mm
Weight	10kg

- 1080P high-definition 3D image
- Take pictures and videos, save to USB flash disk
- Automatic white balance and exposure
- Brightness, contrast ratio and gain are adjustable

STANDARD DELIVERY

Main unit	1 pc
Rotation controller	1 pc
X-Y metal stage	1 pc
16G USB flash disk	1 pc
White/black plate	1 pc
Mouse	1 pc
Power adapter	2 pcs

TAKE PICTURES AND VIDEOS

SUITABLE TO CHECK CONVEX OBJECTS AND WALL OF HOLES

MANUAL 3D ROTATION MICROSCOPE CODE 5313-S407

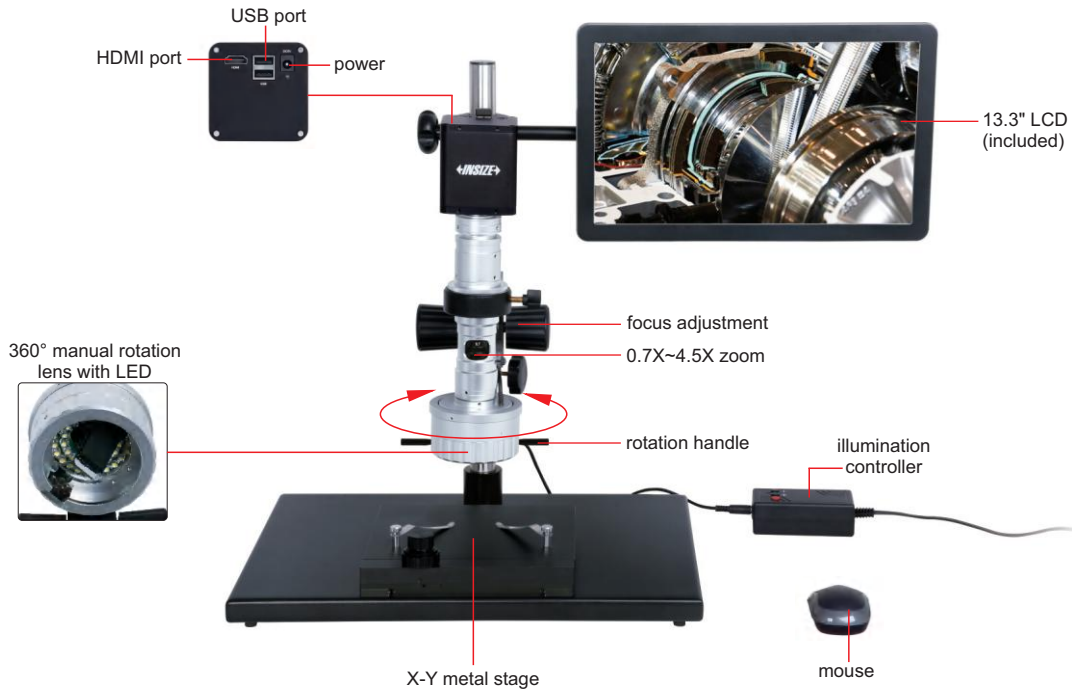

360° manual rotation lens with LED



working principle

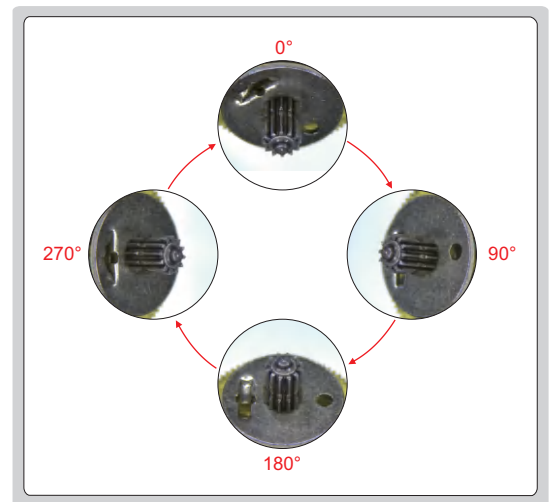
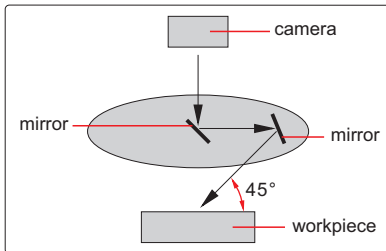

360° rotation observation

SPECIFICATION

Magnification	18X~120X
View field	2.4×1.5mm~16×9mm
Focus distance	20mm
View angle	45°
Sensor	1/2.8" CMOS
Pixel	2M
Resolution	1920×1080
Frame rate	60fps
Output	HDMI
Power supply	220V, 50/60Hz
Dimension (L×W×H)	570×300×430mm
Weight	10kg

STANDARD DELIVERY

Main unit	1 pc
X-Y metal stage	1 pc
16G USB flash disk	1 pc
White/black plate	1 pc
Mouse	1 pc
Power adapter	2 pcs

DIGITAL MEASURING MICROSCOPES

BUILT-IN SOFTWARE
WITHOUT COMPUTER

MEASUREMENT

TAKE
PICTURES



0.5X camera adapter
(included)



1X auxiliary objective
(included)

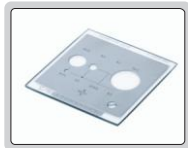

calibration plate
(included)



16G USB flash disk
(included)



1X camera adapter
(optional)



2X auxiliary objective
(optional)

- 1080P high-definition image
- Built-in software without computer, operated by mouse
- Take pictures, save to USB flash disk
- Measurement results can be sent to Excel
- Automatic white balance and exposure
- Brightness, contrast ratio, gain are adjustable

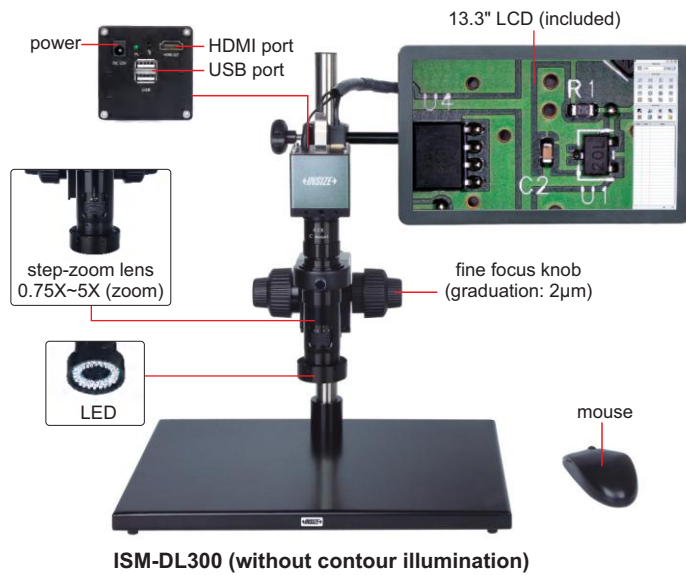

ISM-DL300 (without contour illumination)

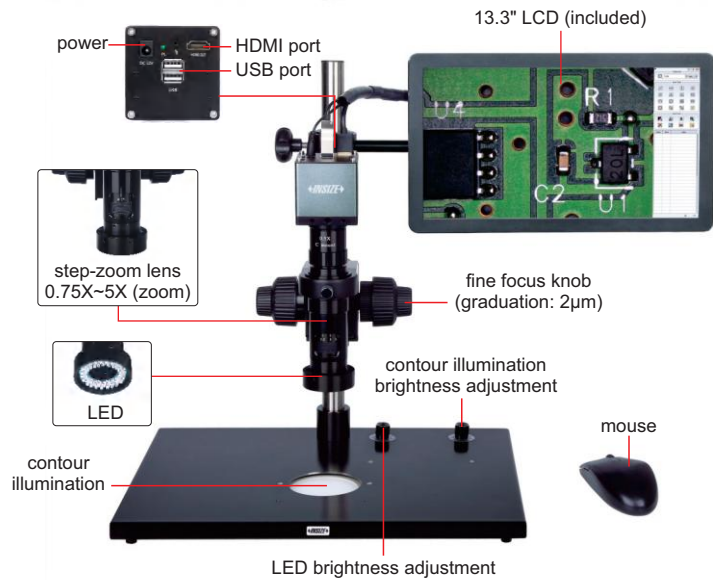

ISM-DL301 (with contour illumination)

SPECIFICATION

Code	ISM-DL300 (without contour illumination)	ISM-DL301 (with contour illumination)
Magnification	15X-100X	
Sensor	1/2" CMOS	
Pixel	2M	
Resolution	1920×1080	
Frame rate	60fps	
Output	HDMI	
Power supply	power adapter	
Dimension (L×W×H)	570×300×430mm	
Weight	6.5kg	

To be continued

Continued from previous page

STANDARD DELIVERY

Main unit	1 pc
0.5X camera adapter	1 pc
1X auxiliary objective	1 pc
Calibration plate	1 pc
16G USB flash disk	1 pc
White/black plate	1 pc
Mouse	1 pc
HDMI cable	1 pc
Power adapter	2 pcs

OPTIONAL ACCESSORY

1X camera adapter	ISM-DL-CA1X
2X auxiliary objective	ISM-DL-OB2X
X-Y glass stage (travel: 100×86mm)	ISM-DL-STAGE
X-Y metal stage	ISM-DL-STAGE1
LED light	page 728~729
Auxiliary objective	page 730

MAGNIFICATION AND MEASURING ACCURACY

Objective magnification	Image magnification	Measuring accuracy *
0.75X	15X	±8μm
1X	20X	±7μm
1.5X	30X	±6μm
2X	40X	±6μm
2.5X	50X	±6μm
3X	60X	±5μm
3.5X	70X	±5μm
4X	80X	±4μm
4.5X	90X	±4μm
5X	100X	±4μm

* When measuring the contour of workpieces, please use ISM-DL301 to ensure accuracy.



MAGNIFICATION, FOCUS DISTANCE AND VIEW FIELD

Auxiliary objective	Specification	Camera adapter	
		0.5X (included)	1X (optional)
1X (included)	magnification	15~100X	30~200X
	focus distance	70±2mm	70±2mm
	view filed	16×11~2.5×1.6mm	7.8×5.3~1.2×0.8mm
2X (optional)	magnification	30~200X	60~400X
	focus distance	29±2mm	29±2mm
	view filed	7.8×5.3~1.2×0.8mm	3.8×2.7~0.6×0.4mm

SOFTWARE (INCLUDED)

- Refer to page 727 for details

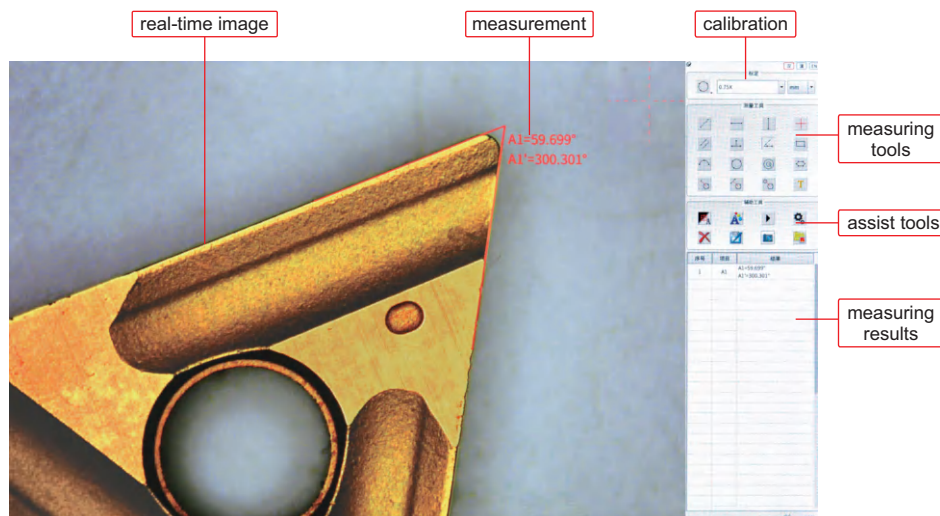

DIGITAL MEASURING MICROSCOPE (BASIC TYPE)



MEASUREMENT

TAKE PICTURES

BUILT-IN SOFTWARE WITHOUT COMPUTER

POPULAR MODEL



16G USB flash disk (included)



white/black plate (included)

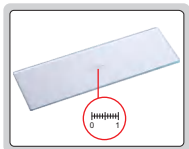

glass calibration ruler (graduation 0.1mm, included)

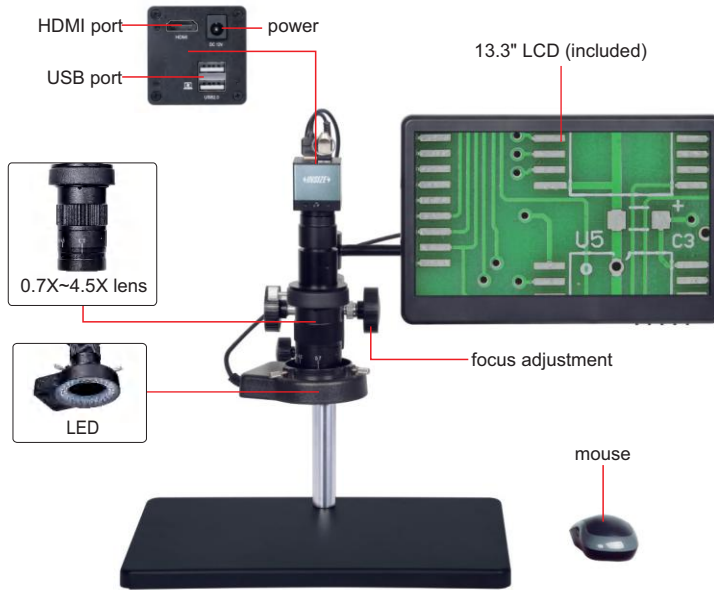

5318-MD60 (without stage)

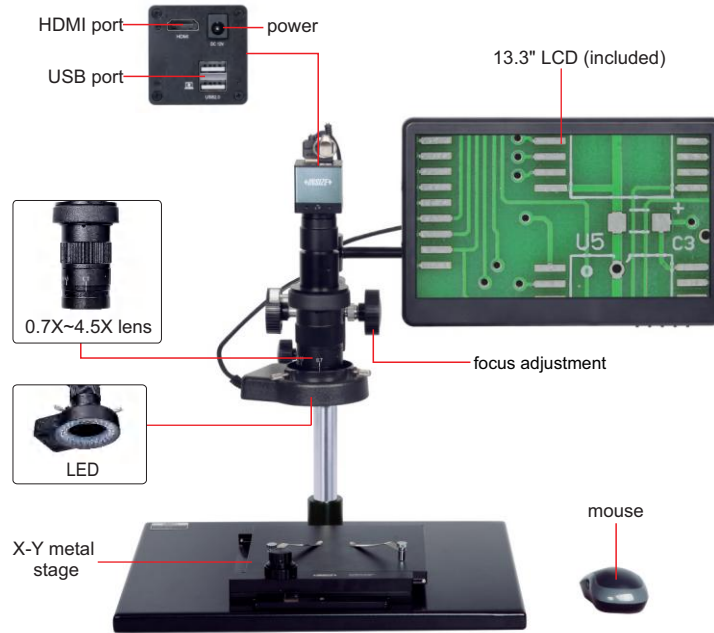

5318-MD60-XY (with stage)

- 1080P high-definition image
- Built-in software without computer, operated by mouse
- Take pictures, save to USB flash disk
- Measurement results can be sent to Excel
- Brightness, contrast ratio, gain are adjustable

To be continued

Continued from previous page

SPECIFICATION

Code	5318-MD60 (without stage)	5318-MD60-XY (with stage)
Magnification	12.5X~80X	12.5X~80X
Sensor	1/2.8" CMOS	1/2.8" CMOS
Pixel	2M	2M
Resolution	1920×1080	1920×1080
Frame rate	60fps	60fps
Measuring accuracy	±0.02mm	±0.02mm
Lines	cross lines, scale lines (number, color and position of lines are adjustable)	cross lines, scale lines (number, color and position of lines are adjustable)
Output	HDMI	HDMI
Power supply	power adapter	power adapter
Dimension (L×W×H)	380×260×350mm	570×300×430mm
Weight	4.5kg	10kg

STANDARD DELIVERY

Code	5318-MD60 (without stage)	5318-MD60-XY (with stage)
Main unit	1 pc	1 pc
0.5X camera adapter	1 pc	1 pc
1X auxiliary objective	1 pc	1 pc
White/black plate	1 pc	1 pc
Glass calibration ruler	1 pc	1 pc
16G USB flash disk	1 pc	1 pc
Mouse	1 pc	1 pc
HDMI cable	1 pc	1 pc
Power adapter	3 pcs	3 pcs
X-Y metal stage	/	1 pc

MAGNIFICATION AND VIEW FIELD

Auxiliary objective	Specification	Camera adapter
		0.5X (included)
0.5X (optional)	magnification	6.2~40X
	view field	47×26~7.4×4mm
1X (included)	magnification	12.5~80X
	view field	23.5×13~3.7×2mm
2X (optional)	magnification	25~160X
	view field	11.8×6.5~1.8×1mm

OPTIONAL ACCESSORY

0.5X auxiliary objective	5318-OB05X
2X auxiliary objective	5318-OB2X

MEASURING SOFTWARE (INCLUDED)

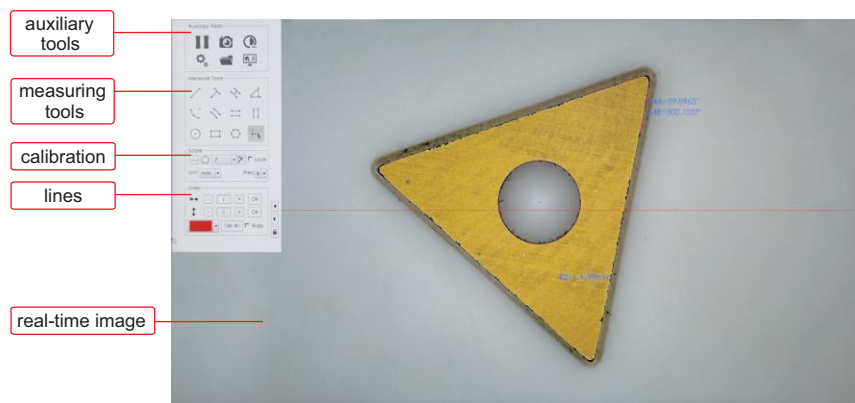

4K DIGITAL MEASURING MICROSCOPE CODE 5310-DL401

BUILT-IN SOFTWARE
WITHOUT COMPUTER

TAKE
PICTURES

MEASUREMENT

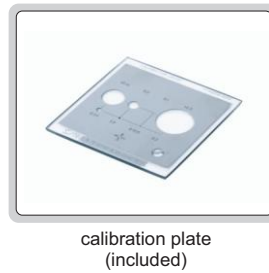
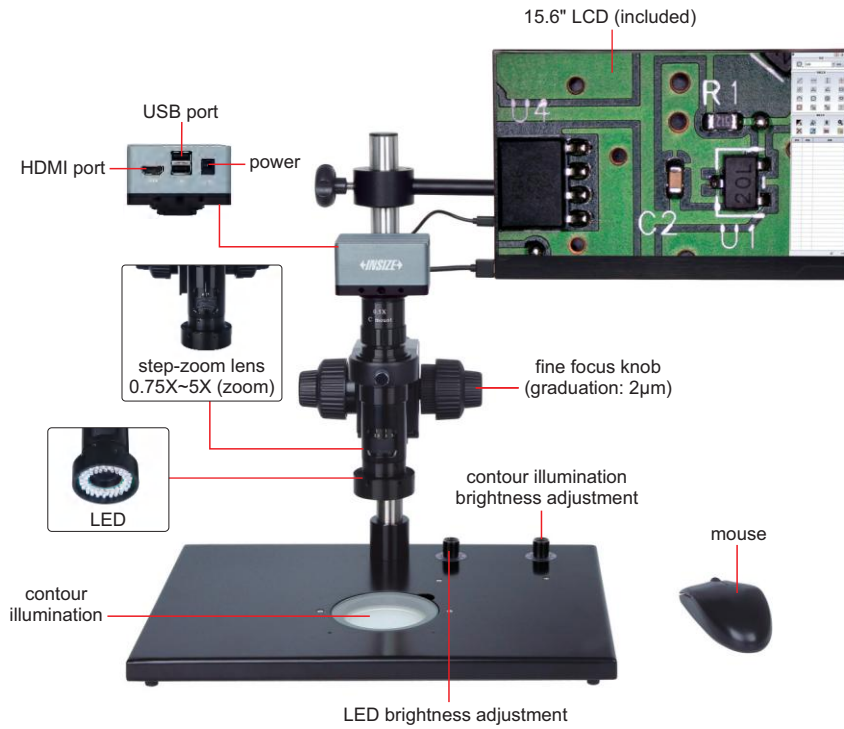

- 4K high-definition image
- Built-in software without computer, operated by mouse
- Take pictures, save to USB flash disk
- Measurement results can be sent to Excel
- Automatic white balance and exposure
- Brightness, contrast ratio, gain are adjustable

24

SPECIFICATION

Magnification	17.6X~120X
Sensor	1/2.3" CMOS
Pixel	8M
Resolution	3840×2160
Frame rate	4K: 30fps, 1080P: 60fps
Output	HDMI
Power supply	power adapter
Dimension (L×W×H)	570×300×430mm
Weight	6.5kg



To be continued

Continued from previous page

MAGNIFICATION, VIEW FIELD AND MEASURING ACCURACY

Objective magnification	Image magnification	View field	Measuring accuracy
0.75X	17.6X	19.5×11.5mm	±5μm
1X	23.7X	14.0×8.0mm	±5μm
1.5X	36.6X	9.0×5.0mm	±5μm
2X	49X	7.0×4.0mm	±5μm
2.5X	62X	5.5×3.0mm	±4μm
3X	73X	4.5×2.5mm	±4μm
3.5X	85X	4.0×2.2mm	±4μm
4X	97X	3.5×2.0mm	±3μm
4.5X	109X	3.0×1.8mm	±3μm
5X	120X	2.7×1.5mm	±3μm

STANDARD DELIVERY

Main unit	1 pc
0.5X camera adapter	1 pc
1X auxiliary objective	1 pc
Calibration plate	1 pc
16G USB flash disk	1 pc
White/black plate	1 pc
Mouse	1 pc
HDMI cable	1 pc
Power adapter	3 pcs

OPTIONAL ACCESSORY

1X camera adapter	ISM-DL-CA1X
2X auxiliary objective	ISM-DL-OB2X
X-Y glass stage (travel: 100×86mm)	ISM-DL-STAGE
X-Y metal stage (travel: 100×86mm)	ISM-DL-STAGE1
LED light	page 728~729
Auxiliary objective	page 730

SOFTWARE (INCLUDED)

- Refer to page 727 for details

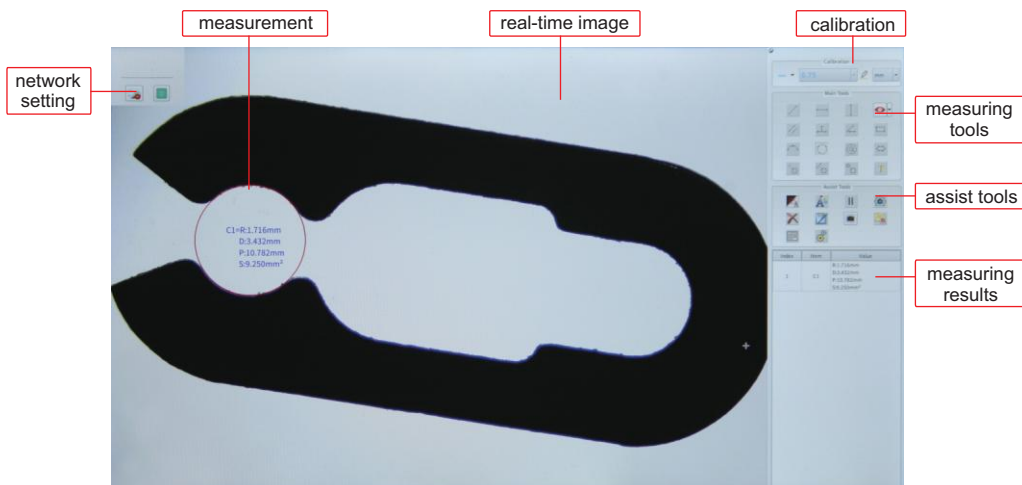

HIGH MAGNIFICATION MEASURING MICROSCOPE CODE ISM-DL302



SOFTWARE IS INCLUDED,
REFER TO PAGE 727 FOR DETAILS

OBSERVATION AND MEASUREMENT
AT HIGH MAGNIFICATION

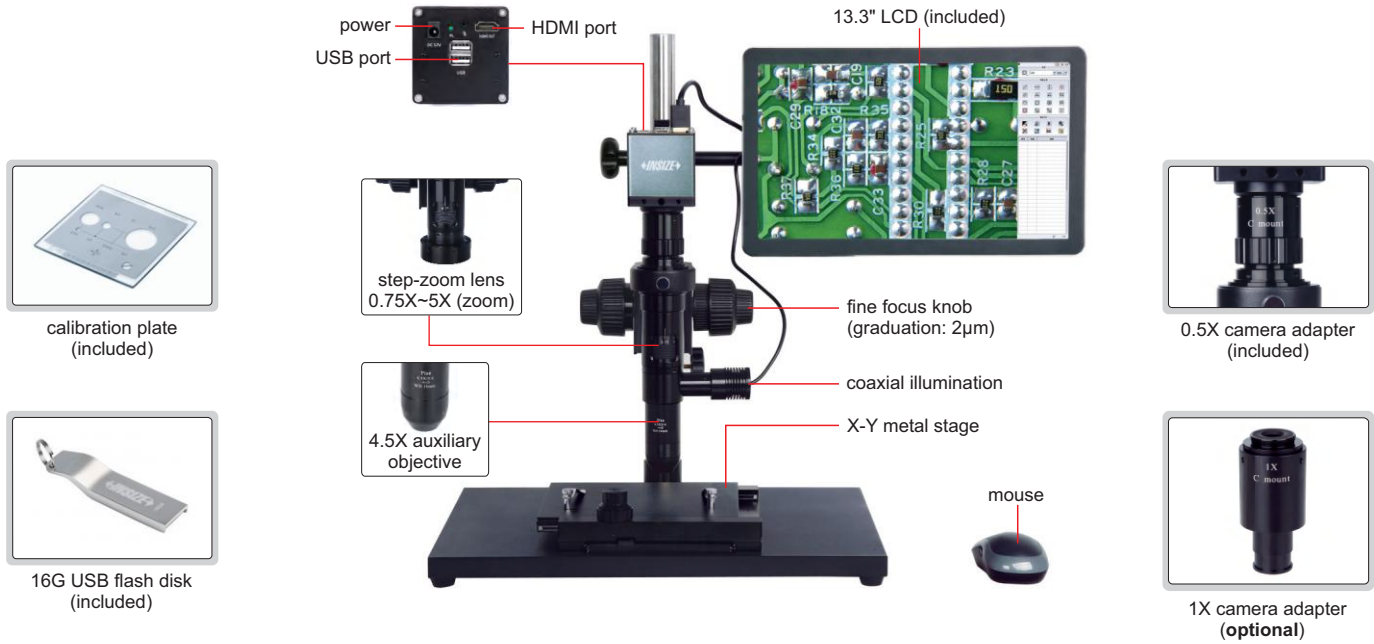

- 1080P high-definition image
- Maximum 1000X optical magnification (using camera adapter 1X, optional)
- Built-in software without computer, operated by mouse
- Solid base and column to avoid lens shaking during focusing
- Software is included, refer to page 727 for details

SPECIFICATION

Magnification	78X~504X
Sensor	1/2" CMOS
Pixel	2M
Resolution	1920×1080
Frame rate	60fps
Output	HDMI
Power supply	power adapter
Dimension (L×W×H)	570×300×430mm
Weight	15kg

MAGNIFICATION AND MEASURING ACCURACY

Objective magnification	Image magnification	Measuring accuracy
0.75X	78X	±5μm
1X	102X	±4μm
1.5X	153X	±4μm
2X	204X	±4μm
2.5X	255X	±4μm
3X	305X	±4μm
3.5X	356X	±4μm
4X	408X	±4μm
4.5X	458X	±4μm
5X	504X	±4μm

SATNDARD DELIVERY

Main unit	1 pc
0.5X camera adapter	1 pc
4.5X auxiliary objective	1 pc
Calibration plate	1 pc
16G USB flash disk	1 pc
Mouse	1 pc
HDMI cable	1 pc
X-Y metal stage	1 pc

MAGNIFICATION, FOCUS DISTANCE AND VIEW FIELD

Camera adapter	0.5X (included)	1X (optional)
Magnification	78~504X	156~1008X
Focus distance	14±2mm	14±2mm
View field	2.8×1.7~0.5×0.3mm	1.4×0.9~0.3×0.2mm

OPTIONAL ACCESSORY

1X camera adapter	ISM-DL-CA1X
LED light	page 728~729

MOTORIZED FOCUS STACKING

BUILT-IN SOFTWARE WITHOUT COMPUTER

MOTORIZED FOCUS STACKING MICROSCOPE (LARGE DEPTH OF VIEW) CODE ISM-DL520

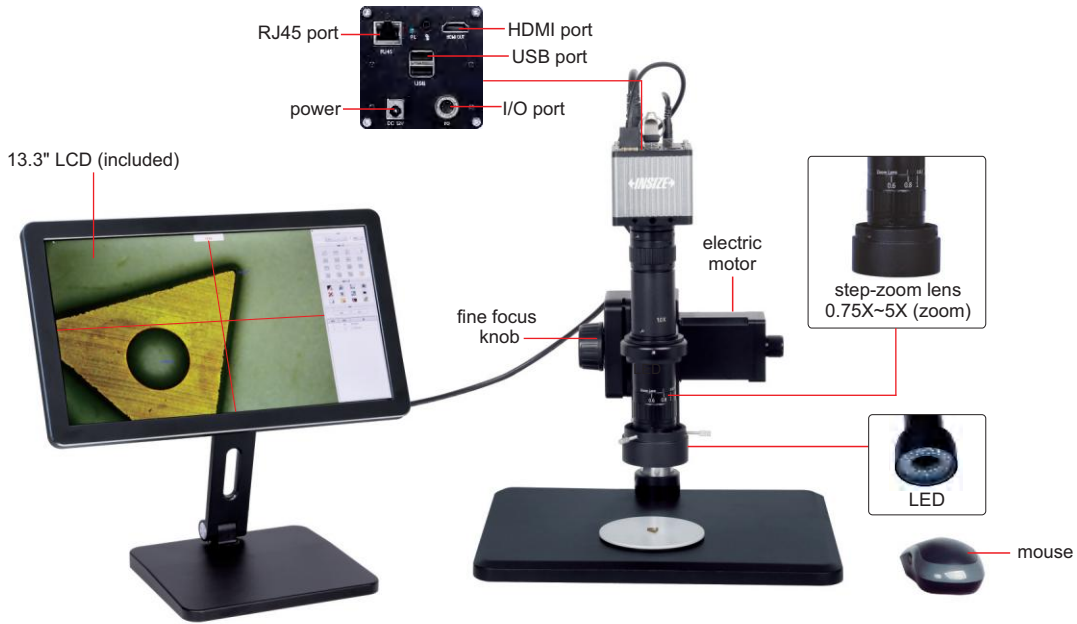

- 1080P high-definition image
- Built-in software without computer, operated by mouse
- Take pictures, save to USB flash disk
- Measurement results can be sent to Excel
- Automatic white balance and exposure
- Motorized focus stacking
- Send photos and measurement data via ethernet (TCP/IP)
- Name photos and measurement data files with serial number of workpieces read by scanner

SPECIFICATION

Magnification	24.5X~204.5X
View field	2.8×1.6~18×10mm
Focus distance	65mm
Sensor	1/1.2" CMOS
Pixel	2M
Resolution	1920×1080
Frame rate	30fps
Output	RJ45
Power supply	power adapter
Dimension (L×W×H)	320×260×500mm
Weight	7kg

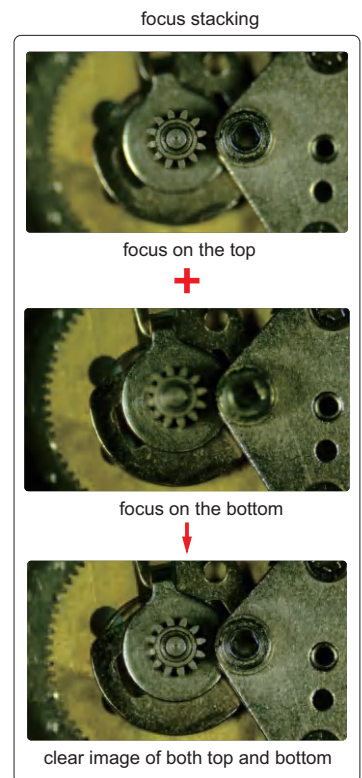

To be continued

Continued from previous page

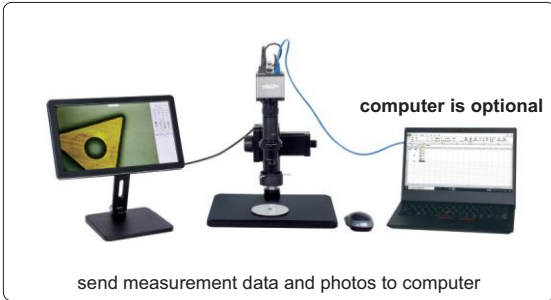

MAGNIFICATION AND MEASURING ACCURACY

Objective magnification	Image magnification	Measuring accuracy
0.6X	24.5X	±8μm
0.8X	32.7X	±7μm
1X	40.9X	±6μm
1.5X	61.3X	±6μm
2X	81.8X	±6μm
2.5X	102.2X	±5μm
3X	122.7X	±5μm
3.5X	143.1X	±4μm
4X	163.6X	±4μm
4.5X	184.0X	±4μm
5X	204.5X	±4μm



calibration plate (included)



16G USB flash disk (included)

STANDARD DELIVERY

Main unit	1 pc
1X camera adapter	1 pc
1X auxiliary objective	1 pc
Calibration plate	1 pc
16G USB flash disk	1 pc
Mouse	1 pc
LED ring light	1 pc
White/black plate	1 pc
Power adapter	3 pcs



OPTIONAL ACCESSORY

X-Y metal stage (travel: 100×86mm)	ISM-DL-STAGE1
------------------------------------	---------------

SOFTWARE (INCLUDED)

- Refer to page 727 for details

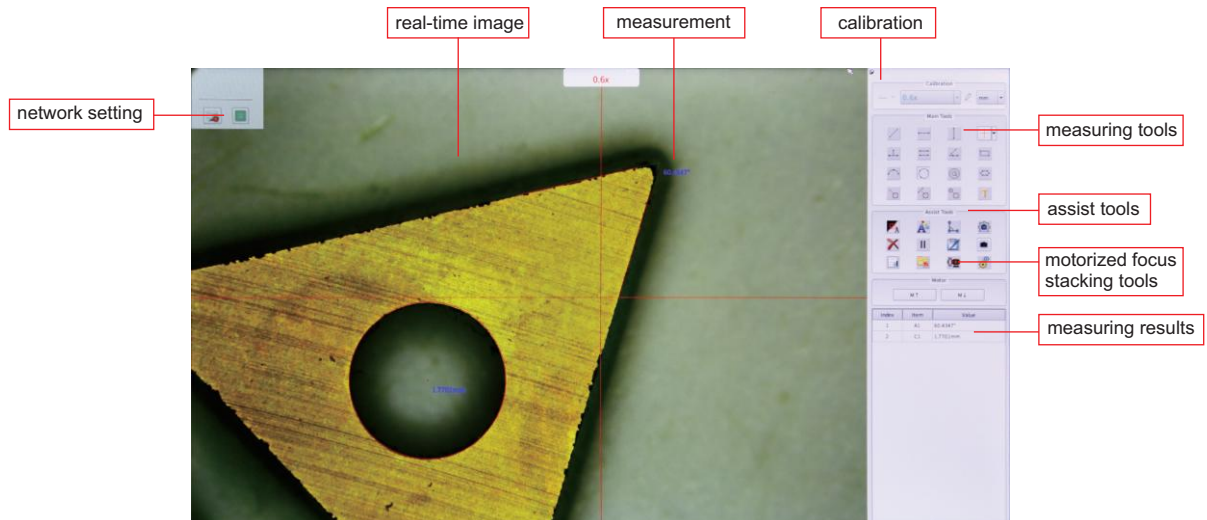

BUILT-IN SOFTWARE
WITHOUT COMPUTER

MANUAL FOCUS STACKING MICROSCOPE (LARGE DEPTH OF VIEW) CODE ISM-DL510

FOCUS
STACKING

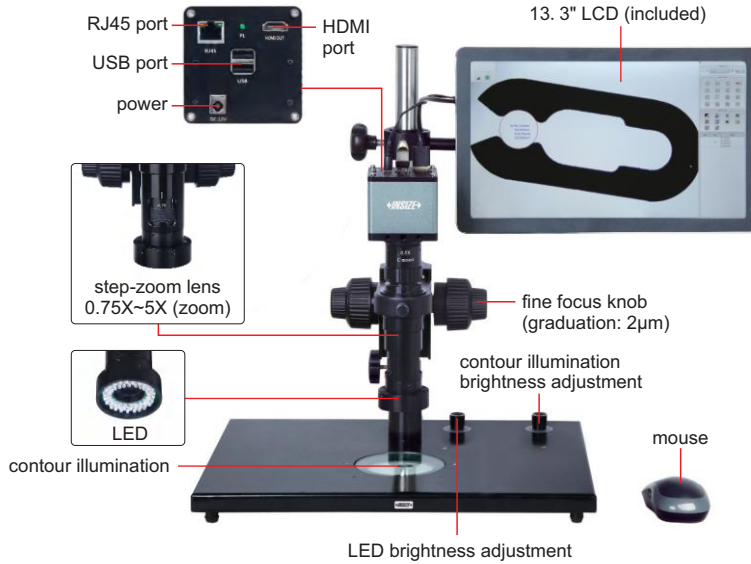

- 1080P high-definition image
- Built-in software without computer, operated by mouse
- Take pictures, save to USB flash disk
- Measurement results can be sent to Excel
- Automatic white balance and exposure
- Focus stacking
- Send photos and measurement data via ethernet (TCP/IP)
- Name photos and measurement data files with serial number of workpieces read by scanner

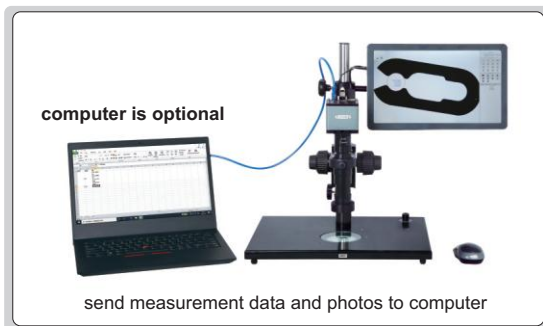
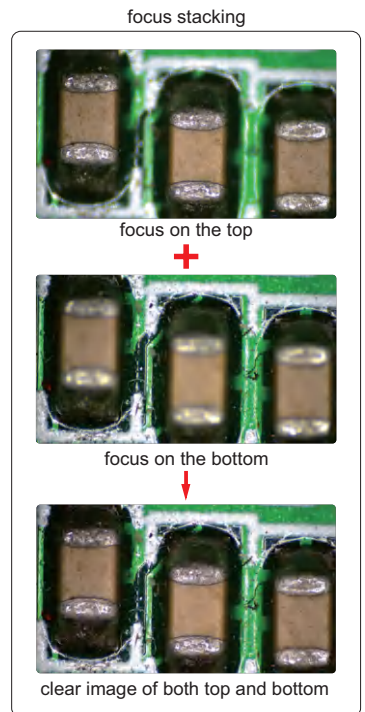

SPECIFICATION

Magnification	15X~100X
Sensor	1/2" CMOS
Pixel	2M
Resolution	1920×1080
Frame rate	60fps
Output	HDMI
Power supply	power adapter
Dimension (L×W×H)	570×300×430mm
Weight	6.5kg

To be continued

Continued from previous page

STANDARD DELIVERY

Main unit	1 pc
0.5X camera adapter	1 pc
1X auxiliary objective	1 pc
Calibration plate	1 pc
16G USB flash disk	1 pc
White/black plate	1 pc
Mouse	1 pc
Power adapter	3 pcs

OPTIONAL ACCESSORY

1X camera adapter	ISM-DL-CA1X
2X auxiliary objective	ISM-DL-OB2X
X-Y glass stage (travel: 100×86mm)	ISM-DL-STAGE
Scanner and hub	7328-SCAN
LED light	page 728~729
Auxiliary objective	page 730

MAGNIFICATION AND MEASURING ACCURACY

Objective magnification	Image magnification	Measuring accuracy
0.75X	15X	±8μm
1X	20X	±7μm
1.5X	30X	±6μm
2X	40X	±6μm
2.5X	50X	±6μm
3X	60X	±5μm
3.5X	70X	±5μm
4X	80X	±4μm
4.5X	90X	±4μm
5X	100X	±4μm



MAGNIFICATION, FOCUS DISTANCE AND VIEW FIELD

Auxiliary objective	Specification	Camera adapter	
		0.5X (included)	1X (optional)
1X (included)	magnification	15~100X	30~200X
	focus distance	70±2mm	70±2mm
	view filed	16×11~2.5×1.6mm	7.8×5.3~1.2×0.8mm
2X (optional)	magnification	30~200X	60~400X
	focus distance	29±2mm	29±2mm
	view filed	7.8×5.3~1.2×0.8mm	3.8×2.7~0.6×0.4mm

SOFTWARE (INCLUDED)

■ Refer to page 727 for details

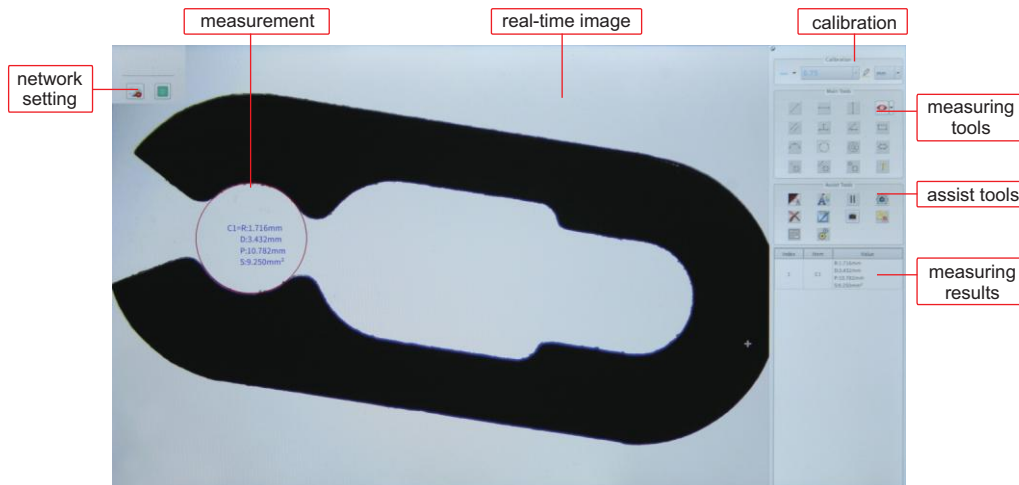



BUILT-IN SOFTWARE
WITHOUT COMPUTER

TAKE
PICTURES

HORIZONTAL MICROSCOPE CODE 5316-HM810

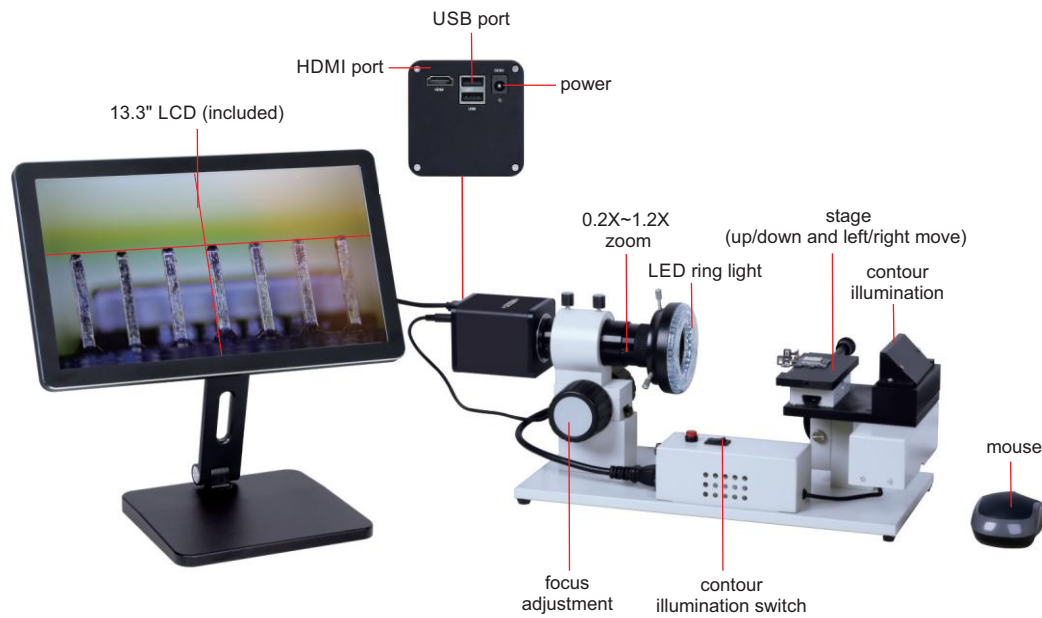

- 1080P high-definition image
- Built-in software without computer, operated by mouse
- Take pictures, save to USB flash disk
- Automatic white balance and exposure
- Brightness, contrast ratio, gain are adjustable
- Display cross hair (blue/green/red/yellow/black/brown colors)



plastic calibration ruler
(included, graduation 1mm)



16G USB flash disk
(included)

SPECIFICATION

Magnification	10.5X~62.5X
View field	4.5×2.5~28×12.3mm
Focus distance	115mm
Measuring accuracy	±0.02mm
Sensor	1/2.8" CMOS
Pixel	2M
Resolution	1920×1080
Frame rate	1080P: 60fps/50fps
Output	HDMI
Power supply	110/220V, 50/60Hz
Dimension (L×W×H)	500×200×200mm
Weight	7kg

STANDARD DELIVERY

Main unit	1 pc
1X camera adapter	1 pc
1X auxiliary adapter	1 pc
Plastic calibration ruler	1 pc
16G USB flash disk	1 pc
Mouse	1 pc
LED ring light	1 pc

SOFTWARE (INCLUDED)

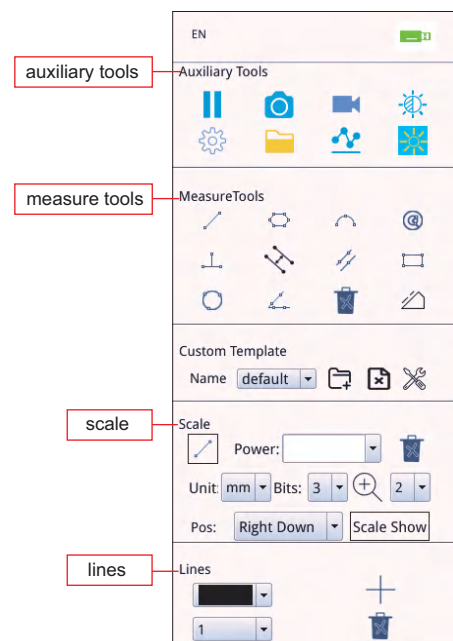

FLEXIBLE ARM AUTO FOCUS DIGITAL MICROSCOPES

AUTO FOCUS

TAKE PICTURES AND VIDEOS

MEASUREMENT

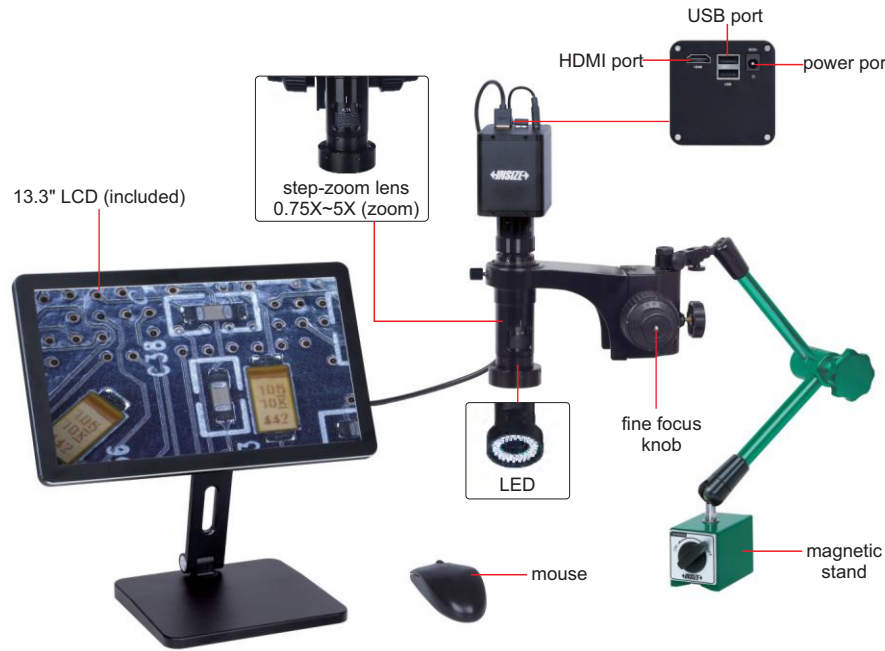

5317-AF109



5317-AF110

- 1080P high-definition image
- Auto focus camera
- Take pictures and videos, saved to USB flash disk
- Picture review, picture compare
- Automatic exposure and white balance
- Brightness, contrast ratio, gain are adjustable
- Display cross hair (blue/green/red/yellow/black/brown colors)
- Built-in software without computer, operation by mouse
- Flexible arm

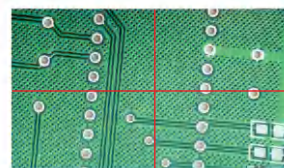

display cross hair (blue/green/red/yellow/black/brown colors)

To be continued

Continued from previous page

SPECIFICATION

Code	5317-AF109 (with magnetic stand)	5317-AF110 (with desktop clamp)
Magnification	20X~123X	
Sensor	1/2.8" CMOS	
Pixel	2M	
Resolution	1920×1080	
Frame rate	60fps	
Power supply	power adapter	
Dimension (height)	480mm	600mm
Weight	5.6kg	8.5kg



calibration plate
(included)



16G USB flash disk
(included)



0.5X camera adapter
(included)



1X auxiliary objective
(included)

MAGNIFICATION, FOCUS DISTANCE AND VIEW FIELD

Auxiliary objective	Specification	Camera adapter	
		0.5X (included)	1X (optional)
1X (included)	magnification	20~123X	40~246X
	focus distance	48~84mm	48~84mm
	view field	13×7~2.2×1mm	6.3×3.5~1.1×0.5mm
	measuring accuracy	±0.02mm	±0.02mm
2X (optional)	magnification	40~246X	80~492X
	focus distance	24~42mm	24~42mm
	view field	6.5×3.5~1.1×0.5mm	3.3×1.8~0.6×0.3mm
	measuring accuracy	±0.02mm	±0.02mm

STANDARD DELIVERY

Main unit	1 pc
0.5X camera adapter	1 pc
1X auxiliary objective	1 pc
Calibration plate	1 pc
16G USB flash disk	1 pc
White/black plate	1 pc
Mouse	1 pc
HDMI cable	1 pc
Power adapter	2 pcs

AUTO FOCUS DISTANCE

Zoom objective scale	0.75X	1X	1.5X	2X	2.5X
Auto focus distance	48~84mm	50~78mm	55~73mm	62~71mm	65~70mm
Zoom objective scale	3X	3.5X	4X	4.5X	5X
Auto focus distance	66~70mm	67~70mm	68~70mm	68~70mm	68~70mm

OPTIONAL ACCESSORY

1X camera adapter	ISM-DL-CA1X
2X auxiliary objective	ISM-DL-OB2X
Auxiliary objective	page 730

MEASURING SOFTWARE (INCLUDED)

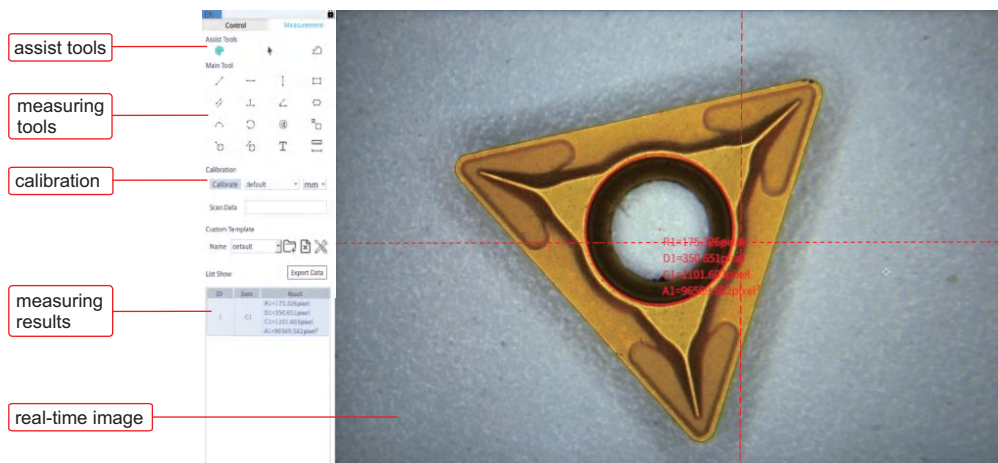

MOTORIZED ZOOM MICROSCOPE (BASIC TYPE) CODE 5325-VM100

PROGRAMMABLE SEGMENTED
RING LIGHT

DISPLAY ACTUAL
MAGNIFICATION

POPULAR
MODEL



- Built-in software without computer
- Can be connected to display and computer at the same time
- Motorized zoom objective
- Display actual magnification
- Programmable segmented ring light
- Take pictures and videos



SPECIFICATION

Sensor	1/2" CMOS
Pixel	2M
Resolution	1920×1080
Magnification	10~68.5X
Measuring accuracy	±0.02mm
Max. workpiece height	135mm
Frame rate	60fps
Output	USB/LAN/HDMI
Power supply	power adapter
Dimension (L×W×H)	261×320×480mm
Weight	5.1kg

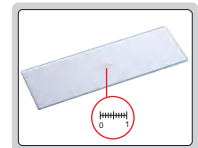

glass calibration ruler
(graduation 0.1mm,
included)

MAGNIFICATION, FOCUS DISTANCE AND VIEW FIELD (on 11.6" LCD)

Specification	Objective	
	0.5X (optional)	1X (included)
Magnification	5~34.2X	10~68.5X
Focus distance	180mm	87mm
View filed	7.4×4.2~53×31.2mm	3.7×2.1~26.5×15.6mm



white/black plate
(included)

24

STANDARD DELIVERY

Main unit	1 pc
Glass calibration ruler	1 pc
Power adapter	1 pc
Mouse	1 pc
16G USB flash disk	1 pc
White/black plate	1 pc
Network cable	1 pc
Shortcut keyboard	1 pc



16G USB flash disk
(included)

OPTIONAL ACCESSORY

0.5X auxiliary objective *	5325-VM100-OB05X
----------------------------	------------------

* Measurement is not recommended with 0.5X auxiliary objective

To be continued

Continued from previous page



shortcut keyboard (included)

Shortcut Keyboard Function

- Take picture: take a picture and save it
- Video: record a video
- Freeze: the image can be frozen
- Zoom+: increase the magnification
- Zoom-: reduce the magnification
- Mirror: image horizontal flip over
- Flip: image vertical flip over
- Zoom 1, 2, 3, 4: save the current magnification
- Brightness+: increase the brightness of the light
- Brightness-: reduce the brightness of the light

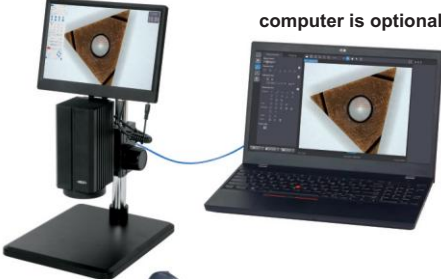

computer is optional

can be connected to display and computer at the same time

SOFTWARE FOR LCD (INCLUDED)

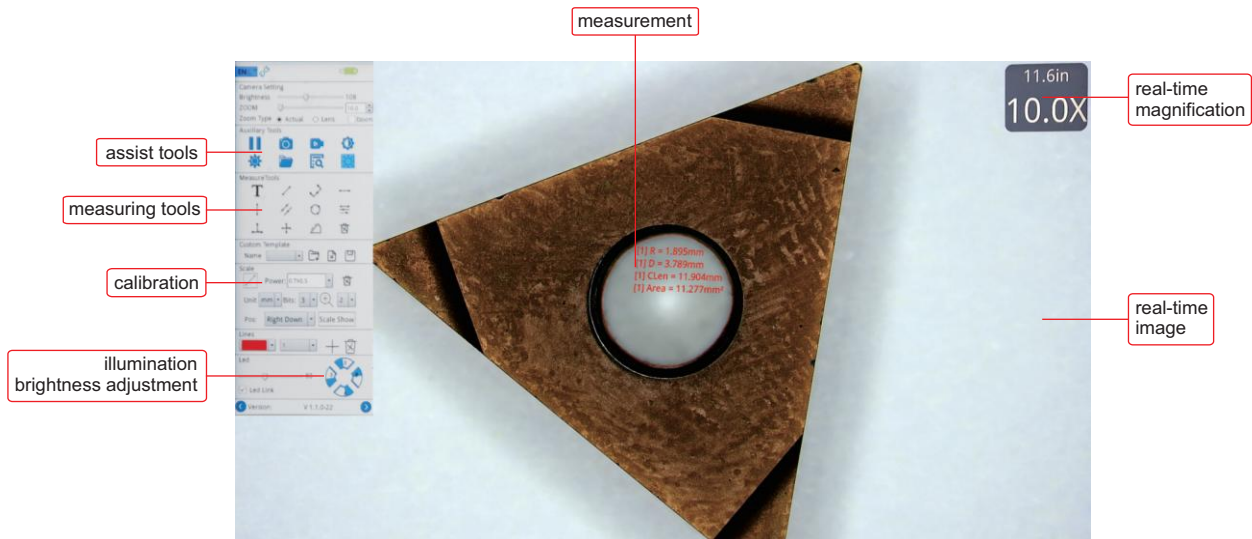

measurement

assist tools

measuring tools

calibration

illumination brightness adjustment

11.6in

10.0X

real-time magnification

real-time image

Measurement data:
 [1] R = 1.895mm
 [1] D = 3.789mm
 [1] CLen = 11.904mm
 [1] Area = 11.277mm²

SOFTWARE FOR COMPUTER (INCLUDED)

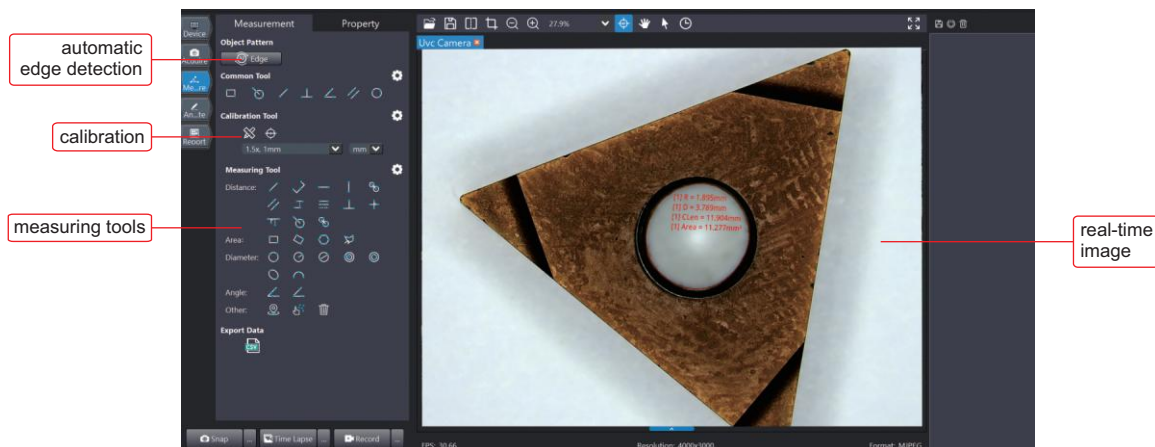

automatic edge detection

calibration

measuring tools

real-time image

Measurement data:
 [1] R = 1.895mm
 [1] D = 3.789mm
 [1] CLen = 11.904mm
 [1] Area = 11.277mm²

LARGE DEPTH OF VIEW DIGITAL MEASURING MICROSCOPE (ADVANCED TYPE) CODE 5322-ID250A

**FOCUS
STACKING**

**ELECTRONIC MAGNIFICATION
FEEDBACK LENS**

**PROGRAMMABLE
SEGMENTED RING LIGHT**



adjustable display angle



eight-zone LED ring light

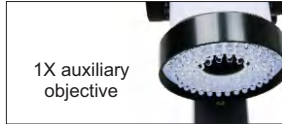

11.6" LCD (included)

USB ports
objective magnification
adjustment (0.7X~4.5X)

focus adjustment

power on/off

mouse

- Electronic magnification feedback lens: when the objective lens magnification is changed manually, the software automatically selects the corresponding pre-calibration data and calibration is not needed
- Send photos and measurement data via ethernet (TCP/IP)
- Digital magnification
- Can be connected to display and computer at the same time
- Take pictures, save to USB flash disk
- Measuring results can be sent to Excel



16G USB flash disk (included)

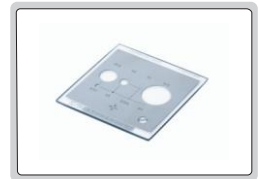

calibration plate (included)

SPECIFICATION

Sensor	1/2" CMOS
Pixel	2M
Resolution	1920×1080
Magnification	12~77X
Focus distance	60mm
View field	3.2×1.8~20.9×11.7mm
Max. workpiece height	53mm
Frame rate	60fps
Output	USB/HDMI/LAN
Power supply	power adapter
Dimension (L×W×H)	260×320×500mm
Weight	5.2kg

24

MAGNIFICATION AND MEASURING ACCURACY

Objective magnification	Magnification	Measuring accuracy
0.7X	12X	±9μm
1X	17X	±9μm
1.5X	26X	±8μm
2X	35X	±7μm
2.5X	43X	±7μm
3X	51X	±7μm
3.5X	60X	±6μm
4X	68X	±6μm
4.5X	77X	±5μm

focus stacking

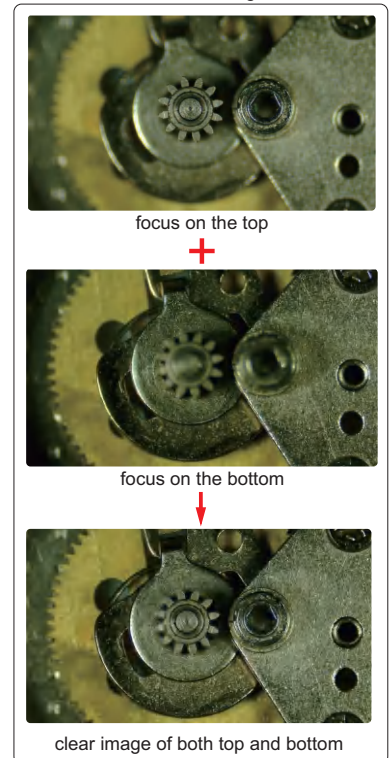

To be continued

Continued from previous page

STANDARD DELIVERY

Main unit	1 pc
Calibration plate	1 pc
Power adapter	1 pc
Mouse	1 pc
16G USB flash disk	1 pc

OPTIONAL ACCESSORY

0.5X auxiliary objective	5307-ID100A-OB05X
0.75X auxiliary objective	5307-ID100A-OB075X
2X auxiliary objective	5307-ID100A-OB2X

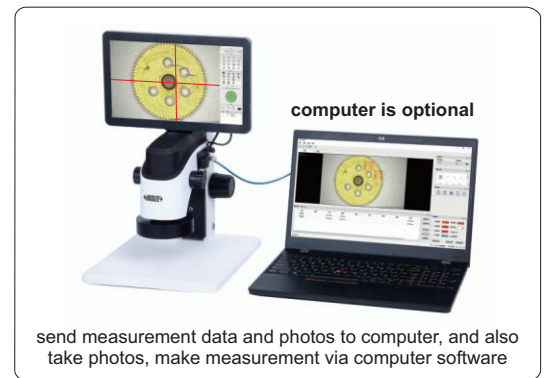

SOFTWARE FOR LCD (INCLUDED)

Refer to page 727 for details

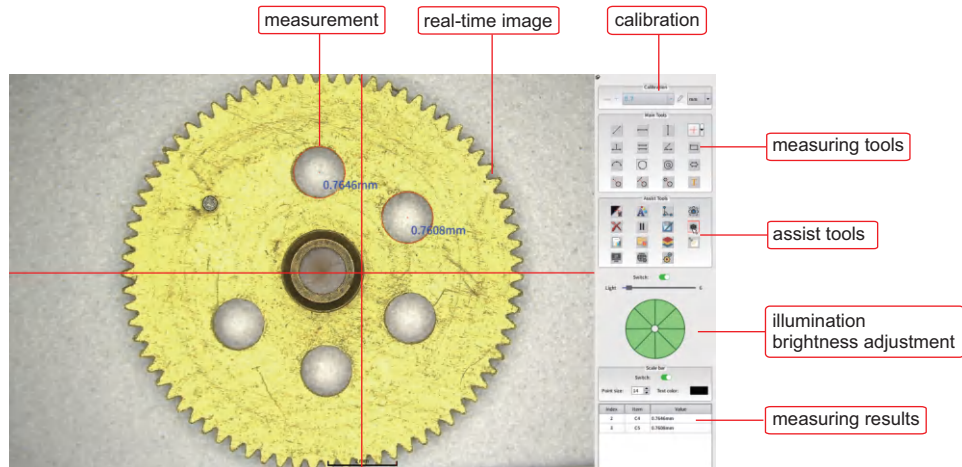

SOFTWARE FOR COMPUTER (INCLUDED)

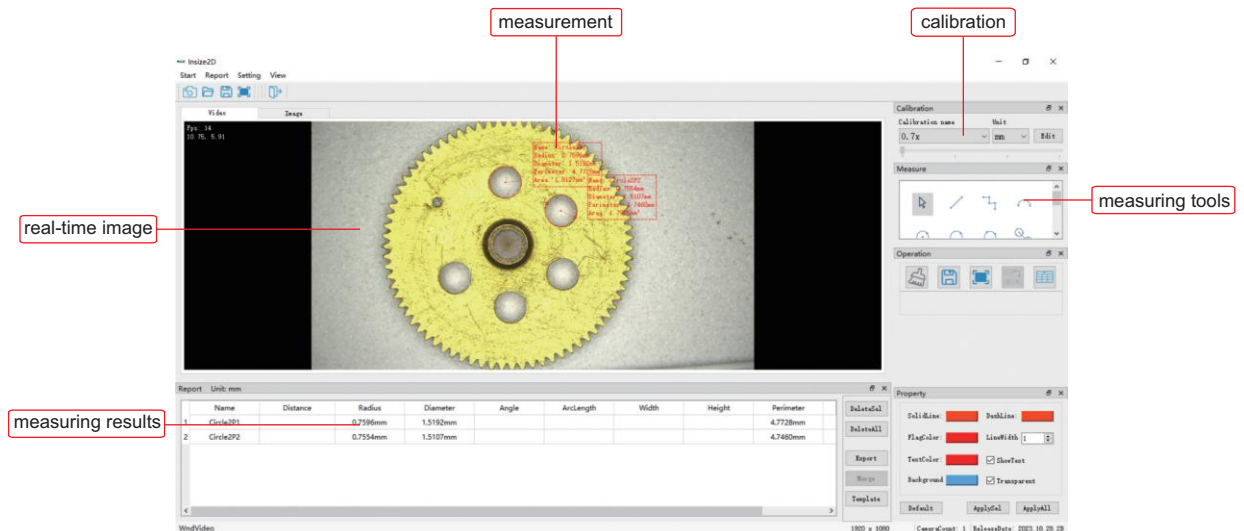

DIGITAL MEASURING MICROSCOPE (STANDARD TYPE) CODE 5307-ID100A

ELECTRONIC MAGNIFICATION
FEEDBACK LENS

BUILT-IN SOFTWARE
WITHOUT COMPUTER



- Electronic magnification feedback lens: when the objective lens magnification is changed manually, the software automatically selects the corresponding pre-calibration data and calibration is not needed
- Two methods of LED brightness adjustment, knob adjustment and software adjustment
- Built-in software without computer, operated by mouse
- Take pictures, save to USB flash disk
- Measuring results can be sent to Excel

adjustable display angle



LED ring light
1X auxiliary objective

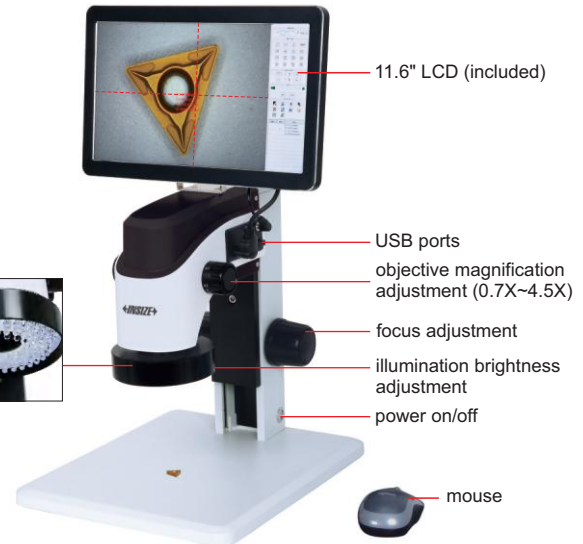

11.6" LCD (included)

USB ports
objective magnification adjustment (0.7X~4.5X)
focus adjustment
illumination brightness adjustment
power on/off

mouse

SPECIFICATION

Sensor	1/2" CMOS
Pixel	2M
Resolution	1920×1080
Magnification	12~77X
Focus distance	65mm
View field	3.2×1.8~20.9×11.7mm
Max. workpiece height	60mm
Frame rate	60fps
Output	USB/HDMI
Power supply	power adapter
Dimension (L×W×H)	260×320×500mm
Weight	5.2kg

STANDARD DELIVERY

Main unit	1 pc
Calibration plate	1 pc
Power adapter	1 pc
Mouse	1 pc
16G USB flash disk	1 pc

MAGNIFICATION AND MEASURING ACCURACY

Objective magnification	Magnification	Measuring accuracy
0.7X	12X	±9μm
1X	17X	±9μm
1.5X	26X	±8μm
2X	35X	±7μm
2.5X	43X	±7μm
3X	51X	±7μm
3.5X	60X	±6μm
4X	68X	±6μm
4.5X	77X	±5μm

OPTIONAL ACCESSORY

0.5X auxiliary objective	5307-ID100A-OB05X
0.75X auxiliary objective	5307-ID100A-OB075X
2X auxiliary objective	5307-ID100A-OB2X

SOFTWARE (INCLUDED)

- Refer to page 727 for details

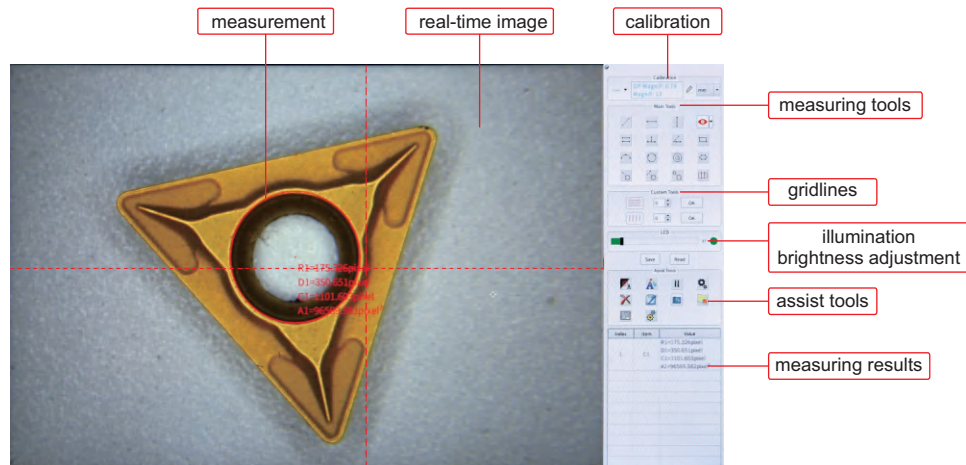

measurement

real-time image

calibration

measuring tools

gridlines

illumination brightness adjustment

assist tools

measuring results

NO CALIBRATION
AFTER ZOOM

TAKE PICTURES
AND VIDEOS

MEASUREMENT

MOTORIZED
ZOOM

AUTO FOCUS DIGITAL MICROSCOPE (ADVANCED TYPE) CODE 5319-AF290



MOTORIZED
LIGHT CONTROL

AUTO
FOCUS



16G USB flash disk
(included)

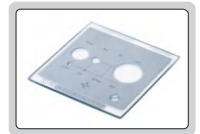

calibration plate
(included)

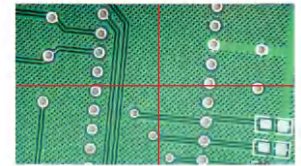

display cross hair and gridline
(blue/green/red/yellow/
black/white colors)

- Auto focus camera
- Take pictures and videos
- Built-in measuring software
- Automatic exposure and white balance
- Brightness, contrast ratio, gain are adjustable
- Display actual magnification
- Digital magnification
- Shortcut keyboard operation
- Display cross hair and gridline (blue/green/red/yellow/black/white colors)

SPECIFICATION

Magnification	27.4X~163X
Sensor	1/2.8" CMOS
Pixel	2M
Measuring accuracy	±0.02mm
Resolution	1920×1080
Frame rate	50/60fps
Output	HDMI
Power supply	power adapter
Dimension (L×W×H)	600×280×390mm
Weight	6.5kg

STANDARD DELIVERY

Main unit (with stand)	1 pc
21.5" LCD	1 pc
16G USB flash disk	1 pc
Mouse	1 pc
HDMI cable	1 pc
Calibration plate	1 pc
White/black plate	1 pc
Shortcut keyboard	1 pc
Power adapter	2 pcs

FOCUS DISTANCE AND VIEW FIELD

Optical magnification*	0.8X	1X	2X	3X	4X	4.76X
Focus distance	88~133mm	88~133mm	98~123mm	103~115mm	108~111mm	108~111mm
View field (mm)	19.4×11~15.8×8.8	15×8.3~12.7×7.2	7.1×4~6.7×3.8	4.8×2.7~4.5×2.5	3.6×2~3.3×1.8	3×1.7~2.8×1.6

* The optical zoom lens can be arbitrarily zoomed between 0.8X and 4.76X



shortcut keyboard
(included)

Shortcut keyboard function

- Take picture: take a picture and save it
- Video: record a video
- Freeze: the image can be frozen
- Manual focus-: reduce the manual focus value
- Manual focus+: increase the manual focus value
- Zoom+: increase the magnification
- Zoom-: reduce the magnification
- AF/MF: switch to auto focus or manual focus
- FBL: center the camera motor
- Mirror: image horizontal flipover
- Flip: image vertical flipover
- Focus: achieve one-key focus
- Zoom 1, 2, 3, 4: save the current magnification
- Brightness+: increase the brightness of the light
- Brightness-: reduce the brightness of the light

SOFTWARE (INCLUDED)

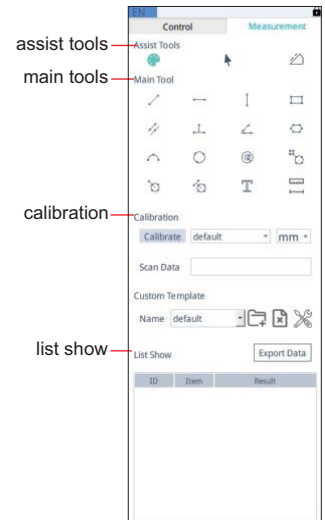
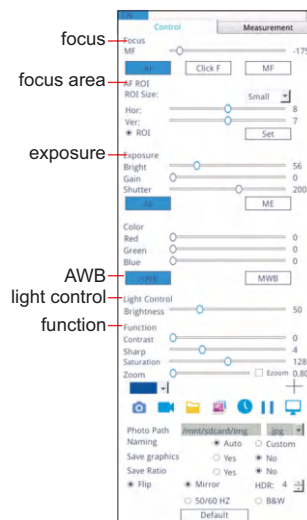

SMART MICROSCOPE CODE ISM-DL400

**AUTOMATICALLY LOCATE WORKPIECES
REGARDLESS OF POSITION AND DIRECTION**

**BUILT-IN SOFTWARE
WITHOUT COMPUTER**

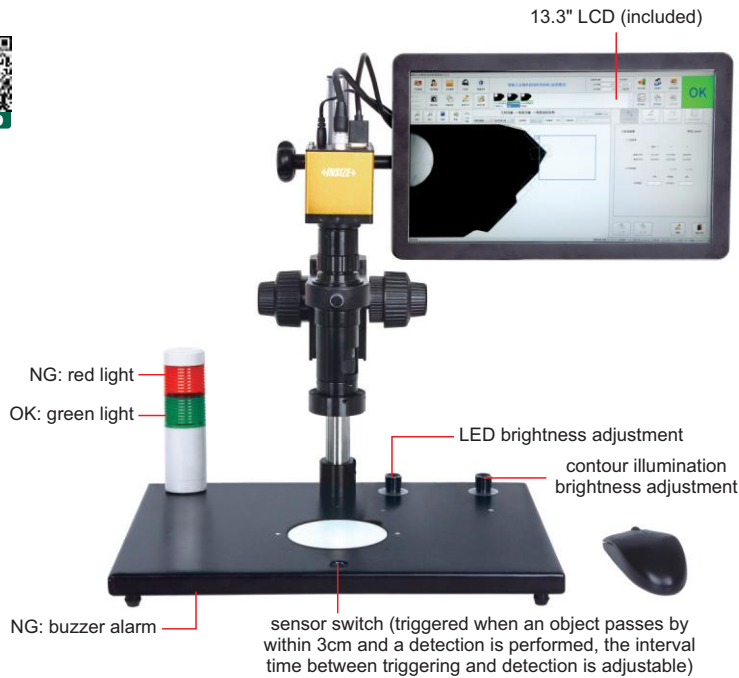

camera function

- surface defect detection
- dimension measurement
- read barcode
- burr detection
- contour matching
- character recognition
- color detection
- read QR code
- object counting
- thread measurement

detect different workpieces at one time

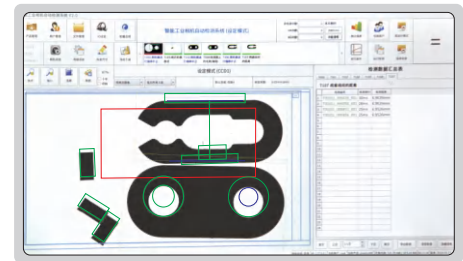

- Automatically identify different workpieces
- Automatically locate workpieces regardless of position and direction
- Built-in software, PLC control input and output interface
- Including multiple detection tools
- Automatically calculate, store the test results and sent to Excel

Serial	Workpiece	Dimension (mm)	OK Count	NG Count	Yield Rate	Detection Rate
T101	Point distance	400	200	200	50.00%	40.00%
T102	Cluster	500	250	250	50.00%	20.00%
Summary		400	200	200	40.00%	30.00%

report showing the perform times of each tool, quantity of OK and NG, the report can be saved

Serial	Tool	Tool			
T102 Cluster					
Serial	Detection number	Detection time	Detection color	Number of spots	Maximum value
1	790101_00041_001	31ms	白色	0	0.0000mm
2	790101_001151_001	31ms	白色	0	0.0000mm
3	790101_001102_001	31ms	白色	0	0.0000mm
4					
5					
6					
7					
8					
9					
10					
11					
12					

report of each detection is automatically created and saved

SPECIFICATION

Magnification	15X~100X
Resolution	1920×1080
Pixel	2M
Single pixel size	3.75×3.75μm
Frame rate	60fps
Sensor	1/2" CMOS
Chip structure	FPGA+ARM
Operation system	Linux 3.10
Power supply	power adapter
Dimension (L×W×H)	570×300×430mm
Weight	6.5kg

STANDARD DELIVERY

Main unit	1 pc
0.5X camera adapter	1 pc
1X auxiliary objective	1 pc
Calibration plate	1 pc
16G USB flash disk	1 pc
White/black plate	1 pc
HDMI cable	1 pc
Power adapter	3 pcs

MAGNIFICATION, FOCUS DISTANCE AND VIEW FIELD

Auxiliary objective	Specification	Camera adapter	
		0.5X (included)	1X (optional)
1X (included)	magnification	15~100X	30~200X
	focus distance	70±2mm	70±2mm
	view filed	16×11~2.5×1.6mm	7.8×5.3~1.2×0.8mm
2X (optional)	magnification	30~200X	60~400X
	focus distance	29±2mm	29±2mm
	view filed	7.8×5.3~1.2×0.8mm	3.8×2.7~0.6×0.4mm

OPTIONAL ACCESSORY

1X camera adapter	ISM-DL-CA1X
2X auxiliary objective	ISM-DL-OB2X
LED light	page 728~729
Auxiliary objective	page 730

To be continued

Continued from previous page

■ APPLICATION EXAMPLES:

dimension measurement

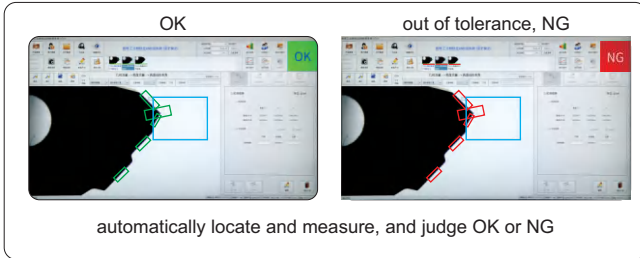

thread measurement

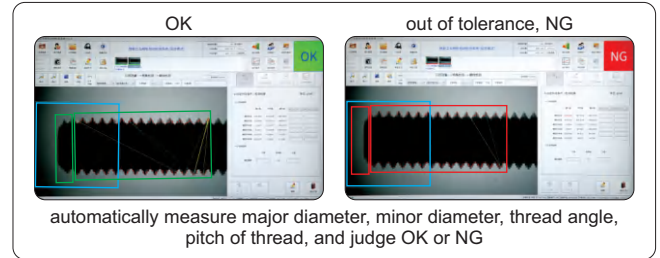

cutting tools measurement

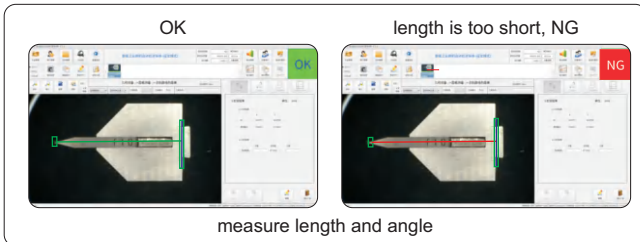

counting

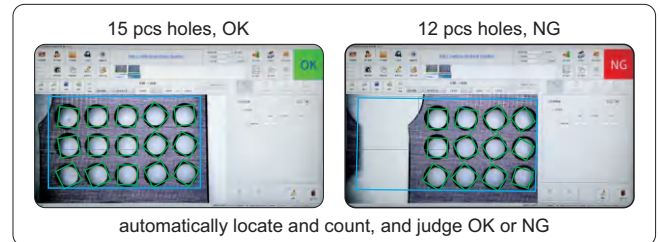

existence or absence

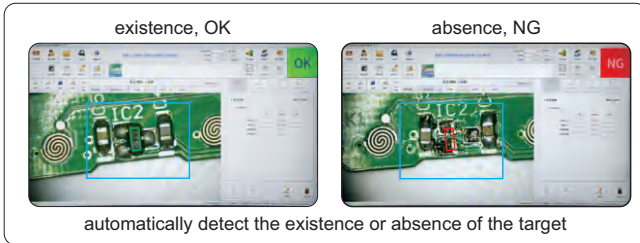

character recognition

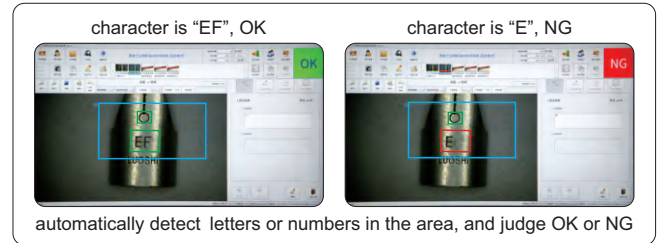

color detection



location detection

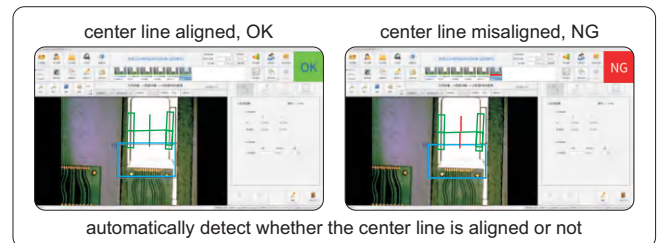

surface defect detection

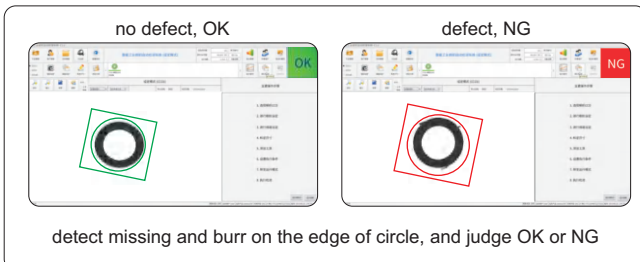

glue detection

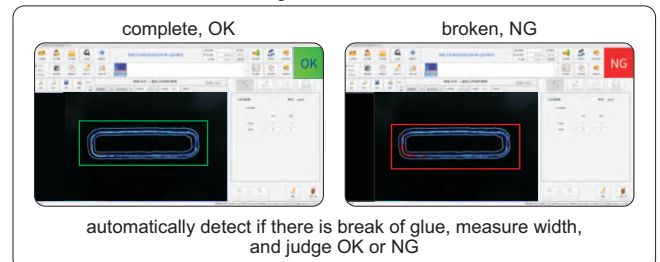

MEASURING SOFTWARE OF DIGITAL MICROSCOPES

SOFTWARE CAN BE CUSTOMIZED

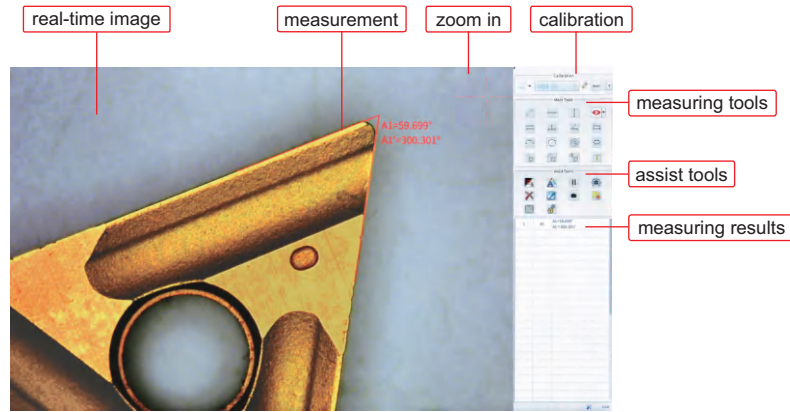

- Included in digital microscopes (ISM-DL300, ISM-DL301, 5310-DL401, ISM-DL302, ISM-DL510, ISM-DL520, 5307-ID100A, 5322-ID250A)

- Language: Simplified Chinese, Traditional Chinese, English, Korean

▪ Calibration:

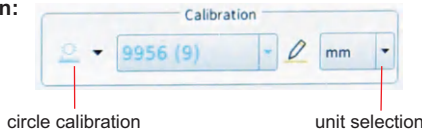

▪ Edge-detection:

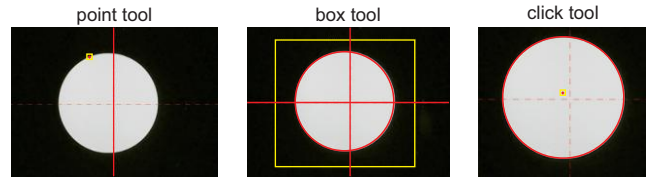

▪ Measurement tools:

- | | | | | | |
|--|--|--|---|--|---|
| | measure length of line or distance between two points | | measure length of line or distance between two points in horizontal direction | | measure length of line or distance between two points in vertical direction |
| | measure angle from horizontal line | | measure angle from vertical line | | measure angle of two lines |
| | measure distance between two parallel lines | | measure distance between two parallel lines | | measure distance between multiple parallel lines |
| | measure distance between point and line | | measure radius, length and angle of arc | | measure girth and area of polygon |
| | measure radius, diameter, girth and area of circle with three points | | measure radius, diameter, girth and area concentric of circles | | measure length, width, girth and area of rectangle |
| | measure minimum distance between point and circle | | measure distance between point and center of circle | | measure maximum distance between point and circle |
| | measure minimum distance between line and circle | | measure distance between line and center of circle | | measure maximum distance between line and circle |
| | measure minimum distance between two circles | | measure center distance between two circles | | measure maximum distance between two circles |
| | add text | | measure radius, diameter, girth and area of circle with two points | | cross hair and graduated cross hair |

▪ Assist tools:

- | | | | |
|--|--------------------------------------|--|-----------------------------------|
| | manual/automatic point selection | | delete images |
| | line width and color settings | | export measurement data to U disk |
| | freeze screen | | take pictures and save |
| | camera parameter settings | | review pictures |
| | layout settings of measurement items | | system settings |

▪ Cross hair:

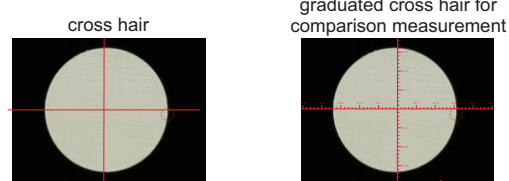

▪ Grid comparison measurement:



full-screen grid for comparison measurement, adjustable grid number

▪ Output to Excel:

1	A1	A1=59.699°
		A1=300.301°

X-Y METAL STAGE CODE ISM-DL-STAGE1

- Suitable for digital microscopes 5301-D400, 5303-AF103, 5310-DL401, 5313-S407, 5315-S710, 5318-MD60-XY 5324-K210, ISM-DL300, ISM-DL301, ISM-DL302, ISM-DL520

SPECIFICATION

X-Y travel range	100×86mm
Dimension (L×W×H)	180×180×50mm
Weight	2.3kg

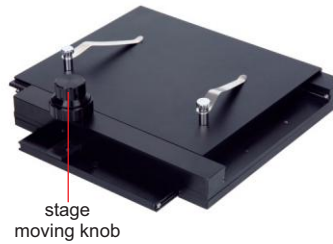

RED, GREEN, BLUE, INFRARED AND UV LIGHT CAN BE CUSTOMIZED

ATTENTION: MUST BE USED WITH LIGHT BRACKET AND LIGHT CONTROLLER

LED RING LIGHT CODE ISM-LED-9245R

- Diffuser plate is included to reduce the reflective effect on workpieces
- Suitable for digital microscopes 5303-AF103, 5310-DL401, ISM-DL300, ISM-DL301, ISM-DL302, ISM-DL400, ISM-DL510, 5315-S710

SPECIFICATION

Light color	white
Power supply	24V
Power	5.5W
Angle	45°
Outside/inside diameter	92/52mm

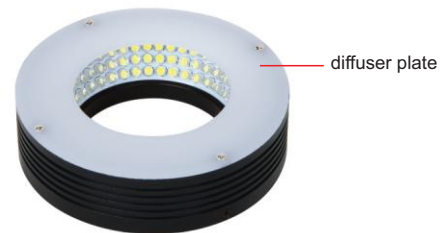

RED, GREEN, BLUE, INFRARED AND UV LIGHT CAN BE CUSTOMIZED

ATTENTION: MUST BE USED WITH LIGHT BRACKET AND LIGHT CONTROLLER

LED SQUARE LIGHT CODE ISM-LED-100L4

- Diffuser plate is included to reduce the reflective effect on workpieces
- Angle and brightness can be adjusted independently
- Suitable for digital microscopes 5303-AF103, 5310-DL401, ISM-DL300, ISM-DL301, ISM-DL302, ISM-DL400, ISM-DL510, 5315-S710

SPECIFICATION

Light color	white
Power supply	24V
Power	10.36W
Angle	0~90°
Dimension (L×W×H)	154×154×30mm

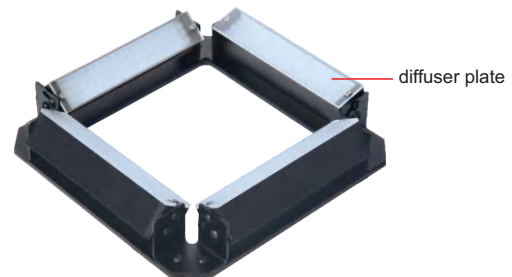

DIGITAL LIGHT CONTROLLER CODE ISM-LED-CTRL

- 256 (0-255) steps of brightness adjustment
- With power off memory function and short circuit protection function
- Suitable for ISM-LED-100L4, ISM-LED-9245R

SPECIFICATION

Power supply	100~240V, 50/60HZ
Output power (rated)	60W
Output voltage (rated)	24V
Dimension (L×W×H)	145×118×83mm

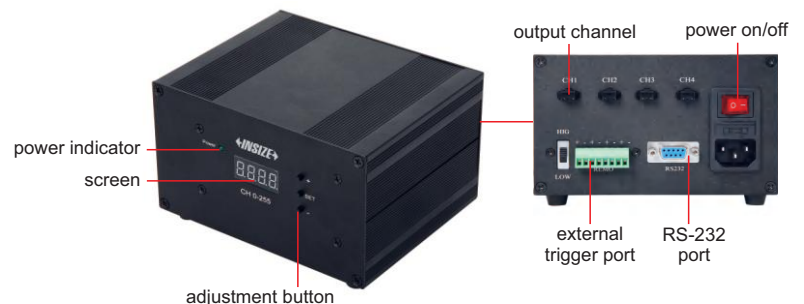

BRACKET FOR LIGHTS CODE ISM-LED-BRACKET

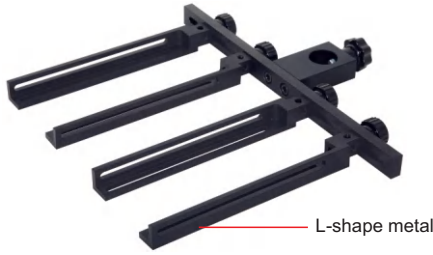

L-shape metal

- 4 pcs L-shape bars are included, multiple combinations can be realized
- Suitable for ISM-LED-100L4, ISM-LED-9245R

application



SPECIFICATION

Size (L×W×H)	260×300×20mm
Weight	0.7kg

DUAL HEAD LED LIGHT CODE ISM-ZS-LED

- Adjustable illumination
- For digital and stereo microscopes

SPECIFICATION

Power	3W
Power supply	100~240V
Working	10000h
Illumination	10000lux



application



LED AUXILIARY LIGHT CODE ISM-DL-LED

- Suitable for digital microscopes
5303-AF103, 5310-DL401, ISM-DL300,
ISM-DL301, ISM-DL302, ISM-DL400,
ISM-DL510, 5315-S710

SPECIFICATION

Power	8W
Diameter of mounting hole	Ø25mm
Power supply	10~12V, 0~300mA



brightness adjustment knob



illumination direction and brightness are adjustable

COAXIAL LIGHT CODE ISM-DL-COAXIAL

- Suitable for digital microscopes
5303-AF103, 5310-DL401, ISM-DL300,
ISM-DL301, ISM-DL302, ISM-DL400,
ISM-DL510, 5315-S710

SPECIFICATION

Power	1W
Power supply	0~3.4V, 0~400mA



brightness adjustment knob



for smooth surfaces and small holes, brightness is adjustable

AUXILIARY OBJECTIVES



0.3X auxiliary objective*
ISM-DL-OB03X



0.5X auxiliary objective*
ISM-DL-OB05X



0.75X auxiliary objective*
ISM-DL-OB075X



1X auxiliary objective
ISM-DL-OB1X



1.5X auxiliary objective
ISM-DL-OB1D5X



2X auxiliary objective
ISM-DL-OB2X

- Suitable for digital microscopes 5303-AF103, 5310-DL401, ISM-DL300, ISM-DL301, ISM-DL400, ISM-DL510, 5315-S710, 5317-AF109, 5317-AF110

MAGNIFICATION, FOCUS DISTANCE AND VIEW FIELD (5303-AF103)

Auxiliary objective	Specification	Camera adapter	
		0.5X (included)	1X (optional)
0.3X (optional)	magnification	6~37X	12~74X
	focus distance	120~310mm	120~310mm
	view field	52×30~8×5mm	26×15~4×2.5mm
0.5X (optional)	magnification	10~61X	20~123X
	focus distance	78~230mm	78~230mm
	view field	37×20~5×3mm	18×10~2.5×1.5mm
0.75X (optional)	magnification	15~92X	30~184X
	focus distance	60~125mm	60~125mm
	view field	21×13~3.4×2mm	10×6.5~1.7×1mm
1X (included)	magnification	20~123X	40~246X
	focus distance	48~84mm	48~84mm
	view field	15×8~2.5×1.5mm	7.5×4~1.3×0.7mm
1.5X (optional)	magnification	30~184X	60~368X
	focus distance	36~63mm	36~63mm
	view field	10×6~1.7×1mm	5×3~0.9×0.5mm
2X (optional)	magnification	40~246X	80~492X
	focus distance	24~42mm	24~42mm
	view field	7.5×4~1.3×0.7mm	3.8×2~0.7×0.4mm

MAGNIFICATION, FOCUS DISTANCE AND VIEW FIELD (ISM-DL300, ISM-DL301, ISM-DL510)

Auxiliary objective	Specification	Camera adapter	
		0.5X (included)	1X (optional)
0.3X (optional)	magnification	5~34X	10~68X
	focus distance	287±2mm	287±2mm
	view field	42×26~6.5×4.5mm	21×13~3.3×2.3mm
0.5X (optional)	magnification	9~56X	18~112X
	focus distance	166±2mm	166±2mm
	view field	25.6×16.8~5×3.5mm	12.8×8.4~2×1.3mm
0.75X (optional)	magnification	13~84X	26~168X
	focus distance	105±2mm	105±2mm
	view field	17×10.5~2.6×1.7mm	8.5×5.3~1.3×0.9mm
1X (included)	magnification	15~100X	30~200X
	focus distance	70±2mm	70±2mm
	view field	16×11~2.5×1.6mm	7.8×5.3~1.2×0.8mm
1.5X (optional)	magnification	26~168X	52~336X
	focus distance	42±2mm	42±2mm
	view field	8.5×5.2~1.3×0.9mm	4.3×2.6~0.7×0.5mm
2X (optional)	magnification	30~200X	60~400X
	focus distance	29±2mm	29±2mm
	view field	7.8×5.3~1.2×0.8mm	3.8×2.7~0.6×0.4mm

- * For auxiliary objectives 0.3X, 0.5X, 0.75X, use contour illumination of ISM-DL301, ISM-DL400, ISM-DL510, 5310-DL401 or LED light

MINI DIGITAL MICROSCOPE (ECONOMIC TYPE) CODE 5311-M710

TAKE PICTURES
AND VIDEOS

BUILT-IN
LITHIUM BATTERY

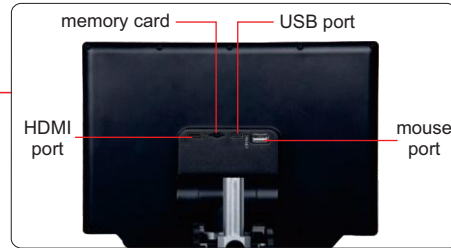

32G memory card and holder (included)



infrared ray remote controller (included)

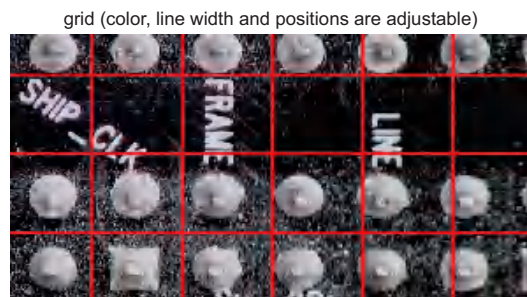
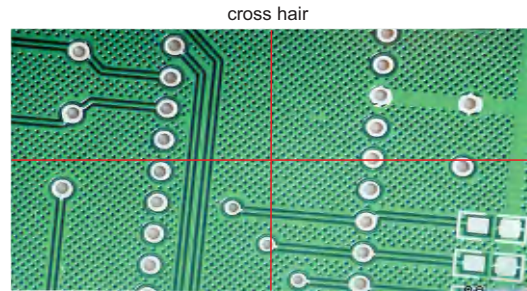
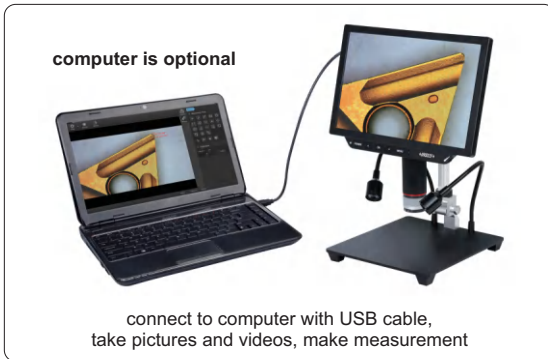

SPECIFICATION

Display resolution	1280×800
Sensor	1/3" CMOS
Pixel	13M
Single pixel size	1.12μm×1.12μm
Frame rate	60fps/30fps
Magnification	6.5X~60X
View field	3.6×2~33×18.5mm
White balance	auto/manual (10 levels RGB)/calibration
Exposure control	AE lock/exposure compensation (10 levels)
Image control	contrast/saturation/sharpness (10 levels)
Record media	memory card (128G Max)
Output	HDMI
Power supply	power adapter
Dimension (LxWxH)	180×200×360mm
Weight	1.3kg

STANDARD DELIVERY

Main unit	1 pc
USB cable	1 pc
HDMI cable	1 pc
IR remote controller	1 pc
32G memory card and holder	1 pc
Plastic calibration ruler	1 pc
Power adapter	1 pc

To be continued

Continued from previous page

▪ **Screen freezing:**

full screen

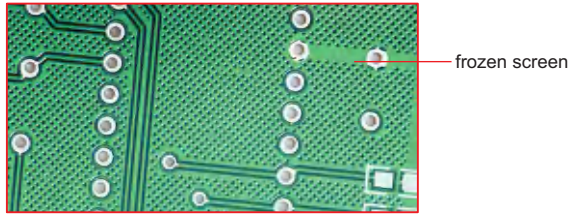

up-down split screen

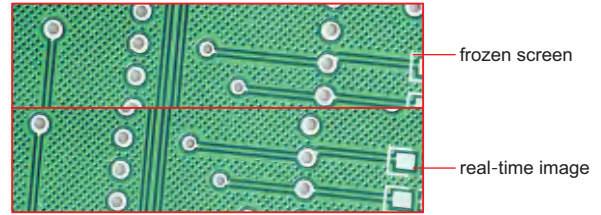

left-right split screen

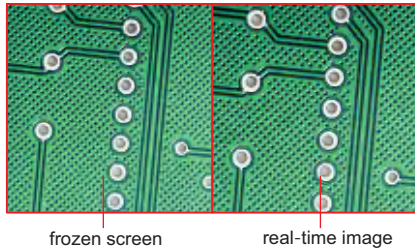

1/4 split screen

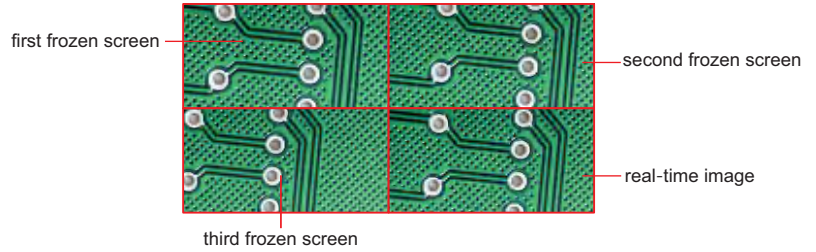

SOFTWARE FOR COMPUTER (INCLUDED)

- **Language:** Chinese (Simplified), English
- **Operation system:** Windows 7/8/8.1/10 (64bit)
- **Port:** USB2.0 or above
- **Measuring accuracy:** 0.02mm

- | | | | |
|------------------------------|--------------------------------------|---------------------------------|---|
| point counting | straight line length | continuous line length | area of a rectangle |
| area of a polygon | distance between 2 lines | distance between parallel lines | distance between line and first parallel line |
| point-line distance | cross line | double cross line | angle |
| arc | radius of a circle | radius of a 2-point circle | radius of a 3-point circle |
| center distance of 2 circles | center distance of concentric circle | | |

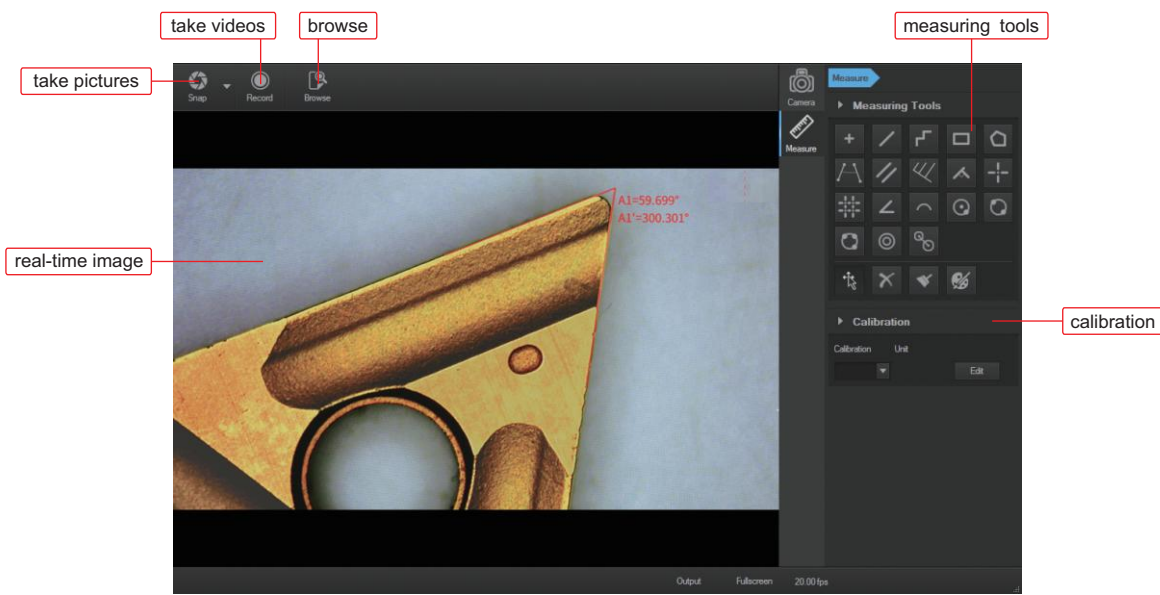

DIGITAL MEASURING MICROSCOPES (ECONOMIC TYPE)

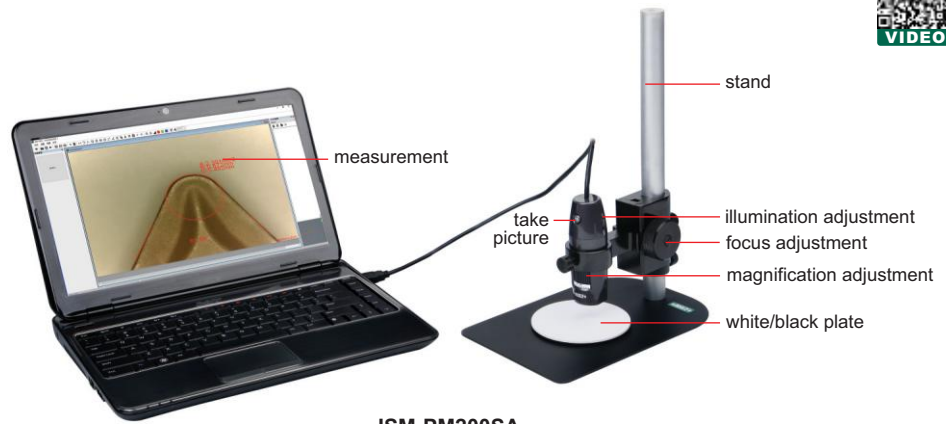
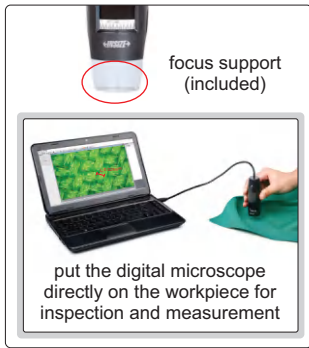

ISM-PM200SA
computer is optional

- Can take pictures and videos
- Supplied with software
- Calibration rulers (graduation 0.1 and 1mm) are included
- With focus support

SPECIFICATION

Code	ISM-PM200SA	ISM-PM200SB
Magnification	10X~200X	10X~200X
Stand	standard	universal
Pixel	2M (resolution: 1920×1080)	
Illumination	built-in adjustable LED	
Power supply	USB 2.0 cable (voltage required: 5±0.1V)	

software flash disk (included)



filter (optional)



MAGNIFICATION, FOCUS DISTANCE, VIEW FIELD AND ACCURACY

Magnification	Focus distance	View field	Accuracy
50X	22mm	9.6×7.1mm	30μm
100X	14mm	4.8×3.6mm	15μm
150X	14mm	3.3×2.5mm	10μm
200X	19mm	2.3×1.8mm	8μm

universal stand (included in ISM-PM200SB)



STANDAER DELIVERY

Main unit	1 pc
USB flash disk	1 pc

OPTIONAL ACCESSORY

Green filter	ISM-PM-GREEN
Yellow filter	ISM-PM-YELLOW
Blue filter	ISM-PM-BLUE

SOFTWARE

- Language:** English, Japanese, Ukrainian, German, French, Italian, Spanish, Chinese
- Operation system:** Windows 7/8/XP/Vista
- Measuring tools:**

- measure radius, diameter, girth and area of circle with two points
- measure area of polygon
- measure distance between two circles
- measure distance between two parallel lines
- measure angle with two lines
- measure distance between point and line

- measure radius of arc
- measure radius of circle
- measure length of continuous line
- measure angle with three points
- measure radius, girth and area of circle
- add text

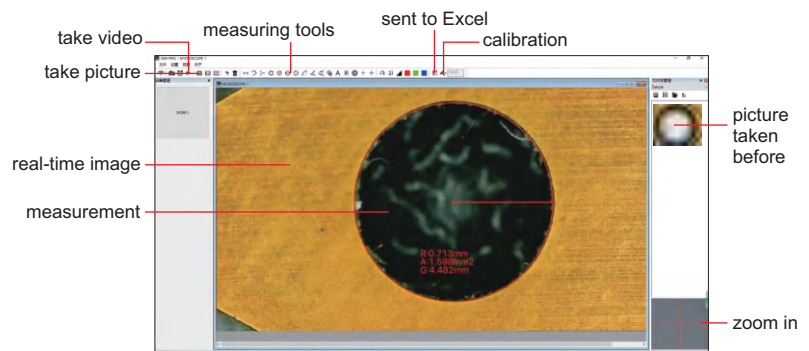

- Data is sent to Excel:**

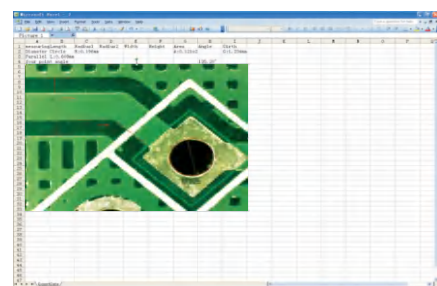



WIFI DIGITAL MEASURING MICROSCOPE (ECONOMIC TYPE) CODE ISM-WF200

- Maximum working distance is 5m under WIFI mode
- Can be connected to multiple iPads, Android devices or computers together under WIFI mode
- Take pictures and videos
- Supplied with software



stand (code ISM-PM-STAND, optional)



software flash disk (included)

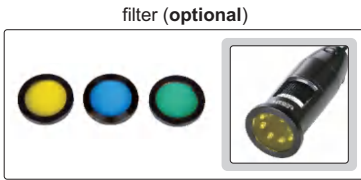

plastic calibration ruler (graduation 1mm, included)

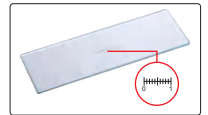

glass calibration ruler (graduation 0.1mm, included)

SPECIFICATION

Magnification	10X~200X
Pixel	1.3M (resolution: 1280×1024)
Illumination	built-in adjustable LED
Power supply	built-in rechargeable battery

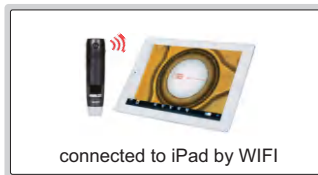

connected to iPad by WIFI

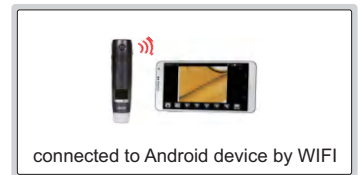

connected to Android device by WIFI

STANDARD DELIVERY

Microscope	1 pc
Focus support ring for 80X/150X	1 pc
Focus support ring for 60X/200X	1 pc
Glass calibration ruler (graduation 0.1mm)	1 pc
Plastic calibration ruler (graduation 1mm)	1 pc
Software and USB cable	1 pc
AC/DC adapter	1 pc



connected to computer by WIFI



connected to computer by USB cable

OPTIONAL ACCESSORY

Stand	ISM-PM-STAND
Green filter	ISM-PM-GREEN
Yellow filter	ISM-PM-YELLOW
Blue filter	ISM-PM-BLUE

MAGNIFICATION, FOCUS DISTANCE, VIEW FIELD AND ACCURACY

Magnification	Focus distance	View field	Accuracy
50X	21mm	8.1×6.4mm	30μm
100X	13mm	3.9×3.1mm	15μm
150X	16mm	2.6×2.1mm	10μm
200X	19mm	1.8×1.5mm	8μm

1 Software ISM-WF200 (for iPad by WIFI)

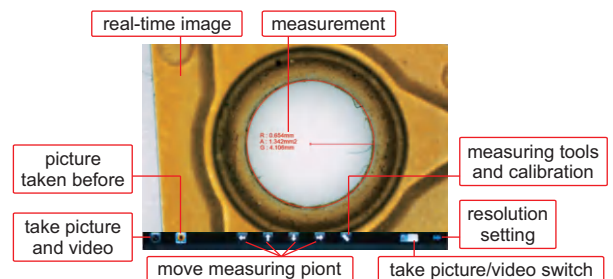

- measure length of line or distance between two points
- measure radius, girth and area of circle with three points
- measure angle



To be continued







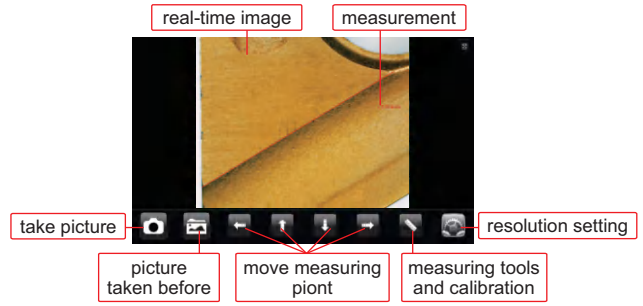



Continued from previous page

2 Software ISM-APK (for Android devices by WIFI)

-  measure length of line or distance between two points
-  measure radius, girth and area of circle with three points
-  measure angle







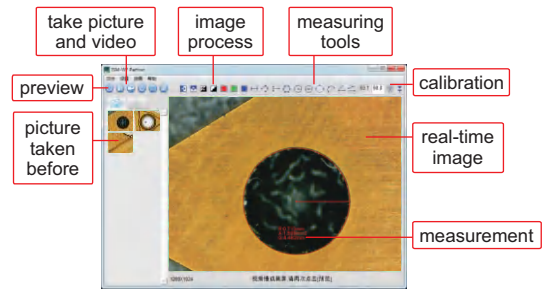







3 Software ISM-WF Partner (for computer by WIFI)

- | | |
|--|--|
|  measure length of line or distance between two points |  measure angle with two lines |
|  measure area of polygon |  measure radius, girth and area of circle with two points |
|  measure angle with three points |  measure distance between point and line |
|  measure radius, girth and area of circle with center point |  measure radius, length and angle of arc |
|  measure length of continuous line |  measure area of rectangle |
|  measure radius, girth and area of circle with three points | |



4 Software ISM-PRO (for computer by USB cable)

Measuring tools:

- | | |
|---|---|
|  measure length of line or distance between two points |  measure distance between point and line |
|  measure length of continuous line |  measure area of rectangle |
|  measure radius, length and angle of arc |  measure angle with two lines |
|  measure distance between two circles |  add number with circle |
|  measure distance between two parallel lines |  measure angle with three points |
|  measure radius, girth and area of circle |  add text |

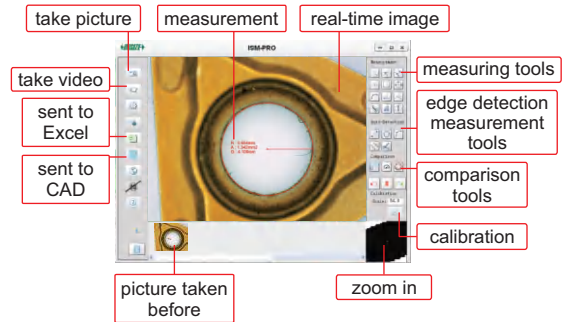

Edge detection measurement tools:

- | | |
|--|--|
|  detect line automatically, and calculate length |  detect two lines automatically, and calculate angle |
|  detect arc automatically, and calculate radius, angle and arc length |  detect two parallel lines automatically and calculate distance |
|  detect circle automatically, and calculate radius, girth and area | |

Comparison tools:

Create line, angle or circle with desired size, to compare with workpieces

-  create line
-  create angle
-  create circle with tolerance



Data is sent to CAD or Excel:

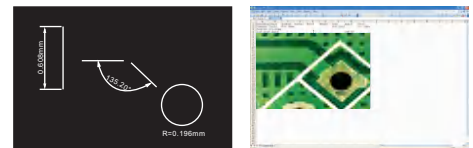

METALLURGICAL MICROSCOPES

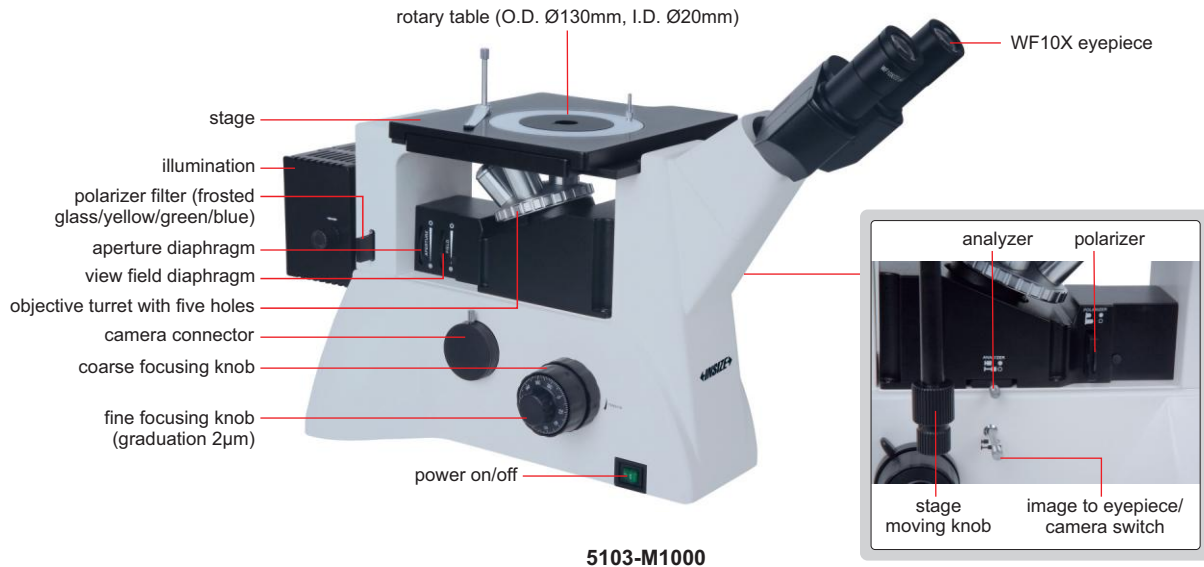

5103-M1000

- Infinite optical system, polarization observation
- Kohler illumination system provides uniform illumination field
- Objectives 50X, 100X are spring type

SPECIFICATION

Code	5103-M1000 (bright field objectives)				5103-M1000BD (bright & dark field objectives)			
Illumination	6V/30W halogen lamp, brightness is adjustable				12V/50W halogen lamp, brightness is adjustable			
Objective (infinite plan achromatic)	bright field objectives				bright & dark field objectives			
	10X	20X	50X	100X	5X	10X	20X	50X
Working distance	20.2mm	8.80mm	3.68mm	0.40mm	9.70mm	9.30mm	7.23mm	2.50mm
Numerical aperture	0.25	0.40	0.70	0.85	0.12	0.25	0.40	0.70
Magnification	100X~1000X				50X~500X			
Eyepiece (wide field)	10X (view field: Ø22mm)							
Stage	double layer							
	size: 242×200mm							
	travel: 30x30mm							
Pupil distance	53~75mm							
Diopter adjustment	±5 diopter (one eyepiece)							
Power supply	220V, 50/60Hz							
Dimension (L×W×H)	614×250×394mm							
Weight	13kg							

STANDARD DELIVERY

Main unit	1 pc
Polarizer and analyzer	1 pc of each
Anti-dust cover	1 pc

OPTIONAL ACCESSORY

Bright & dark field objective (for 5103-M1000BD)	PL40X	5101-M-BD40X
	PL60X	5101-M-BD60X
	PL80X	5101-M-BD80X
	PL100X	5101-M-BD100X
10X dividing eyepiece (0.1mm/div.)		5103-M-EPD10X
Bright field objective (for 5103-M1000)	PL5X	5101-M-OB5X
	PL40X	5101-M-OB40X
	PL60X	5101-M-OB60X
	PL80X	5101-M-OB80X
Digital camera		ISM-CM63
Camera adapter *		5101-M-ADAPTER

*Digital camera must be used with camera adapter

METALLURGICAL MICROSCOPES (ADVANCED TYPE)

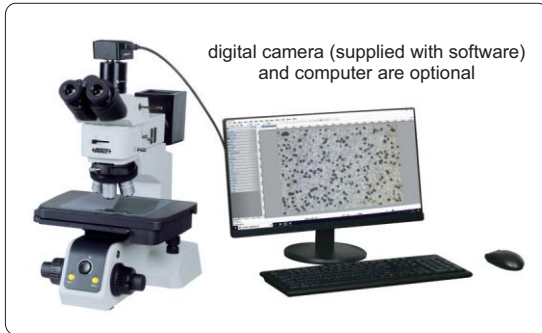

- Infinite chromatic aberration correction optical system
- Three way observation tube with infinite hinge
- Translucent and reflective frame, front low-hand position coarse and fine coaxial focus adjustment mechanism, with adjustment elastic device to prevent sliding and random upper limit device
- Bright and dark field five-hole converter with DIC slot
- Adopt digital dimming, with light intensity reset and setting function
- With polarizer insert plate and 360° rotating analyzer insert slot



5108-M3000

SPECIFICATION

Code	5108-M3000 (standard type)				5108-M3000H (high-definition type)			
Eyepiece	high eye point large field SWH10X-H (view field: Ø25mm, adjustable visibility)							
Objective (infinite long working distance bright and dark field semi achromatic)	5X	10X	20X	50X	5X	10X	20X	50X
Working distance	15mm	8.4mm	10.3mm	3.0mm	20mm	11mm	3.0mm	1.0mm
Numerical aperture	0.15	0.30	0.40	0.75	0.15	0.30	0.45	0.80
Optical magnification	50X~500X (up to 1000X with optional 100X objective)							
Digital magnification	170X~1700X (on 21.5" monitor), up to 3400X with optional 100X objective							
Stage	double layer							
	size: 310×240mm							
	travel: 150×100mm							
Condenser	roll-out achromatic condenser (numerical aperture 0.9)							
Illumination	5W LED, transmitted and reflected							
Observation tube	inverse image, distance adjustment: 50~76mm, two grade spectral ratio binocular: trinocular=100:0							
Diopter adjustment	±5 diopter (two eyepieces)							
Power supply	AC 100-240V							
Dimension (L×W×H)	310×600×500mm							
Weight	27kg							

STANDARD DELIVERY

Main unit	1 pc
Anti-dust cover	1 pc
0.65X camera adapter (adjustable focus)	1 pc
Polarizer and analyzer	1 pc of each

OPTIONAL ACCESSORY

Camera and software	ISM-CM63
Glass calibration ruler	ISM-MAS-SCALE
Computer	5108-M-COMPUTER
2.5X infinite long working distance bright field semi achromatic objective	5108-M-OB2D5X
100X infinite long working distance bright and dark field semi achromatic objective	5108-M-BD100X
50X infinite long working distance bright and dark field achromatic objective	5108-M-APO50X
100X infinite long working distance bright and dark field achromatic objective	5108-M-APO100X
Differential interference module (DIC)	5108-M-DIC



METALLURGICAL MICROSCOPE (STANDARD TYPE) CODE 5110-M900

- Infinite chromatic aberration correction optical system
- Three way observation tube with infinite hinge
- Translucent and reflective frame, front low-hand position coarse and fine coaxial focus adjustment mechanism, with adjustment elastic device to prevent sliding and random upper limit device
- With brightness memory function

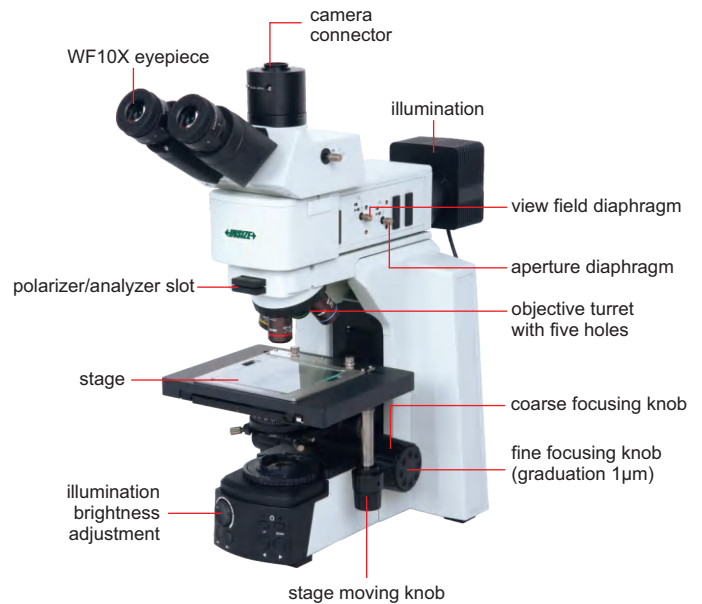

SPECIFICATION

Eyepiece	high eye point large field SWH10X-H (view field: Ø23mm, adjustable visibility)			
Objective (infinite long working distance semicomplex achromatic)	bright field objectives			
	5X	10X	20X	50X
Numerical aperture	0.15	0.30	0.45	0.70
Working distance	13.5mm	10.3mm	3.0mm	2.5mm
Optical magnification	50X~500X (up to 1000X with optional 100X objective)			
Digital magnification	100X~1000X (on 21.5" monitor), up to 2000X with optional 100X objective			
Stage	double layer glass workbench size: 101×101mm travel: 75×50mm			
Condenser	roll-out achromatic condenser (numerical aperture 0.9)			
Diopter adjustment	±5 diopter (two eyepieces)			
Illumination	10W adjustable LED, transmitted and reflected			
Observation tube	inverse image, distance adjustment: 50~75mm, two grade spectral ratio binocular: trinocular=100:0			
Power supply	power adapter			
Dimension (L×W×H)	255×510×530mm			
Weight	25kg			

STANDARD DELIVERY

Main unit	1 pc
Anti-dust cover	1 pc
0.5X camera adapter	1 pc

OPTIONAL ACCESSORY

Camera and software	ISM-CM63, ISM-KM60, ISM-MP8B, ISM-ZS70
Glass calibration ruler	ISM-MAS-SCALE
Computer	5110-M-COMPUTER
Polarizer and analyzer	5110-M-POA
100X infinite long working distance bright field semi-apochromatic objective	5110-M-BD100X

METALLURGICAL MICROSCOPES (BASIC TYPE)



5102-M600

- Infinite optical system, observation in reflected or transmitted illumination, polarizing observation
- Kohler illumination system provides uniform illumination field
- Objectives 40X, 60X are spring type

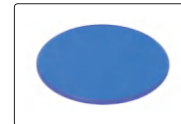

blue filter (included)



frosted glass filter (included)

SPECIFICATION

Code	5102-M600 (bright field objectives)				5102-M600BD (bright & dark field objectives)			
illumination	6V/30W (transmitted)		6V/30W (reflected)		12V/30W (transmitted)		12V/50W (reflected)	
Objective (infinite plan achromatic)	bright field objectives				bright & dark field objectives			
	5X	10X	40X	60X	5X	10X	20X	40X
Working distance	26.1mm	20.2mm	3.98mm	3.18mm	9.70mm	9.30mm	7.20mm	3.00mm
Numerical aperture	0.12	0.25	0.60	0.70	0.12	0.25	0.40	0.70
Magnification	50X~600X				50X~400X			
Eyepiece (wide field)	10X (view field: Ø22mm)							
Stage	double layer							
	size: 210×140mm							
	travel: 75×50mm							
Pupil distance	53~75mm							
Diopter adjustment	±5 diopter (one eyepiece)							
Power supply	220V, 50/60Hz							
Dimension (L×W×H)	456×260×498mm							
Weight	11kg							

STANDARD DELIVERY

Main unit	1 pc
Anti-dust cover	1 pc
Filter (blue/frosted glass)	1 pc of each

OPTIONAL ACCESSORY

Bright & dark field objective (for 5102-M600BD)	PL50X	5101-M-BD50X
	PL60X	5101-M-BD60X
	PL80X	5101-M-BD80X
	PL100X	5101-M-BD100X
10X dividing eyepiece (0.1mm/div.)		5101-M-EPD10X
Bright field objective (for 5102-M600)	PL20X	5101-M-OB20X
	PL50X	5101-M-OB50X
	PL80X	5101-M-OB80X
	PL100X	5101-M-OB100X
Digital camera		ISM-CM20, ISM-CM63, ISM-ZS70-S
Camera adapter *		5101-M-ADAPTER

* Digital camera must be used with camera adapter



PORTABLE METALLURGICAL MICROSCOPE CODE 5109-PM500

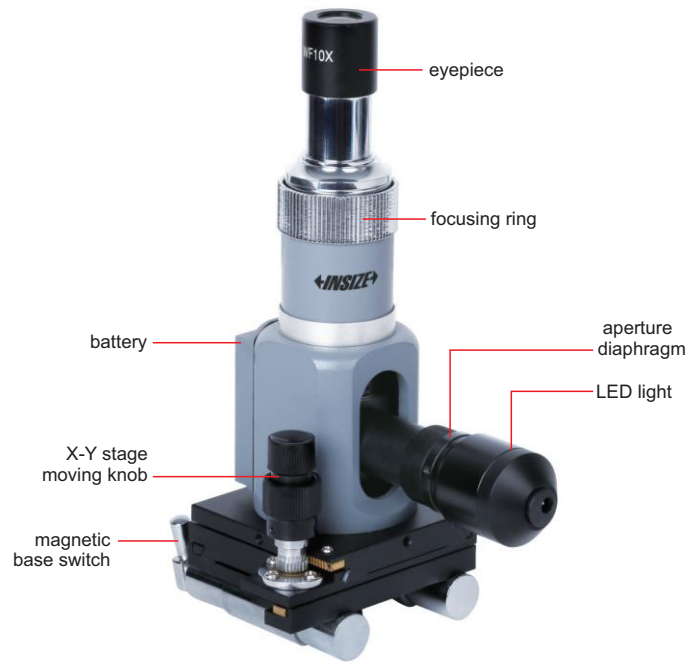
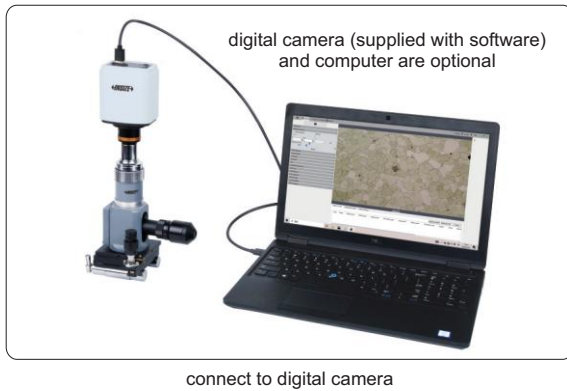

- Illumination is powered by batteries
- Aperture diaphragm improves image quality and increases depth of field
- Magnetic base with on/off switch can adhere on metal workpieces
- Can be connected to digital cameras

SPECIFICATION

Magnification	100X~500X	
Eyepiece (wide field)	10X/12.5X	
Objective (plan achromatic)	10X (included)	40X (included)
Numerical aperture	0.25	0.64
Illumination	3W LED, built-in batteries	
Stage	double layer, size: 15×12mm	
Dimension (L×W×H)	210×160×95mm	
Weight	1.5kg	

STANDARD DELIVERY

Main unit	1 pc
Eyepiece	2 pcs
Objective	2 pcs
Battery (AAA)	3 pcs

OPTIONAL ACCESSORY

Objective	5X plan achromatic	5109-PM500-OB5X
	20X plan achromatic	5109-PM500-OB20X
	100X plan achromatic	5109-PM500-OB100X
Eyepiece	5X	5109-PM500-EP5X
	15X	5109-PM500-EP15X
Digital camera*		ISM-CM20, ISM-CM63, ISM-ZS70-S
Camera adapter 0.5X		ISM-MAS-ADAPTER

*Digital camera must be used with camera adapter

INDUSTRIAL MICROSCOPES



5101-M500

- Infinite optical system, polarization observation, dark field observation
- Kohler illumination system provides uniform illumination field
- Objective 50X is spring type

SPECIFICATION

Code	5101-M500 (bright field objectives)				5101-M500BD (bright & dark field objectives)			
Illumination	6V/30W halogen lamp, brightness is adjustable				12V/50W halogen lamp, brightness is adjustable			
Objective (infinite plan achromatic)	bright field objectives				bright & dark field objectives			
	5X	10X	20X	50X	5X	10X	20X	50X
Working distance	26.1mm	20.2mm	8.80mm	3.68mm	9.70mm	9.30mm	7.23mm	2.50mm
Numerical aperture	0.12	0.25	0.40	0.70	0.12	0.25	0.40	0.70
Magnification	50X~500X							
Eyepiece (wide field)	10X (view field: Ø22mm)							
Stage	double layer							
	size: 160×140mm							
	travel: 35x30mm							
Pupil distance	53~75mm							
Diopter adjustment	±5 diopter (one eyepiece)							
Power supply	220V, 50/60Hz							
Dimension (L×W×H)	415×345×380mm							
Weight	14kg							

24

STANDARD DELIVERY

Main unit	1 pc
Anti-dust cover	1 pc

OPTIONAL ACCESSORY

Bright & dark field objective (for 5101-M500BD)	PL40X	5101-M-BD40X
	PL60X	5101-M-BD60X
	PL80X	5101-M-BD80X
	PL100X	5101-M-BD100X
10X dividing eyepiece (0.1mm/div.)		5101-M-EPD10X
Bright field objective (for 5101-M500)	PL40X	5101-M-OB40X
	PL60X	5101-M-OB60X
	PL80X	5101-M-OB80X
	PL100X	5101-M-OB100X
Digital camera		ISM-CM20, ISM-CM63, ISM-ZS70-S
Camera adapter *		5101-M-ADAPTER

* Digital camera must be used with camera adapter



INDUSTRIAL INSPECTION MICROSCOPE (LARGE STAGE) CODE 5104-M700



- For observation and inspection of large IC and chip in IT industry

SPECIFICATION

Magnification	40X~400X			
Eyepiece (wide field)	10X (view field: Ø22mm)			
Objective (plan achromatic)	4X	10X	20X	40X
Numerical aperture	0.10	0.25	0.40	0.60
Working distance	17.8mm	10mm	5.8mm	2.9mm
Stage	double layer, size: 300×268mm, travel: 250×200mm			
Kohler illumination	6V/20W halogen lamp, brightness is adjustable built-in green, blue, yellow and frosted glasses			
Pupil distance	48~75mm			
Diopter adjustment	±5 diopter (two eyepieces)			
Power supply	220V, 50/60Hz			
Dimension (L×W×H)	647×268×376mm			
Weight	12kg			

STANDARD DELIVERY

Main unit	1 pc
Camera connector	1 pc
Anti-dust cover	1 pc

OPTIONAL ACCESSORY

Bright field objective	5X plan achromatic objective (focus distance: 15.5mm)	5104-M700-OB5X
	50X plan achromatic objective (focus distance: 0.32mm)	5104-M700-OB50X
	100X plan achromatic objective (focus distance: 2mm)	5104-M700-OB100X
Polarizer and analyzer		5104-M700-AP
Digital camera		ISM-CM20, ISM-CM63, ISM-ZS70-S
Camera adapter 0.5X *		ISM-MAS-ADAPTER

*Digital camera must be used with camera adapter

ZOOM STEREO MICROSCOPE (ADVANCED TYPE) CODE 5107-S70T



LED ring light (optional)



- Greenough optical system, clear observation, real color
- High working distance is convenient for operation
- Excellent flat image and large depth of field, make observation comfortable
- 6.7:1 large zoom ratio, allow quick observation adjustment

SPECIFICATION

Optical tube	trinocular
Eyepiece (wide field)	10X (view field: Ø22mm)
Objective	0.67X~4.5X (zoom)
Observation tube	45° trinocular tube inclination angle, built-in 0.5X adapter
Zoom ratio	6.7:1
Pupil distance	50~75mm
Diopter adjustment	-8~+5 diopter (both eyepieces)
Working distance of objective	110mm
Max. workpiece height	106mm
Illumination	adjustable LED light
Power supply	110/220V, 50/60Hz
Dimension (L*W*H)	330×300×368mm
Weight	3.5kg



frosted glass filter (included)



white/black plate (included)

STANDARD DELIVERY

Main unit	1 pc
10X eyepiece	2 pcs
Ø100mm glass plate	1 pc
Ø100mm white/black plate	1 pc
Anti-dust cover	1 pc

OPTIONAL ACCESSORY

Auxiliary objective	0.5X	5107-S70T-OB05X
	1.5X	5107-S70T-OB15X
	2X	5107-S70T-OB20X
Eyepiece	15X (view field: Ø16mm)	5107-S70T-EP15X
	20X (view field: Ø12.5mm)	5107-S70T-EP20X
LED ring light		ISM-ZS-RL
Digital camera		ISM-CM20, ISM-CM63, ISM-ZS70-S

PARALLEL LIGHT PATH: REDUCE FATIGUE,
ACCESSORIES CAN BE ADDED INTO LIGHT PATH



PARALLEL LIGHT STEREO MICROSCOPE CODE ISM-ZS200

coaxial illumination (optional)



optical path splitter (optional)



iris diaphragm (optional)



- Infinity parallel optical system and 20° inclined optical tube reduce fatigue
- Coaxial illumination is optional for deep holes which cannot be observed by ring light
- Aperture diaphragm is optional for large depth of field and high quality image

SPECIFICATION

Optical tube	binocular (20° inclined)
Eyepiece (wide field)	10X (view field: Ø22mm)
Objective	0.8X~8X (zoom)
Zoom ratio	1:10
Pupil distance	55~75mm
Diopter adjustment	±5 diopter (both eyepieces)
Working distance of objective	78mm
Max. workpiece height	72mm
Illumination	adjustable reflected and transmitted LED light
Power supply	110/220V, 50/60Hz
Dimension (L×W×H)	240×280×440mm
Weight	4.3kg

STANDARD DELIVERY

Main unit	1 pc
WF10X eyepiece	2 pcs
Ø100mm glass plate	1 pc
Ø100mm white/black plate	1 pc
Anti-dust cover	1 pc

OPTIONAL ACCESSORY

Objective	0.5X achromatic objective (focus distance: 186mm)	ISM-ZS200-OB05X *
	2X plan achromatic objective (focus distance: 32.5mm)	ISM-ZS200-OB2X
	0.5X plan apochromatic objective (focus distance: 126mm)	ISM-ZS200-APO05X *
Eyepiece	WF15X (view field: Ø16mm)	ISM-ZS200-EP15X
	WF20X (view field: Ø12mm)	ISM-ZS200-EP20X
	WF30X (view field: Ø20mm)	ISM-ZS200-EP30X
Sleeve for objective		ISM-ZS200-ADAPTER
Iris diaphragm		ISM-ZS200-IRD
Optical path splitter		ISM-ZS200-OBS
Coaxial illumination		ISM-ZS200-COAXIAL
Digital camera **		ISM-CM20, ISM-CM63

* 0.5X auxiliary objective must be used with ISM-ZS200-ADAPTER

** Digital camera must be used with optical path splitter

ZOOM STEREO MICROSCOPES (ADVANCED TYPE)

LARGE ZOOM RATIO



ISM-ZS100T

connect to digital camera (for ISM-ZS100T)



LED ring light (optional)

SPECIFICATION

Code	ISM-ZS100	ISM-ZS100T
Optical tube	binocular	trinocular
Eyepiece (wide field)	10X (view field: Ø23mm)	
Objective	0.6X~5X (zoom)	
Zoom ratio	1:8.3	
Pupil distance	55~75mm	
Diopter adjustment	±5 diopter (two eyepieces)	
Working distance of objective	115mm	
Max. workpiece height	75mm	
Illumination	adjustable reflected and transmitted LED light	
Power supply	110/220V, 50/60Hz	
Dimension (L×W×H)	260×310×490mm	
Weight	4.9kg	

STANDARD DELIVERY

Main unit	1 pc
Camera connector 0.55X for ISM-ZS100T	1 pc
Digital camera adapter 1X for ISM-ZS100T	1 pc
WF10X eyepiece	2 pcs
Ø100mm glass plate	1 pc
Ø100mm white/black plate	1 pc
Anti-dust cover	1 pc

OPTIONAL ACCESSORY

Auxiliary objective	0.5X (focus distance: 220mm)	ISM-ZS100-OB05X *
	0.7X (focus distance: 125mm)	ISM-ZS100-OB07X
	2X (focus distance: 45mm)	ISM-ZS100-OB2X
Eyepiece	WF15X (view field: Ø16mm)	ISM-ZS100-EP15X
	WF20X (view field: Ø12mm)	ISM-ZS100-EP20X
	WF30X (view field: Ø8mm)	ISM-ZS100-EP30X
Sleeve for auxiliary objective		ISM-ZS200-ADAPTER
LED ring light		ISM-ZS-RL
Digital camera for ISM-ZS100T		ISM-CM20, ISM-CM63, ISM-ZS70-S

*0.5X auxiliary objective must be used with ISM-ZS200-ADAPTER

ZOOM STEREO MICROSCOPES (STANDARD TYPE)



LED ring light (optional)

ISM-ZS50

SPECIFICATION

Code	ISM-ZS50	ISM-ZS50T
Optical tube	binocular	trinocular
Eyepiece (wide field)	10X (view field: Ø22mm)	
Objective	0.8X~5X (zoom)	
Zoom ratio	1: 6.3	
Pupil distance	55~75mm (adjustable)	
Diopter adjustment	±5 diopter (two eyepieces)	
Working distance of objective	115mm	
Max. workpiece height	75mm	
Illumination	adjustable reflected and transmitted LED light	
Power supply	110/220V, 50/60Hz	
Dimension (L×W×H)	290×260×480mm	
Weight	4.9kg	

STANDARD DELIVERY

Main unit	1 pc
WF 10X eyepiece	2 pcs
Ø100mm glass plate	1 pc
Ø100mm white/black plate	1 pc
Anti-dust cover	1 pc

OPTIONAL ACCESSORY

Auxiliary objective	0.5X	ISM-ZS50-OB05X*
	2X	ISM-ZS50-OB2X
Eyepiece	10X dividing eyepiece (graduation 0.1mm/div.)	ISM-ZS50-EPD10X
	WF15X (view field: Ø16mm)	ISM-ZS50-EP15X
	WF20X (view field: Ø12mm)	ISM-ZS50-EP20X
LED ring light		ISM-ZS-RL
Sleeve for auxiliary objective		ISM-ZS200-ADAPTER
Digital camera for ISM-ZS50T		ISM-CM20, ISM-CM63, ISM-ZS70-S, ISM-KM60

*0.5X auxiliary objective must be used with ISM-ZS200-ADAPTER

ZOOM STEREO MICROSCOPES (WITH UNIVERSAL STAND)



5106-M40 (with stand type A)

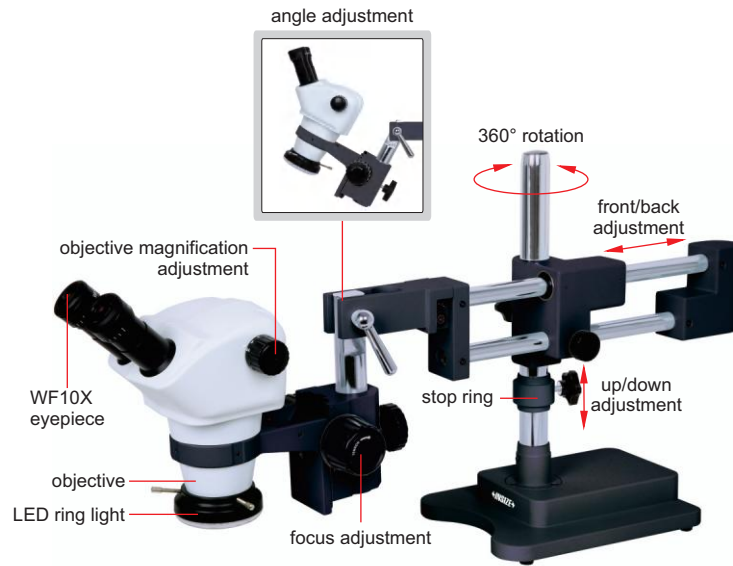

5106-M50 (with stand type B)

SPECIFICATION

Code	5106-M40	5106-M40T	5106-M50	5106-M50T
Stand	type A		type B	
Optical tube	binocular	trinocular	binocular	trinocular
Eyepiece (wide field)	10X (view field: Ø22mm)			
Objective	0.8X~5X (zoom)			
Zoom ratio	1:6.3			
Pupil distance	55~75mm			
Diopter adjustment	±5 diopter (two eyepieces)			
Working distance of objective	115mm			
Max. workpiece height	300mm			
Illumination	adjustable reflected LED ring light			
Power supply	power adapter			
Dimension (L×W×H)	610×220×430mm		790×230×430mm	
Weight	13.7kg		20kg	

STANDARD DELIVERY

Main unit (with stand)	1 pc
WF10X eyepiece	2 pcs
LED ring light	1 pc
Anti-dust cover	1 pc

OPTIONAL ACCESSORY

Auxiliary objective	0.5X	ISM-ZS50-OB05X*
	2X	ISM-ZS50-OB2X
Eyepiece	10X dividing eyepiece (0.1mm/div.)	ISM-ZS50-EPD10X
	WF15X (view field: Ø16mm)	ISM-ZS50-EP15X
	WF20X (view field: Ø12mm)	ISM-ZS50-EP20X
Adapter sleeve		ISM-ZS30-ADAPTER
0.5X adapter for 5106-M40T/M50T		ISM-MAS-ADAPTER
Digital camera for 5106-M40T/M50T**		ISM-CM20, ISM-CM63

* 0.5X auxiliary objective must be used with ISM-ZS30-ADAPTER

** Digital camera must be used with 0.5X adapter ISM-MAS-ADAPTER



ZOOM STEREO MICROSCOPE (BASIC TYPE) CODE ISM-ZS30



SPECIFICATION

Optical tube	binocular
Eyepiece (wide field)	10X (view field: Ø20mm)
Objective	1X~4.5X (zoom)
Zoom ratio	1:4.5
Pupil distance	55~75mm (adjustable)
Diopter adjustment	±5 diopter (two eyepieces)
Working distance of objective	97mm
Max. workpiece height	60mm
Illumination	adjustable reflected and transmitted LED light
Power supply	110/220V, 50/60Hz
Dimension (L×W×H)	260×190×400mm
Weight	4.3kg



LED ring light (optional)

STANDARD DELIVERY

Main unit	1 pc
WF 10X eyepiece	2 pcs
Ø95mm glass plate	1 pc
Ø95mm white/black plate	1 pc
Anti-dust cover	1 pc

OPTIONAL ACCESSORY

Auxiliary objective	0.5X	ISM-ZS30-OB05X *
	0.63X	ISM-ZS30-OB06X *
	0.75X	ISM-ZS30-OB07X *
	2X	ISM-ZS30-OB2X
Eyepiece	10X dividing eyepiece (graduation 0.1mm/div.)	ISM-ZS30-EPD10X
	WF15X (view field: Ø16mm)	ISM-ZS50-EP15X
	WF20X (view field: Ø12mm)	ISM-ZS50-EP20X
LED ring light		ISM-ZS-RL
Sleeve for auxiliary objective		ISM-ZS30-ADAPTER
Digital camera		ISM-CM63
Camera adapter 0.75X **		ISM-AD-0D75

*0.5X, 0.63X and 0.75X auxiliary objectives must be used with ISM-ZS30-ADAPTER

** Digital camera must be used with camera adapter 0.75X

LONG WORKING DISTANCE STEREO MICROSCOPES (LOW MAGNIFICATION)



5305-ZS80



5305-ZS90

SPECIFICATION

Code	5305-ZS80 (with metal base)	5305-ZS90 (with magnetic base)
Magnification	8X	
Eyepiece (wide field)	10X (view field: Ø20mm)	
Objective	0.8X	
Pupil distance	55~75mm	
Diopter adjustment	±5 diopter (one eyepiece)	
Working distance of objective	115mm	
Max. workpiece height	100mm	140mm
Dimension (L×W×H)	280x160x370mm	280x180x410mm
Weight	3.7kg	2.1kg

STANDARD DELIVERY

Main unit	1 pc
10X eyepieces	1 pair
0.8X objective	1 pc
Anti-dust cover	1 pc

LED ring light (optional)



OPTIONAL ACCESSORY

Eyepiece	WF5X (view field: Ø20mm)	5305-ZS80-EP5X
	WF15X (view field: Ø15mm)	5305-ZS80-EP15X
	WF20X (view field: Ø10mm)	5305-ZS80-EP20X
LED ring light	ISM-ZS-RL	



POLARIZING MICROSCOPE CODE ISM-POL1000



- Widely used in geology, mineralogy, fossil fuel exploration
- Single polarization, orthogonal polarization or conoscopic observation are available

SPECIFICATION

Magnification	40X~600X				
Eyepiece	10X (view field: \varnothing 20mm)				
Infinite strain free plan achromatic objective	4X (transmitted/reflected)	10X (transmitted/reflected)	20X (transmitted)	40X (transmitted)	60X (transmitted)
Working distance	22.2mm	6.1mm	6.4mm	0.6mm	0.3mm
Numerical aperture	0.1	0.25	0.4	0.65	0.8
Stage	revolving round stage diameter: \varnothing 160mm graduation: 1°, resolution: 6'				
Pupil distance	53~75mm				
Diopter adjustment	\pm 5 diopter (one eyepiece)				
Illumination	12V/50W halogen lamp, brightness is adjustable (reflected illumination) 12V/20W halogen lamp, brightness is adjustable (transmitted illumination)				
Power supply	110/220V, 50/60Hz				
Dimension (L×W×H)	614×250×394mm				
Weight	13kg				

STANDARD DELIVERY

Main unit	1 pc
Micrometer	1 pc
Grid plate	1 pc
10X crossing eyepiece (view field: \varnothing20mm)	1 pc
10X dividing eyepiece (view field: \varnothing20mm, graduation 0.1mm)	1 pc
λ slip (first class red) and 1/4λ slip	1 pc
Quartz wedge	1 pc

OPTIONAL ACCESSORY

Objective for reflected system	PL20X	ISM-POL1000-OBR20X
	PL40X	ISM-POL1000-OBR40X
	PL60X	ISM-POL1000-OBR60X
	PL100X	ISM-POL1000-OBR100X
Objective for transmitted system	PL100X	ISM-POL1000-OBT100X
Specimen presser		ISM-POL1000-SP

3D LARGE DEPTH OF FIELD CAMERA CODE ISM-DF80

ROTATABLE
OBSERVATION

STEREOSCOPIC 3D IMAGING
AND MEASUREMENT

AUTO
FOCUS



mounted on microscope

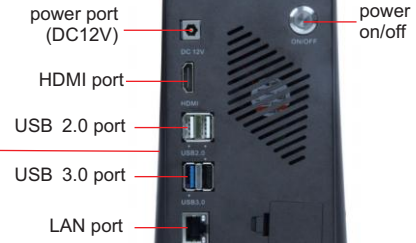

C-mount port

- Built-in measuring software for display, without computer
- 2D observation and measurement, auto focus
- Focus stacking for large depth of field observation
- Constructing 3D imaging and 3D measurement
- Creating report automatic and data can be exported
- Real-time wide dynamic, effectively eliminating reflections on metal surfaces

SOFTWARE

capture image calibration 2D auto 3D report chromatogram height height difference measurement
processing measurement measurement measurement

Smart software

3D Measure

3D Display 3D Histogram

3D Profile 3D Surface

Height Curvature Area

Profile Selection

x1: 0.00 μm x2: 351.68 μm
y1: 0.00 μm y2: 197.82 μm
Distance: 402.49 μm

Report

2D Image, 3D Image
 3D-Profile
 3D-Surface
Create Report

File Save

File Name: HeightData + yyyy-MM-dd-hh-mm-ss
File Path: /home/ividia/Desktop/Imager/3D
 3D Height Data
Save
Open 3D Image

Measure Tool

Width: 402.995μm Height: 3.680μm

Height(μm)

μm

Height Data	HeightMeasure Data						
	X1	Y1	X2	Y2	Distance	HeightDiff	
1	0.00μm	0.00μm	351.31μm	197.45μm	402.995μm	3.680μm	Save

Continued from previous page

3D COMPOSITE IMAGE

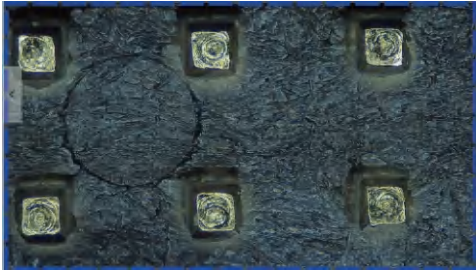

depth of field synthesized image

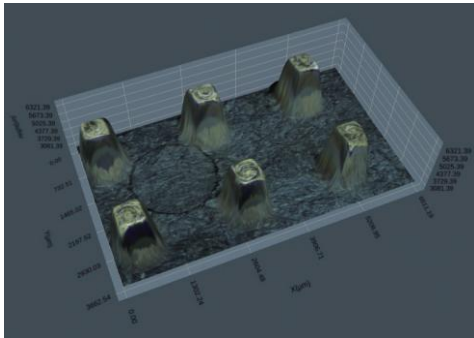

3D composite image

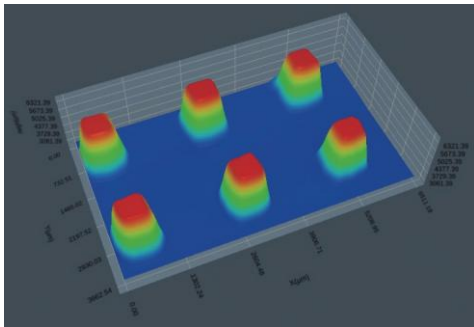

chromatogram height image

3D MEASUREMENT APPLICATION

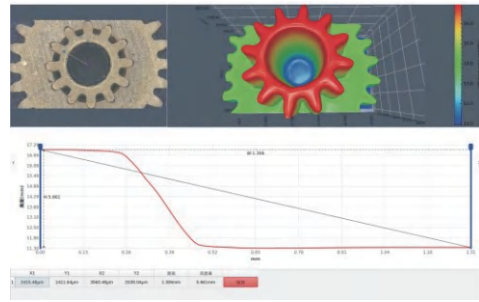

measurement of component bore height

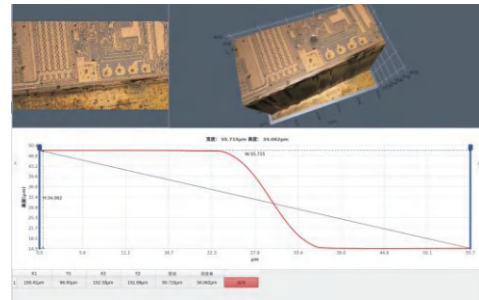

measurement of height difference of metal parts

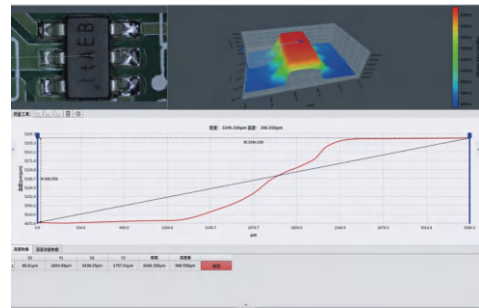

measurement of board height differences

SPECIFICATION

Sensor	1/2" CMOS
Resolution	1920×1080
Pixel	2M
Single pixel	3.75×3.75μm
Frame rate	60fps (normal) / 30fps (WDR)
Output	HDMI/LAN
Lens connection	C-mount
Exposure	auto: 0.1~16.6ms, manual: 0.0001~1s
Power supply	110~220V, 50/60Hz
Dimension (L×W×H)	87×181×103mm
Weight	2500g

STANDARD DELIVERY

Camera	1 pc
16G USB flash disk	1 pc
Mouse	1 pc
Keyboard	1 pc
HDMI 2.0 cable	1 pc
Glass calibration ruler	1 pc
Calibration block	1 set
Power adapter	1 pc

DIGITAL CAMERA FOR MICROSCOPES (WITH PAD) CODE ISM-ZS70-S

ATTENTION: CAMERA CONNECTOR AND ADAPTER ARE NEEDED ACCORDING TO MICROSCOPES

MEASUREMENT, TAKE PICTURES AND VIDEOS

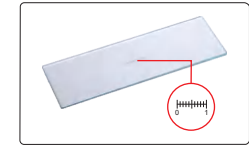

glass calibration ruler (included, graduation 0.1mm)

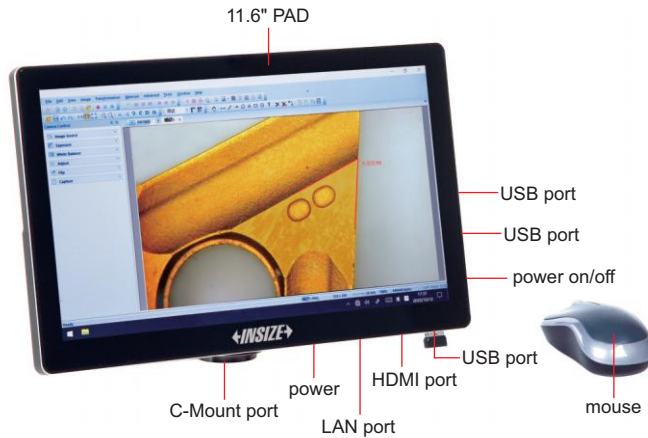

- Windows 10 operation system
- Built-in software, can take pictures and videos, can measure
- Language: Chinese, English, French, Japanese, German, Polish, Arabic
- Automatic exposure, white balance, brightness, contrast ratio, saturation are adjustable
- Image process feature: zoom in/out, flip, mirror, stitching and so on
- Output to Excel or CSV file

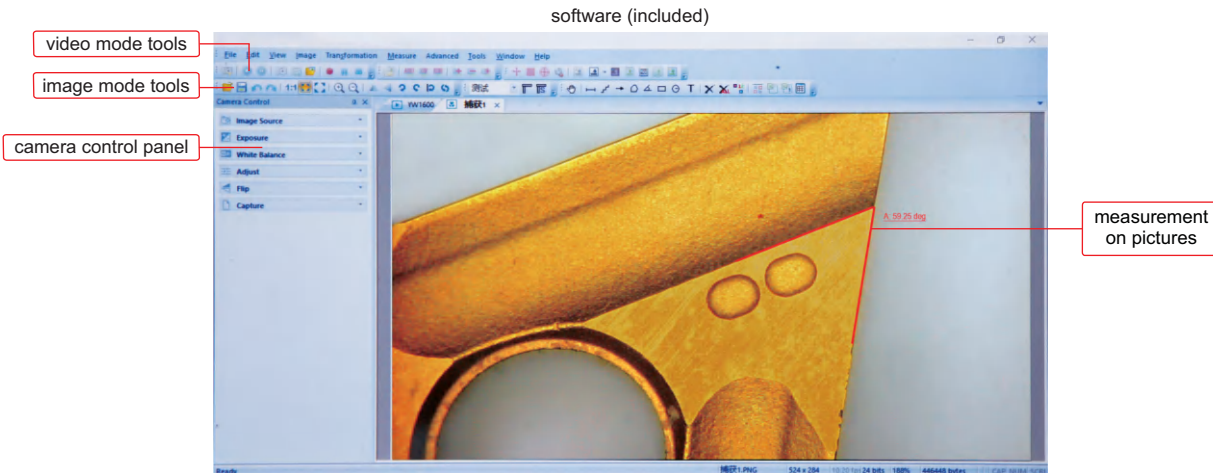

Measuring tools



measure line



measure meander line



arrow mark



measure polygon



calibration



measure angle



measure rectangle



measure circle



text mark



show/hide scale

SPECIFICATION

Sensor	1/2.3" CMOS
Pixel	16M
Resolution	800×600, 1600×1200, 1920×1080, 2048×1536, 2304×1728, 2592×1944, 4608×3456
Frame rate	30fps (1920×1080)
Output	HDMI, USB 3.0
Power supply	power adapter
Dimension (L×W×H)	280.3×177.4×12.5mm
Weight	0.9kg

STANDARD DELIVERY

Main unit	1 pc
Mouse	1 pc
Glass calibration ruler (graduation 0.1mm)	1 pc
AC/DC adapter	1 pc



ATTENTION: ADAPTERS ARE NEEDED ACCORDING TO MICROSCOPES

DIGITAL CAMERA FOR MICROSCOPES CODE ISM-CM63

- To be used with computers
- Sony Exmor back-illuminated CMOS sensor
- USB3.0 transmission
- Automatic exposure, gain adjustment, white balance, chrominance adjustment, saturation adjustment, gamma correction, luminance adjustment, contrast adjustment



C-mount port

adapter 0.75X (optional)



application



glass calibration ruler (included, graduation 0.1mm)

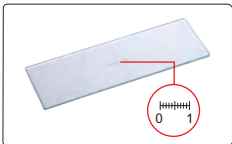

automatic image stitching (expand field of view)

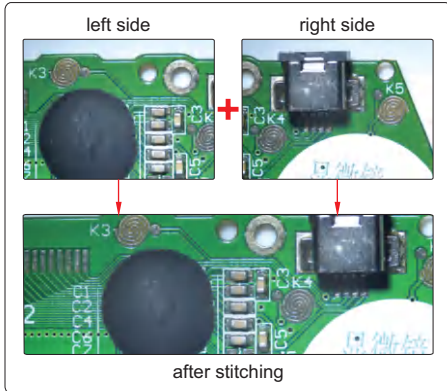

counting

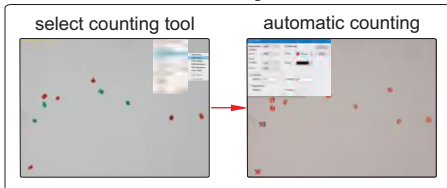

software (included)

selectable resolution

histogram (quantify the distribution of color and brightness)

black balance (reduce color difference)

measurement items

flat field correction (reduce brightness difference)

real time gray calibration

dark field correction (reduce thermal noise)

The software can control image completely, including measurement, image stitching, extend focus depth, image gray processing, RGB histogram observation, image color sampling, 3D plot (3D representation of image intensity), image exposure, white balance, black balance, image bit depth, flat field correction and dark field correction, etc.

focus stacking



Measuring tools:

- | | |
|---|--|
| measure length of line or distance between two points | measure rectangle |
| measure distance between two parallel lines | measure width and diameter of ring |
| measure angle | measure diameter, length, perimeter angle of arc |
| measure radius, girth and area of circle | measure area of polygon |
| measure axis lengths, girth and area of ellipse | measure center distance between two circles |
| calibration | measure length of open curve |

binary

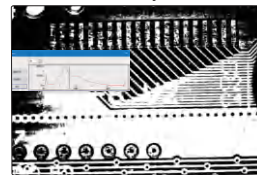

separate target and background

3D plot

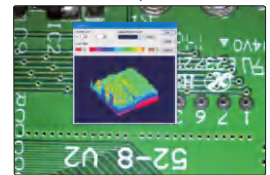

visualize the distribution of image brightness and color

To be continued

Continued from previous page

SPECIFICATION

Sensor (back-up)	1/1.8" CMOS
Resolution	3072×2048
Pixel	6.3M
Single pixel size	2.4×2.4μm
Spectral range	380-650nm (with infrared cut filter)
Frame rate	30fps
Sampling average	1×1
Exposure time	0.1ms~15s
Power supply	USB port
Weight	400g

COMPUTER REQUIREMENT

Operation system	Windows 7/8/10
CPU	Intel Core 2 2.8Hz or above
Memory	2GB or above
USB port	USB3.0 (recommand) or USB2.0
Display	17" or above

STANDAER DELIVERY

Camera (USB cable included)	1 pc
Software	1 pc
Glass calibration ruler (graduation 0.1mm)	1 pc

OPTIONAL ACCESSORY

Adapter 0.75X	ISM-AD-0D75
---------------	-------------

DIGITAL CAMERA FOR MICROSCOPES CODE ISM-KM60

FOCUS
STACKING

AUTOMATIC IMAGE
STITCHING

ATTENTION: ADAPTERS ARE NEEDED
ACCORDING TO MICROSCOPES



adapter 0.75X
(optional)



C-mount port

application



glass calibration ruler
(included, graduation 0.1mm)

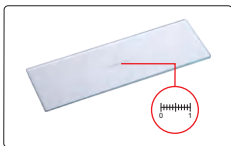

PROFESSIONAL MEASURING SOFTWARE (INCLUDED, FOR COMPUTERS)

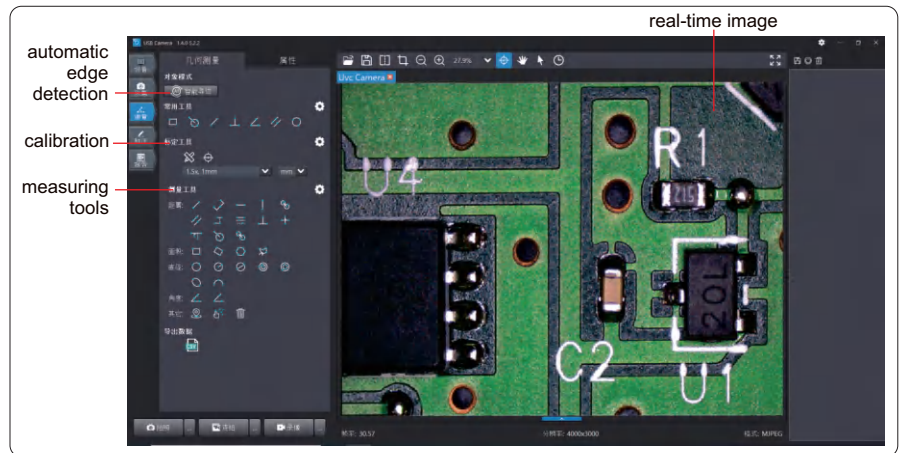

- To be used with computers
- Sony Exmor back-illuminated CMOS sensor
- USB3.0 transmission
- Measuring software for computers is included
- For bright field, dark field or fluorescent field
- Automatic exposure, gain adjustment, white balance, chrominance adjustment, saturation adjustment, gamma correction, luminance adjustment, contrast adjustment

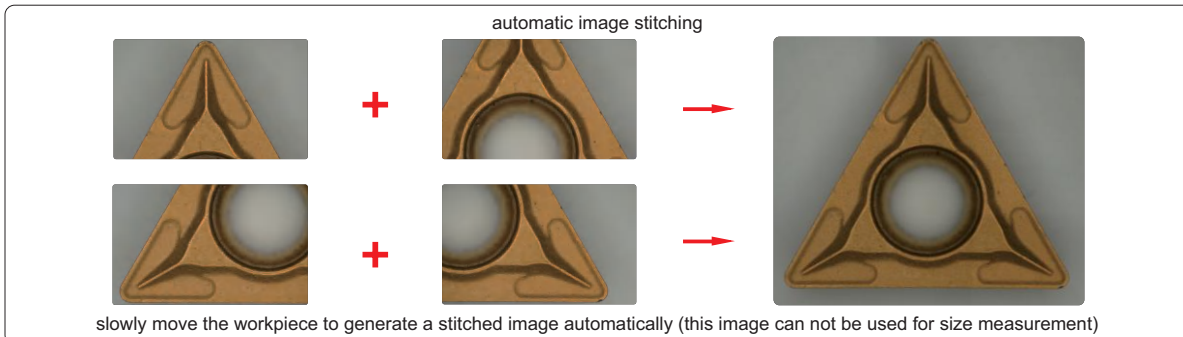

To be continued

Continued from previous page

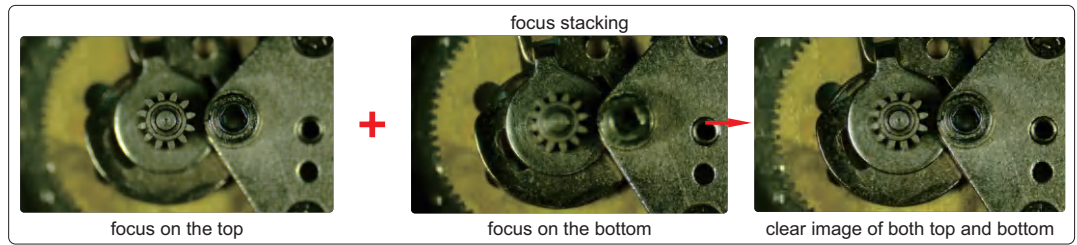

SPECIFICATION

Sensor (back-up)	1/1.8" CMOS
Resolution	3072×2048
Pixel	6M
Single pixel size	2.4×2.4μm
Frame rate	30fps
Lens connection	C-mount
Output	USB 3.0
Environmental requirement	temperature: -20°C~70°C
Weight	275g

OPTIONAL ACCESSORY

Adapter 0.75X	ISM-AD-0D75
---------------	-------------

COMPUTER REQUIREMENT

Operation system	Windows 10 or above
CPU	Intel Core i5 7th gen or above
Memory	8GB or above
USB port	USB3.0

STANDAER DELIVERY

Camera (USB cable included)	1 pc
Software	1 pc
Glass calibration ruler (graduation 0.1mm)	1 pc



SMART CAMERA CODE ISM-MV10



- Built-in software, operated by mouse.
- Automatically calculate, store the test results and sent to Excel
- Camera with PLC control input and output interface, can be integrated with automation equipment
- Functions: presence or absence of objects, position tilt correction, object counting, color detection, stain detection, dimension measurement, position guide, etc.

SPECIFICATION

Chip structure	FPGA+ARM
Operation system	Linux 3.10
Kernel structure	dual-core Cortex-A9
Frequency	1GHZ
I/O port	3 sets of input and output (can be connected to photoelectric switch, wire switch, PLC, etc.)
Operation temperature	-10~70°C
Sensor	1/2" CMOS
Single pixel size	3.75×3.75μm
Resolution	1920×1080
Frame rate	60fps
Video output	HDMI port
Lens connection	standard C port

SOFTWARE

presence or absence of objects

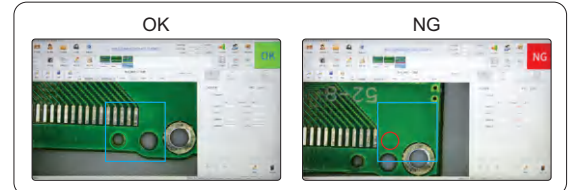

select the area and specify the target, the camera will automatically detect the presence or absence of the target.

automatic counting



select the area and specify the target, the camera will automatically calculate the number of targets.

dimension measurement

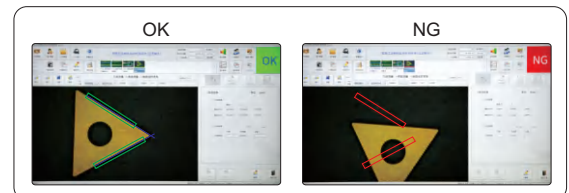

measuring angle, distance, radius, center distance, etc.

STANDAER DELIVERY

Camera (with HDMI cable)	1 pc
Software	1 pc

DIGITAL CAMERA FOR MICROSCOPES CODE ISM-CM20

ATTENTION: ADAPTERS ARE NEEDED ACCORDING TO MICROSCOPES

FOCUS STACKING

AUTOMATIC IMAGE STITCHING

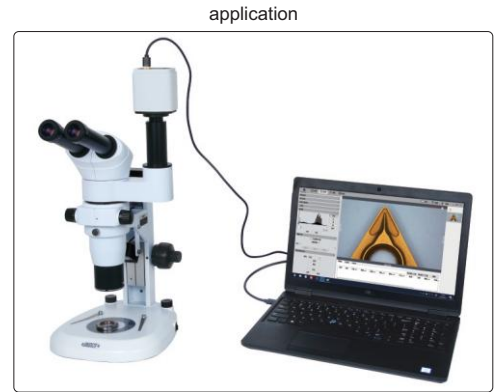
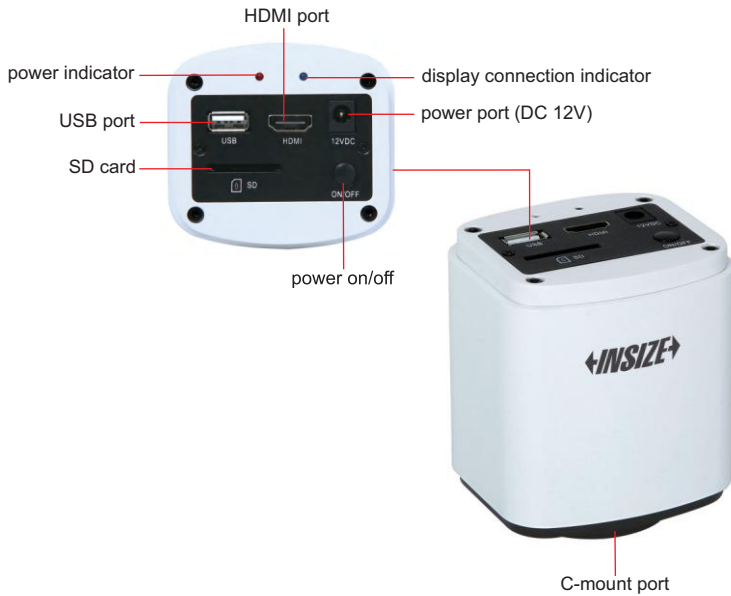

- 1080P high-definition image
- Can be connected with displays or computers
- Built-in simple measuring software for displays, without computer
- Professional measuring software for computers is included
- For bright field, dark field or fluorescent field
- Automatic exposure, white balance, gain adjustment, gamma correction, brightness contrast adjustment, saturation adjustment, chroma sharpness adjustment
- Focus stacking, automatic image stitching

adapter 0.5X (optional)

glass calibration ruler (included, graduation 0.1mm)

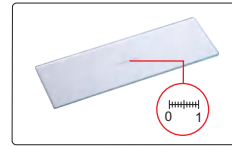

SIMPLE MEASURING SOFTWARE (BUILT-IN, FOR DISPLAYS)

Measuring tools:

- measure length of line or distance between two points
- measure distance between point and line
- measure rectangle
- measure concentric circles
- measure circle
- measure curve
- measure polygon
- measure center distance of two circles
- measure angle of two lines



auto exposure, white balance, gain adjustment, gamma, chroma contrast adjustment, brightness sharpness adjustment, size measurement

To be continued

Continued from previous page

PROFESSIONAL MEASURING SOFTWARE (INCLUDED, FOR COMPUTERS)

selectable resolution

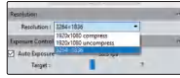

white balance
(balance color based on actual light source)

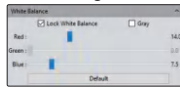

histogram
(quantify the distribution of color and brightness)

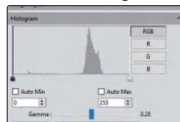

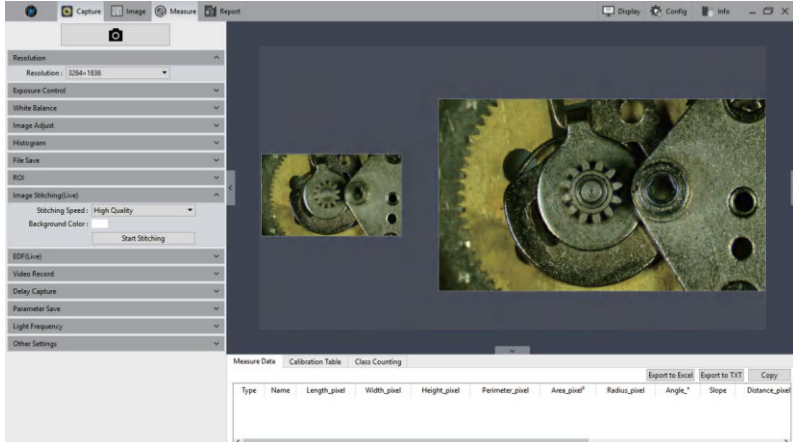
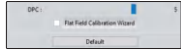
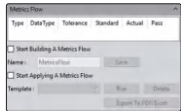

image coloring, fluorescence synthesis, binary, image smoothing, color filter/color extraction/color inversion, delay capture, focus stacking, automatic image stitching, metrics flow, manual counting, dynamic and static measurement, layered measurement, report generation and printing, delay record, flat field correction, image adjustment, histogram.

flat field correction





metrics flow
(create templates, set tolerances and build metrics flow)

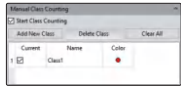

manual counting
(class counting)



focus stacking





+

→





focus on the top

focus on the bottom

clear image of both top and bottom

automatic image stitching

+

→



+

→

slowly move the workpiece to generate a stitched image automatically (this image can not be used for size measurement)

SPECIFICATION

Sensor	1/2.8" CMOS
Pixel	2M
Resolution	1920×1080
Frame rate	30fps
Power supply	power adapter
Output	HDMI/USB
Lens connection	C-mount

COMPUTER (optional) REQUIREMENT

Operation system	Windows 7/8/10 (64 bit)
CPU	Intel Core i5 or above
Memory	8GB or above
USB port	USB 3.0

DISPLAY (optional) REQUIREMENT

Size	13" or above
Resolution	1080P or above
HDMI port	type A

STANDARD DELIVERY

Main unit	1 pc
16G memory card and holder	1 pc
Glass calibration ruler (graduation 0.1mm)	1 pc
Mouse	1 pc
HDMI cable	1 pc
USB cable	1 pc
Power supply	1 pc

OPTIONAL ACCESSORY

Adapter 0.5X	ISM-MAS-ADAPTER
--------------	-----------------

WIFI 4K CAMERA FOR MICROSCOPES CODE ISM-MP8B

WIRELESS AD-HOC NETWORK

AUTOMATIC IMAGE STITCHING

FOCUS STACKING

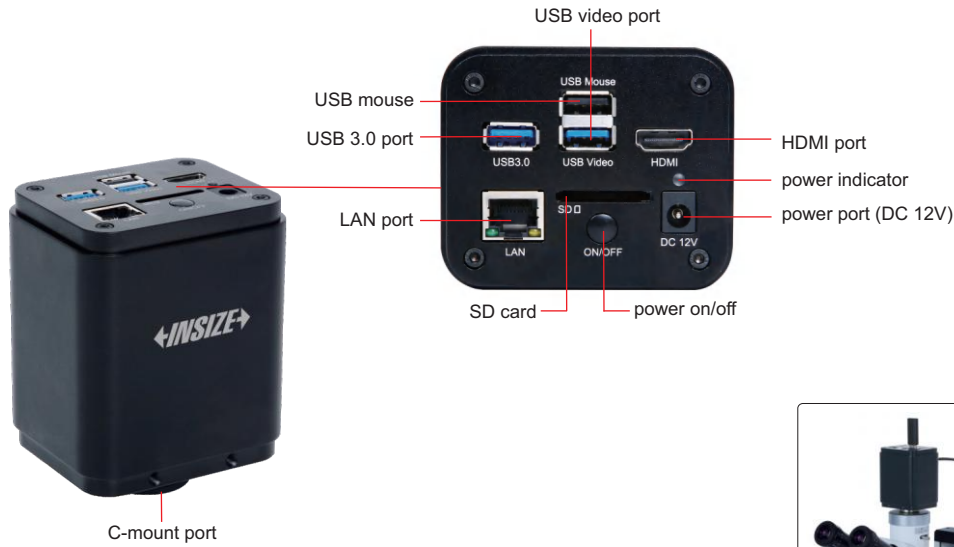

- 4K high-definition image
- Can be connected with displays or computers
- Built-in simple measuring software for display, without computer
- Professional measuring software for computers is included
- 4K HDMI/LAN/USB multiple video outputs
- 4K/1080P automatically switched by display resolution
- Focus stacking, automatic image stitching
- Wireless network or wired network

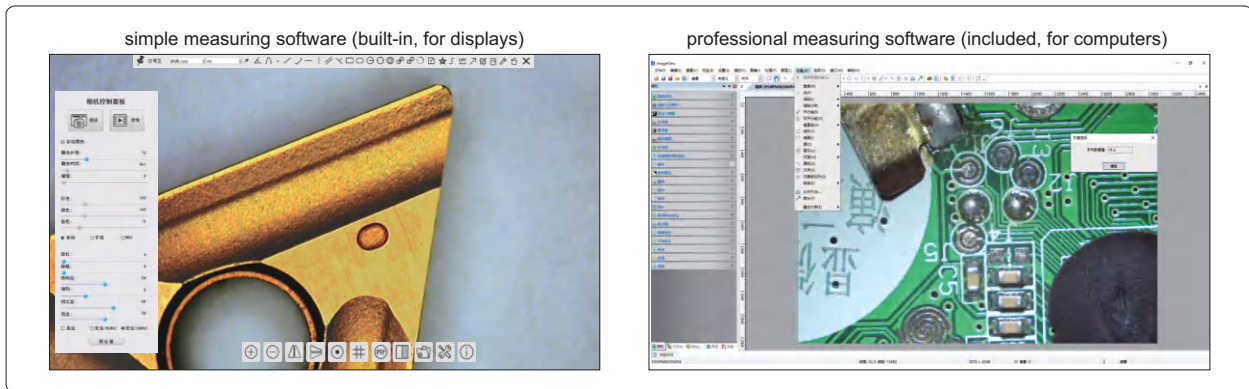
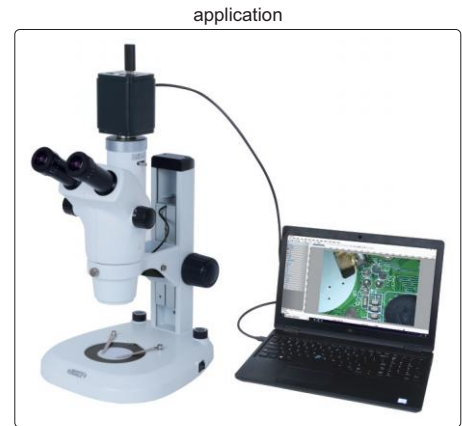

SPECIFICATION

Sensor	1/1.2" CMOS
Pixel	8M
Resolution	3840×2160, 1920×1080
Single pixel	2.9×2.9µm
Frame rate	60fps@3840×2160 (HDMI) 30fps@3840×2160 (LAN) 30fps@3840×2160 (USB)
Binning	1×1
Exposure	0.04~1000ms
Output	HDMI/USB/LAN
Lens connection	C-mount
Power supply	DC 12V 1A
Dimension (L×W×H)	80×65×105mm
Weight	700g

CONNECTION

HDMI	comply with HDMI 2.0 standard 4K/1080P automatically switched by display resolution
LAN	H264 encoded video bandwidth adjustment in real time DHCP configuration or manual configuration unicast/multicast configuration
WLAN	connecting 5G WLAN adapter (USB 3.0 interface) in AP/STA mode
COMPUTER	connecting USB video port of PC for video transmission H264/MJPEG format video

To be continued

Continued from previous page

STANDARD DELIVERY

Main unit	1 pc
32G SD card	1 pc
USB mouse	1 pc
HDMI2.0 cable	1 pc
USB3.0 cable	1 pc
USB wlan adapter	1 pc
Wlan cable	1 pc
Glass calibration ruler	1 pc
Calibration plate	1 pc
Software	1 pc
Power adapter	1 pc

OPTIONAL ACCESSORY

16G USB flash disk	IS-USBDISK-16G	
Adjustable lens adapter	Ø23.2mm eyepiece tube	ISM-MP-2A075
	Ø31.75mm eyepiece tube	ISM-MP-3A075
Fixed lens adapter	Ø23.2mm eyepiece tube	ISM-MP-2F075
	Ø31.75mm eyepiece tube	ISM-MP-3F075
Adapter ring for Ø30.0mm eyepiece tube	ISM-MP-300R	
Adapter ring for Ø30.5mm eyepiece tube	ISM-MP-305R	

COMPUTER

Operation system	Windows 7/8/10/11
CPU	Intel Core 2 2.8Hz
Memory	2GB
USB port	USB 3.0 or USB 2.0 port
Display	17"

PROFESSIONAL MEASURING SOFTWARE (INCLUDED, FOR COMPUTERS)

Measuring tools:

- measure length of line or distance between two points
- measure rectangle
- measure distance between two parallel lines
- measure width and diameter of ring
- measure angle
- measure diameter, length, perimeter angle of arc
- measure radius, girth and area of circle
- measure area of polygon
- measure axis lengths, girth and area of ellipse
- measure center distance between two circles
- calibration
- measure length of open curve

automatic image stitching (expand field of view)

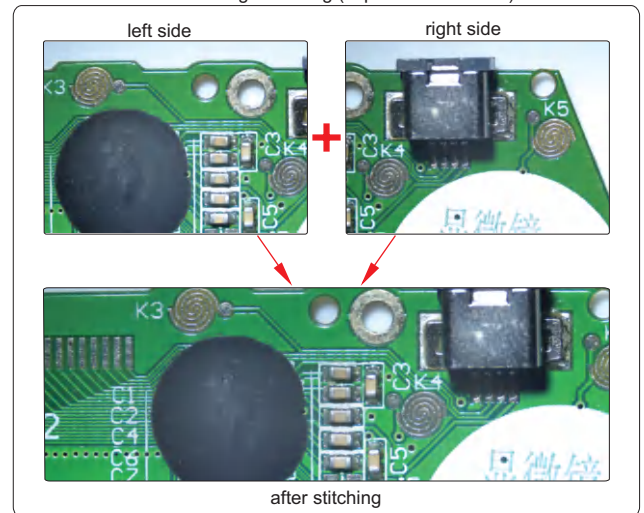

focus stacking



3D plot



visualize the distribution of image brightness and color

counting

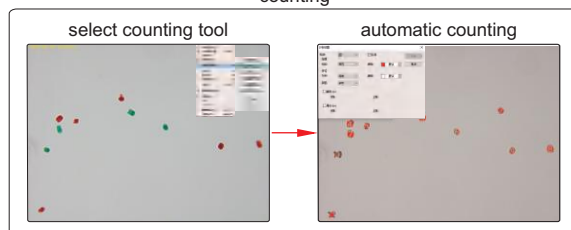

binary

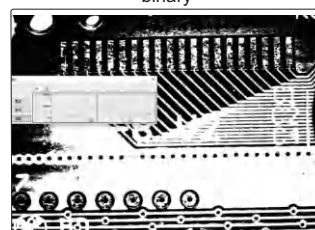

separate target and background

METALLURGICAL ANALYSIS SOFTWARE AND CAMERA CODE ISM-MAS100



- More than 100 standards (ISO, ASTM, JIS, etc.)
- For metallurgical microscopes
- The camera can be inserted into the eyepiece tube or camera connector of microscopes
- Metallurgical analysis software is included, which can make comparative analysis, measurement and evaluation of various materials



application



software flash disk (included)



glass calibration ruler (included)

metallurgical analysis software (included)

tool bar

gallery

this software can be used with variety of metallographic microscopes for acquisition, processing, analysis, report generation of metallurgical images

metallurgical module list

Select autoAnalysis Item

- [001] METHOD OF AVERAGE GRAIN SIZE, AREA OF METAL
- [003] METHOD OF AVERAGE GRAIN SIZE, AREA OF METAL
- [002] METAL AVERAGE GRAIN SIZE CUTTING POINT METHOD
- [004] Details of Average Grain Size Testing for Other Metals and Alloys
- [005] Standard for Dual Grain Size Characterization Test Method Area Fraction Evaluation Comparison Chart
- [006] Standard for Dual Grain Size Characterization Test Method_M1. Micrographs of Dual Grain Size Types
- [007] Standard for Dual Grain Size Characterization Test Method_M1. Micrographs of Dual Grain Size Types
- [008] Standard for Dual Grain Size Characterization Test Method_M2. Application of Statistical Program For Determining Grain Size Distribution
- [009] steel apparent grain size of micrographic estimating(automatic) EN
- [010] steel apparent grain size of micrographic estimating(transversal) Method EN
- [011] Determination of nonmetallic inclusion content in steel by standard grading diagram
- [012] Evaluation Method of Inclusion Content in Steel_method (burst field of view method)
- [013] Evaluation Method of Inclusion Content in Steel_method (Low Inclusion Content Method)
- [014] Evaluation Method of Inclusion Content in Steel_method
- [015] Metallurgical examination method. Microscopic examination of non-metallic inclusions in high quality steel by metallographic diagram
- [016] Metallurgical examination of precious metal cuprous oxide
- [017] Determination of decarburization depth of steel
- [018] DETERMINATION OF FERRITIC GRAIN SIZE OF LOW CARBON STEEL COIL ROLLED SHEET GRAIN Elongation
- [019] Determination of Phase Area Content of Stainless Steel
- [020] Metallurgical Examination of Gray Cast Iron Graphite Distribution Shape
- [021] Metallurgical Examination of Gray Cast Iron Graphite Length (Manual Analysis)
- [022] Metallurgical Examination of Gray Cast Iron Graphite Length (Automatic Analysis)
- [023] Metallurgical Examination of Gray Cast Iron Number of Pearlitic
- [024] Metallurgical Examination of Gray Cast Iron Number of Carbides
- [025] Metallurgical Examination of Gray Cast Iron Number of Phosphorus Eutectic
- [026] Metallurgical Examination of Gray Cast Iron Determination of the Number of Eutectic Groups of Cast Iron
- [027] Metallurgical examination of gray cast iron Phosphorus eutectic type etc
- [028] Quantitative metallographic determination
- [029] Iron cementite
- [030] Pearlite in Low Carbon Deformed Steel
- [031] Dental tissue
- [032] Microanalytical EIS
- [033] Microstructure Assessment of Steel Calculation of Ferrite Content
- [034] Metallurgical Hardtenite Needle Length Rating of Carburized Gear For Automobile
- [035] Metallurgical Carbide Rating of Carburized Gears For Automobile
- [036] Metallurgical Retained Austenite Rating of Carburized Gears for Automobile

Multi-module grad

OK Cancel

To be continued

Continued from previous page

examples of metallurgical analysis

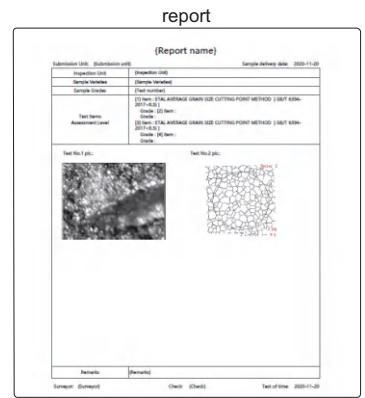
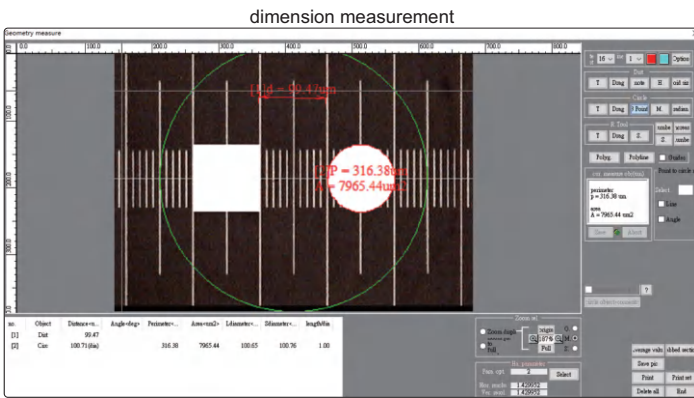
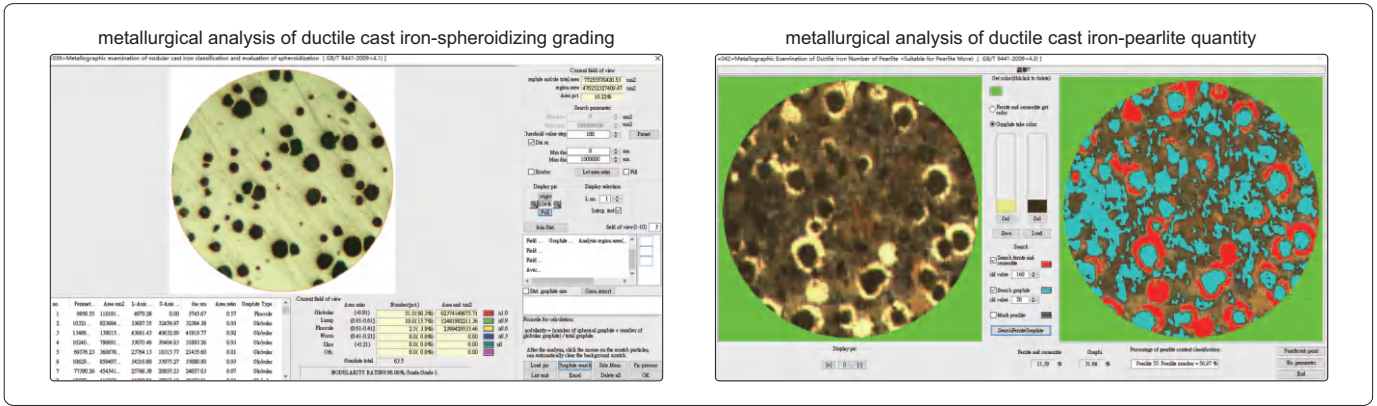

focus stacking

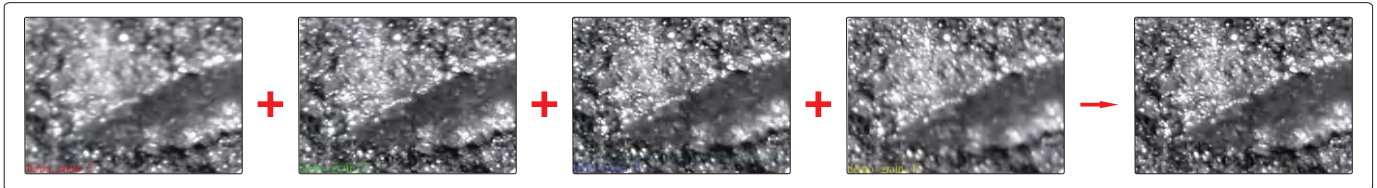
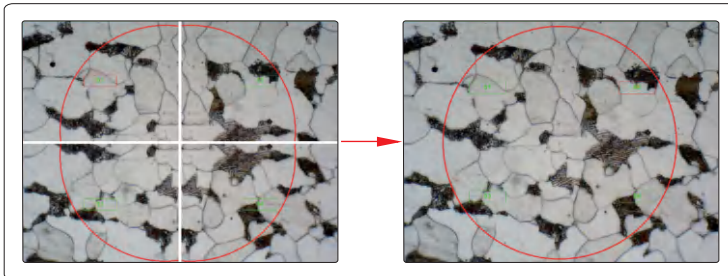
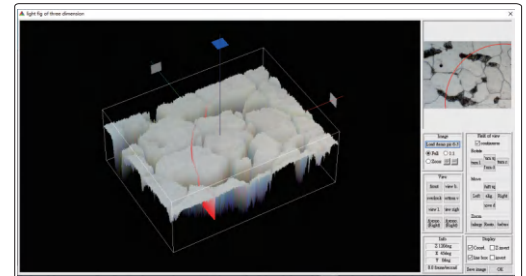

image stitch



three dimension map



SPECIFICATION

Sensor	1/1.8" CMOS
Pixel	6.3M
Resolution	3072×2048
Frame rate	30fps
Exposure time	0.1ms~15s
Power supply	USB port
Weight	400g

STANDARD DELIVERY

Camera (USB cable included)	1 pc
Software	1 pc
Glass calibration ruler	1 pc

CAMERA ADAPTERS

- Ø23.2/30mm eyepiece adapter is included
- Suitable for digital cameras ISM-CM20, ISM-CM63, ISM-ZS70-S, ISM-KM60



Ø23.2/30mm eyepiece adapter (included)



0.5X camera adapter (fixed focus distance) ISM-AD-0D5



0.75X camera adapter (fixed focus distance) ISM-AD-0D75



0.5X camera adapter (adjustable focus distance) ISM-AD-A0D5



0.75X camera adapter (adjustable focus distance) ISM-AD-A0D75



SPECIFICATION

Code	ISM-AD-0D5	ISM-AD-A0D5 *	ISM-AD-0D75	ISM-AD-A0D75
Type	fixed focus distance	adjustable focus distance	fixed focus distance	adjustable focus distance
Magnification	0.5X	0.41X~0.58X	0.75X	0.64X~0.86X

* There may be shadows on the edge of image when ISM-AD-A0D5 is used

PORTABLE MEASURING MICROSCOPES



ISM-PM100

SPECIFICATION

Code	ISM-PM20	ISM-PM40	ISM-PM50	ISM-PM100
Total magnification	20X	40X	50X	100X
Eyepiece	10X with graduation	10X with graduation	10X with graduation	10X with graduation
Objective (achromatic)	2X (numerical aperture: 0.05)	4X (numerical aperture: 0.1)	5X (numerical aperture: 0.12)	10X (numerical aperture: 0.25)
Working distance	17.2mm	18mm	17.6mm	7mm
Graduation	0.05mm	0.025mm	0.02mm	0.01mm
Viewing field	Ø9mm	Ø4.5mm	Ø3.6mm	Ø1.8mm
Focus range	30mm			
Illumination	LED light			
Diameter of base	Ø63mm			
Height	210mm			
Weight	650g			

STANDARD DELIVERY

Main unit	1 pc
Pen light	1 pc
Battery (AAA)	2 pcs

**TABLE MAGNIFIER WITH ILLUMINATION
CODE 7517-3D**

- Four steps brightness adjustment
- LED illumination, working life 20000h
- Resin lens

SPECIFICATION

Magnification	1.75X
Diopter	3D
Lens diameter	Ø125mm
Illumination	power: 3W, illumination: 260lm
Power supply	power adapter 12V, 1A



TABLE MAGNIFIERS WITH ILLUMINATION

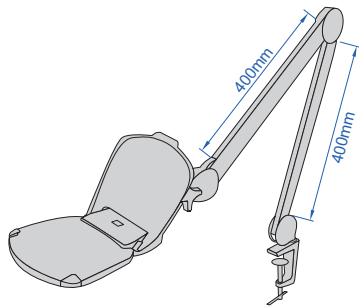

- LED illumination, working life 20000h
- Resin lens

SPECIFICATION

Code	7520-320D	7521-3D
Magnification	two magnifications 1.75X/6X	1.75X
Diopter	3D/20D	3D
Lens dimension	160×127mm	Ø126mm
Illumination	power: 6W, illumination: 550lm	
Power supply	power adapter 12V, 1A	



**TABLE MAGNIFIER WITH ILLUMINATION
CODE 7516-5D**

- LED illumination, working life 20000h

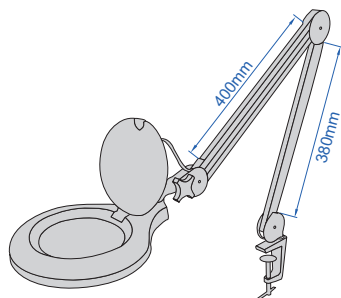

SPECIFICATION

Magnification	2.25X
Diopter	5D
Lens diameter	Ø122mm
Illumination	power: 7W, illumination: 420lm
Power supply	100~240V, 50~60Hz



DIGITAL MAGNIFIER CODE 7525-D4

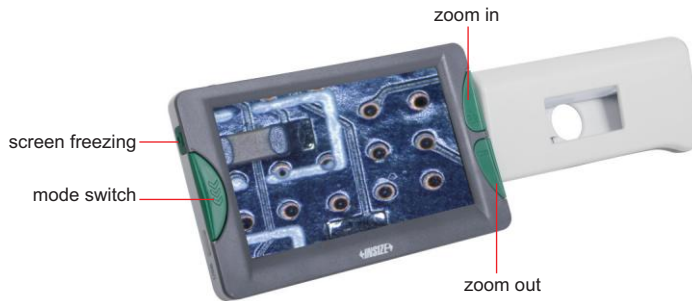

- 720P60 camera
- Auto focus
- With screen freezing function
- 26 color modes can be switched to meet the needs of different people
- Port to TV
- Automatic shutdown after 3 minutes

after the handle is folded, the magnifier can be directly placed on the object for observation



SPECIFICATION

Screen size	4.3 inch
Screen resolution	480×272
Magnification	2X-32X
Pixel	8M
Focus	manual/automatic
Color mode (26 modes)	color mode, color enhancement mode, negative mode, monochrome mode, black on white, white on black, blue on white, white on blue, yellow on black, black on yellow, yellow on blue, blue on yellow, green on white, white on green, orange on white, white on orange, red on black, black on red, orange on black, black on orange, yellow on green, green on yellow, red on white, white on red, yellow on white, white on yellow
Output	TV
Charging port	Type-C
Lithium battery	1600mAH (for 4 hours working)
Dimension (LxWxH)	123×39×76mm (when the handle is folded)
Weight	210g

STANDARD DELIVERY

Main unit	1 pc
Video output cable	1 pc
USB charging cable	1 pc
Power adapter	1 pc

side and back

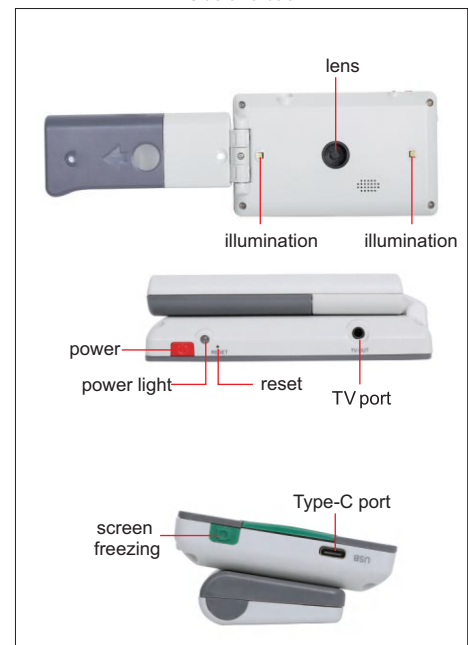



DIGITAL MAGNIFIER CODE 7526-D5

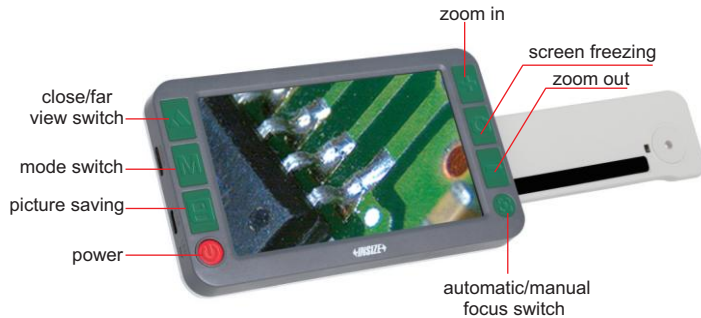

horizontal and vertical red lines

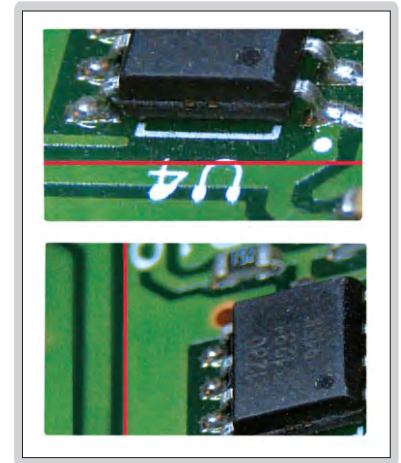

- 720P60 (close view) and 1080P30 (far view) cameras
- Double autofocus
- 26 color modes can be switched to meet the needs of different people
- Adopt folding bracket
- Detachable handle design, suitable for left-handed or right-handed use
- TV and HDMI ports to TV and display
- Automatic shutdown after 3 minutes

SPECIFICATION

Screen size	5 inch
Screen resolution	800×480
Magnification	2X-32X
Close view pixel	8M
Far view pixel	8M
Focus	manual/automatic
Color mode (26 modes)	color mode, color enhancement mode, negative mode, monochrome mode, black on white, white on black, blue on white, white on blue, yellow on black, black on yellow, yellow on blue, blue on yellow, green on white, white on green, orange on white, white on orange, red on black, black on red, orange on black, black on orange, yellow on green, green on yellow, red on white, white on red, yellow on white, white on yellow
Line	horizontal and vertical red lines
Function	screen freezing, image moving, photo playback, and high definition storage
Output	TV and HDMI
Storage	supports up to 32G TF card
Charging port	Type-C
Lithium battery	2500mAH (for 4 hours working)
Dimension (LxWxH)	145×30×85mm (when the handle is folded)
Weight	275g

after the handle is folded, the magnifier can be directly placed on the object for observation



side and back

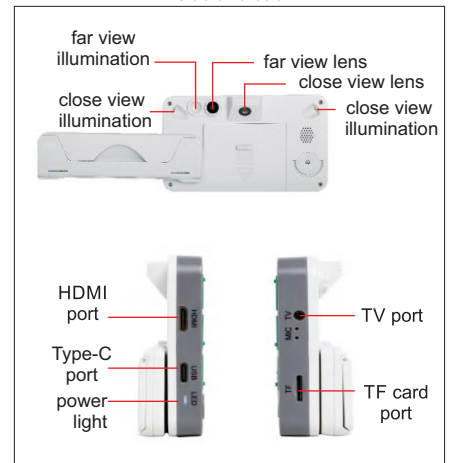

STANDARD DELIVERY

Main unit	1 pc
HDMI cable	1 pc
Video output cable	1 pc
USB charging cable	1 pc
Power adapter	1 pc

FOLDING MAGNIFIER

- Glass lens



7511-8



closed

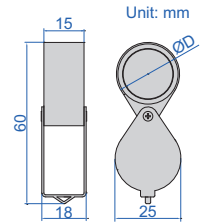

Unit: mm

Code	Magnification	Lens diameter (ØD)
7511-8	10X	Ø21mm

FOLDING MAGNIFIER WITH ILLUMINATION

- Resin lens
- Powered by 3xLR927 batteries (included)



2 pcs LED



7515-10



closed

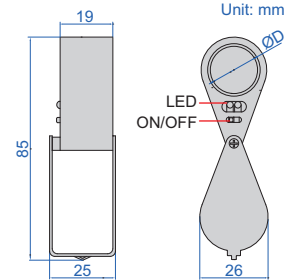

Unit: mm

Code	Magnification	Lens diameter (ØD)
7515-10	10X	Ø21mm

FOLDING MAGNIFIER WITH ILLUMINATION

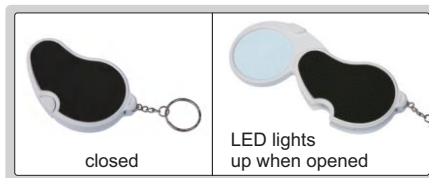

closed

LED lights up when opened



7514-1



LED

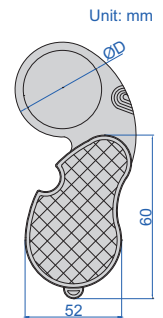

Unit: mm

- Resin lens
- Powered by 2xCR1620 batteries (included)
- LED lights up automatically when opened

Code	Magnification	Lens diameter (ØD)
7514-1	2.5X	Ø45mm

MAGNIFIER WITH ILLUMINATION

- Glass lens
- Powered by 3xAG7 batteries
- 3 pcs LED and 3 pcs UV
- Base with scale, graduation: 0.5mm, 1/16"

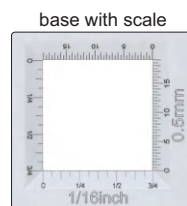

base with scale

rotate lens to adjust focus



7524-10

ON/OFF

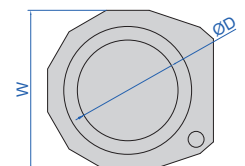
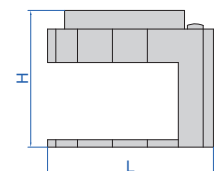

Code	Magnification	Lens diameter (ØD)	L	H	W
7524-10	10X	Ø30mm	60mm	50mm	56mm

MEASURING MAGNIFIERS (WITH ILLUMINATION)

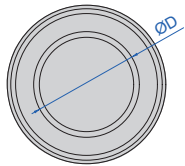
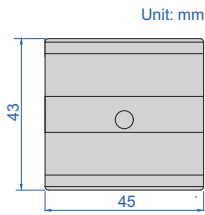

7527-D1

scale of 7527-D1
(graduation: 0.5mm)

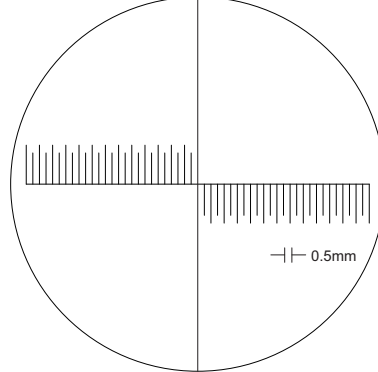

scale of 7527-D1B
(graduation: 0.1mm)

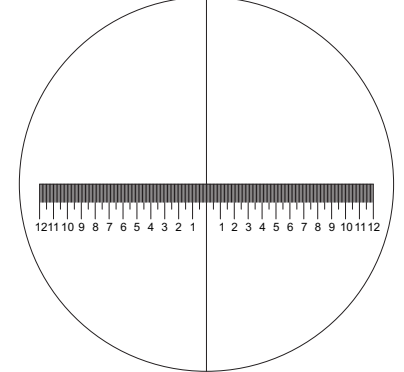

- Base with scale
- With 5 white LED and 5 UV LED
- Charging port: Type-C
- Work for 1.5h after fully charged

base with scale



scale of 7527-D2
(0-5mm graduation: 0.1mm, 5-10mm graduation: 0.5mm)

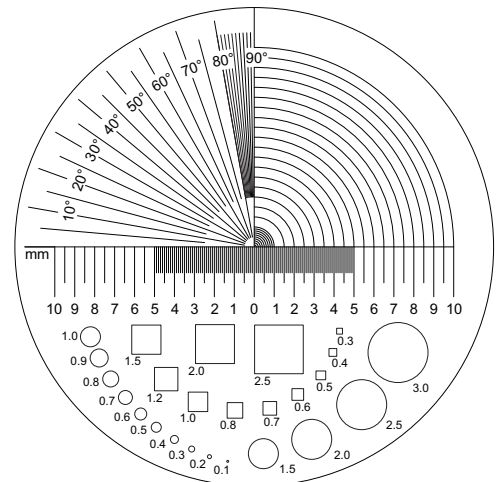

Code	Magnification	Lens diameter (ØD)
7527-D1	10X	Ø30mm
7527-D2	10X	Ø30mm
7527-D1B	10X	Ø30mm

MAGNIFIER WITH ILLUMINATION

- Glass lens
- With 4 white LED, three levels brightness adjustment
- Charging port: Type-C



7528-3

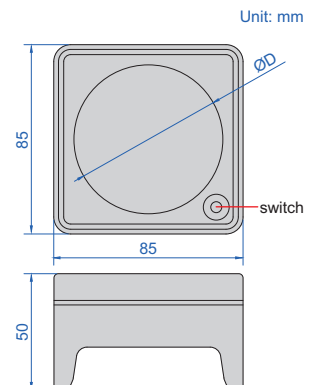

Code	Magnification	Lens diameter (ØD)
7528-3	3X	Ø70mm

MAGNIFIERS WITH ILLUMINATION



- Glass lens
- Powered by 3xAAA batteries (included)



7513-2

7513-4

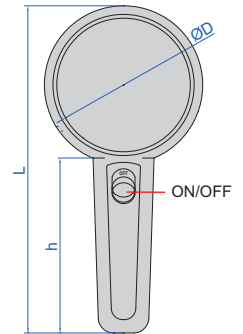

Code	Magnification	Lens diameter (ØD)	L	h
7513-2	2X	Ø75mm	170mm	90mm
7513-4	4X	Ø50mm	145mm	90mm

MAGNIFIER WITH ILLUMINATION

- Resin lens
- With 20 white LED, three levels brightness adjustment
- Charging port: Type-C



2X

4X

7529-24

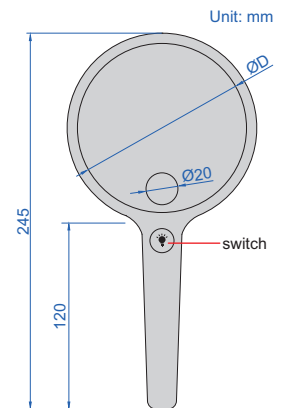

Code	Magnification	Lens diameter (ØD)
7529-24	2X/4X	Ø105mm

MAGNIFIER WITH TWO LENSES

- Resin lens
- Interchangeable lenses
- Powered by 3 pcs AAA batteries (included)



6X

10X

7522-610

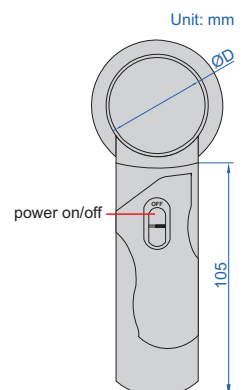

Code	Lens number	Magnification	Lens diameter (ØD)
7522-610	2 pcs	6X	50mm
		10X	37mm



THREE WAYS MAGNIFIER WITH ILLUMINATION

three ways use



7512-1

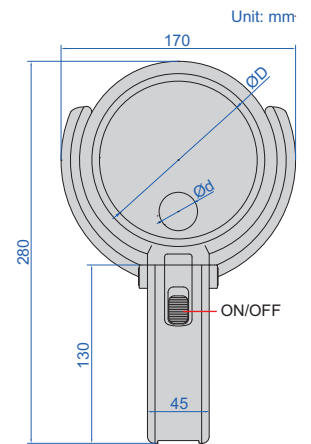

- Resin lens
- Powered by 2xAA batteries (included) or power adapter (110~240V, 50~60Hz)

Code	Magnification	Lens diameter (ØD/Ød)
7512-1	2X/4X	Ø120mm/Ø28mm



MAGNIFICATION GLASSES



7523-3D5

interchangeable lenses



adjustable lens and LED angle

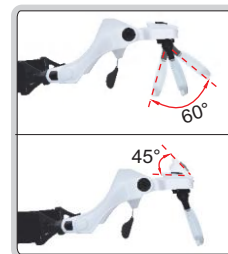

head band (included)



- Resin lens
- Interchangeable lenses
- Powered by 3 pcs AAA batteries (included)

Code	Lens number	Magnification
7523-3D5	5 pcs	1X
		1.5X
		2X
		2.5X
		3.5X

adjustable holder angle



moveable lens for focus



2 pcs LED



MAGNIFIER

using on table



hanging around neck



- Resin lens
- Silicone hose can be shaped according to needs
- Can be used on table or hanging around neck



7530-1D8

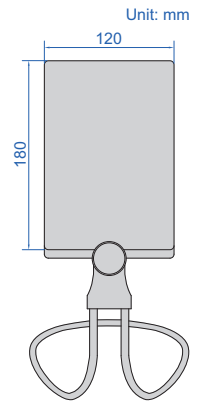

Code	Magnification	Lens size
7530-1D8	1.8X	180×120mm

TELESCOPING INSPECTION MIRRORS

- Inspect hidden areas
- Rotation of the mirror: 360°
- Length of handle is adjustable, handle is made of stainless steel

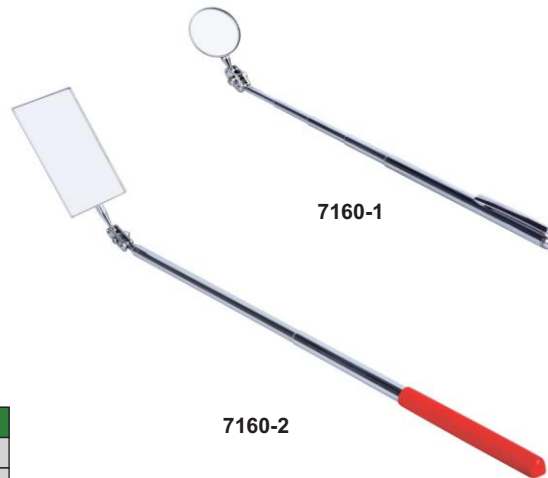

7160-1

7160-2

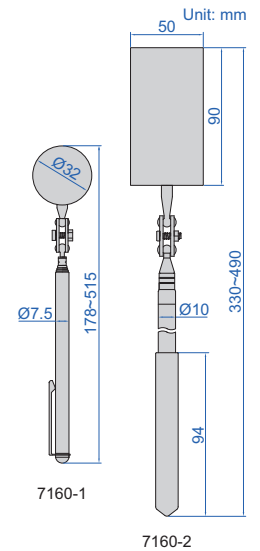

Code	Size of mirror	Length
7160-1	Ø32mm	178~515mm
7160-2	50×90mm	330~490mm

TELESCOPING INSPECTION MIRROR (WITH ILLUMINATION)

- Inspect hidden areas
- Head can bend and rotate
- Telescoping handle, made of stainless steel
- With two CR2032 batteries

head can bend and rotate



handle length is adjustable



7162-1

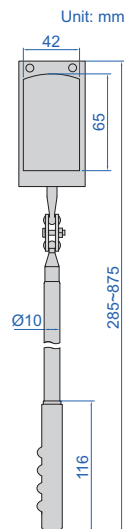

Code	Size of mirror	Length
7162-1	65×42mm	285~875mm

TELESCOPING MAGNETIC PICK-UP AND FLASHLIGHT



7163-1



magnetic head



magnetic end to attach on steel surfaces



head can bend, handle length is extendible

handle is closed

- For illumination and pick up steel parts in hidden areas
- Head can bend
- Telescoping handle, made of stainless steel
- Magnetic head and end
- With four LR44 batteries

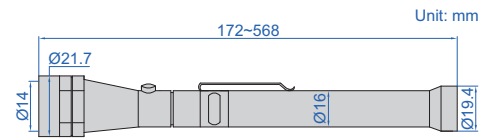

Code	Magnetic force of the end	Magnetic force of the head	Flashlight range	Battery life	Length
7163-1	4kgf	2kgf	3m	8h	172-568mm

TELESCOPING MAGNETIC PICK-UP



7161-1

- Pick up steel parts from hidden areas
- Rotation of magnetic head: 360°
- Length of handle is adjustable, handle is made of stainless steel

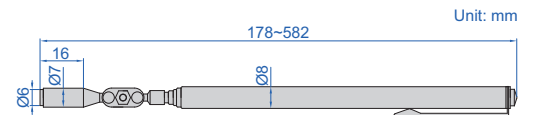

Code	Size of magnetic tip	Magnetic force	Length
7161-1	Ø6mm	0.45kgf	178-582mm



Videoscopes
Page 774-788



Carbon Fiber Telescopic
Pole Videoscopes
Page 789



Rigid Borescopes
Page 790

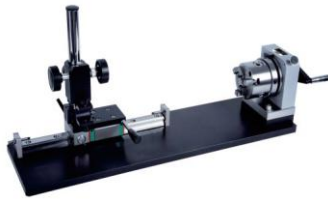

Fixture For Rigid Borescopes
Page 792

REAR FIBER ILLUMINATION



VIDEOSCOPE (DESK TYPE)

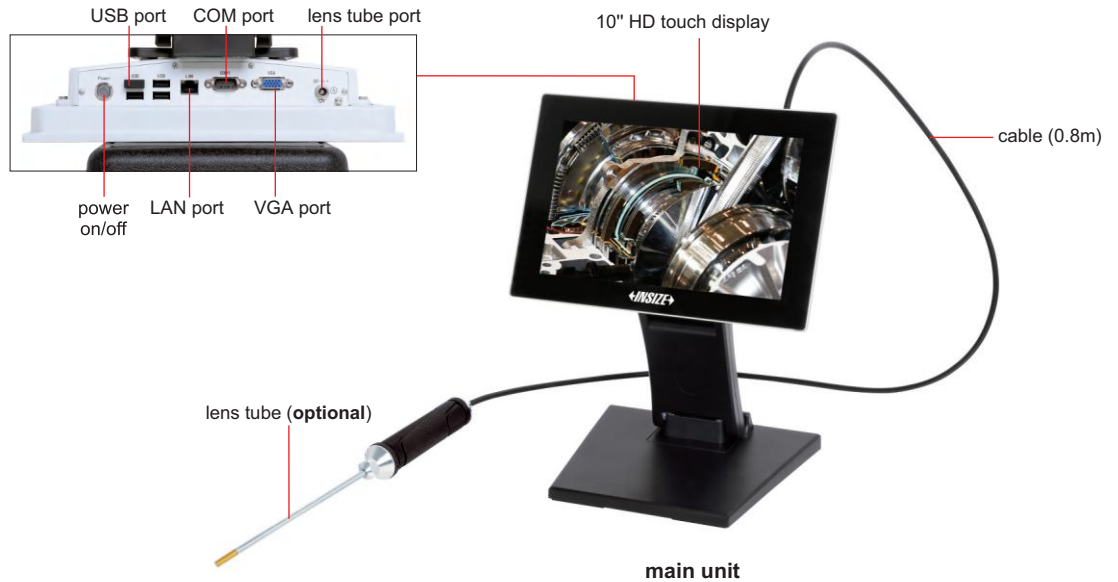

MAIN UNIT (WITHOUT LENS TUBE)

Code	ISV-Y
Display	10" HD touch display
Function	take picture, take video
File format	picture: JPG, video: MP4
Memory	built-in hard disk or USB flash disk
Image process	image zoom (1X, 2X, 3X)
Image control	noise reduction, negative film, flip over, freeze, on-line edit
Illumination	stepless adjustment
Additional function	real-time dynamic annotation, real-time watermark, rapid defect mark
Output	USB
Power supply	AC/DC adapter (for continuous working)
Weight	1000g

STANDARD DELIEVERY

Main unit	1 pc
USB disk	1 pc
Mouse	1 pc
AC/DC adapter	1 pc

OPTIONAL ACCESSORY

Lens tube	refer to below details
Software for automatic defect identification	can be customized

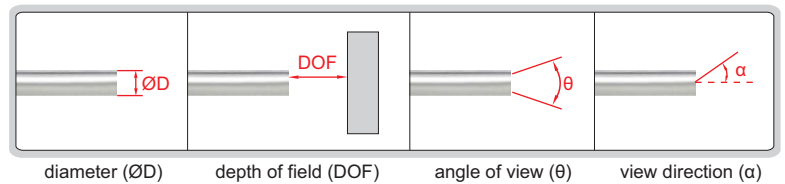

RIGID STRAIGHT LENS TUBE, FRONT VIEW

Code	Lens tube		pixel	illumination	angle of view (θ)	Lens		dust/ waterproof
	diameter (ØD)	length (L)				depth of field (DOF)	view direction (α)	
ISV-Y1210	1.2mm	90mm	0.04M	rear optical fiber	120°	3~70mm	0°	IP67
ISV-Y1810	1.8mm	120mm (optional 90-150mm)	0.16M			3~70mm	0°	
ISV-Y2010	2.0mm	120mm (optional 90-150mm)	0.16M			3~70mm	0°	
ISV-Y2410	2.4mm	150mm (optional 90-300mm)	0.16M			3~70mm	0°	
ISV-Y2810	2.8mm	150mm (optional 90-300mm)	0.16M			3~70mm	0°	
ISV-Y3910	3.9mm	200mm (optional 90-500mm)	1M			8~150mm	0° (optional 30°, 70°)	
ISV-Y6010	6.0mm	300mm (optional 90-1000mm)	1M			12~200mm	0° (optional 30°, 70°)	

To be continued

Continued from previous page

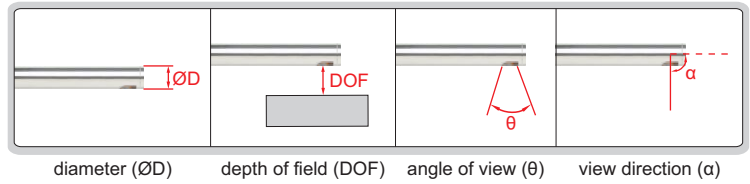

RIGID STRAIGHT LENS TUBE, SIDE VIEW

Code	Lens tube		Lens					
	diameter (ØD)	length (L)	pixel	illumination	angle of view (θ)	depth of field (DOF)	view direction (α)	dust/ waterproof
ISV-Y2810C	2.8mm	150mm (optional 90-300mm)	0.16M	rear optical fiber	120°	3~70mm	90°	IP67
ISV-Y3910C	3.9mm	200mm (optional 90-500mm)	1M			8~150mm		
ISV-Y4510C	4.5mm	250mm (optional 90-800mm)	1M			8~150mm		
ISV-Y6010C	6.0mm	300mm (optional 90-1000mm)	1M			12~200mm		

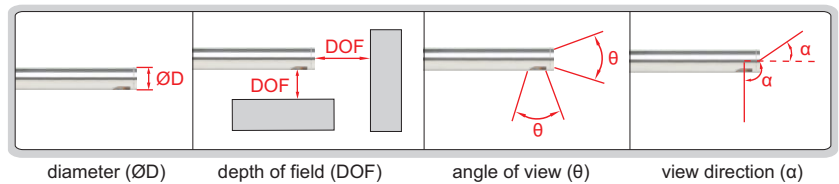

RIGID STRAIGHT LENS TUBE, FRONT VIEW & SIDE VIEW

Code	Lens tube		Lens					
	diameter (ØD)	length (L)	pixel	illumination	angle of view (θ)	depth of field (DOF)	view direction (α)	dust/ waterproof
ISV-Y6010S	6.0mm	300mm (optional 90-1000mm)	1M	rear optical fiber	120°	front view: 12~200mm side view: 8~150mm	front view: 0° side view: 90°	IP67

25

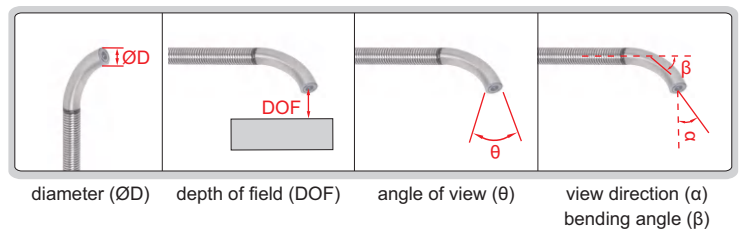

BENDING SPRING LENS TUBE

Code	Lens tube		Lens						
	diameter (ØD)	length (L)	pixel	illumination	angle of view (θ)	depth of field (DOF)	view direction (α)	bending angle (β)	dust/ waterproof
ISV-Y3010W	3.0mm	1000mm	0.16M	rear optical fiber	120°	8~150mm	0°	75° (can be customized)	IP65
ISV-Y5010W	5.0mm		1M			8~150mm			
ISV-Y7010W	7.0mm		1M			12~200mm			

REAR FIBER ILLUMINATION

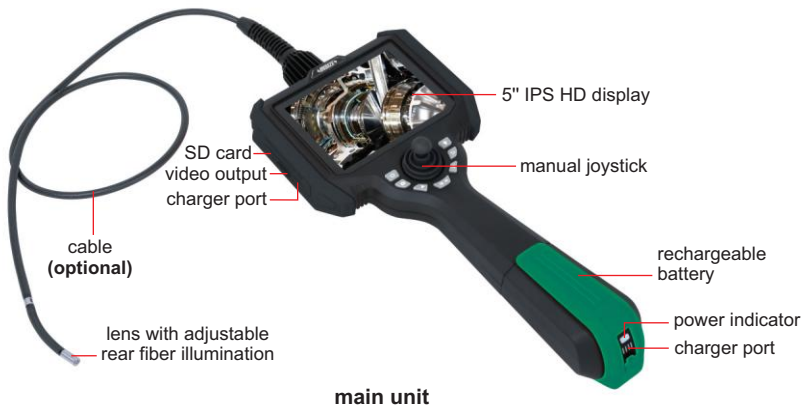

VIDEOSCOPE (CABLE IS OPTIONAL)



changeable lens cable



tripod (included)



ISV-L-HOOK (optional)



ISV-L-MAGNET (optional)



WIFI real-time image transmission

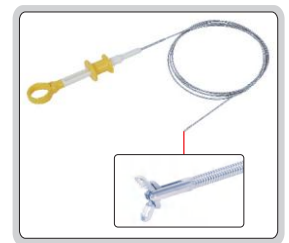

ISV-L-CLAMP (optional)

MAIN UNIT (WITHOUT CABLE)

Code	ISV-L
Display	5" high definition LCD
Resolution	1024×720
Function	take pictures, take videos
File format	picture: JPG, video: MP4
Image process	image zoom (1X, 2X, 3X, 4X)
Image control	freeze, flip over, playback and analog ruler
Memory	memory card
Output	WIFI (only for Android OS), USB, HDMI
Power supply	rechargeable lithium battery (working time ≥ 4hours) AC/DC adapter (for continuous working)
Weight	1000g

OPERATION ENVIRONMENT

Main unit	-10~50°C, no preheat
Operation temperature	-20~70°C
Storage temperature	-20~60°C
Relative humidity	maximum 90%, no condensation

STANDARD DELIVERY

Main unit	1 pc
32G SD card	1 pc
Card reader	1 pc
USB cable	1 pc
Tripod	1 pc
AC/DC adapter	1 pc

OPTIONAL ACCESSORY

Cable	please refer to details
Temperature alarm	ISV-L-HTALARM (must be installed in factory, for Ø3.9mm, Ø4.5mm and Ø6.0mm)
Hook	ISV-L-HOOK (must be installed in factory, for Ø3.9mm, Ø4.5mm and Ø6.0mm)
Magnet	ISV-L-MAGNET (must be installed in factory, for Ø3.9mm, Ø4.5mm and Ø6.0mm)
Clamp	ISV-L-CLAMP

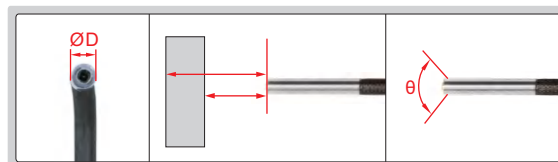

diameter (ØD) depth of field (DOF) angle of view (θ)

ONE-DIRECTION CABLE (NO BENDING), FRONT VIEW

Code	Cable		Lens							
	length	type	view direction	diameter (ØD)	depth of field (DOF)	angle of view (θ)	illumination	pixel	resolution	dust/ waterproof
ISV-L09505	0.5m	spring tube	front view	0.95mm	3~30mm	>120°	rear fiber	0.16M	400×400	IP65
ISV-L09510	1m			1.2mm	3~30mm					
ISV-L1210	1m			1.5mm	3~70mm					
ISV-L1510	1m	tungsten wire weaved cable		1.5mm	3~70mm					
ISV-L1515	1.5m									

To be continued

Continued from previous page

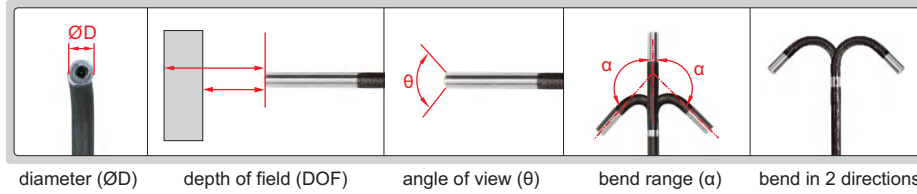

TWO-DIRECTION BENDING CABLE, FRONT VIEW

Code	Cable		Lens									
	length	type	view direction	bend direction	diameter (ØD)	depth of field (DOF)	bend range (α)	angle of view (θ)	illumination	pixel	resolution	dust/ waterproof
ISV-L1810	1m	tungsten wire weaved cable	front view	two directions	1.8mm	3~30mm	±160°	>120°	rear fiber	0.16M	400×400	IP65
ISV-L2010	1m				2.0mm	3~30mm						
ISV-L2410	1m				2.4mm	3~70mm (optional 5~100mm)						
ISV-L2415	1.5m											
ISV-L2420	2m											

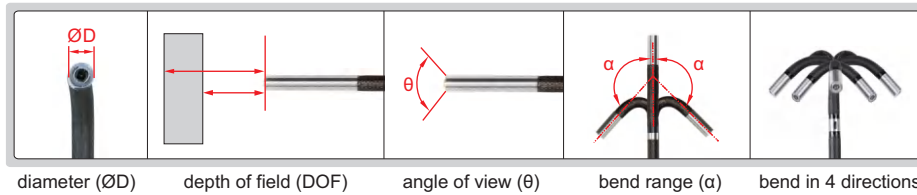

FOUR-DIRECTION BENDING CABLE, FRONT VIEW

Code	Cable		Lens									
	length	type	view direction	bend direction	diameter (ØD)	depth of field (DOF)	bend range (α)	angle of view (θ)	illumination	pixel	resolution	dust/ waterproof
ISV-L2810	1m	tungsten wire weaved cable	front view	four directions	2.8mm	3~70mm (optional 5~100mm)	±160°	>120°	rear fiber	0.16M	400×400	IP65
ISV-L2815	1.5m											
ISV-L2820	2m											
ISV-L2830	3m				3.9mm	8~150mm (optional 3~70mm)						
ISV-L3910	1m											
ISV-L3915	1.5m											
ISV-L3920	2m				6.0mm	12~200mm (optional 3~70mm, 8~150mm)						
ISV-L3930	3m											
ISV-L3940	4m											
ISV-L3950	5m				0.92M	1280×720				IP67		
ISV-L6010	1m											
ISV-L6015	1.5m											
ISV-L6020	2m											
ISV-L6030	3m											
ISV-L6040	4m											
ISV-L6050	5m											
ISV-L6060	6m											
ISV-L6070	7m											

To be continued

Continued from previous page

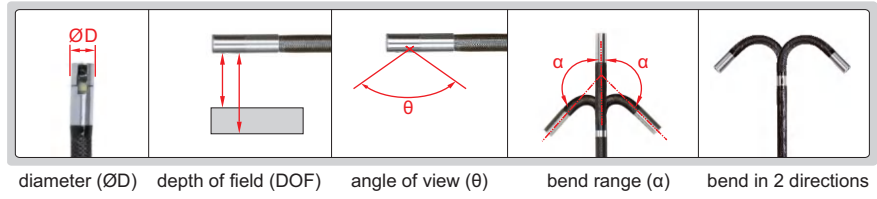

TWO-DIRECTION BENDING CABLE, SIDE VIEW

Code	Cable		Lens									
	length	type	view direction	bend direction	diameter (ØD)	depth of field (DOF)	bend range (α)	angle of view (θ)	illumination	pixel	resolution	dust/ waterproof
ISV-L1810C	1m	tungsten wire weaved cable	side view	two directions	1.8mm	3~30mm	±160°	>120°	rear fiber	0.16M	400×400	IP65
ISV-L1815C	1.5m											

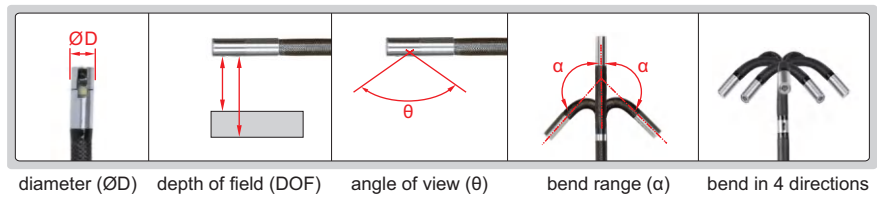

FOUR-DIRECTION BENDING CABLE, SIDE VIEW

Code	Cable		Lens									
	length	type	view direction	bend direction	diameter (ØD)	depth of field (DOF)	bend range (α)	angle of view (θ)	illumination	pixel	resolution	dust/ waterproof
ISV-L2810C	1m	tungsten wire weaved cable	side view	four directions	2.8mm	3~70mm	±160°	>120°	rear fiber	0.16M	400×400	IP65
ISV-L2815C	1.5m											
ISV-L2820C	2m											
ISV-L2830C	3m											
ISV-L4510C	1m											
ISV-L4515C	1.5m				5~100mm (optional 8~150mm)							
ISV-L4520C	2m											
ISV-L4530C	3m											
ISV-L6010C	1m											
ISV-L6015C	1.5m											
ISV-L6020C	2m				8~150mm (optional 5~100mm)							
ISV-L6030C	3m											
ISV-L6040C	4m											
ISV-L6050C	5m											

FRONT AND SIDE VIEW VIDEOSCOPE (CABLE IS OPTIONAL)

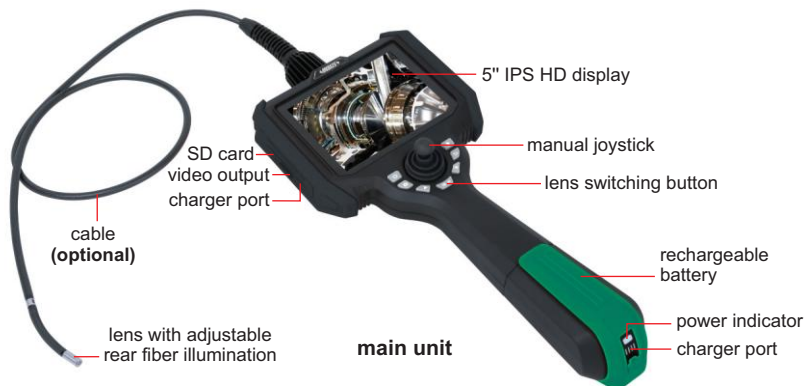

REAR FIBER ILLUMINATION



To be continued

Continued from previous page



WiFi real-time image transmission

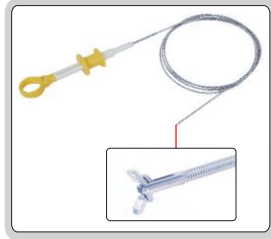

ISV-K-CLAMP (optional)



changeable lens cable



tripod (included)



ISV-S-HOOK (optional)



ISV-S-MAGNET (optional)

OPTIONAL ACCESSORY

Cable	please refer to details
Temperature alarm	ISV-S-HTALARM (must be installed in factory, for Ø3.9mm, Ø6.0mm)
Hook	ISV-S-HOOK (must be installed in factory, for Ø3.9mm, Ø6.0mm)
Magnet	ISV-S-MAGNET (must be installed in factory, for Ø3.9mm, Ø6.0mm)
Clamp	ISV-K-CLAMP

MAIN UNIT (WITHOUT CABLE)

Code	ISV-S
Display	5" high definition LCD
Resolution	1024×720
Function	take pictures, take videos
File format	picture: JPG, video: MP4
Image process	image zoom (1X, 2X, 3X, 4X)
Image control	freeze, flip over, playback and analog ruler
Memory	memory card
Output	WiFi (only for Android OS), USB, HDMI
Power supply	rechargeable lithium battery (working time ≥ 4hours) AC/DC adapter (for continuous working)
Weight	1000g

STANDARD DELIEVERY

Main unit	1 pc
32G SD card	1 pc
Card reader	1 pc
USB cable	1 pc
Tripod	1 pc
AC/DC adapter	1 pc

OPERATION ENVIRONMENT

Main unit	-10~50°C, no preheat
Operation temperature	-20~70°C
Storage temperature	-20~60°C
Relative humidity	maximum 90%, no condensation

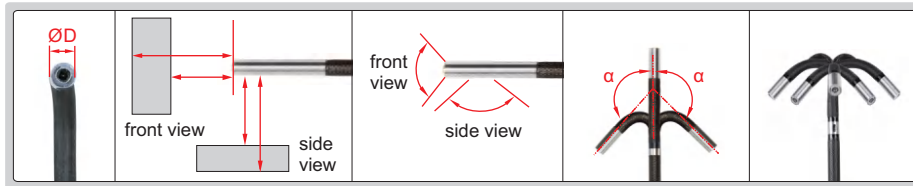

diameter (ØD) depth of field (DOF) angle of view (θ) bend range (α) bend in 4 directions

FOUR-DIRECTION BENDING CABLE, FRONT VIEW&SIDE VIEW

Code	Cable		Lens									
	length	type	view direction	bend direction	diameter (ØD)	depth of field (DOF)	bend range (α)	angle of view (θ)	illumination	pixel	resolution	dust/ waterproof
ISV-S2810	1m	tungsten wire weaved cable	front view and side view	four directions	2.8mm	front view: 3~70mm side view: 3~70mm	±160°	>120°	front LED	0.16M	400×400	IP65
ISV-S2815	1.5m											
ISV-S2820	2m											
ISV-S2830	3m											
ISV-S3910	1m	tungsten wire weaved cable	front view and side view	four directions	3.9mm	front view: 7~150mm side view: 5~80mm	±160°	>120°	rear fiber	0.92M	1280×720	IP67
ISV-S3915	1.5m											
ISV-S3920	2m											
ISV-S3930	3m											
ISV-S3940	4m											
ISV-S3950	5m											
ISV-S6010	1m	tungsten wire weaved cable	front view and side view	four directions	6.0mm	front view: 12~200mm (optional 3~70mm) side view: 8~150mm (optional 3~70mm)	±160°	>120°	rear fiber	0.92M	1280×720	IP67
ISV-S6015	1.5m											
ISV-S6020	2m											
ISV-S6030	3m											
ISV-S6040	4m											
ISV-S6050	5m											

REAR FIBER ILLUMINATION

VIDEOSCOPIES (WITH CABLE)



ISV-K6015



WIFI real-time image transmission



changeable lens cable

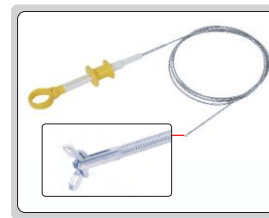

ISV-K-CLAMP (optional)



ISV-K-MAGNET (optional)



ISV-K-HOOK (optional)

SPECIFICATION

Code	ISV-K1810	ISV-K2410	ISV-K2810	ISV-K3915	ISV-K6015	
Lens	diameter (ØD)	1.8mm	2.4mm	2.8mm	3.9mm	6.0mm
	pixel	0.16M			0.92M	
	resolution	400×400			1280×720	
	depth of field	3-30mm	3-70mm	3-70mm	8-150mm	12-200mm
	bending direction	two directions	two directions	four directions	four directions	four directions
	bending range (α)	±160°				
	angle of view (θ)	120°				
	illumination	rear fiber				
	lens	sapphire glass lens				
	dust/waterproof	IP65			IP67	
Cable	bend control	manual joystick				
	length	1m	1m	1m	1.5m	1.5m
Main unit	type	tungsten wire weaved cable				
	display	5" high definition LCD				
	function	take pictures, take videos				
	file format	picture: JPG, video: MP4				
	image process	image zoom (1X, 2X, 3X, 4X)				
	image control	freeze, flip over, playback and analog ruler				
	memory	memory card				
	output	WIFI (only for Android OS), USB, HDMI				
Weight	power supply	rechargeable lithium battery (working time ≥ 4 hours), AC/DC adapter (for continuous working)				
		1000g				

To be continued

Continued from previous page

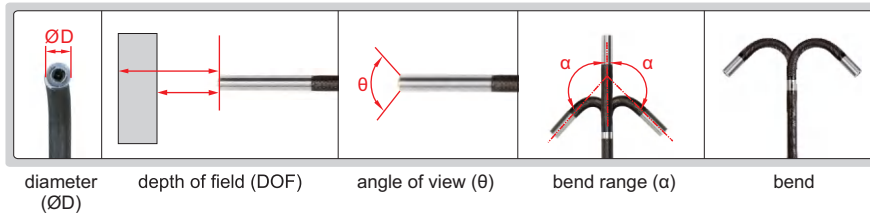

STANDARD DELIEVERY

Main unit (with cable)	1 pc
32G SD card	1 pc
Card reader	1 pc
USB cable	1 pc
Tripod	1 pc
AC/DC adapter	1 pc

OPERATION ENVIRONMENT

Main unit	-10~50°C, no preheat
Operation temperature	-20~70°C
Storage temperature	-20~60°C
Relative humidity	maximum 90%, no condensation

OPTIONAL ACCESSORY

Temperature alarm	ISV-K-HTALARM (must be installed in factory, for ISV-K3915 and ISV-K6015)
Hook	ISV-K-HOOK (must be installed in factory, for ISV-K3915 and ISV-K6015)
Magnet	ISV-K-MAGNET (must be installed in factory, for ISV-K3915 and ISV-K6015)
Clamp	ISV-K-CLAMP

UV VIDEOSCOPIES (WITH CABLE)

UV OPTICAL FIBER ILLUMINATION

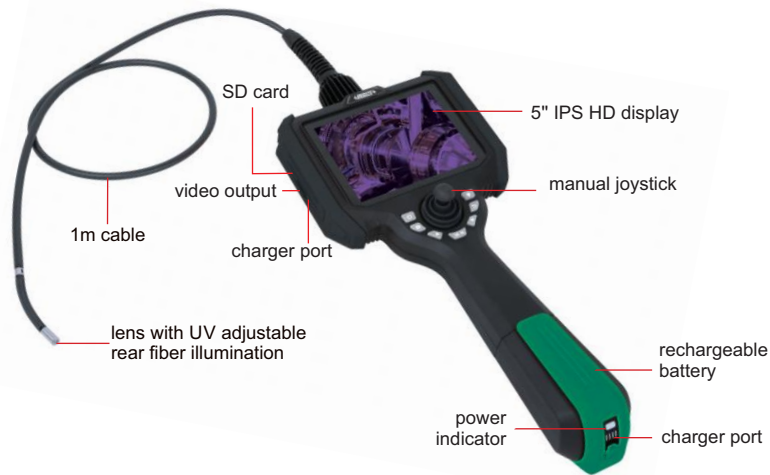

ISV-U6010



tripod (included)



WIFI real-time image transmission



changeable lens cable

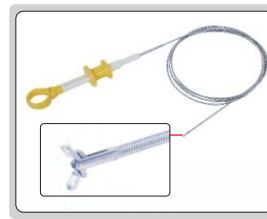

ISV-K-CLAMP (optional)



ISV-U-MAGNET (optional)



ISV-U-HOOK (optional)

To be continued

Continued from previous page

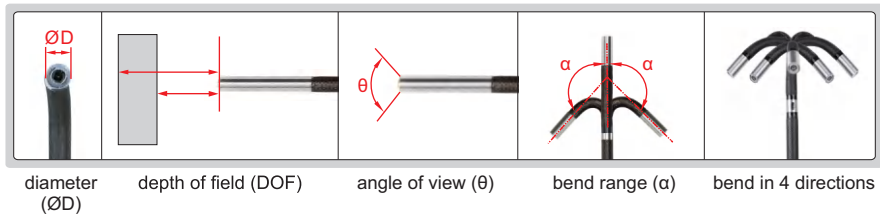

TECHNICAL PARAMETER

Code		ISV-U6010	ISV-U6020	ISV-U6030	ISV-U8010	ISV-U8020	ISV-U8030
Camera	diameter (ØD)	Ø6mm			Ø8mm		
	pixel	1M					
	lens length	13±0.5mm					
	depth of field (DOF)	10~200mm (optional 50mm~∞)					
	bend direction	four directions					
	bend ramher (a)	±150°	±130°	±100°	±150°	±130°	±100°
	angel of view (θ)	120°					
	lighting	rear UV fiber optic illumination					
	ultraviolet wavelength	365nm					
	waterproof grade	IP67					
Cable	length	1m	2m	3m	1m	2m	3m
	type	soft (tungsten wire weaved cable)					
Main unit	display	5" HD IPS display screen					
	file format	picture: JPG, video: AVI					
	image control	freezing, zoom, flip over, playback and analog ruler					
	memory	memory card					
	output	WIFI (only for Android OS), USB, HDMI					
power supply	rechargeable lithium battery (working time ≥ 4hours), AC/DC adapter (for continuous working)						
Weight	1000g						

STANDARD DELIEVERY

Main unit (with cable)	1 pc
32G SD card	1 pc
Card reader	1 pc

USB cable	1 pc
Tripod	1 pc
AC/DC adapter	1 pc

OPERATION ENVIRONMENT

Main unit	-10~50°C, no preheat
Operation temperature	-20~70°C
Storage temperature	-20~60°C
Relative humidity	maximum 90%, no condensation

OPTIONAL ACCESSORY

Hook	ISV-U-HOOK (must be installed in factory)
Magnet	ISV-U-MAGNET (must be installed in factory)
Clamp	ISV-K-CLAMP

VIDEOSCOPES (BASIC TYPE)

TUNGSTEN WIRE WEAVED CABLE
BREAK AND WEAR RESISTANCE

IP67
WATERPROOF

POPULAR
MODEL



WIFI real-time image transmission

replaceable lens cable



ISV-J6010

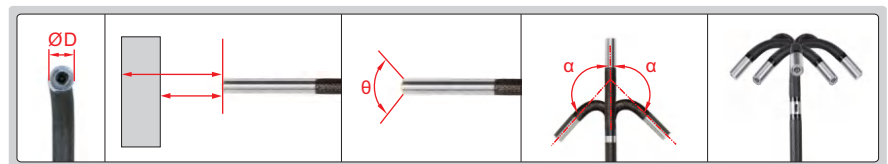

diameter (ØD) depth of field (DOF) angle of view (θ) bend range (α) bend in 4 directions

SPECIFICATION

Code	ISV-J2810	ISV-J2815	ISV-J4010	ISV-J4030	ISV-J6010	ISV-J6030
Lens	diameter (ØD)	2.8mm	2.8mm	4.0mm	4.0mm	6.0mm
	pixel	0.16M		1M		
	resolution	400×400		1280×720		
	depth of field	10~∞mm				
	bending direction	four directions				
	bending range (α)	±160°				
	angle of view (θ)	120°				
	illumination	front LED				
	lens	sapphire glass lens				
	dust/waterproof	IP67				
	bend control	manual joystick				
	Cable	length	1m	1.5m	1m	3m
type		wire weaved cable				
Main unit	display	5" HD screen (resolution: 1920x1080)				
	function	take pictures, take videos				
	file format	picture: JPG, video: MOV				
	image process	image zoom (1X, 2X, 3X, 4X, 5X)				
	image control	freeze, flip over, playback, analog ruler				
	memory	32G memory card				
	output	WIFI (only for Android OS), USB, HDMI				
power supply	rechargeable lithium battery (working time ≥ 4 hours), AC/DC adapter (for continuous working)					
Weight	1000g					

To be continued

Continued from previous page

STANDARD DELIVERY

Main unit	1 pc
32G SD card	1 pc
Card reader	1 pc
USB cable	1 pc
AC/Dc adapter	1 pc

OPERATION ENVIRONMENT

Main unit	-10~50°C, no preheat
Operation temperature	-20~70°C
Storage temperature	-20~60°C
Relative humidity	maximum 90%, no condensation



**MOBILE PHONE VIDEOSCOPE
CODE ISV-P6**



the clamping range of mobile phone bracket L=56-95mm

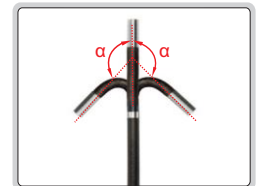

bending of lens up to 180°



angle of view



lens with LED

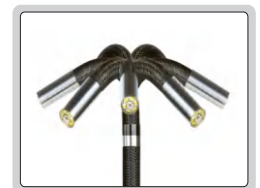

bend in any direction

- For Android and iOS mobile phones

SPECIFICATION

Diameter of lens (ØD)	6±0.2mm
Length of cable	1m
Resolution	960×720, 1280×720 (switchable)
Depth of field	20mm~∞
Angle of view (θ)	100°
Bending range (α)	0~180°
Illumination	LED with 3 levels control
Cable type	wear resistant
Interface	USB, Type-C
Mobile phone system	Android, iOS
Power supply	rechargeable battery (for 2 hours working)
Dimension (L×W×H)	195×57×105mm
Weight	450g

STANDARD DELIVERY

Main unit (with cable)	1 pc
Type-C cable	1 pc
Micro USB cable	1 pc
Iphone cable	1 pc
Charging cable	1 pc

VIDEOSCOPE (BASIC TYPE) CODE ISV-E40

MEMORY CABLE CAN
BE FIXED AT ANY SHAPE

IP67
WATERPROOF



magnet pick up (included)



hook (included)



45° mirror (included)

SPECIFICATION

Lens	diameter (ØD)	8mm
	pixel	0.92M
	resolution	1280x720
	depth of field	30~80mm
	angle of view	77°
	illumination	3 levels
	dust/waterproof	IP67
Cable	length	1180mm
	type	memory (can be set at any shape)
Main unit	display	5" IPS LCD
	function	take picture, take video
	file format	picture: JPG, video: MOV
	image process	image zoom (1.5X, 2X, 3X, 4X)
	memory	memory card (optional)
	output	Type-C
	power supply	rechargeable lithium battery (for 5 hours working)
dimension	217×155×131mm	
Weight	506g	

STANDARD DELIVERY

Main unit	1 pc
45° mirror	1 pc
Hook	1 pc
Magnet pick up	1 pc

OPTIONAL ACCESSORY

32G memory card	ISV-E40-CARD
Card reader	ISV-E40-READER

OPERATION ENVIRONMENT

Operation temperature	-10~50°C
Storage temperature	-20~60°C
Operation humidity	15%~85%

MEMORY CABLE CAN
BE FIXED AT ANY SHAPE

IP67
WATERPROOF

VIDEOSCOPE (ECONOMIC TYPE)
CODE ISV-E30

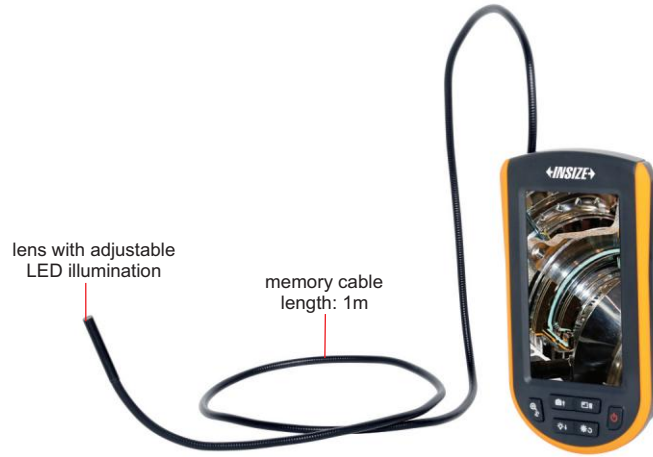

magnet pick up (included)



hook (included)



cable can be wrapped around
the main unit

SPECIFICATION

Lens	diameter	5.2mm
	pixel	0.4M
	depth of field	30~80mm
	angle of view	72°
	illumination	8 levels
	dust/waterproof	IP67
Cable	length	1m
	type	memory (can be set at any shape)
Main unit	display	4.3" LCD
	function	take picture, take video
	file format	picture: JPG, video: AVI
	image zoom	2X
	memory card	memory card (optional)
	output	micro USB
	power supply	AA battery
dimension	154×32.5×87.5mm	
Weight		280g

STANDARD DELIVERY

Main unit	1 pc
Hook	1 pc
Magnet pick up	1 pc
AA battery	4 pcs

OPTIONAL ACCESSORY

32G memory card	ISV-E40-CARD
Card reader	ISV-E40-READER

OPERATION ENVIRONMENT

Operation temperature	-10~50°C
Storage temperature	-20~60°C
Operation humidity	15%~85%

MULTIPURPOSE VIDEOSCOPE

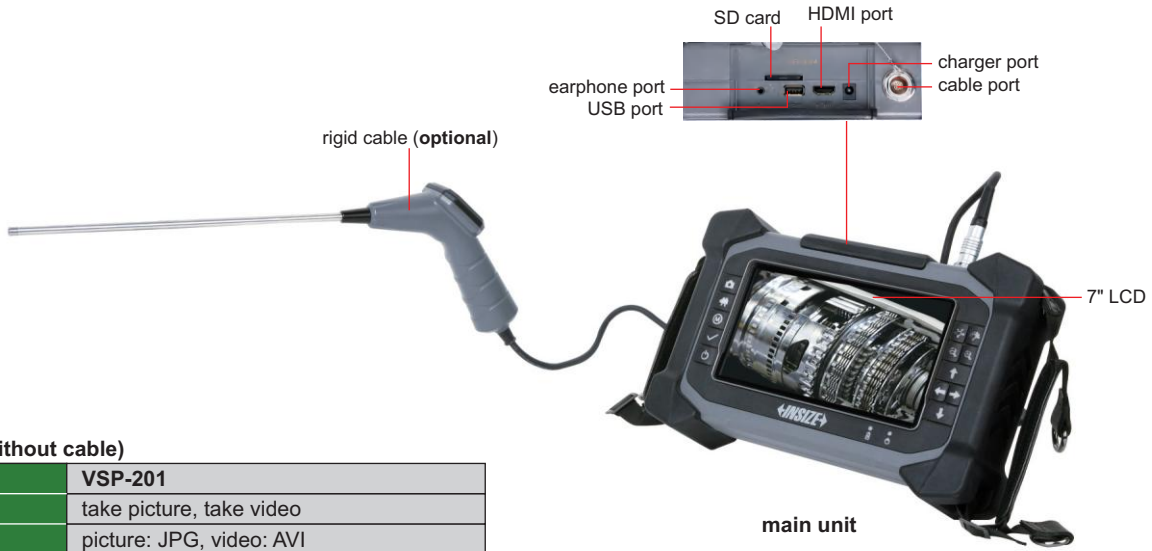

MAIN UNIT (without cable)

Code	VSP-201
Function	take picture, take video
File format	picture: JPG, video: AVI
Image process	brightness, contrast
Memory	64GB
Output	HDMI, USB
Power supply	rechargeable battery (for 4 hours working)
Dimension	260×170×65mm
Weight	1.2kg

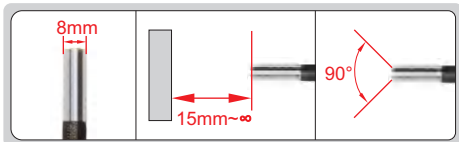

diameter (ØD) focus distance (F) angle of view (θ)



bend in any direction 360° swivel in clockwise and counter-clockwise bend within 120°

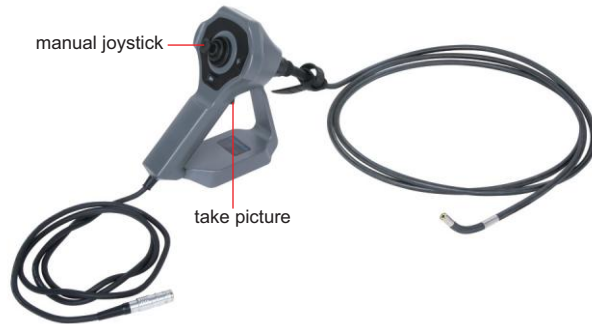

FOUR-DIRECTION BENDING CABLE (FRONT VIEW)

Code	VSP-201D	
Cable	length	3m
	type	tungsten wire weaved cable
Lens	diameter (ØD)	8mm
	focus distance (F)	15mm~∞
	angle of view (θ)	90°
	illumination	6 pcs LED
	pixel	1M
	resolution	1280×720
dust/waterproof		IP67



To be continued

Continued from previous page



RIGID CABLE

Code	VSP-201H	
Cable	length (L)	250mm
	type	stainless steel
Lens	diameter (ØD)	6.4mm
	focus distance (F)	15mm~∞
	angle of view (θ)	90°
	illumination	6 pcs LED
	pixel	1M
	resolution	1280×720
	dust/waterproof	IP64

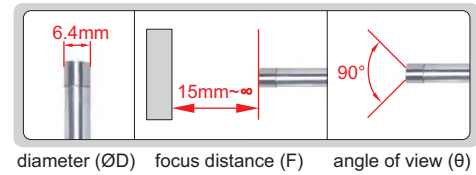

ROTATING LENS CABLE

Code	VSP-201R	
Cable	length	30m
	type	high strength glass fibre
Lens	diameter (ØD)	40mm
	focus distance (F)	3mm~∞
	angle of view (θ)	100°
	illumination	12 pcs LED
	pixel	1M
	resolution	1280×720
	dust/waterproof	IP67
lens control	motorized	

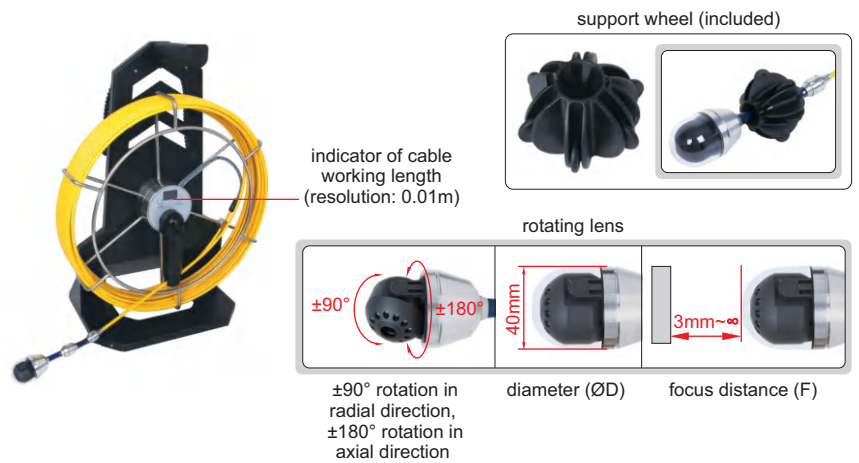

WIDE-ANGLE LENS CABLE

Code	VSP-201W	
Cable	length	30m
	type	high strength glass fibre
Lens	diameter (ØD)	24mm
	focus distance (F)	25mm~∞
	angle of view (θ)	100°
	illumination	12 pcs LED
	pixel	1M
	resolution	1280×720
dust/waterproof	IP67	

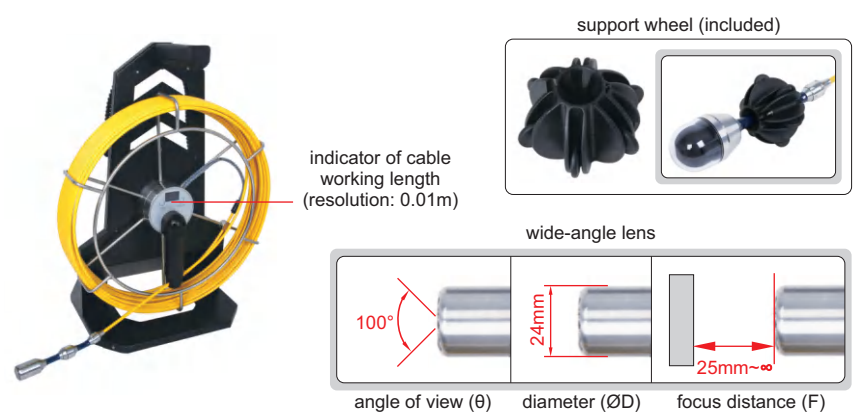

ADJUSTABLE SUPPORT

Code	Working diameter (ØD)	Remark
VSP-201-R200	60~200mm	for VSP-201R or VSP-201W



4K CARBON FIBER TELESCOPIC POLE VIDEOSCOPE CODE ISV-CF5



WiFi real-time image transmission

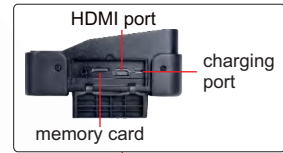

IP65
WATERPROOF



built-in infrared and white light for night and day use



dual motorized control of lens view, 300° horizontal and vertical 360° rotation

carbon fiber telescopic pole, length 1~5m (adjustable)

7" LCD touch screen



- Dual motorized control of lens view, 300° horizontal and vertical 360° rotation
- 4K HD true color camera
- Built-in infrared and white light for night and day use
- Insert SD card and export photos, videos

application scenario

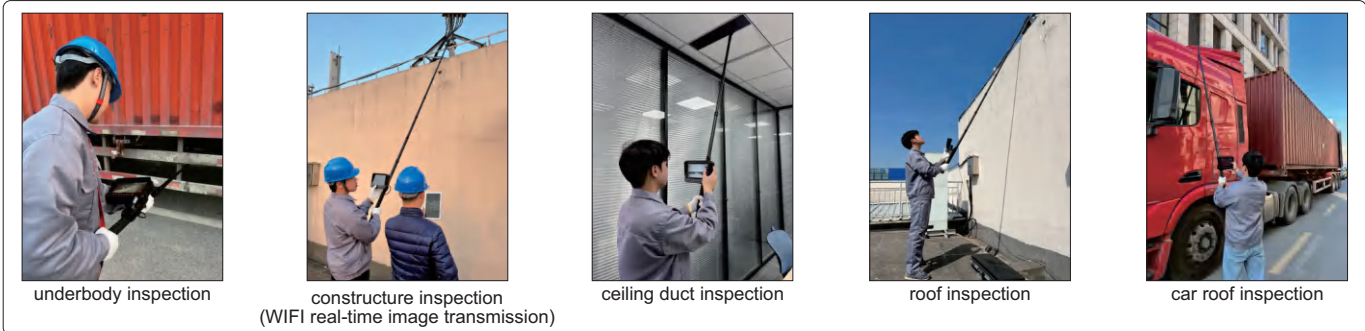

SPECIFICATION

Display	7" color touch LCD
Function	take photos and videos
Resolution	3840×2160
Image process	image mirror or flipping, real-time image magnification (1X, 2X, 3X, 4X)
Lens diameter (ØD)	40mm
Display image ratio	16:9, 4:3, 1:1
Memory	SD card (128G Max)
Illumination	infrared and white light LED, manual 5-level brightness adjustment
Output	HDMI
Wireless transmission	WiFi real-time image transmission
Pole	carbon fiber, can be fixed between 1~5 meters
Environmental requirement	temperature: -20°C~60°C, relative humidity: 10%~85%
Power supply	rechargeable battery (18650 lithium battery), power adapter (for continuous working)
Dust/waterproof	IP65
Weight	2kg

STANDARD DELIVERY

Main unit	1 pc
32G SD card	1 pc
Card reader	1 pc

Carbon fiber telescopic pole	1 pc
HDMI cable	1 pc
Power adapter	1 pc

IP67
WATERPROOF

RIGID BORESCOPIES

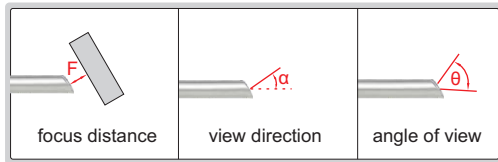
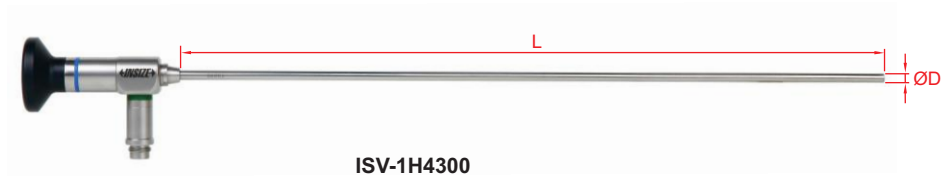

view direction $\alpha=30^\circ$ or 70°

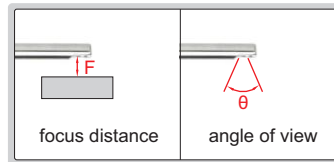

view direction $\alpha=90^\circ$

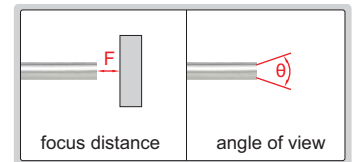

view direction 0°

- Focus distance: 2mm, depth of view: 5~100mm
- Dust/waterproof level: IP67
- Can be used in liquid with temperature $-10^\circ\text{C}\sim 85^\circ\text{C}$



LED light handle
(optional)



adjustable LED light source
(optional)



camera and display
(optional)

SPECIFICATION

Code	Length (L)	View direction (α)	Diameter ($\varnothing D$)	Angle of view (θ)
ISV-1H4170	174mm	0°	4mm	$\geq 60^\circ$
ISV-1H4173	174mm	30°		
ISV-1H4177	174mm	70°		
ISV-1H4179	166mm	90°		
ISV-1H4300	302mm	0°		
ISV-1H4303	302mm	30°		
ISV-1H4307	302mm	70°		

OPTIONAL ACCESSORY

LED light handle	ISV-1HLED
Adjustable LED light source	ISV-1LED1
Camera and display	ISV-2CAM

**LED LIGHT HANDLE
CODE ISV-1HLED**



battery (included)



charger (included)



- For rigid borescopes

SPECIFICATION

Power	3W
Battery	3.7V rechargeable battery (for 2 hours working)
Dimension	120×27×27mm
Weight	300g

STANDARD DELIVERY

Main unit	1 pc
Battery	1 pc
Charger	1 pc

**CAMERA (WITH DISPLAY)
CODE ISV-2CAM**

TAKE PICTURES
AND VIDEOS

AUTO FOCUS

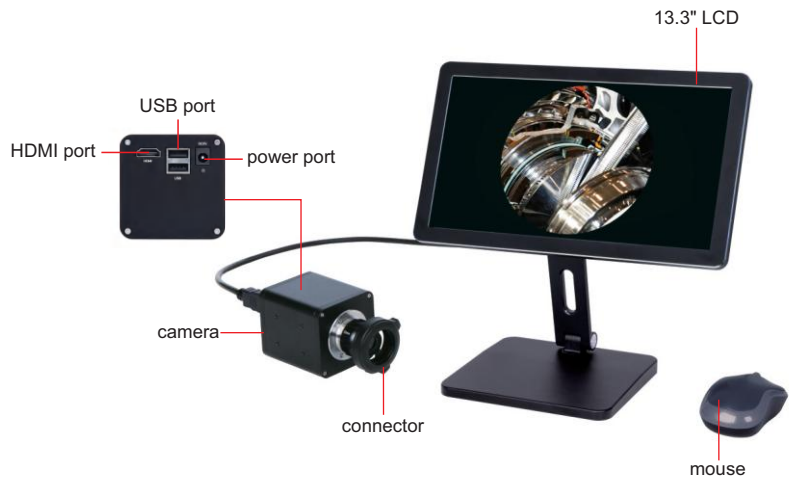

25

- For rigid borescopes
- 1080P high-definition image
- Auto-focus camera
- Take pictures and videos, saved to USB flash disk
- Automatic white balance and exposure
- Brightness, contrast ratio, gain are adjustable

SPECIFICATION

Sensor	1/2.8" CMOS
Pixel	2M
Resolution	1920×1080
Frame rate	60fps
Output	HDMI
Power supply	power adapter
Dimension (L×W×H)	350×100×430mm
Weight	2kg

STANDARD DELIVERY

Camera	1 pc
Connector	1 pc
13.3" LCD (with stand)	1 pc
16G USB flash disk	1 pc
Mouse	1 pc
HDMI cable	1 pc
Power adapter	2 pcs



16G USB flash disk (included)

ADJUSTABLE LED LIGHT SOURCE CODE ISV-1LED1



- For rigid borescopes
- High LED illumination and brightness is adjustable
- For long time work with low noise

SPECIFICATION

Color temperature	5600K
Cooling	fan cooling
Power supply	AC110~220V, 50/60Hz
Dimension	400×300×112mm
Weight	7kg

STANDARD DELIVERY

Main unit	1 pc
1.8m optical fiber cable	1 pc

CUSTOMIZED ACCORDING
TO WORKPIECES



FIXTURE FOR RIGID BORESCOPES CODE ISV-H□□□

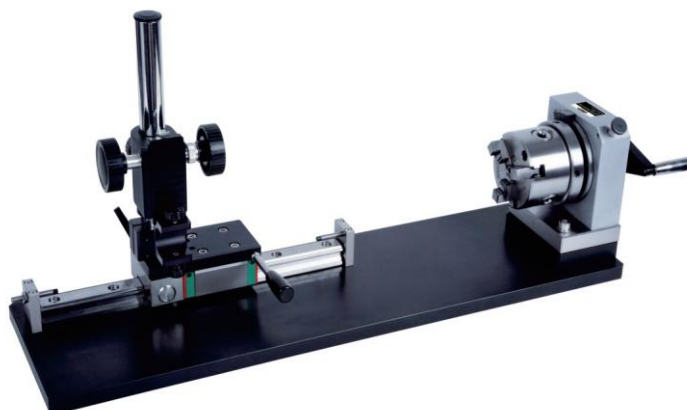

- Rotation by handle
- Move borescope along sliding rail
- For viewing the inside of workpieces
- Can be customized according to workpieces

SPECIFICATION

Max. clamping diameter of chuck	Ø68mm
Max. length of workpieces	384mm
Dimension (L×W×H)	650×180×297mm

application

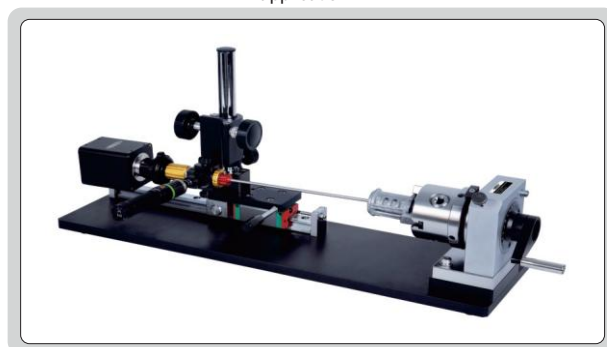



Air Leakage Testers
Page 794



Air Gauges And Displays
Page 795-798



Digital Gap Gauges
Page 799-800



Laser Scan Micrometers
Page 801-806



Length Measuring Machines
Page 807-808



Total Stations
Page 809



Industrial Acoustic Imagers
Page 810



**Automatic Cleanliness
Analysis Systems**
Page 811-812



**Automatic Vision
Inspection Machines**
Page 813-814



**Three-Dimension Full-field
Strain Measurement Systems**
Page 815



**Large Field Of View Dynamic
Measurement Systems**
Page 816

AIR LEAKAGE TESTER CODE ALT-P150

DATA
OUTPUT



pressure adjustment



gas inlet

gas pressure
regulator

test port

- Smart operation system with touch screen, operation UI based on testing procedure
- High sensitivity pressure sensor and adjustment unit with software algorithm ensure high accuracy and stability
- Test pressure range: -100kPa~1000kPa, positive and negative pressure mode with 8 basic test mode
- Up to 100 groups of subprogram, each can be edited separately, for individual or combination testing
- Built-in communication interface, MODBUS and TCP/IP communication protocol supported
- Pressure curve screenshot and history data can export to flash disk
- Accessories such as testing tooling and fixture, inflatable bypass, fast connector, standard leak can be customized for different products; optional electronic regulator enables multiple sets of pressure sequence testing
- Language: English, Chinese



standard leak (optional)



quick connector (optional)



scanner (optional)



tooling and fixture (optional)

SPECIFICATION

Device type	direct pressure
Channel	single-channel (customizable dual-channel)
Pressure mode	positive and negative pressure
Range	-60kPa~150kPa
Resolution	0.1Pa
Accuracy	±0.2%FS
Pressure unit	kPa, Pa, kgf/cm ² , psi, mmH ₂ O, bar, mbar, mmHg
Flow unit	SCCM
Test medium	compressed air or specified gas, 0.4MPa~0.8MPa
Tube caliber	gas inlet: Ø8mm, test port: Ø4mm
Pressure regulation	mechanical pressure regulator
Interface	USB, RS232, 25 PIN I/O interface, RJ45 (optional)
Operation environment	temperature: 0°C~50°C, humidity: ≤95%RH, no condensation
Power supply	AC 220V, 50Hz
Dimension (L×W×H)	340×225×187mm
Weight	7.3kg

* Available range: -80kPa~0kPa, -80kPa~600kPa, 0Pa~200kPa, 10kPa~700kPa; other ranges customizable

STANDARD DELIVERY

Main unit	1 pc
Gas pressure regulator	1 pc

OPTIONAL ACCESSORY

Software	ALT-P150-SW
Scanner (with scan software)	ALT-P150-SC
Standard leak	
Quick connector	customizable
Tooling and fixture	

**AIR GAUGES
CODE 9401**

CUSTOM-MADE

air plug gauges and standard rings



air ring gauges and standard plain plug gauges



air snap gauges and standard gauges



air taper gauges and standard gauges



air outside diameter measuring stages and standard gauges



air inside diameter measuring stages and standard rings



air angle gauges and standard gauges

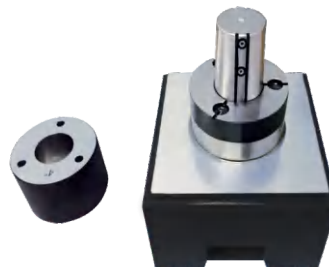



AIR GAUGE DISPLAYS (BASIC TYPE)

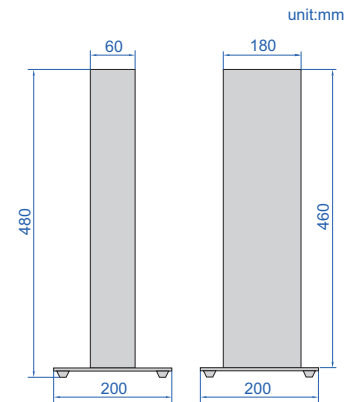
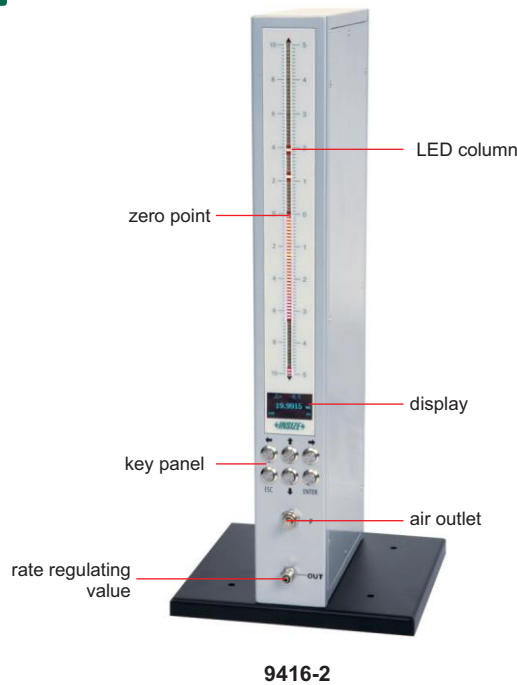
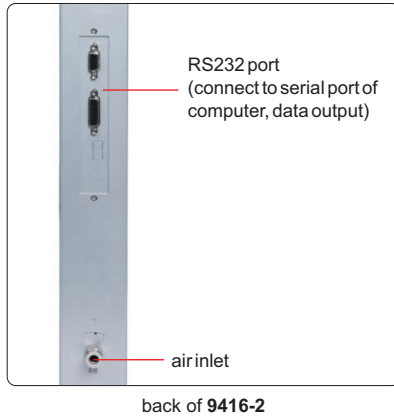

- Can store 9 measuring programs, and the programs can be switched quickly
- Data storage function, 99 groups data can be stored

SPECIFICATION

Code	9416-1 (without data output)	9416-2 (with data output)		
LED quantity	101 pcs			
LED color	red, orange, green			
LED height	254mm			
Range, resolution and accuracy	range	resolution		accuracy
		LED	display	
	10 μ m	0.1 μ m	0.1 μ m	0.2 μ m
	20 μ m	0.2 μ m	0.1 μ m	0.4 μ m
50 μ m	0.5 μ m	0.5 μ m	1 μ m	
100 μ m	1 μ m	0.5 μ m	2 μ m	
Unit	mm, μ m			
Air supply	dry and clean, 0.4~0.8MPa			
Data interface	/	RS232		
Operation temperature	-20~45°C			
Power supply	220V, 50Hz			
Dimension (L×W×H)	200×200×480mm			
Weight	3kg			



air filter (optional)



pressure regulating valve (optional)



RS232 cable (optional)



foot switch (optional)
(for data transmission)

STANDARD DELIVERY

Main unit	1 pc
-----------	------

OPTIONAL ACCESSORY

Air filter	9401-FILTER-A
Pressure regulating valve	9404-PRV
RS232 cable	9416-CB
Foot switch	9416-FS (requires pre-shipment installation)
Data output cable (keyboard format)	7302-9416

AIR GAUGE DISPLAY CODE 9408-QD100



DATA
OUTPUT

- Can store 10 measuring programs, and the programs can be switched quickly
- Data storage and query function

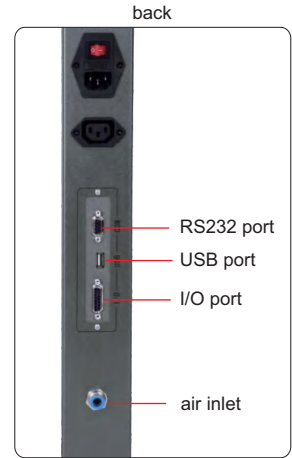
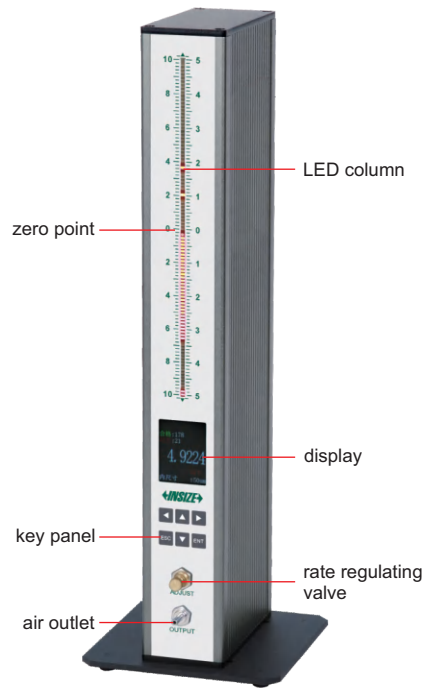

SPECIFICATION

LED quantity	101 pcs			
LED color	red, orange, green			
LED height	254mm			
Range, resolution and accuracy	range (μm)	resolution(μm)		accuracy (μm)
		LED	display	
	10	0.1	0.1	0.2
	20	0.2	0.1	0.4
	50	0.5	0.1	1
	100	1	0.2	3
Unit	mm, inch			
Air supply	dry and clean, 0.4~0.7MPa			
Data interface	RS232, USB			
Operation temperature	temperature	0~45°C		
	humidity	≤85%		
Power supply	AC185~265V, 50/60Hz			
Dimension (L×W×H)	160×160×490mm			
Weight	2.8kg			

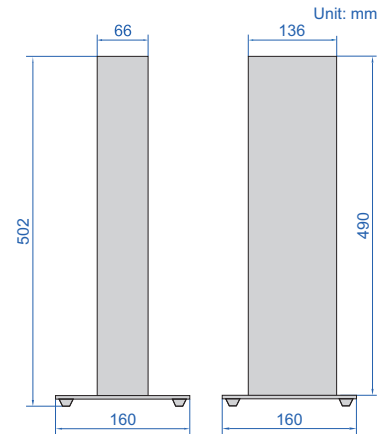

26

STANDARD DELIVERY

Main unit	1 pc
-----------	------

OPTIONAL ACCESSORY

RS232 cable	9408-CB
Foot switch	9408-FS (must be installed in factory)
Data output cable (keyboard format)	7302-9408
Wireless transmitter (receiver is needed)	7315-9408
Air filter	9401-FILTER-A
Pressure regulating valve	9404-PRV



foot switch (optional)



RS232 cable (optional)



pressure regulating valve (optional)



air filter (optional)



TOUCH
SCREEN

MULTI CHANNEL AIR GAUGE DISPLAYS

- Data storage function, 2 million groups data can be stored
- Can store 10 groups measuring programs, and the program can be switched quickly
- Insert USB flash disk to output storage data, update program
- Data can be shared or networked via TCP/IP (customized)
- With data statistics and analysis functions, can display graphs and Xbar-R control charts



9440-DP4

back of display

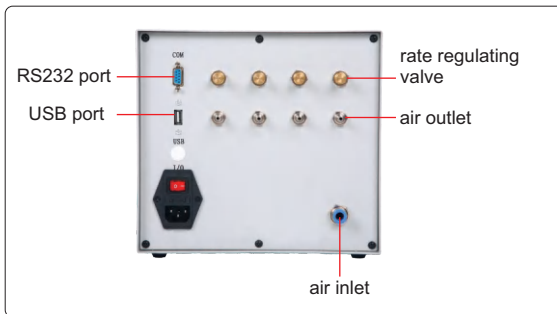

air filter (optional)



RS232 cable (optional)



foot switch (optional)



SPECIFICATION

Code	9440-DP1	9440-DP2	9440-DP3	9440-DP4	9440-DP5	9440-DP6	9440-DP7	9440-DP8
Number of channels	1	2	3	4	5	6	7	8
Display screen	7" TFT LCD touch screen display				10" TFT LCD touch screen display			
Display mode	graphic display, digital display							
Range	10 μ m, 20 μ m, 50 μ m, 100 μ m (adjustable)							
Accuracy	0.2 μ m (range 10 μ m)							
	0.4 μ m (range 20 μ m)							
	1 μ m (range 50 μ m)							
	3 μ m (range 100 μ m)							
Resolution	0.1 μ m							
Unit	mm							
Air supply	dry and clean, 0.4~0.7MPa							
Data interface	RS232/USB*							
Operation temperature	-10~55°C							
Power supply	220V, 50/60Hz							
Dimension (L×W×H)	240×230×230mm				320×145×325mm			
Weight	5.6kg				11.2kg			

* RS485 port, I/O port, ethernet communication port can be customized according to customer requirements

STANDARD DELIVERY

Main unit	1 pc
-----------	------

OPTIONAL ACCESSORY

Air filter	9401-FILTER-A
Foot switch	9440-FS
RS232 cable	9440-CB
Data output cable (keyboard format)	7302-9440

DIGITAL GAP GAUGE

INSIZE PLUS
MADE IN EUROPE

DATA
OUTPUT



CUSTOMIZABLE PROBES
MEASURING RANGE: 0.35-6mm
MEASURING DEPTH: 2-500mm

TITANIUM AND SYNTHETIC DIAMOND
COATED PROBES ARE OPTIONAL

- Real-time measurement: display maximum value, minimum value current measurement value and measurement curve
- Group measurement: target value and upper and lower tolerance can be set, automatic judgement of OK and NG



probe (optional) handle

data acquisition button

measurement principle

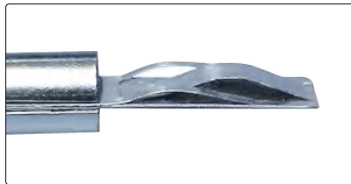

the deformation of the probe results in the output of an analogue signal, which is then used by the software to calculate the dimensional value

ISE-DF10

application

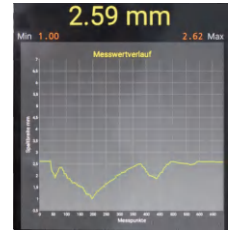
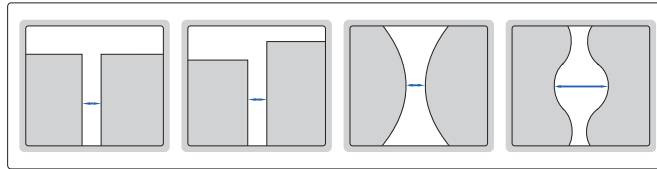

real-time measurement



measuring car body seam



measuring gaps on the car dashboard

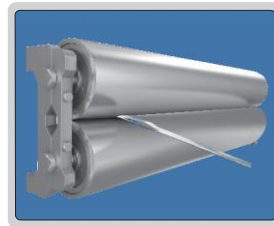

measuring roll gap



measuring blade to sidewall gap

26



titanium plated probe
(optional)



synthetic diamond coated probe
(optional)

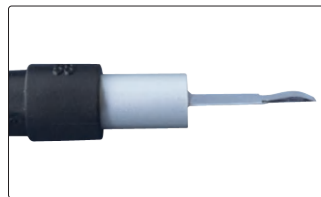

single-side probe
(optional)

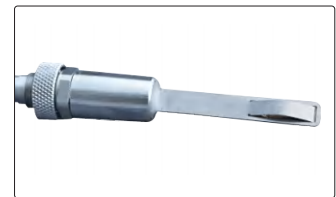

bilateral probe
(optional)

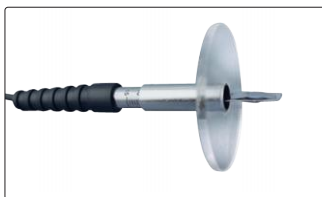

depth positioning probe
(optional)

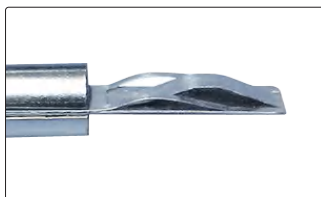

single-side probe
(optional)

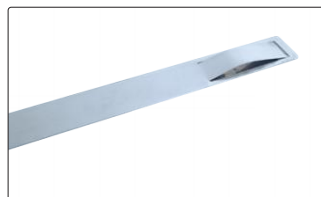

bilateral probe
(optional)



bilateral probe
(optional)

To be continued

Continued from previous page



bilateral long depth probe
(optional)



single-side hockey stick shaped probe
(optional)

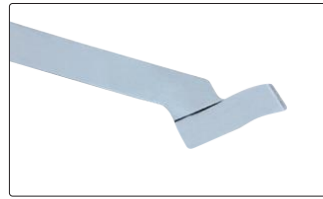

single-side hockey stick shaped probe
(optional)



90° probe
(optional)



single-side positioning probe
(optional)



single-side probe
(optional)



single-side positioning probe
(optional)

PC software (optional)
connect the probe without main unit, export CSV or PDF file

scheduled measurement mode
set the tolerance and judge OK or NG

real-time
measurement mode

average value
measurement mode

maximum
measurement mode

minimum
measurement mode

display of
measurement curve

SPECIFICATION OF MAIN UNIT

Code	ISE-DF10
Resolution	0.1/0.01/0.001mm adjustable
RAM	8GB
Output	USB, WIFI
Output format	XML, CSV

OPTIONAL ACCESSORY

PC software	ISE-DF10-SOFTWARE
Probe	customized to customer requirements

SPECIFICATION OF PROBES (OPTIONAL)

Customizable measuring range	0.35-6mm
Effective range	±0.5mm
Accuracy	range: 0.35~2.0mm, accuracy: ±0.03mm range: 0.35~6.0mm, accuracy: ±0.04mm
Max. customizable length	500mm
Repeatability	0.02mm
Measuring force	<3.5N
Measuring time	<1s

LASER SCAN MICROMETERS

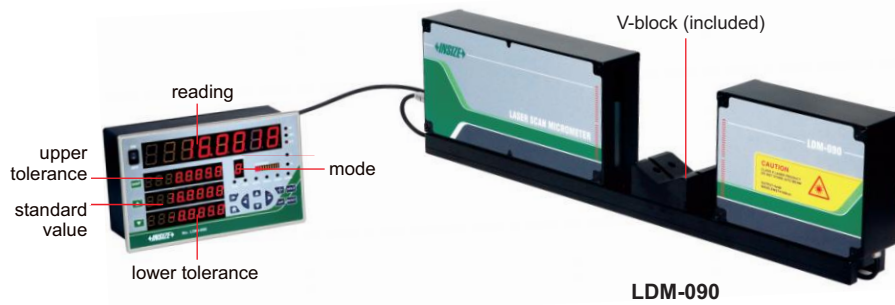
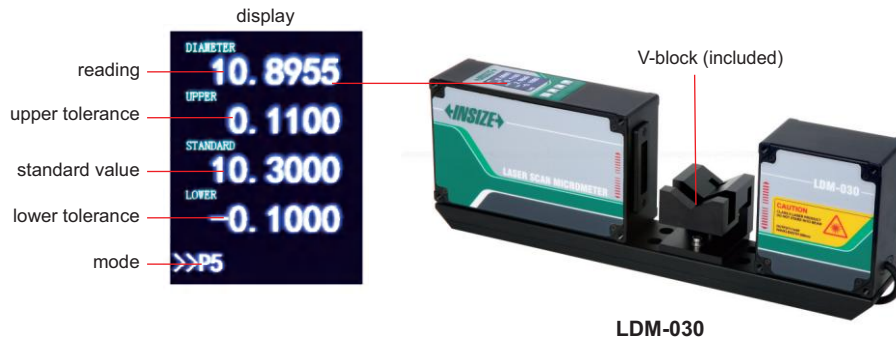

- Measure outer diameter, ellipticity, run-out, maximum diameter of tools, etc.
- Can be used for transparent or non transparent workpieces
- Tolerance measurement
- Online or offline measurement
- Connected with computer, PLC, control box

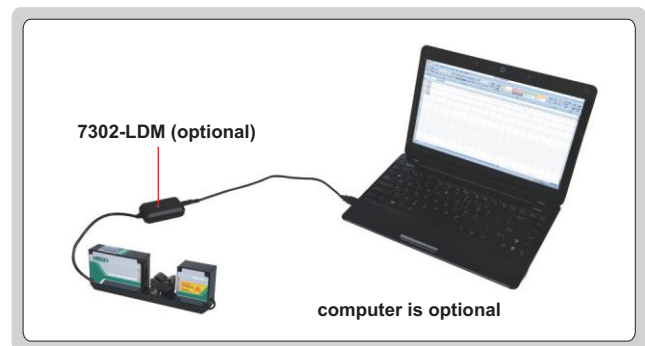

keyboard signal, can be transmitted to Excel

Dimension	(mm)		
Code	LDM-030	LDM-065	LDM-090
L	351	469	608
W	52	52	60
H	120	146	162
L1	170	203	278
L2	95	131	178

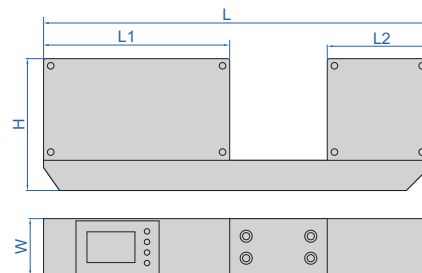

To be continued

Continued from previous page

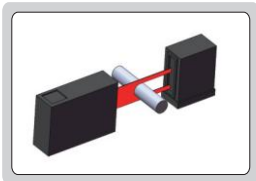

measure external diameter

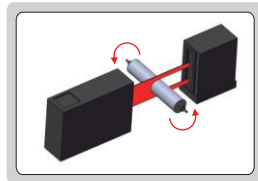

measure ellipticity and run-out

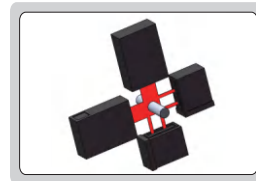

two-axis measurement

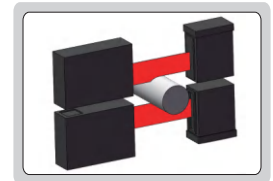

large size measurement

SPECIFICATION

Code	LDM-030	LDM-065	LDM-090
Measuring range	0.1~30mm	0.5~65mm	1~85mm
Resolution	0.01/0.1/1/10/100μm selectable		
Accuracy (25°C in laboratory)	±(0.5+10%D)μm, D is measuring diameter in mm		±6μm
Repeatability (25°C in laboratory)	(0.3+5%D)μm, D is measuring diameter in mm		3μm
Laser wave length	650nm		
Measuring speed	800~3200times/s (adjustable)		
Operation temperature	0~50°C		
Operation humidity	35~85RH without condensation		
Output	dual channel RS485		
Alarm output	24V, 1A		
Power supply	DC24V, 2A		
Dimension (L×W×H)	351×52×120mm	469×52×146mm	608×60×162mm
Weight	5kg	8kg	10kg



connect to control box (optional)



calibration gauge (optional)

STANDARD DELIVERY

Main unit	1 pc
V-block	1 pc
AC/DC adapter	1 pc
RS485 cable	1 pc

OPTIONAL ACCESSORY

Data output cable (keyboard format)	7302-LDM page 22
Calibration gauge	custom made
Control box	custom made

LASER SCAN MICROMETER (BASIC TYPE) CODE LDM-D090



calibration gauge (optional)

- Can measure the width and thickness of flat cables and tapes
- Can measure the outer diameter of cables, pipes and wires
- Laser scanning technology, large measurement range, high accuracy, high repeatability
- Connected with PLC and PC with RS485 interface
- Use high-precision F (θ) mirror, the swing of the measured object does not affect the measurement

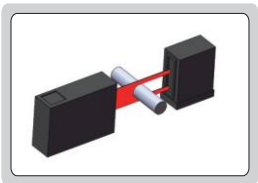

measure external diameter

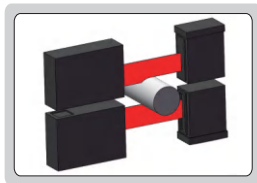

large size measurement

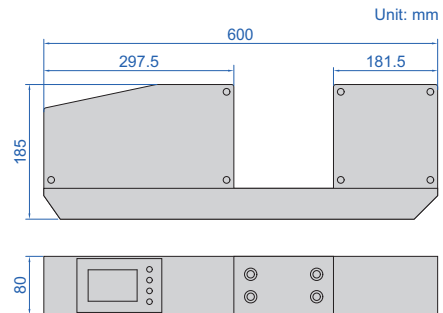

SPECIFICATION

Measuring range	0.5~90mm
Resolution	1μm
25°C accuracy	±(5+20%D)μm, D is measuring diameter in mm
Repeatability	(3+20%D)μm, D is measuring diameter in mm
Laser wave length	650nm
Measuring speed	600 times/s
Operation temperature	5~45°C
Operation humidity	≤80%RH without condensation
Output	RS485/MODBUS protocol
Alarm output	24V, 1A
Power supply	AC85V~220V (50~60Hz)
Dimension (L×W×H)	600×80×185mm
Weight	6.5kg

STANDARD DELIVERY

Main unit	1 pc
V-block	1 pc
AC/DC adapter	1 pc
RS485 cable	1 pc

OPTIONAL ACCESSORY

Calibration gauge	custom made
-------------------	-------------



CUSTOMIZED ACCORDING TO WORKPIECES

AUTOMATIC LASER SCAN MICROMETER CODE LDM-AT01



center-type bench center (included)



V-type bench center (included)



clamping workpieces by V-type bench center



clamping workpieces by center-type bench center

- Motorised rotation with adjustable speed
- Auto-moving laser scan micrometer
- Measure the outer diameter, roundness and runout of workpieces at multiple sections

SPECIFICATION

Workpiece clamping mode		center-type bench center (with centre holes at the end)	V-type bench center (without centre holes at the end)
Measuring range of workpieces	length	5~300mm	10~230mm
	diameter	3~60mm	10~60mm
	max. weight	20kg	1.5kg
Accuracy at 25°C		$\pm(0.5+10\%D)\mu\text{m}$, D is measuring diameter in mm	
Repeatability at 25°C		$(0.3+5\%D)\mu\text{m}$, D is measuring diameter in mm	
Runout accuracy at 25°C		$\leq 5\mu\text{m}$	
Size of working table		400×200mm	
Driving method		motor drive	
Power supply		220V, 50/60Hz	
Dimension		750×600×900mm	
Weight		50kg	

STANDARD DELIVERY

Main unit	1 pc
Center-type bench center	1 pc
V-type bench center	1 pc

To be continued

Continued from previous page

MEASURING SOFTWARE (INCLUDED)

- Language: English and Chinese
- Operation system: Windows 7
- Measure the outer diameter, roundness and runout of workpieces automatically, then the data, trend graphs and judgement results can be displayed in real time
- Auto-saving measurement data, query and export to EXCEL at any time
- Switch to manual test to move the laser scan micrometer and rotate the motor by hand

main interface

The main interface is divided into several functional areas:

- test parameters:** A panel on the left containing fields for Recipe ID (Recipe01), Design diameter (20 mm), Upper/Lower limits, Circularity (5 mm), Runout (0.002 mm), Number of positions (3), and enable/disable checkboxes for Circularity and Runout.
- trend graph:** A central chart showing measurement trends for Diameter, Circularity, and Runout over time.
- button:** An 'Operation Control' panel on the right with buttons for Start, Stop, Home, and AlarmClr.
- measuring position (arbitrary setting):** A field in the 'Production Data' section for setting the measurement position.
- judgement result:** A large 'OK' indicator at the bottom left.
- measurement data:** A table at the bottom displaying a list of measurements with columns for ID, Position, Diameter, Circularity, Runout, and Date.

ID	Position	Diameter	Circularity	Runout	Date
1	1.942	19.81	0.0005	0.0026	2024-04-01 09:59:15
2	14.926	19.8104	0.0006	0.0035	2024-04-01 09:59:24
3	29.896	19.8099	0.0012	0.0028	2024-04-01 09:59:34
4	44.913	24.9361	0.0013	0.0502	2024-04-01 09:59:43
5	49.901	24.9364	0.0019	0.0491	2024-04-01 09:59:52
6	54.917	24.9369	0.0016	0.0459	2024-04-01 10:00:01
7	69.943	19.814	0.0014	0.0033	2024-04-01 10:00:11

manual test

The manual test interface features two primary control sections:

- move laser scan micrometer:** A section with 'X Current POS' (0.000 mm) and 'Grating ruler POS' (0.000 mm) fields, along with JOG+ and JOG- buttons.
- rotate motor:** A section with 'R Current Pos' (0) and a rotation direction selector, along with JOG+ and JOG- buttons.

history data

The history data interface displays a table of measurement records with the following columns: ID, File Base, Position mm, Diameter mm, Circularity mm, Runout mm, and Date. The table contains 15 rows of data.

ID	File Base	Position mm	Diameter mm	Circularity mm	Runout mm	Date	
1	II20240422092921	A01	5	15.1105	0.0014	0.0061	2024-04-22 09:29:40
2	II20240422092921	A01	20	25.1102	0.0021	0.0084	2024-04-22 09:29:49
3	II20240422092921	A01	50	25.0979	0.0011	0.0056	2024-04-22 09:30:00
4	II20240422092921	A01	80	25.0994	0.0016	0.0059	2024-04-22 09:30:11
5	II20240422092921	A01	150	25.0999	0.0012	0.0046	2024-04-22 09:30:23
6	II20240422111429	A02	10	19.9977	0.0011	0.0046	2024-04-22 11:14:38
7	II20240422111429	A02	20	19.9973	0.0023	0.0043	2024-04-22 11:14:47
8	II20240422111429	A02	40	19.9966	0.002	0.0036	2024-04-22 11:14:57
9	II20240422111429	A02	60	19.9959	0.0044	0.0036	2024-04-22 11:15:07
10	II20240422111429	A02	100	19.9946	0.003	0.0024	2024-04-22 11:15:18
11	II20240422111536	A02	10	19.998	0.0012	0.0048	2024-04-22 11:15:45
12	II20240422111536	A02	20	19.9974	0.0029	0.0043	2024-04-22 11:15:55
13	II20240422111536	A02	40	19.9963	0.0012	0.0037	2024-04-22 11:16:05
14	II20240422111536	A02	60	19.9964	0.0046	0.0049	2024-04-22 11:16:15
15	II20240422111536	A02	100	19.9946	0.003	0.0037	2024-04-22 11:16:25



VIDEO

application

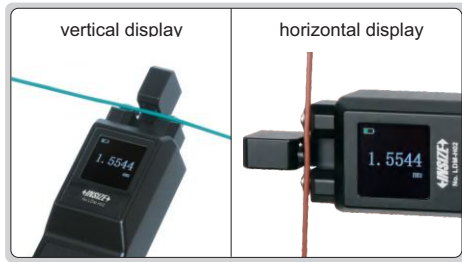

calibration gauge
(included)



- Measure the outside diameter of cables, pipes and wires
- For transparent or non transparent workpieces
- Unit: mm, inch, mil, μm
- Compact and portable, the reading can be displayed vertically or horizontally

SPECIFICATION

Measuring range	0.02~2mm
Resolution	0.001mm/0.0001mm/0.00001mm adjustable
Accuracy (at 25°C)	$\pm 0.5\mu\text{m}$
Repeatability (at 25°C)	0.3 μm
Laser wave length	650nm
Measuring speed	800 times/s
Operation temperature	0~50°C
Operation humidity	35~85%RH without condensation
Power supply	built-in 7.4V rechargeable battery
Weight	495g

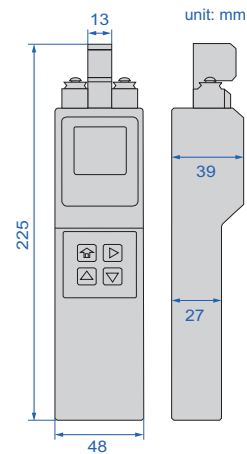

STANDARD DELIVERY

Main unit	1 pc
Calibration gauge	3 pcs (0.10 \pm 0.001mm, 0.30 \pm 0.001mm, 0.80 \pm 0.001mm)
AC/DC adapter	1 pc

CUSTOMIZED
TO WORKPIECES



VIDEO

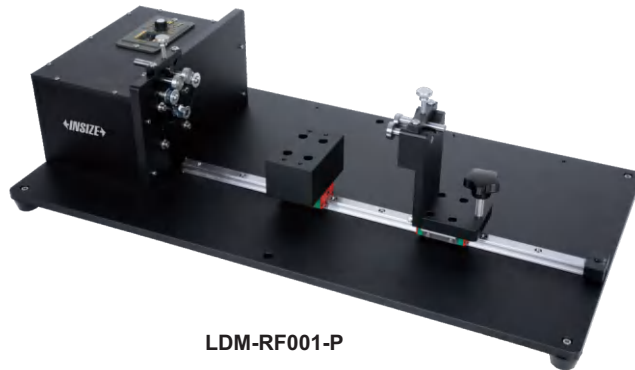

LDM-RF001-P

- Motorised rotation with adjustable speed
- Move laser scan micrometer by hand
- Measurement of the outer diameter and runout of workpieces at multiple sections
- Can be customized to the workpieces

SPECIFICATION

Code		LDM-RF001-P	LDM-RF001-K	LDM-RF001-B
Measuring range	diameter	Ø3~25mm		
	length	50~350mm		
Runout accuracy		2 μm		
Power supply		AC 220V, 50/60Hz		
Power cord		European type	British type	Brazilian type
Dimension		680×360×200mm		

OPTIONAL ACCESSORY

Customized fixture	customized according to customer workpieces
--------------------	---

FIXTURE FOR LASER SCAN MICROMETERS

application

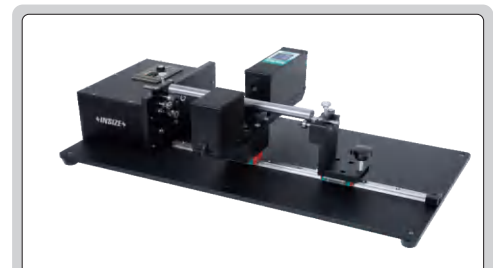

customized fixture
(optional)

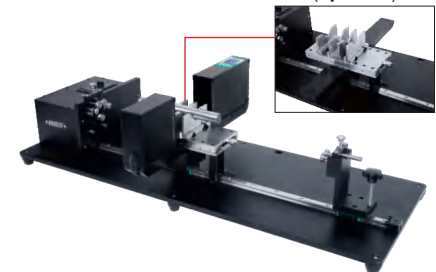

customized fixtures are available for special shapes of workpieces, such as stepped shapes

LENGTH MEASURING MACHINES

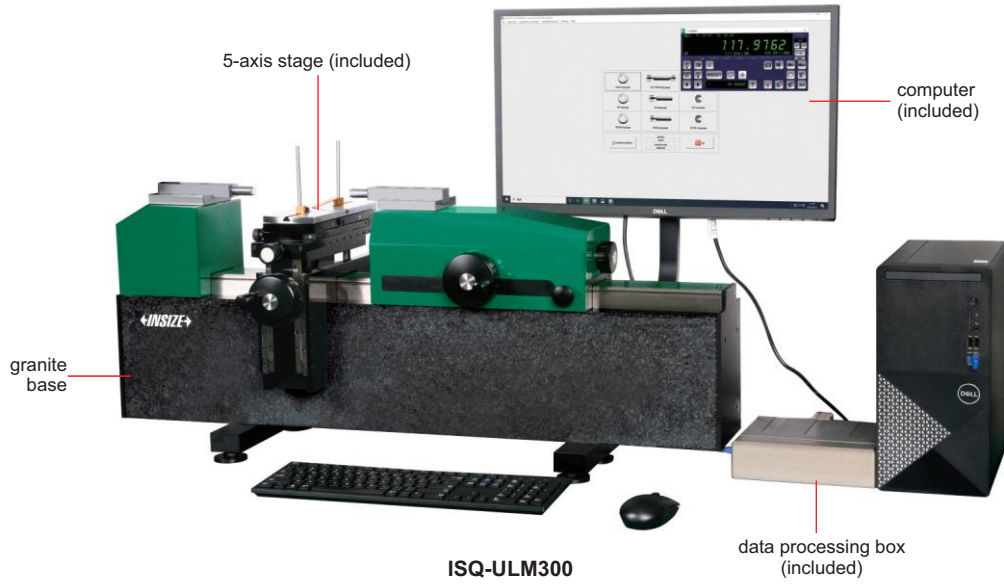

ISQ-ULM300

- High quality granite base ensures measurement stability and rigidity
- Measuring workpieces do not require pre-calibration with gauge blocks, and there is no transmission error
- The measuring force can be continuously adjusted
- Full range absolute measurement with high measurement efficiency
- The coaxiality of the anvils is extremely high, eliminating the need for repeated alignment
- 5-axis table can be moved freely in the direction of the guideway, locking

ring gauge measurement

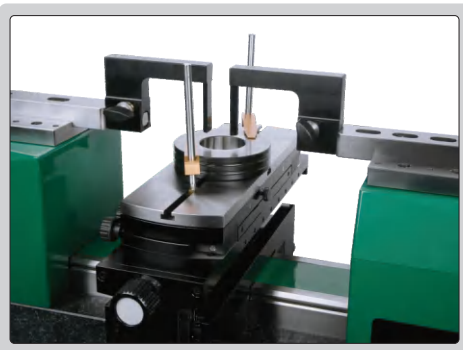

thread ring gauge measurement

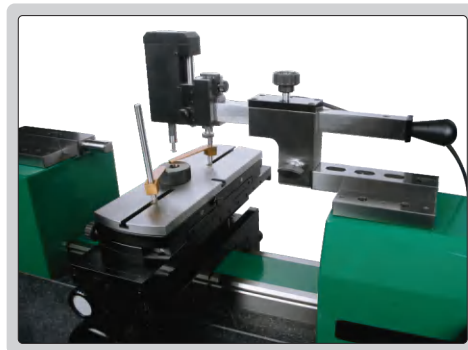

plug gauge measurement

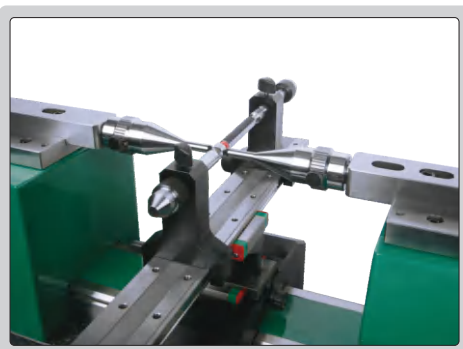

pin gauge measurement



To be continued



Continued from previous page

SPECIFICATION

Code		ISQ-ULM300	ISQ-ULM500	ISQ-ULM1000	ISQ-ULM1500	ISQ-ULM2000	ISQ-ULM3000
Range	outside dimension	0~300mm	0~500mm	0~1000mm	0~1500mm	0~2000mm	0~3000mm
	inside dimension	1~180mm	1~380mm	1~880mm	1~1380mm	1~1880mm	1~2880mm
Grating scale length		330mm	530mm	1030mm	1530mm	2030mm	3030mm
Resolution		0.01μm					
Accuracy		(0.15+L/1000)μm, (L is the measuring length in mm)			(0.25+L/1000)μm, (L is the measuring length in mm)		
Repeatability		outside dimension: <0.2μm, inside dimension: <0.1μm					
Measuring force		0~12N, continuously adjustable					
Environmental requirement	temperature	19°C~21°C					
	humidity	40%~70%					
Calibration requirements		calibration temperature: 20°C±0.5°C, temperature change: ≤0.5°C/h; humidity: 50%±5%					
Power supply		220V, 50/60Hz					
Dimension (L×W×H)		982×290 ×425mm	1147×290 ×425mm	1647×290 ×425mm	2147×290 ×425mm	2737×290 ×425mm	3740×290 ×425mm
Weight		130kg	180kg	260kg	310kg	620kg	920kg

STANDARD DELIVERY

Main unit	1 pc
Computer	1 pc
Software	1 pc
Spring finger	1 pc
5-axis stage (Max. load 12kg)	1 pc
Flat probes	2 pcs
Temperature compensation system	1 pc

OPTIONAL ACCESSORY

Micrometer rod calibration measuring device	adjustable vertical bracket	ISQ-ULM300-DM-1	1 pc
	V-bracket	ISQ-ULM300-DM-2	2 pcs
Plain ring gauge measuring device	electronic measuring arm	ISQ-ULM300-SR-1	1 set
	single ball head set (probes 0.1/1.0/2.5/5mm)	ISQ-ULM300-SR-2	1 set
	40mm ring gauge	ISQ-ULM300-SR-3	1 pc
	dual hook probes	ISQ-ULM300-SR-4	2 pcs
Thread ring gauge measuring device	electronic measuring arm	ISQ-ULM300-SR-1	1 set
	T-probe set (probes 0.455/0.53/0.62/0.725/0.895/1.1/1.35/1.65/2.05/2.55/3.2/4.0mm)	ISQ-ULM300-TR-2	1 set
Plain plug gauge measuring device	plug gauge measuring stage	ISQ-ULM300-SP-1	1 pc
	knife edge probes	ISQ-ULM300-SP-2	2 pcs
Thread plug gauge measuring device	3-wire set (∅0.170/0.195/0.220/0.250/0.290/0.335/0.390/0.455/0.530/0.620/0.725/0.895/1.100/1.350/1.650/2.050/2.550/3.200mm)	ISQ-ULM300-TP-2	1 set
Gauge block measuring device	airey point bracket (100-300)mm	ISQ-ULM300-BM	1 pc
	10mm ball probe	ISQ-ULM300-FP	2 pcs
	airey point bracket (100-500)mm	ISQ-ULM500-BM	1 pc
	10mm ball probe	ISQ-ULM300-FP	2 pcs
	airey point bracket (100-1000)mm	ISQ-ULM1000-BM	1 pc
	10mm ball probe	ISQ-ULM300-FP	2 pcs
OFFICE software	7313-OFFICE		1 set
5-axis stage (Max. load 40kg)	ISQ-ULM300-FT		1 pc
Ring gauge holder (for ring gauges >100mm)	ISQ-ULM300-RG		1 pc

Other measuring devices shall be consulted according to the requirements of specific measuring tools

TOTAL STATION (BASIC TYPE) CODE TSA-B33

measuring tape (included)



USB flash drive (included)



- With rear intersection, setting out, overhang measurement, eccentricity measurement and other functions
- Widely used in surveying and mapping engineering, construction engineering and many other precise measurement fields
- Safe class 3R laser rangefinder with prism-free range up to 1500m
- Absolute coded goniometric technology, horizontal and vertical discs are easy to measure with a counterpoise probe
- Biaxial liquid photoelectric electronic compensator automatically corrects instrument leveling errors
- Built-in temperature and air pressure sensor automatically corrects distance measurement errors
- Can revise prism constant



IP55
WATERPROOF

DATA
OUTPUT

SPECIFICATION

Distance measurement (With cooperation target)	measuring range	prism: 5000m reflective patch (60mm×60mm): 1000m
	accuracy	$\pm(2+D/500)$ mm, D: measured distance, unit: m
	measuring time	continuous measurement: 0.25s, tracking measurement: 0.1s, single measurement: <1.0s
Prism-free distance measurement (Without cooperation target)	measuring range	1500m (Kodak Grey, 90% reflectivity)*
	accuracy	0-300m: $\pm(3+D/500)$ mm 300-600m: $\pm(5+D/500)$ mm >600m: $\pm(10+D/500)$ mm, D: measured distance, unit: m
	measuring time	continuous measurement: 0.25s tracking measurement: 0.1s single measurement: <1.0s
Angle accuracy		$\pm 2''$
Minimum angular reading		0.1"/1" (selectable)
Telescope barrel length		152mm
Telescope magnification		30X
Field of view		1°30"
Frame rate		3"
Minimum focus distance		1.5m
Compensator		range: $\pm 6'$, accuracy: $\pm 1''$
Tube level bubble		30"/2mm
Round level bubble		8"/2mm
Display	screen type	240×160 dot matrix high definition high brightness display
	screen size	3.1 inch
	digital display	maximum: 99999999.9999m minimum: 0.1mm
Data transmission		USB flash drive, bluetooth
Power supply		7.4V replaceable battery for 8 hours of continuous operation
Dimension (L×W×H)		206×180×353mm
Weight		5.4kg

* Good weather: overcast sky, light wind, no fog, visibility about 40km

STANDARD DELIVERY

Main unit	1 pc
Tripod	1 pc
Power adapter and charging cable	1 set
Li-ion battery	2 pcs
USB flash drive	1 pc
Measuring tape	1 pc

OPTIONAL ACCESSORY

Single prism	TSA-B33-PR
Prism tripod	TSA-B33-PRT

single prism (optional)



tripod (included)



prism tripod (optional)





IP56
WATERPROOF

INDUSTRIAL ACOUSTIC IMAGER CODE SCX-DMM72



- Suitable for gas leakage detection under the pressure or vacuum conditions, equipment noise localization, partial discharge localization and other scenarios
- Partial discharge pattern display function: real-time display of pulse emission pattern
- Leakage assessment function: adjustable measuring distance, more accurate assessment of the leakage rate
- Intelligent noise reduction function: automatically filter sound signals outside the focus frame
- Adjustable decibel threshold function: used to filter background noise
- Support photo and video recording of fault location
- Language: Chinese, English

SPECIFICATION

Microphone array	microphone	132 channels MEMS microphone
	frequency band	2kHz~65kHz
	sound image field of view	62°×45°
	sound image frame rate	25FPS
	test sound pressure level range	30dB~120dB
	detect distance	0.5m~100m
Camera	position accuracy	±1cm
	camera focal length	3.04mm
Display screen	focusing mode	automatic
	resolution	1024×600
	size	10"
	touch screen	capacitive
Storage	backlight	adjustable
	data interface	TF memory card/USB 3.0/TYPER-C
	data storage format	.jpg (picture), .mp4 (video)
Power system	battery type	rechargeable lithium-ion battery, working time about 3.5h
	charging mode	TYPE-C charging; portable charger, capable of charging while using
Environment parameter	switch-on temperature	-10°C~40°C
	operation temperature	-25°C~50°C
	storage temperature	-20°C~40°C
	relative humidity	10%RH~95%RH (non-condensing)
Physical parameter	lamp	1w
	shell material	aluminium alloy, drop-proof design
	protection	IP56
	dimension	272mm×200mm×50mm
	weight	2.1kg (including handle and shoulder strap)

STANDARD DELIVERY

Main unit	1 pc
128G TF card	1 pc
Reader	1 pc
Power adapter	1 pc

PARTS CLEANLINESS TESTING CABINET CODE OPP-GZ01

CUSTOMIZABLE TESTING
CABINET SIZES

COMPLY WITH VDA19.1, ISO16232
STANDARDIZED TESTING PROCESS



- High-efficiency air filtration system on the top, effectively improving the reliability of environmental testing and eliminating cross-contamination
- 10" color touch screen operation, easy to operate, can store the test process, more automated
- An exhaust port is located at the top of the wash tank to remove aerosol emissions from the inspection process, improving product and user safety
- Three-layer membrane holder for three different membrane sizes

SPECIFICATION

Control panel	10" touch screen (can store cleaning programs)
Analysis area	304 stainless steel
Temperature monitoring	liquid temperature monitoring
Flushing pressure	0~6bar
Airbrush flow rate	0~6L/min
Flow setting range	0~999L
Control method	airbrush+footswitch control
System filter	multi-stage precision filtration system, accuracy 0.2μm
Hepa purification	high efficiency filtration precision 0.3μm, 99.995% filtration efficiency
Ultrasound	28kHz/40kHz
Cleaning tank size	700×600×800mm
Power supply	AC 220V, 50/60Hz, 1.5kW
Dimension (W×H×D)	1300×900×2000mm
Weight	350kg

STANDARD DELIVERY

Main unit	1 pc
Rack	1 pc
Membrane	1 box
Air filter	1 set
Cleaning cartridge	1 set
Maintenance tool	1 set
Power line	1 pc

OPTIONAL ACCESSORY

Perfusion module	OPP-GZ01-PERFUSION
Shaker	OPP-GZ01-SHAKERS
Heating module	OPP-GZ01-HEATING

COMPLIES WITH VDA19.1, ISO16232
STANDARDIZED TESTING PROCESS



computer and software
(included)



AUTOMATIC CLEANLINESS ANALYSIS SYSTEM CODE OPP-OM53



camera
(included)

filter membrane
fixture (included)

motorized scanning
table (included)

scanning image stitching

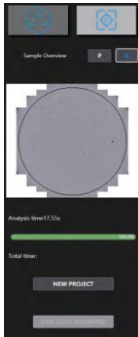

test result statistics

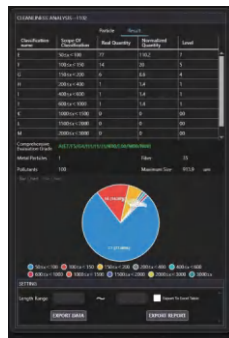

example of cleanliness report analysis

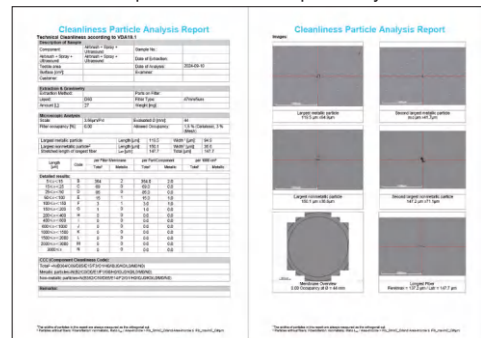

- High resolution metallographic optics
- Automatically detects and distinguishes particle types
- One scan, one click report
- High reliability, high accuracy
- Parameters such as length, width, area, maximum fiber length, total length, etc. can be evaluated

SPECIFICATION

Magnification	50X, 200X (customizable)
Detecting particle size	≥5µm (customizable 2µm)
Distinguish between particle types	metals, non-metals, fibers
Height detection	included
Polarized light	automatic adjustment
Light source control	automatic adjustment
Focus display	automatic adjustment, real-time display
Power supply	AC 220V, 50Hz
Overall dimensions (W×H×D)	1200×600×650mm
Weights	25kg

cleanliness analysis software (included)

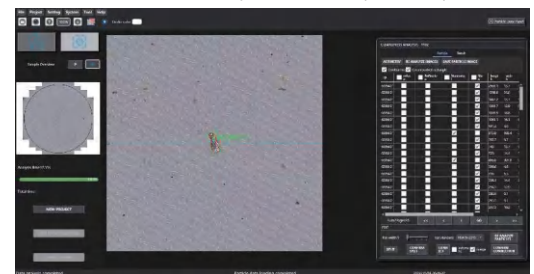

STANDARD DELIVERY

Microscope	1 pc
Analysis software	1 pc
Camera	1 pc
Computer	1 pc
Filter membrane fixture	1 pc
Motorized scanning station	1 pc
Calibration disk	1 pc

OPTIONAL ACCESSORY

Metallographic analysis software	ISM-MAS100C-SOFTWARE
Objective lens 10X	OPP-OM53-PLO10X
Objective lens 50X	OPP-OM53-PLO50X
Objective lens 100X	OPP-OM53-PLO100X

AUTOMATIC VISION INSPECTION MACHINE CODE AVIM

AUTOMATIC INSPECTION OF LARGE
QUANTITIES OF WORKPIECES

AUTOMATIC
SORTING

SIZES MEASUREMENT AND
DETECTION OF SURFACE DEFECTS

CUSTOM-MADE



- For testing fasteners, mobile phone parts, plastical products, electronic components and special-shaped hardware, etc.
- Can be equipped with laser, marking, automatic counting and packing, automatic feeding, eddy probe (detecting heat treatment)

SPECIFICATION

Diameter of workpiece	1-25mm
Height of workpiece	1-40mm
Sorting accuracy	±0.005~±0.02mm
Air pressure	5kg/cm ²
PC mainframe	industrial computer
Digital camera	8 sets of industrial cameras (to be determined according to the actual situation)
Weight	800kg
Dimension (L×W×H)	1500×1100×1800mm



INTERNAL STRUCTURE

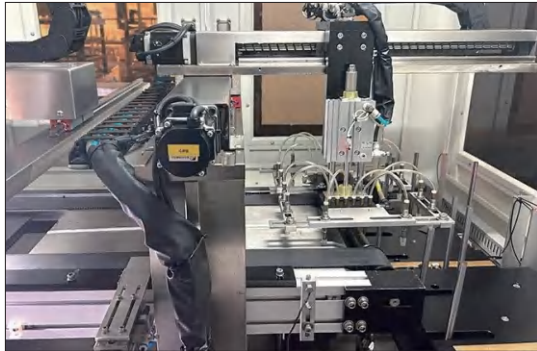

electrical system

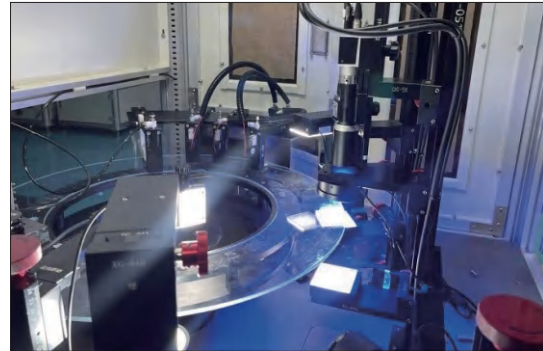

glass sorting plate

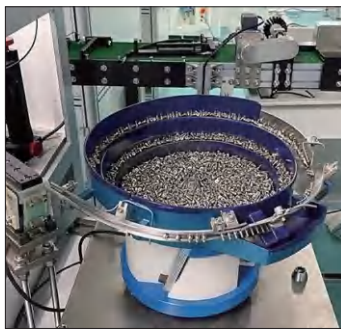

vibratory feeder loading

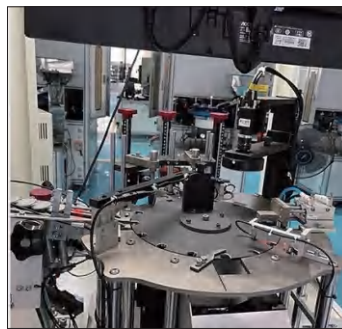

turntable structure



multiple cameras detection

To be continued

Continued from previous page

PARTS EXAMPLE

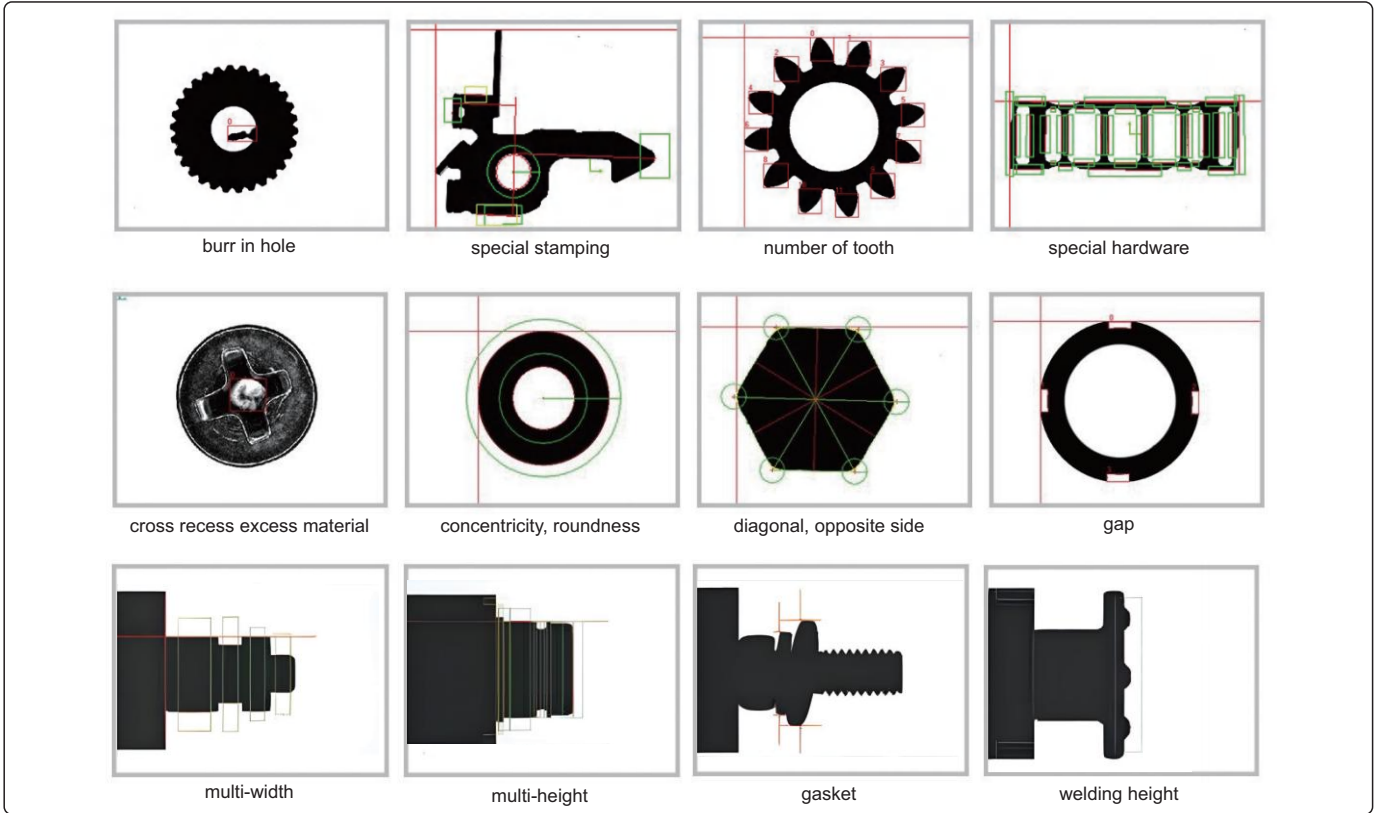

PRODUCT EXAMPLES



THREE-DIMENSION FULL-FIELD STRAIN MEASUREMENT SYSTEMS



SUBPIXEL MEASUREMENT ACCURACY

DISPLACEMENT/DEFORMATION AND MOTION ANALYSIS

MULTIPLE MEASUREMENTS

- Accurate calculation of 3D coordinates, 3D displacements and strains, velocities and accelerations, etc.
- By analyzing the measurement data, parameters of the mechanical properties, trajectory and deformation of the material are obtained
- Comprehensive range of measurement results, including single-point, multi-point, full-field data, 2D/3D data, images, tables, videos, curves, and customized data

Main application

- Testing of mechanical properties of materials and parts
- Structural strength and stiffness analysis
- Vibration analysis
- Collision test
- Complex 3D motion analysis
- High and low temperature expansion analysis
- Video Extensometer



ISD-TD1

Typical application

tensile testing of steel plates of automobiles		various drop tests	
test site	picture after breaking	test site	battery pack drop test strain field picture
cloud picture before breaking	cloud picture after breaking	mobile phone drop test strain field picture	mobile phone drop test strain field cloud picture

SPECIFICATION

Code	ISD-TD1	ISD-TD2	ISD-TD3
Pixel	5M	12M	25M
Frame rate	60fps	30fps	90fps
Strain accuracy	≤50με	≤20με	≤20με
Strain range	0.005%~2000%	0.002%~2000%	0.002%~2000%
View field	10mm~4m	10mm~10m	10mm~10m

* Can be customized according to actual scenarios (microscopic, high-speed, etc.)

STANDARD DELIVERY

Camera	2 pcs
Tripod	1 pc
Computer	1 pc
Three-dimension software	1 pc

OPTIONAL ACCESSORY

Video extensometer software	ISD-UTM-M
-----------------------------	-----------

SUBPIXEL MEASUREMENT ACCURACY

WIDE MEASURING RANGE

CUSTOM-MADE



LARGE FIELD OF VIEW DYNAMIC MEASUREMENT SYSTEM CODE ISD-LF



- A three-dimension dynamic system based on marking points of tracking, using close-range industrial photogrammetry and visual triangulation
- Measuring the trajectory, attitude and velocity accurately of the marking point in 3D space
- Analyzes data such as 3D coordinates, 3D motion deformation, 3D velocity and acceleration, 3D trajectory measurement, and 6-degree-of-freedom measurement
- Measurement results can be provided as images, tables, videos, curves, customized data, etc.
- Adaptable to high and low temperatures, high-speed shock, vibration and other environments
- Traceable testing process

SPECIFICATION

Pixel	5M~25M
View field	1m~200m
Real-time measurement speed	20Hz~500Hz
Accuracy	0.01%

* Customized according to actual scenarios

Application



deformation monitoring of large building vibration test



deformation monitoring of bridges and tunnels



wind blade deformation inspection



static and dynamic load deformation inspection of large traveling frame structures

STANDARD DELIVERY

Camera	2 pcs
Tripod	1 pc
Computer	1 pc
Three-dimension software	1 pc



Rockwell Hardness Testers
Page 819-831



Micro-Vickers Hardness Testers
Page 832-837



Vickers Hardness Testers
Page 838-843



Brinell Hardness Testers
Page 844-845



Brinell/Rockwell/Vickers Hardness Testers
Page 846-848



Brinell Indentation Automatic Measuring Systems
Page 849



Brackets
Page 850



Ultrasonic Hardness Testers
Page 851-852



Leeb Hardness Testers
Page 853-861



Magnetic Brinell/Rockwell Hardness Testers
Page 862-863



Portable Brinell And Rockwell Hardness Testers
Page 864



Pin Brinell Hardness Testers
Page 865



Hydraulic Brinell Hardness Testers
Page 866



Aluminum Hardness Testers
Page 867-868



Aluminum Hardness Testers
Page 869



Shore Durometers
Page 870-874



Fruit Hardness Testers
Page 874



Hardness Test Blocks
Page 875-876



Concrete Strength Testers
Page 877

AUTOMATIC DIGITAL ROCKWELL/SUPERFICIAL ROCKWELL HARDNESS TESTER (ADVANCED TYPE) CODE HDT-CRS200

BUILT-IN BLUETOOTH

AUTOMATIC TEST

FORCE LOADING BY ELECTRIC MOTOR (WITHOUT WEIGHTS)

TOUCH SCREEN

HIGH ACCURACY

HIGH EFFICIENCY

INSPECTION CERTIFICATE

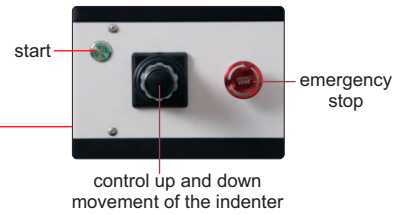
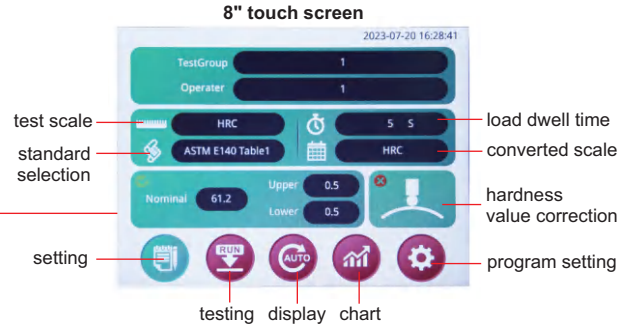

test interface

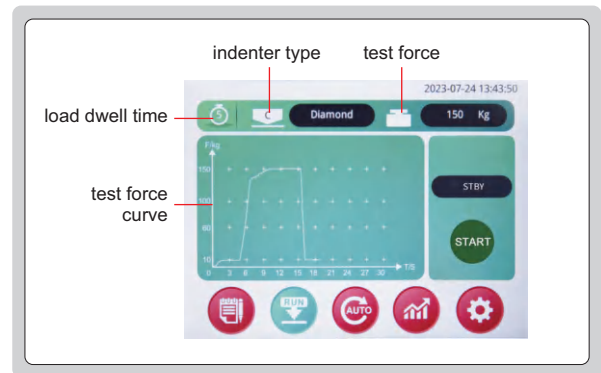

- One click operation can obtain measurement results, enabling large-scale hardness measurement of workpieces
- CNC system, close-loop electronic control system applies test force
- Touch screen operation and display
- Cantilevered structure, achieving full automation of hardness measurement
- The big flat stage is convenient for testing and can work in conjunction with robotic arms and automation equipment to step up online hardness testing and achieve completely unmanned testing
- Bluetooth, RS232 data transmission to computer, data management using hardness management software
- According to ISO 6508, ASTM E18, JIS Z2245

test result display interface

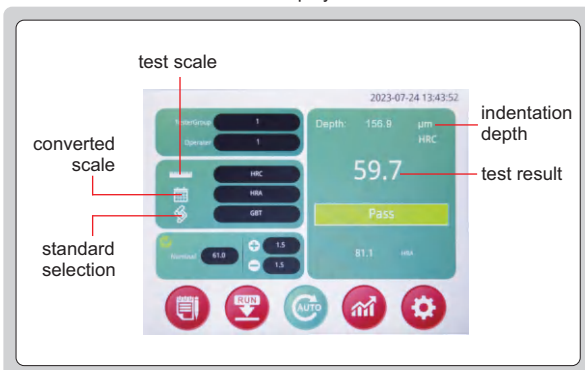
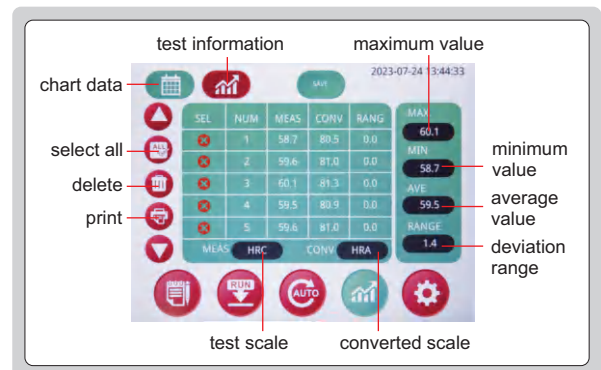

chart interface



To be continued

Continued from previous page



Ø58mm flat anvil
(included)



V-type anvil
(included)



bluetooth printer
(included)

SPECIFICATION

Measurement range		Rockwell: 20~88HRA, 20~100HRB, 20~70HRC Superficial RockWell: 70~91HR15N, 42~80HR30N, 42~70HR45N, 73~93HR15T, 43~82HR30T, 12~72HR45T
Hardness scale	with indenter included	HRA, HRB, HRC, HRD, HRF, HRG, HR15N, HR30N, HR45N, HR15T, HR30T, HR45T
	with optional indenter	HRE, HRH, HRK, HRL, HRM, HRP,HRR, HRS, HRV, HR15W, HR30W, HR45W, HR15X, HR30X, HR45X, HR15Y, HR30Y, HR45Y
Preliminary test force		Superficial Rockwell: 29.4N (3kgf) Rockwell: 98N (10kgf)
Test force		Superficial Rockwell: 147N (15kg), 294N (30kg),441N (45kg) Rockwell: 588N (60kg), 980N (100kg),1471N (150kg)
Test force accuracy		±1%
Operational mode		automatic
Load control		automatic (load/dwell/unload)
Resolution		0.05HR
Load dwell time		0~99 second
Max. workpiece height		300mm
Max. testing width		200mm (from the center of indenter to the wall of main body)
Output		bluetooth printer, RS232
Power supply		220V, 50/60Hz
Dimension		555×400×1250mm
Weight		130kg

STANDARD DELIVERY

Main unit	1 pc
Diamond indenter	1 pc
Ø1.588mm carbide ball indenter	1 pc
Ø58mm flat anvil	1 pc
V-type anvil	1 pc
Hardness test block HRB20~30	1 pc
Hardness test block HRC60~70	1 pc
Hardness test block HRB80~100	1 pc
Hardness test block HR30N60~85	1 pc
Hardness test block HR30TW70~85	1 pc
Bluetooth printer	1 pc

OPTIONAL ACCESSORY

Hardness test block HRC20~30	HDT-B-HRC1
Hardness test block HRC60~70	HDT-B-HRC3
Hardness test block HRB80~100	HDT-B-HRB
Hardness test block HR15N78~88	HDT-B-HR15N2
Hardness test block HR30N55~73	HDT-B-HR30N2
Hardness test block HR30T73~82	HDT-B-HR30T
Desk	HDT-DESK1

MOTORIZED DIGITAL ROCKWELL/SUPERFICIAL ROCKWELL HARDNESS TESTERS (DOLPHIN-NOSE TYPE)

FORCE LOADING BY ELECTRIC MOTOR (WITHOUT WEIGHTS)

TOUCH SCREEN

INSPECTION CERTIFICATE



workpiece demonstration

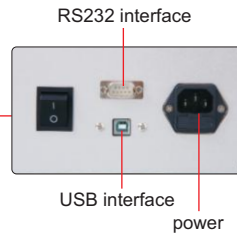

HDT-DM310

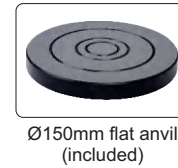

- Full closed-loop precise control, real-time monitoring of test force, greatly increase the accuracy
- Dolphin-nose structure indenter, more measuring space
- Measurements on 30 Rockwell and Superficial Rockwell scales
- Convertible to various hardness standards such as HB, HV, HLD, HK and tensile strength
- 250 sets of data are stored independently in the mainframe, which can be accessed at any time
- Mean, variance, maximum and minimum statistics are available
- USB communication port, can be connected to an external computer, measurement data Excel output
- Correction function automatically corrects the measurement results of curved parts
- Conforms to ASTM E-18, ISO 6508



integrated printer (optional)

27

test interface

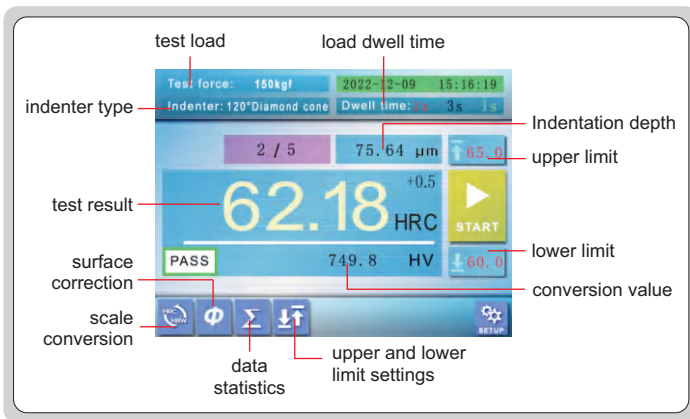

computer software (included)

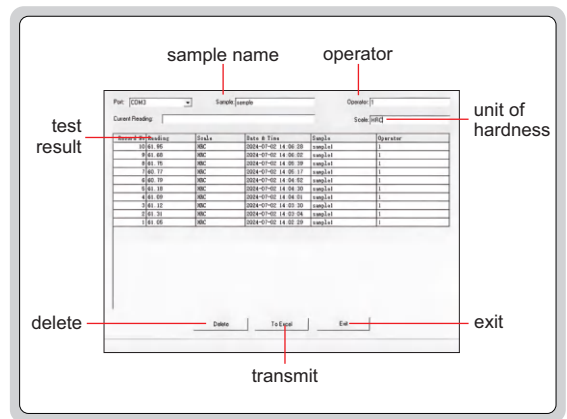

To be continued

Continued from previous page

SPECIFICATION

Code		HDT-DM290	HDT-DM300	HDT-DM310
Type		Rockwell	Superficial Rockwell	Rockwell and Superficial Rockwell
Hardness scale	with indenter included	HRA, HRB, HRC, HRD, HRF, HRG	HR15N, HR30N, HR45N, HR15T, HR30T, HR45T	HRA, HRB, HRC, HRD, HRF, HRG, HR15N, HR30N, HR45N, HR15T, HR30T, HR45T
	with optional indenter	HRE, HRH, HRK, HRL, HRM, HRP, HRR, HRS, HRV	HR15W, HR30W, HR45W, HR15X, HR30X, HR45X, HR15Y, HR30Y, HR45Y	HRE, HRH, HRK, HRL, HRM, HRP, HRR, HRS, HRV, HR15W, HR30W, HR45W, HR15X, HR30X, HR45X, HR15Y, HR30Y, HR45Y
Preliminary test force		98N/10kgf for Rockwell	29.4N/3kgf for superficial Rockwell	98N/10kgf for Rockwell 29.4N/3kgf for superficial Rockwell
Test force		588N (60kg), 980N (100kg), 1471N (150kg)	147N (15kg), 294N (30kg), 441N (45kg)	147N (15kg), 294N (30kg), 441N (45kg), 588N (60kg), 980N (100kg), 1471N (150kg)
Stage elevation		manual		
Load control		automatic (load/dwell/unload)		
Load dwell time		2~250 seconds, can be set		
Resolution		0.01HR		
Max. workpiece height		290mm		
Max. testing width		220mm		
Max. bore depth		130mm		
Min. testing inner diameter		35mm		
Power supply		220V, 50/60Hz		
Dimension		700×290×880mm		
Weight		85kg		

STANDARD DELIVERY

Code	HDT-DM290	HDT-DM300	HDT-DM310
Main unit	1 pc	1 pc	1 pc
Diamond indenter	1 pc	1 pc	1 pc
Ø1.5875mm carbide ball indenter	1 pc	1 pc	1 pc
Ø150mm flat anvil	1 pc	1 pc	1 pc
V-type anvil	1 pc	1 pc	1 pc
Hardness test block HRC20~30	1 pc	—	1 pc
Hardness test block HRC35~55	1 pc	—	1 pc
Hardness test block HRC60~70	1 pc	—	1 pc
Hardness test block HRB85~100	1 pc	—	1 pc
Hardness test block HRA80~88	1 pc	—	1 pc
Hardness test block HR15N89~91	—	1 pc	1 pc
Hardness test block HR15T88~93	—	1 pc	1 pc
Hardness test block HR30N74~80	—	1 pc	1 pc
Hardness test block HR30T70~82	—	1 pc	1 pc
Computer software and USB cable	1 pc	1 pc	1 pc
Anti-dust cover	1 pc	1 pc	1 pc

OPTIONAL ACCESSORY

Hardness test block HRC20~30	HDT-B-HRC1
Hardness test block HRC35~55	HDT-B-HRC2
Hardness test block HRC60~70	HDT-B-HRC3
Hardness test block HRB88~100	HDT-B-HRB
Hardness test block HRA80~84	HDT-B-HRA
Hardness test block HR15N78~88	HDT-B-HR15N2

Hardness test block HR15T88~93	HDT-B-HR15T
Hardness test block HR30N55~73	HDT-B-HR30N2
Hardness test block HR30T73~82	HDT-B-HR30T
Ø90mm flat anvil	HDT-DM290-FA
Ø230mm flat anvil	HDT-DM290-FB
Integrated printer (Require pre-installation)	HDT-DM290-PT

MOTORIZED DIGITAL ROCKWELL/SUPERFICIAL ROCKWELL HARDNESS TESTERS

POPULAR MODEL



INSPECTION CERTIFICATE

FORCE LOADING BY ELECTRIC MOTOR (WITHOUT WEIGHTS)

TOUCH SCREEN



Ø58mm flat anvil (included)



Ø150mm flat anvil (included)



V-type anvil (included)



printer (included)

computer software (optional)

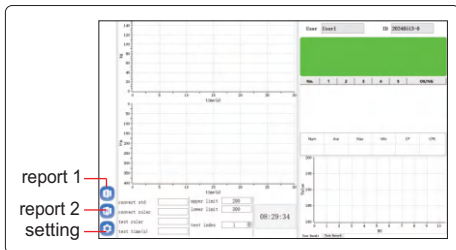

report 1
report 2
setting

test result display interface

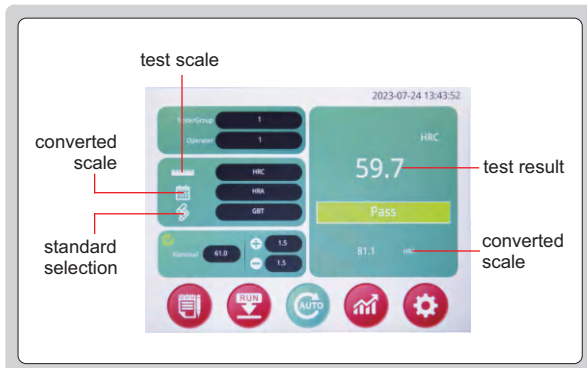

test scale
converted scale
standard selection
test result
converted scale

8" touch screen



test scales
standard selection
setting
testing
display
chart
load dwell time
converted scales
hardness value correction
program setting

the back

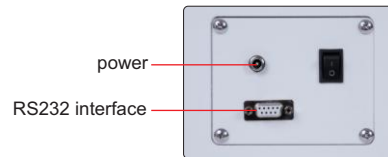

power
RS232 interface



indenter
stage
handlewheel

HDT-RT151

test interface

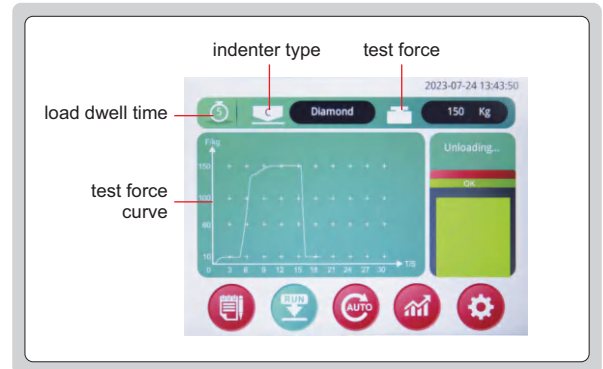

indenter type
test force
load dwell time
test force curve

chart interface

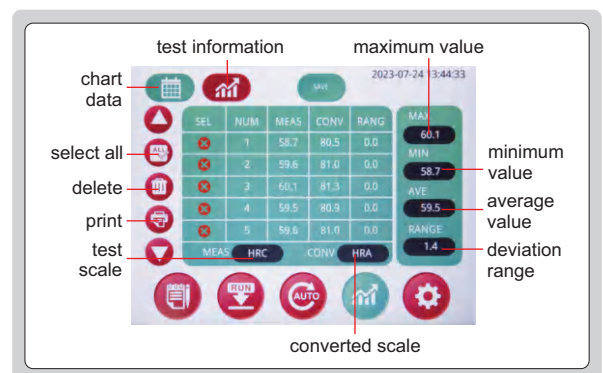

test information
maximum value
minimum value
average value
deviation range
converted scale
chart data
select all
delete
print
test scale

To be continued

Continued from previous page

- Electronic loading test force, high accuracy of force value, and stable measurement value
- Touch screen operation and display, simple operation interface
- 15 types of Rockwell hardness scales can be tested
- Convertible to various hardness standards such as HB and HV
- 500 sets of storage
- With correction function, the hardness value can be corrected based on the size of the cylinders
- According to ISO 6508

SPECIFICATION

Code		HDT-RT151	HDT-RT152	HDT-RT153
Type		Rockwell	Superficial Rockwell	Rockwell and Superficial Rockwell
Measurement range		20~88HRA, 20~100HRB, 20~70HRC	70~91HR15N, 42~80HR30N, 42~70HR45N, 73~93HR15T, 43~82HR30T, 12~72HR45T	Rockwell: 20~88HRA, 20~100HRB, 20~70HRC; Superficial Rockwell: 70~91HR15N, 42~80HR30N, 42~70HR45N, 73~93HR15T, 43~82HR30T, 12~72HR45T
Hardness scale	with indenter included	HRA, HRB, HRC, HRD, HRF, HRG	HR15N, HR30N, HR45N, HR15T, HR30T, HR45T	HRA, HRB, HRC, HRD, HRF, HRG, HR15N, HR30N, HR45N, HR15T, HR30T, HR45T
	with optional indenter	HRE, HRH, HRK, HRL, HRM, HRP, HRR, HRS, HRV	HR15W, HR30W, HR45W, HR15X, HR30X, HR45X, HR15Y, HR30Y, HR45Y	HRE, HRH, HRK, HRL, HRM, HRP, HRR, HRS, HRV, HR15W, HR30W, HR45W, HR15X, HR30X, HR45X, HR15Y, HR30Y, HR45Y
Preliminary test force		98N/10kgf for Rockwell	29.4N/3kgf for Superficial Rockwell	98N/10kgf for Rockwell 29.4N/3kgf for Superficial Rockwell
Test force		588N (60kg), 980N (100kg), 1471N (150kg)	147N (15kg), 294N (30kg), 441N (45kg)	147N (15kg), 294N (30kg), 441N (45kg), 588N (60kg), 980N (100kg), 1471N (150kg)
Stage elevation		manual		
Load control		automatic (load/dwell/unload)		
Load dwell time		2~60 second		
Resolution		0.1HR		
Max. workpiece height		230mm		
Max. testing width		170mm		
Power supply		100~240V, 50/60Hz		
Dimension		475×200×700mm		
Weight		70kg		

STANDARD DELIVERY

Code	HDT-RT151	HDT-RT152	HDT-RT153
Main unit	1 pc	1 pc	1 pc
Diamond indenter	1 pc	1 pc	1 pc
Ø1.5875mm carbide ball indenter	1 pc	1 pc	1 pc
Ø58mm flat anvil	1 pc	1 pc	1 pc
Ø150mm flat anvil	1 pc	1 pc	1 pc
V-type anvil	1 pc	1 pc	1 pc
Hardness test block HRC20~30	1 pc	—	1 pc
Hardness test block HRC40~50	1 pc	—	—
Hardness test block HRC60~70	1 pc	—	1 pc
Hardness test block HRBW80~100	1 pc	—	1 pc
Hardness test block HRA80~90	1 pc	—	—
Hardness test block HR15N80~90	—	1 pc	—
Hardness test block HR30N60~85	—	1 pc	1 pc
Hardness test block HR30TW70~85	—	1 pc	1 pc
Printer	1 pc	1 pc	1 pc
Anti-dust cover	1 pc	1 pc	1 pc

OPTIONAL ACCESSORY

Hardness test block HRC20~30	HDT-B-HRC1
Hardness test block HRC35~55	HDT-B-HRC2
Hardness test block HRC60~70	HDT-B-HRC3
Hardness test block HRB88~100	HDT-B-HRB
Hardness test block HRA80~84	HDT-B-HRA
Hardness test block HR15N78~88	HDT-B-HR15N2

Hardness test block HR30N55~73	HDT-B-HR30N2
Hardness test block HR30T73~82	HDT-B-HR30T
Software	HDT-RT15-RECEIVER
Ø12.7mm carbide ball indenter	HDT-RT15-INDENTER1
Ø6.35mm carbide ball indenter	HDT-RT15-INDENTER2
Ø3.175mm carbide ball indenter	HDT-RT15-INDENTER3

AUTOMATIC DIGITAL ROCKWELL/SUPERFICIAL ROCKWELL HARDNESS TESTERS



LARGE RANGE

AUTOMATIC LIFTING/LOADING/UNLOADING

TOUCH SCREEN

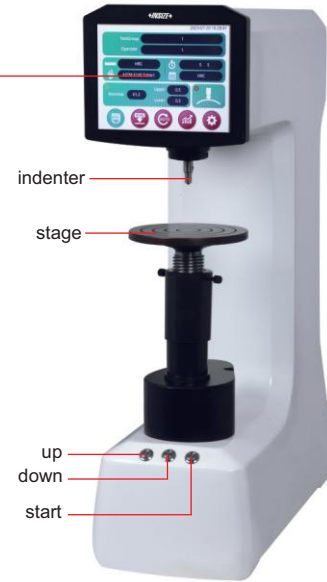
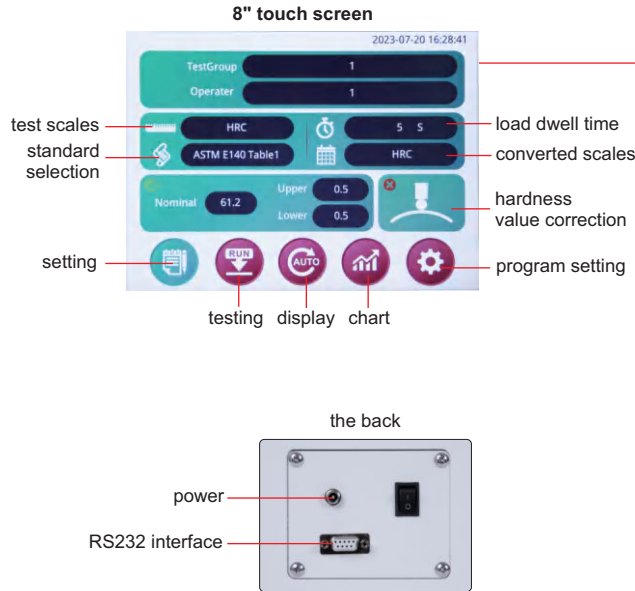

HDT-ST300

- Comply with the test standards of GB/T 230, ISO 6508, ASTM E18, JIS Z2245
- Implement the scale conversion standards such as ISO, ASTM, and GB
- 8 inch touch screen for operation and display
- Capable of testing 15 Rockwell hardness scales and surface Rockwell scales
- The main unit can independently store 500 groups of data, and the data will not be lost in case of power failure
- With correction function, the hardness value can be corrected based on the size of the cylinders

27



Ø58mm flat anvil (included)



Ø150mm flat anvil (included)



V-type anvil (included)



printer (included)

test result display interface

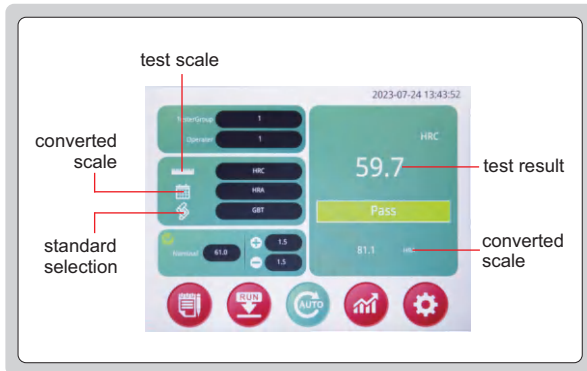
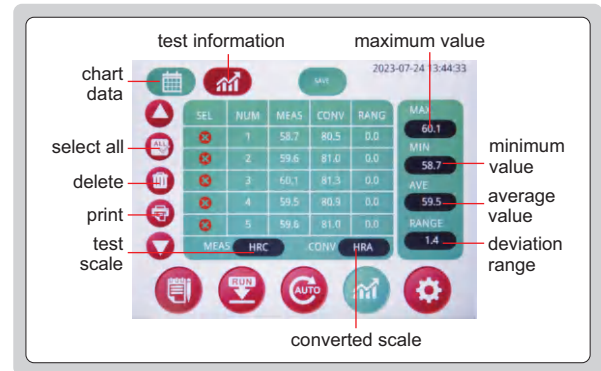

chart interface



To be continued

Continued from previous page

SPECIFICATION

Code		HDT-ST300	HDT-ST310	HDT-ST320
Type		Rockwell	Superficial Rockwell	Rockwell and Superficial Rockwell
Measurement range		20~95HRA, 10~100HRB, 10~70HRC	70~94HR15N, 42~86HR30N, 20~77HR45N, 67~93HR15T, 29~82HR30T, 10~72HR45T	Rockwell: 20~95HRA, 10~100HRB, 10~70HRC; Superficial RockWell: 70~94HR15N, 42~86HR30N, 20~77HR45N, 67~93HR15T, 29~82HR30T, 10~72HR45T
Hardness scale	with indenter included	HRA, HRB, HRC, HRD, HRF, HRG	HR15N, HR30N, HR45N, HR15T, HR30T, HR45T	HRA, HRB, HRC, HRD, HRF, HRG, HR15N, HR30N, HR45N, HR15T, HR30T, HR45T
	with optional indenter	HRE, HRH, HRK, HRL, HRM, HRP, HRR, HRS, HRV	HR15W, HR30W, HR45W, HR15X, HR30X, HR45X, HR15Y, HR30Y, HR45Y	HRE, HRH, HRK, HRL, HRM, HRP, HRR, HRS, HRV, HR15W, HR30W, HR45W, HR15X, HR30X, HR45X, HR15Y, HR30Y, HR45Y
Preliminary test force		98N/10kgf for Rockwell	29.4N/3kgf for Superficial Rockwell	98N/10kgf for Rockwell 29.4N/3kgf for Superficial Rockwell
Test force		588N (60kg), 980N (100kg), 1471N (150kg)	147N (15kg), 294N (30kg), 441N (45kg)	147N (15kg), 294N (30kg), 441N (45kg), 588N (60kg), 980N (100kg), 1471N (150kg)
Stage elevation		automatic up, down and return		
Load control		automatic (initial test force, main test force loading/holding/unloading)		
Load dwell time		2~60second		
Resolution		0.1HR		
Max. workpiece height		230mm		
Max. testing width		170mm		
Power supply		100~240V, 50/60Hz		
Dimension		475×200×700mm		
Weight		70kg		

STANDARD DELIVERY

Code	HDT-ST300	HDT-ST310	HDT-ST320
Main unit	1 pc	1 pc	1 pc
Diamond indenter	1 pc	1 pc	1 pc
Ø1.5875mm carbide ball indenter	1 pc	1 pc	1 pc
Ø58mm flat anvil	1 pc	1 pc	1 pc
Ø150mm flat anvil	1 pc	1 pc	1 pc
V-type anvil	1 pc	1 pc	1 pc
Hardness test block HRC20~30	1 pc	—	1 pc
Hardness test block HRC40~50	1 pc	—	—
Hardness test block HRC60~70	1 pc	—	1 pc
Hardness test block HRBW80~100	1 pc	1 pc	1 pc
Hardness test block HRA80~90	1 pc	—	—
Hardness test block HR15N80~90	—	1 pc	—
Hardness test block HR30N60~85	—	1 pc	1 pc
Hardness test block HR30TW70~85	—	1 pc	1 pc
Printer	1 pc	1 pc	1 pc
Anti-dust cover	1 pc	1 pc	1 pc

OPTIONAL ACCESSORY

Hardness test block HRC20~30	HDT-B-HRC1
Hardness test block HRC35~55	HDT-B-HRC2
Hardness test block HRC60~70	HDT-B-HRC3
Hardness test block HRB88~100	HDT-B-HRB
Hardness test block HRA80~84	HDT-B-HRA
Hardness test block HR15N78~88	HDT-B-HR15N2

Hardness test block HR30N55~73	HDT-B-HR30N2
Hardness test block HR30T73~82	HDT-B-HR30T
Software	HDT-RT15-HID
Ø12.7mm carbide ball indenter	HDT-RT15-INDENTER1
Ø6.35mm carbide ball indenter	HDT-RT15-INDENTER2
Ø3.175mm carbide ball indenter	HDT-RT15-INDENTER3

**MOTORIZED ROCKWELL HARDNESS TESTER (BASIC TYPE)
CODE HDT-RA151**



■ According to ISO 6508



Ø58mm flat anvil (included)



Ø150mm flat anvil (included)



V-type anvil (included) for cylinders with diameter Ø4~60mm

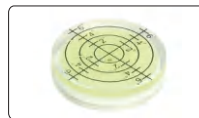

level (included)



small V-type anvil (optional) for cylinders with diameter Ø2~4mm



desk (optional)

SPECIFICATION

Hardness scale	HRA, HRB, HRC, HRD, HRF, HRG
Preliminary test force	98N
Test force	588N, 980N, 1471N
Display	analogue
Stage elevation	manual
Load control	automatic (load/dwell/unload)
Load dwell time	1~60 second
Min. reading	0.5HR
Max. workpiece height	170mm
Max. testing width	128mm (from the center of indenter to the wall of main body)
Power supply	220V, 50/60Hz
Dimension	500×225×640mm
Weight	65kg

STANDARD DELIVERY

Main unit	1 pc
Ø58mm flat anvil	1 pc
Ø150mm flat anvil	1 pc
V-type anvil	1 pc
Diamond indenter	1 pc
Ø1.5875mm steel ball indenter	1 pc
Level	1 pc
Hardness test block HRA80~88	1 pc
Hardness test block HRB85~95	1 pc
Hardness test block HRC20~30	1 pc
Hardness test block HRC35~55	1 pc
Hardness test block HRC60~70	1 pc
Anti-dust cover	1 pc

OPTIONAL ACCESSORY

Hardness test block HRA80~84	HDT-B-HRA
Hardness test block HRB88~100	HDT-B-HRB
Hardness test block HRC20~30	HDT-B-HRC1
Hardness test block HRC35~55	HDT-B-HRC2
Hardness test block HRC60~70	HDT-B-HRC3
Small V-type anvil	HDT-RW160-SV
Desk	HDT-DESK

MOTORIZED HIGH ROCKWELL HARDNESS TESTER CODE HDT-RM421

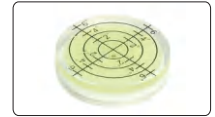

level (included)



V-type anvil (included)
for cylinders with
diameter Ø4~60mm



Ø150mm flat anvil
(included)



Ø58mm flat anvil
(included)



small V-type anvil
(optional) for
cylinders with
diameter Ø2~4mm

■ According to ISO 6508

SPECIFICATION

Hardness scale	HRA, HRB, HRC, HRD, HRF, HRG
Preliminary test force	98N (10kg)
Test force	588N (60kg), 980N (100kg), 1471N (150kg)
Display	analogue
Stage elevation	manual
Load control	automatic (load/dwell/unload)
Load dwell time	1~60 second
Min. reading	0.5HR
Max. workpiece height	400mm
Max. testing width	160mm (form the center of indenter to the wall of main body)
Power supply	220V, 50/60Hz
Dimension	540×300×1030mm
Weight	140kg

STANDARD DELIVERY

Main unit	1 pc
Ø58mm flat anvil	1 pc
Ø150mm flat anvil	1 pc
V-type anvil	1 pc
Diamond indenter	1 pc
Ø1.5875mm steel ball indenter	1 pc
Ø1.5875mm steel ball	5 pcs
Level	1 pc
Hardness test block HRA80~84	1 pc
Hardness test block HRB88~100	1 pc
Hardness test block HRC20~30	1 pc
Hardness test block HRC35~55	1 pc
Hardness test block HRC60~70	1 pc
Anti-dust cover	1 pc

OPTIONAL ACCESSORY

Hardness test block HRA80~84	HDT-B-HRA
Hardness test block HRB88~100	HDT-B-HRB
Hardness test block HRC20~30	HDT-B-HRC1
Hardness test block HRC35~55	HDT-B-HRC2
Hardness test block HRC60~70	HDT-B-HRC3
Small V-type anvil	HDT-RW160-SV

MANUAL HIGH ROCKWELL HARDNESS TESTER CODE HDT-RH411

INSPECTION
CERTIFICATE

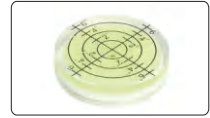

level (included)



V-type anvil (included)
for cylinders with
diameter Ø4-60mm



Ø150mm flat anvil
(included)



Ø58mm flat anvil
(included)



small V-type anvil
(optional) for
cylinders with
diameter Ø2-4mm

■ According to ISO 6508

SPECIFICATION

Hardness scale	HRA, HRB, HRC, HRD, HRF, HRG
Preliminary test force	98N (10kg)
Test force	588N (60kg), 980N (100kg), 1471N (150kg)
Display	analogue
Stage elevation	manual
Load control	manual
Min. reading	0.5HR
Max. workpiece height	400mm
Max. testing width	160mm (form the center of indenter to the wall of main body)
Dimension	540×300×1030mm
Weight	140kg

STANDARD DELIVERY

Main unit	1 pc
Ø58mm flat anvil	1 pc
Ø150mm flat anvil	1 pc
V-type anvil	1 pc
Diamond indenter	1 pc
Ø1.5875mm steel ball indenter	1 pc
Ø1.5875mm steel ball	5 pcs
Level	1 pc
Hardness test block HRA80~84	1 pc
Hardness test block HRB88~100	1 pc
Hardness test block HRC20~30	1 pc
Hardness test block HRC35~55	1 pc
Hardness test block HRC60~70	1 pc
Anti-dust cover	1 pc

OPTIONAL ACCESSORY

Hardness test block HRA80~84	HDT-B-HRA
Hardness test block HRB88~100	HDT-B-HRB
Hardness test block HRC20~30	HDT-B-HRC1
Hardness test block HRC35~55	HDT-B-HRC2
Hardness test block HRC60~70	HDT-B-HRC3
Small V-type anvil	HDT-RW160-SV

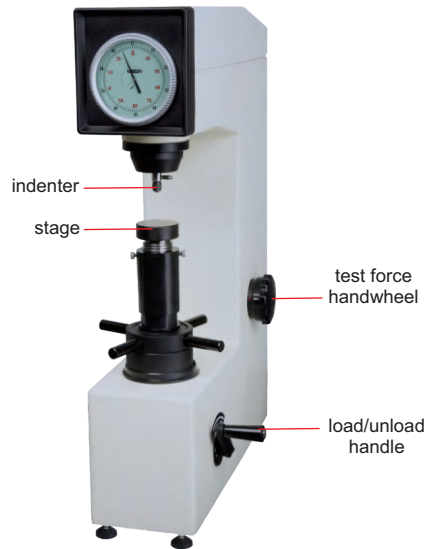

■ According to ISO 6508



Ø60mm flat anvil
(included)



Ø150mm flat anvil
(included)



V-type anvil (included)
for cylinders with
diameter Ø4~60mm



small V-type anvil
(optional)
for cylinders with
diameter Ø2~4mm



desk (optional)

SPECIFICATION

Hardness scale	HRA, HRB, HRC, HRD, HRF, HRG
Preliminary test force	98N
Test force	588N, 980N, 1471N
Display	analogue
Stage elevation	manual
Load control	manual
Min. reading	0.5HR
Max. workpiece height	170mm
Max. testing width	165mm (from the center of indenter to the wall of main body)
Dimension	520×160×700mm
Weight	60kg

STANDARD DELIVERY

Main unit	1 pc
Ø60mm flat anvil	1 pc
Ø150mm flat anvil	1 pc
V-type anvil	1 pc
Diamond indenter	1 pc
Ø1.5875mm carbide ball indenter	1 pc
Hardness test block HRB88~95	1 pc
Hardness test block HRC60~65	1 pc
Hardness test block HRC20~30	1 pc
Anti-dust cover	1 pc

OPTIONAL ACCESSORY

Hardness test block HRB88~100	HDT-B-HRB
Hardness test block HRC60~70	HDT-B-HRC3
Hardness test block HRC20~30	HDT-B-HRC1
Small V-type anvil	ISH-SMALLANVIL
Desk	HDT-DESK

MANUAL ROCKWELL HARDNESS TESTER (BASIC TYPE) CODE HDT-RW160



**POPULAR
MODEL**

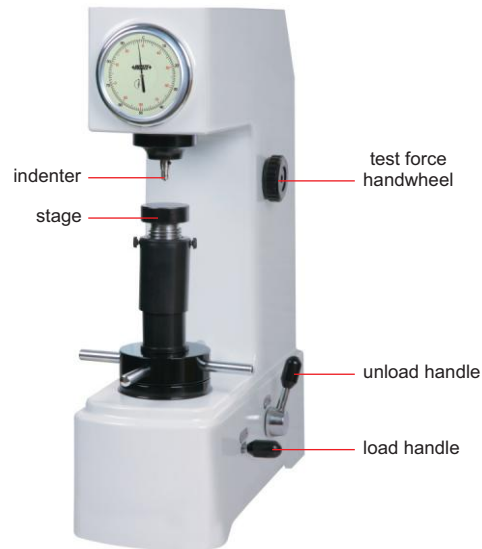

■ According to ISO 6508



Ø58mm flat anvil
(included)



Ø150mm flat anvil
(included)



V-type anvil (included)
for cylinders with
diameter Ø4~60mm

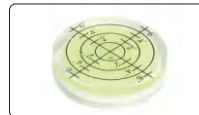

level (included)



small V-type anvil
(optional) for
cylinders with
diameter Ø2~4mm



desk (optional)

SPECIFICATION

Hardness scale	HRA, HRB, HRC, HRD, HRF, HRG
Preliminary test force	98N (10kg)
Test force	588N (60kg), 980N (100kg), 1471N (150kg)
Display	analogue
Stage elevation	manual
Load control	manual
Min. reading	0.5HR
Max. workpiece height	170mm
Max. testing width	135mm (from the center of indenter to the wall of main body)
Dimension	466×238×630mm
Weight	70kg

STANDARD DELIVERY

Main unit	1 pc
Ø58mm flat anvil	1 pc
Ø150mm flat anvil	1 pc
V-type anvil	1 pc
Diamond indenter	1 pc
Ø1.5875mm steel ball indenter	1 pc
Ø1.5875mm steel ball	5 pcs
Level	1 pc
Hardness test block HRA80~88	1 pc
Hardness test block HRB85~95	1 pc
Hardness test block HRC20~30	1 pc
Hardness test block HRC35~55	1 pc
Hardness test block HRC60~70	1 pc
Anti-dust cover	1 pc

OPTIONAL ACCESSORY

Hardness test block HRA80~84	HDT-B-HRA
Hardness test block HRB88~100	HDT-B-HRB
Hardness test block HRC20~30	HDT-B-HRC1
Hardness test block HRC35~55	HDT-B-HRC2
Hardness test block HRC60~70	HDT-B-HRC3
Small V-type anvil	HDT-RW160-SV
Desk	HDT-DESK

MOTOR DRIVEN
TURRET

TOUCH
SCREEN



DIGITAL MICRO-VICKERS HARDNESS TESTER (BASIC TYPE) CODE HDT-MVE1300

**INSPECTION
CERTIFICATE**

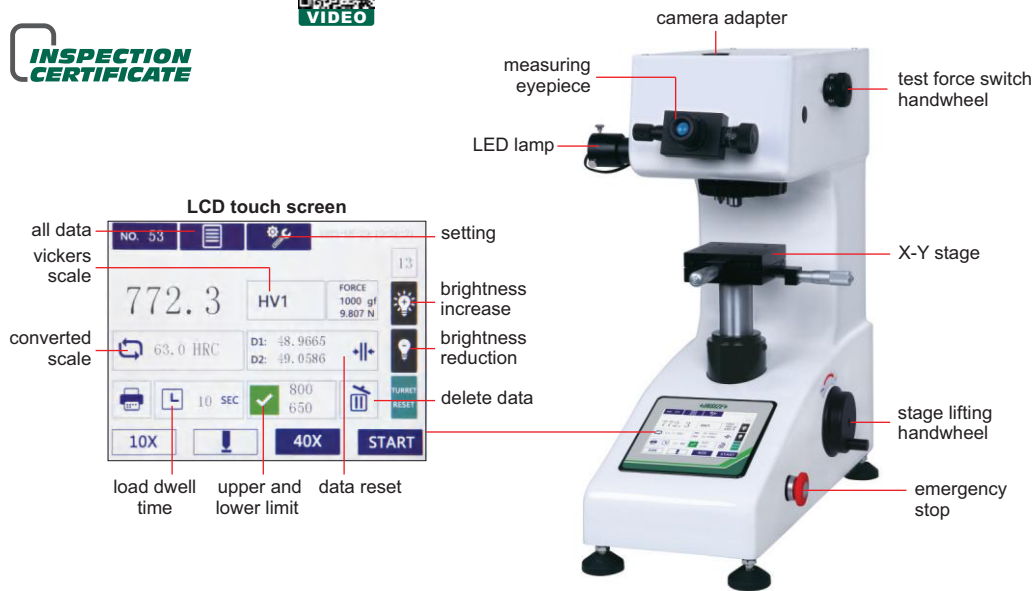

step: 1



measure indentation diagonal lengths by measuring microscope

step: 2

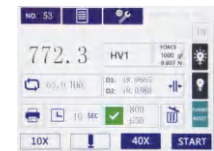

input the indentation diagonal lengths, the hardness value is shown on screen automatically

- Touch screen color LCD display
- Data storage and average value calculation
- Automatic switch between the indenter and objective lens
- According to ISO 6507



cylinder holder (included)



slice holder (included)



vice (included)



desk (optional)



camera (optional)

camera and measuring software (optional)



SPECIFICATION

Test force	0.098N (10gf), 0.245N (25gf), 0.49N (50gf), 0.98N (100gf), 1.96N (200gf), 2.94N (300gf), 4.9N (500gf), 9.8N (1kgf)
Vickers scales	HV0.01, HV0.025, HV0.05, HV0.1, HV0.2, HV0.3, HV0.5, HV1
Converted scales	HRA, HRB, HRC, HRD, HRF, HV, HK, HBW, HR15N, HR30N, HR45N, HR15T, HR30T, HR45T
Range	5~3000HV
Length measurement resolution	0.5µm
Objective/indenter switch	motor driven turret
Stage lifting	manual
Load control	automatic (load/dwell/unload)
Load dwell time	1~60 second
Objective	10X, 40X
Eyepiece	10X
Total magnification	100X (for measurement or observation), 400X (for measurement)
Max. workpiece height	90mm
Max. testing width	95mm (from the center of indenter to the wall of main body)
X-Y stage	dimension: 100×100mm, travel range: 25×25mm
Power supply	220V, 50/60Hz
Dimension	510×290×570mm
Weight	40kg

STANDARD DELIVERY

Main unit	1 pc
10X, 40X objective	1 pc of each
Micro vickers indenter	1 pc
Hardness test block 400~500HV0.2	1 pc
Hardness test block 700~750HV1	1 pc
Slice holder	1 pc
Vice	1 pc
Cylinder holder	1 pc
Anti-dust cover	1 pc

OPTIONAL ACCESSORY

Hardness test block 400~500HV0.2	HDT-B-HV02C
Hardness test block 700~750HV1	HDT-B-HV1F
Knoop indenter	HDT-MV-KNOOP
Camera	HDT-MVH-CM
Measuring software (manual)	HDT-MVH-SW
Measuring software (automatic)	HDT-MVH-AW
Desk	HDT-DESK

DIGITAL MICRO-VICKERS HARDNESS TESTER (STANDARD TYPE) CODE HDT-MVH1100



PRESS INPUT BUTTON TO HAVE DIRECT READING OF HARDNESS



TOUCH SCREEN

MOTOR DRIVEN TURRET

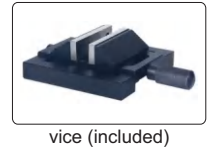
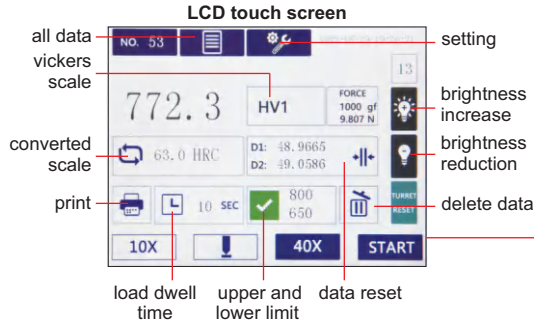

- Touch screen color LCD display
- Data storage and average value calculation
- Automatic switch between the indenter and objective lens
- According to ISO 6507



camera (optional)

camera and measuring software (optional)



SPECIFICATION

Test force	0.098N (10gf), 0.245N (25gf), 0.49N (50gf), 0.98N (100gf), 1.96N (200gf), 2.94N (300gf), 4.9N (500gf), 9.8N (1kgf)
Vickers scales	HV0.01, HV0.025, HV0.05, HV0.1, HV0.2, HV0.3, HV0.5, HV1
Converted scales	HRA, HRB, HRC, HRD, HRF, HV, HK, HBW, HR15N, HR30N, HR45N, HR15T, HR30T, HR45T
Range	5~3000HV
Length measurement resolution	0.025µm
Objective/indenter switch	motor driven turret
Stage lifting	manual
Load control	automatic (load/dwell/unload)
Load dwell time	1~60 second
Objective	10X, 40X
Eyepiece	10X
Total magnification	10X (for measurement or observation), 400X (for measurement)
Max. workpiece height	90mm
Max. testing width	95mm (from the center of indenter to the wall of main body)
X-Y stage	dimension: 100×100mm, travel range: 25×25mm
Data output	built-in printer
Power supply	220V, 50/60Hz
Dimension	510×290×570mm
Weight	40kg

STANDARD DELIVERY

Main unit	1 pc
10X, 40X objective	1 pc of each
Micro vickers indenter	1 pc
Hardness test block 400~500HV0.2	1 pc
Hardness test block 700~750HV1	1 pc
Slice holder	1 pc
Vice	1 pc
Cylinder holder	1 pc
Anti-dust cover	1 pc

OPTIONAL ACCESSORY

Hardness test block 400~500HV0.2	HDT-B-HV02C
Hardness test block 700~750HV1	HDT-B-HV1F
Knoop indenter	HDT-MV-KNOOP
Camera	HDT-MVH-CM
Measuring software (manual)	HDT-MVH-SW
Measuring software (automatic)	HDT-MVH-AW



DUAL TOUCH SCREEN DIGITAL MICRO-VICKERS HARDNESS TESTER (ADVANCED TYPE) CODE HDT-DMV90

MOTOR DRIVEN TURRET

AUTOMATIC TEST

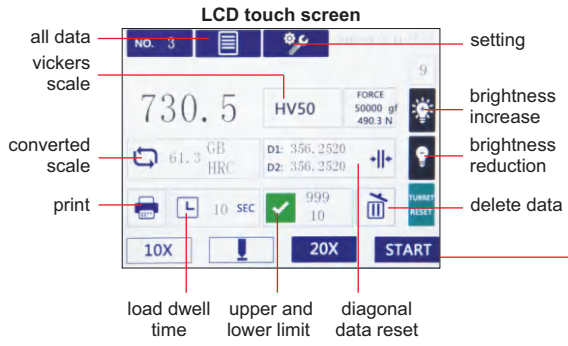
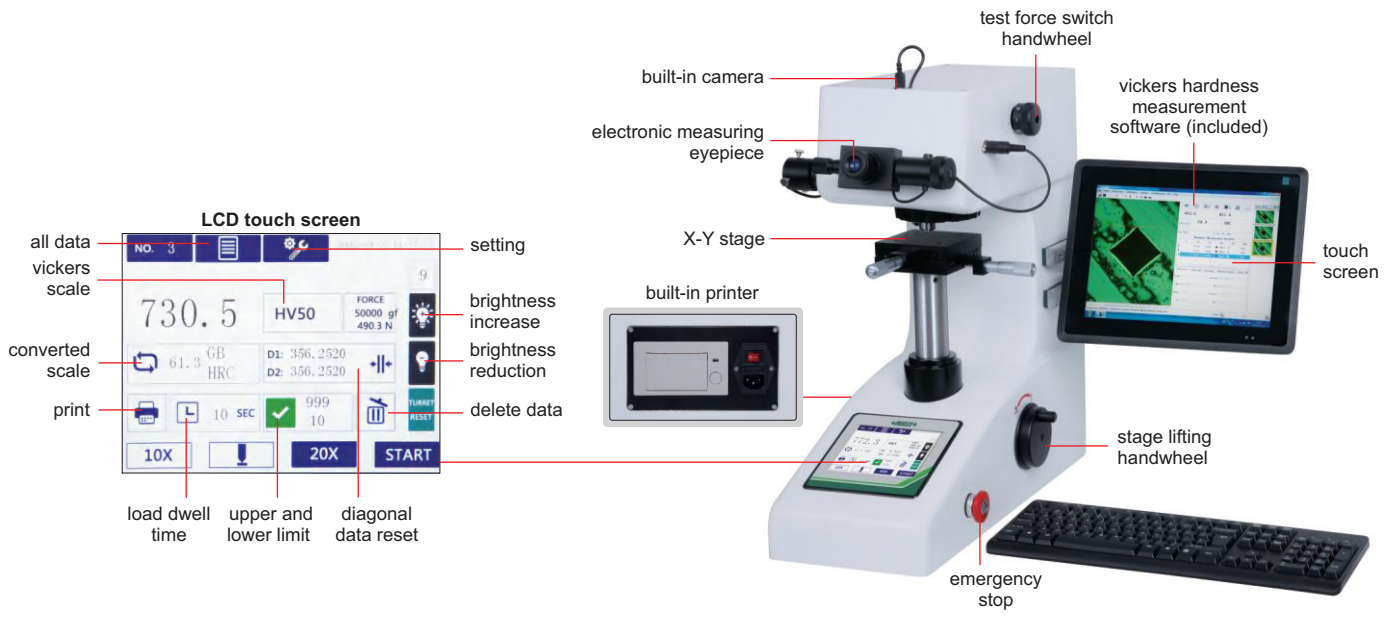

vickers hardness measurement software (included)

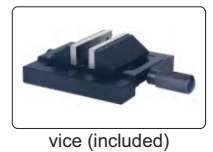
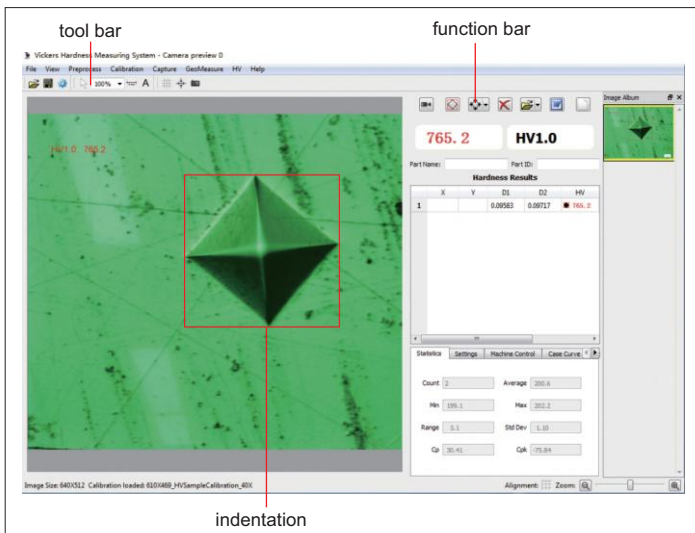

- Dual touch screen control, high-definition image measurement and analysis
- One click start, automatic pressing and automatic measurement
- The host and vickers hardness measurement software can be operated independently
- Automatic switch between the indenter and objective lens
- Data storage and average value calculation
- Can connect with wired and wireless networks to transmit data
- According to ISO 6507

To be continued

Continued from previous page

SPECIFICATION

Test force	0.098N (10gf), 0.245N (25gf), 0.49N (50gf), 0.98N (100gf), 1.96N (200gf), 2.94N (300gf), 4.9N (500gf), 9.8N (1kgf)
Vickers scales	HV0.01, HV0.025, HV0.05, HV0.1, HV0.2, HV0.3, HV0.5, HV1
Converted scales	HRA, HRB, HRC, HRD, HRF, HV, HK, HBW, HR15N, HR30N, HR45N, HR15T, HR30T, HR45T
Range	5~3000HV
Length measurement resolution	0.01 μ m
Objective/indenter switch	motor driven turret
Stage lifting	manual
Load control	automatic (load/dwell/unload)
Load dwell time	1~60 second
Objective	10X, 40X
Eyepiece	10X
Total magnification	100X (for measurement or observation), 400X (for measurement)
Max. workpiece height	90mm
Max. testing width	95mm (from the center of indenter to the wall of main body)
X-Y stage	dimensions: 100 \times 100mm, travel range: 25 \times 25mm
Data output	built-in printer, USB
Power supply	220V, 50/60Hz
Dimension	500 \times 420 \times 480mm
Weight	42kg

STANDARD DELIVERY

Main unit	1 pc
Vickers hardness measurement software	1 pc
10X, 40X objective	1 pc of each
Micro vickers indenter	1 pc
Hardness test block 400~500HV0.2	1 pc
Hardness test block 700~750HV1	1 pc
Wireless keyboard	1 pc
Wireless mouse	1 pc
Vice	1 pc
Slice holder	1 pc
Cylinder holder	1 pc
Anti-dust cover	1 pc

OPTIONAL ACCESSORY

Hardness test block 400~500HV0.2	HDT-B-HV02C
Hardness test block 700~750HV1	HDT-B-HV1F
Knoop indenter	HDT-MV-KNOOP
Desk	HDT-DESK
OFFICE software	7313-OFFICE

MOTOR DRIVEN
TURRET

AUTOMATIC
TEST

Z-AXIS
AUTOFOCUS

AUTOMATIC MICRO-VICKERS HARDNESS TESTER CODE HDT-AMV338

INSPECTION
CERTIFICATE

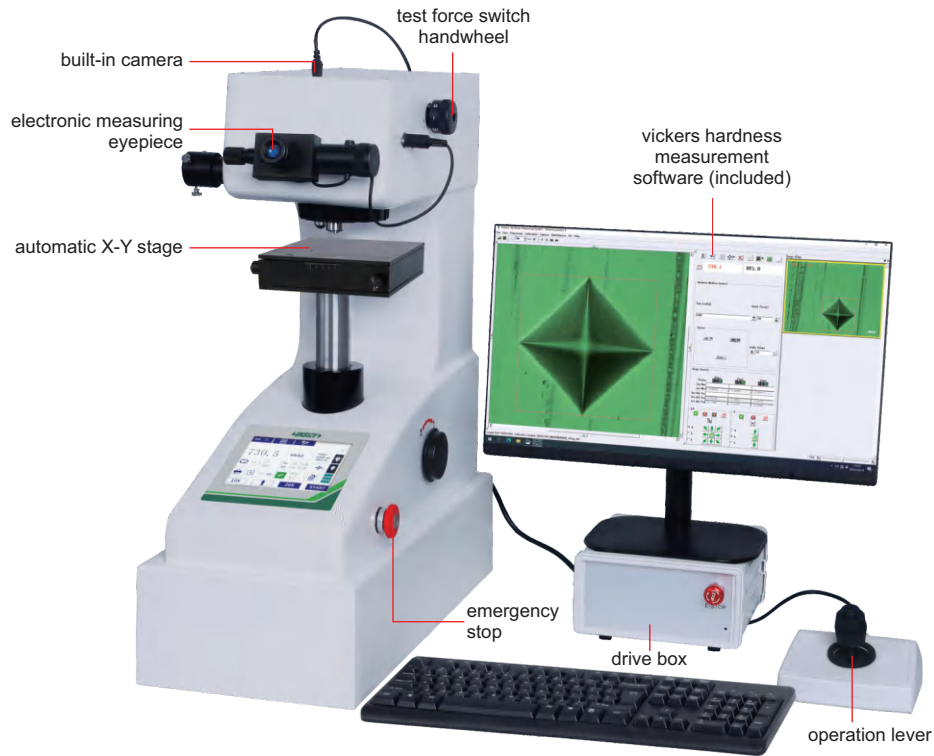

automatic X-Y stage



cylinder holder (included)



vice (included)



slice holder (included)



desk (optional)

- Suitable for micro-hardness determination of various metals and non-metal materials, effective depth and heat affected area measurement, especially suitable for measuring workpieces hardness gradient distribution curve and surface hardness after heat treatment, effective hardening layer depth
- Automatic switch between the indenter and objective lens
- Z-axis automatic focus, X, Y axis automatic movement, can be for multi-point continuous measurement
- Automatic moving table by built-in step motor, high positioning accuracy, good repeatability, fast moving speed, high efficiency
- Automatic moving table bidirectional movement, equipped with safety devices to avoid misoperation
- The software can control the hardness tester hardware operation, two-way communication with each other
- The image acquisition device has fast reaction speed, high automatic measurement accuracy and good repeatability
- The system can automatically generate Word or Excel test report, and the report template can be modified
- According to ISO 6507

vickers hardness measurement software (included)

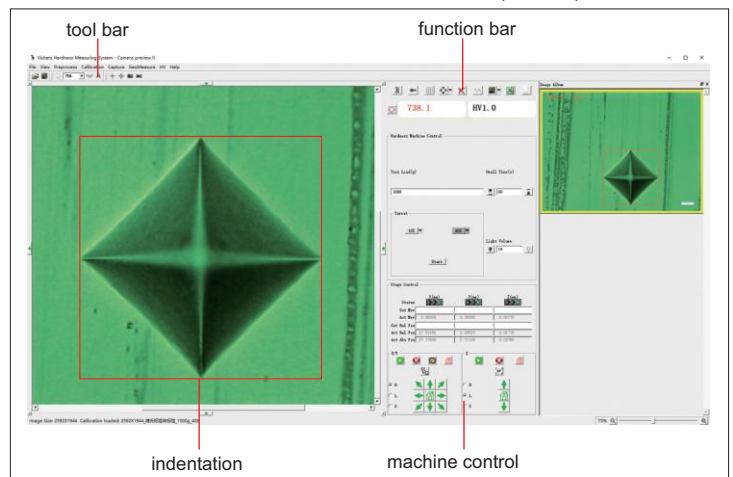

To be continued

Continued from previous page

AUTOMATIC TEST CONTROL SYSTEM

Hardness tester control	1. automatic turret, automatic loading, automatic measurement 2. automatic display of test force, load dwell time, illumination brightness
Automatic control of X-Y stage	software system automatic control of X-Y stage movement
Measurement mode	1. automatic mode: automatic loading, automatic measurement, automatic display of measurement results 2. manual measurement mode can be selected
Automatic measurement	about 0.3sec of one indentation
Measurement repeatability	±1% (700HV/500gf)
The smallest indentation that can be measured	about 5μm (automatic measurement)
Data output format/edit functions	1. inspection reports can be customized according to customer requirements 2. the depth of hardened layer is shown in table form 3. output various measurement data, hardness table, hardening layer depth, maximum value, average value, minimum value, image with hardness value

AUTOMATIC X-Y STAGE

Drive motor	step motor
Drive control	movement control by software, speed is adjustable
Dimension	110×110mm
Max. travel distance	50×50mm
Min. travel distance	1μm
Movement speed	1~10mm/sec, speed can be adjusted
Displacement repetition accuracy	within 1μm

SPECIFICATION

Test force	0.098N (10gf), 0.245N (25gf), 0.49N (50gf), 0.98N (100gf), 1.96N (200gf), 2.94N (300gf), 4.9N (500gf), 9.8N (1kgf)
Vickers scales	HV0.01, HV0.025, HV0.05, HV0.1, HV0.2, HV0.3, HV0.5, HV1
Converted scales	HRA, HRB, HRC, HRD, HRF, HV, HK, HBW, HR15N, HR30N, HR45N, HR15T, HR30T, HR45T
Range	5~3000HV
Length measurement resolution	0.01μm
Objective/indenter switch	motor driven turret
Stage lifting	manual
Focus mode	Z-axis autofocus
Load control	automatic (load/dwell/unload)
Load dwell time	1~60 second
Objective	10X, 40X
Eyepiece	10X
Total magnification	100X (for measurement or observation), 400X (for measurement)
Max. workpiece height	80mm
Max. testing width	110mm (from the center of indenter to the wall of main body)
Pixel	5M
Communication interface	RS232
Power supply	220V, 50/60Hz
Dimension	520×290×680mm
Weight	42kg

STANDARD DELIVERY

Main unit	1 pc
10X, 40X objective	1 pc of each
Micro vickers indenter	1 pc
Hardness test block 400~500HV0.2	1 pc
Hardness test block 700~750HV1	1 pc
Automatic X-Y stage drive box	1 pc
Vickers hardness measurement software	1 pc
Computer	1 pc
Vice	1 pc
Slice holder	1 pc
Cylinder holder	1 pc
Anti-dust cover	1 pc

OPTIONAL ACCESSORY

Hardness test block 400~500HV0.2	HDT-B-HV02C
Hardness test block 700~750HV1	HDT-B-HV1F
Knoop indenter	HDT-MV-KNOOP
Desk	HDT-DESK
OFFICE software	7313-OFFICE



MOTOR DRIVEN TURRET

TOUCH SCREEN

DIGITAL VICKERS HARDNESS TESTERS (BASIC TYPE)

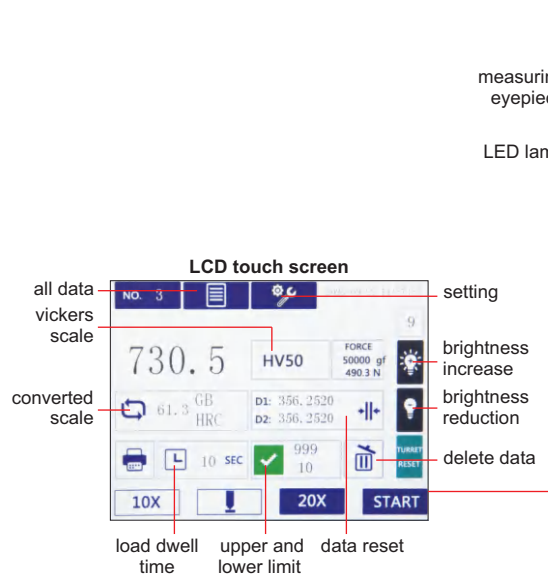

HDT-VE56

- Touch screen color LCD display
- Data storage and average value calculation
- Automatic switch between the indenter and objective lens
- According to ISO 6507

<p>step: 1</p> <p>measure indentation diagonal lengths by measuring microscope</p>	<p>step: 2</p> <p>input the indentation diagonal lengths, the hardness value is shown on screen automatically</p>
--	---

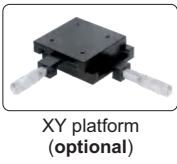

Continued from previous page

vickers hardness measurement software (optional)

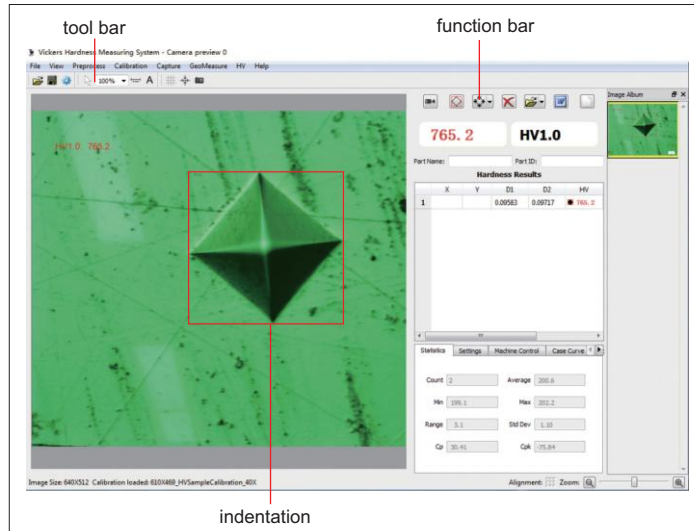

SPECIFICATION

Code	HDT-VE03	HDT-VE14	HDT-VE35	HDT-VE56
Test force	0.3kgf, 0.5kgf, 1kgf, 2kgf, 3kgf, 5kgf	0.3kgf, 0.5kgf, 1kgf, 3kgf, 5kgf, 10kgf	1kgf, 3kgf, 5kgf, 10kgf, 20kgf, 30kgf	1kgf, 5kgf, 10kgf, 20kgf, 30kgf, 50kgf
Vickers scales	HV0.3, HV0.5, HV1, HV2, HV3, HV5	HV0.3, HV0.5, HV1, HV3, HV5, HV10	HV1, HV3, HV5, HV10, HV20, HV30	HV1, HV5, HV10, HV20, HV30, HV50
Converted scales	HRA, HRB, HRC, HRD, HRF, HV, HK, HBW, HR15N, HR30N, HR45N, HR15T, HR30T, HR45T			
Range	8~3000HV			
Length measurement resolution	0.5µm			
Objective/indenter switch	motor driven turret			
Stage lifting	manual			
Load control	automatic (load/dwell/unload)			
Load dwell time	1~60 second			
Objective	10X, 20X			
Eyepiece	10X			
Total magnification	100X (for measurement or observation), 200X (for measurement)			
Max. workpiece height	175mm			
Max. testing width	135mm (form the center of indenter to the wall of main body)			
Power supply	220V, 50/60Hz			
Dimension	580×320×660mm			
Weight	55kg			

STANDARD DELIVERY

Main unit	1 pc
10X, 20X objective	1 pc of each
Vickers indenter	1 pc
Hardness test block 400~500HV10	1 pc
Hardness test block 700~750HV50	1 pc
Ø58mm flat anvil	1 pc
Ø150mm flat anvil	1 pc
V-type anvil	1 pc
Anti-dust cover	1 pc

OPTIONAL ACCESSORY

Hardness test block 400~500HV10	HDT-B-HV10D
Hardness test block 700~750HV50	HDT-B-HV50G
Desk	HDT-DESK
Vickers hardness tester camera (fit 5kg and 10kg)	HDT-MVH-CM1
Vickers hardness tester camera (fit 30kg and 50kg)	HDT-MVH-CM2
XY working platform	HDT-VEH-ST
Measuring software (manual)	HDT-MVH-SW
Measuring software (automatic)	HDT-MVH-AW

DIGITAL VICKERS HARDNESS TESTERS (STANDARD TYPE)

MOTOR DRIVEN TURRET

PRESS INPUT BUTTON TO HAVE DIRECT READING OF HARDNESS

TOUCH SCREEN

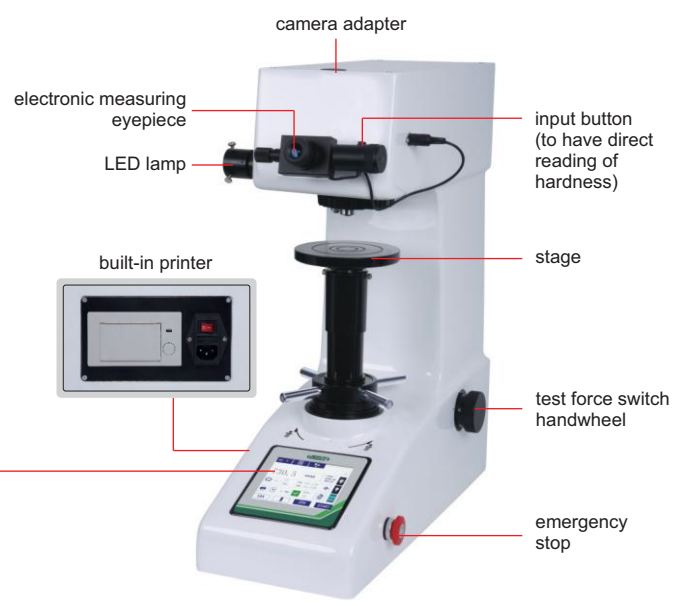
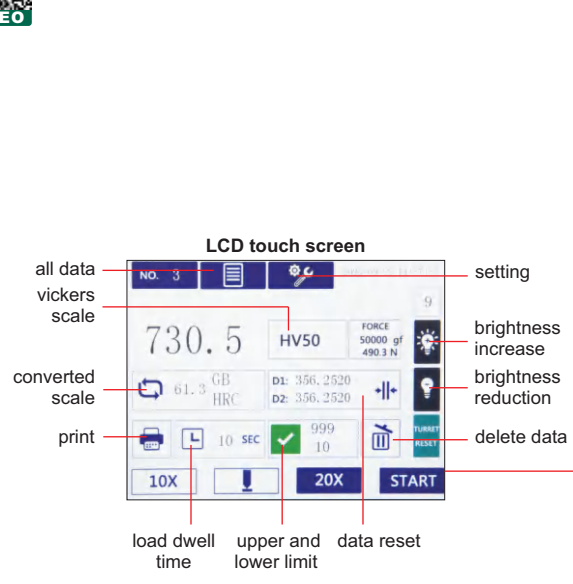

HDT-VH51

- Touch screen color LCD display
- Data storage and average value calculation
- Automatic switch between the indenter and objective lens
- According to ISO 6507



Ø58mm flat anvil (included)

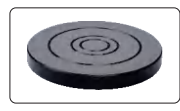

Ø150mm flat anvil (included)



XY platform (optional)



V-type anvil (included)



desk (optional)



camera (optional)



Continued from previous page

vickers hardness measurement software (optional)

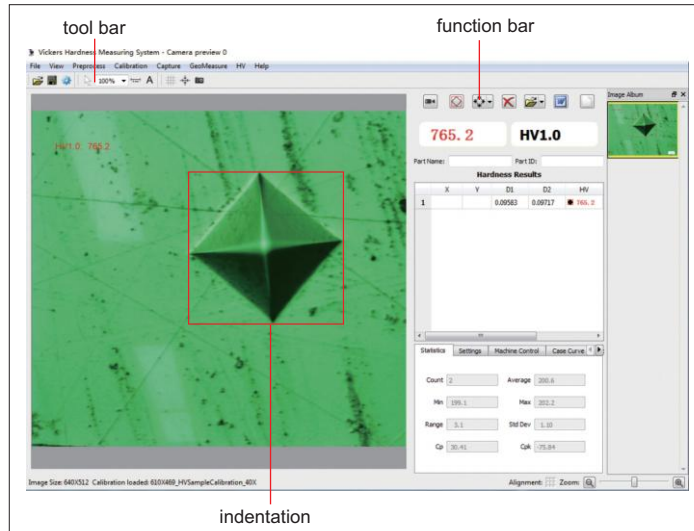

SPECIFICATION

Code	HDT-VH05	HDT-VH11	HDT-VH31	HDT-VH51
Test force	0.3kgf, 0.5kgf, 1kgf, 2kgf, 3kgf, 5kgf	0.3kgf, 0.5kgf, 1kgf, 3kgf, 5kgf, 10kgf	1kgf, 3kgf, 5kgf, 10kgf, 20kgf, 30kgf	1kgf, 5kgf, 10kgf, 20kgf, 30kgf, 50kgf
Vickers scales	HV0.3, HV0.5, HV1, HV2, HV3, HV5	HV0.3, HV0.5, HV1, HV3, HV5, HV10	HV1, HV3, HV5, HV10, HV20, HV30	HV1, HV5, HV10, HV20, HV30, HV50
Converted scales	HRA, HRB, HRC, HRD, HRF, HV, HK, HBW, HR15N, HR30N, HR45N, HR15T, HR30T, HR45T			
Range	8~3000HV			
Length measurement resolution	0.125µm			
Objective/indenter switch	motor driven turret			
Stage lifting	manual			
Load control	automatic (load/dwell/unload)			
Load dwell time	1~60 second			
Objective	10X, 20X			
Eyepiece	10X			
Total magnification	100X (for measurement or observation), 200X (for measurement)			
Max. workpiece height	175mm			
Max. testing width	135mm (form the center of indenter to the wall of main body)			
Output	built-in printer			
Power supply	220V, 50/60Hz			
Dimension	580×320×660mm			
Weight	55kg			

STANDARD DELIVERY

Main unit	1 pc
10X, 20X objective	1 pc of each
Vickers indenter	1 pc
Hardness test block	2 pcs
Ø58mm flat anvil	1 pc
Ø150mm flat anvil	1 pc
V-type anvil	1 pc
Anti-dust cover	1 pc

OPTIONAL ACCESSORY

Hardness test block	page 875~876
Desk	HDT-DESK
Vickers hardness tester camera (fits 5kgf and 10kgf)	HDT-MVH-CM1
Vickers hardness tester camera (fits 30kgf and 50kgf)	HDT-MVH-CM2
XY working platform	HDT-VEH-ST
Measuring software (manual)	HDT-MVH-SW
Measuring software (automatic)	HDT-MVH-AW

AUTOMATIC VICKERS HARDNESS TESTERS

MOTOR DRIVEN TURRET

AUTOMATIC TEST

Z-AXIS AUTO FOCUS



INSPECTION CERTIFICATE

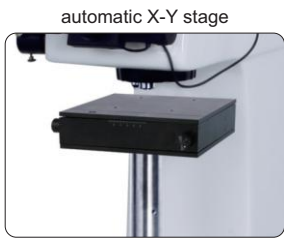
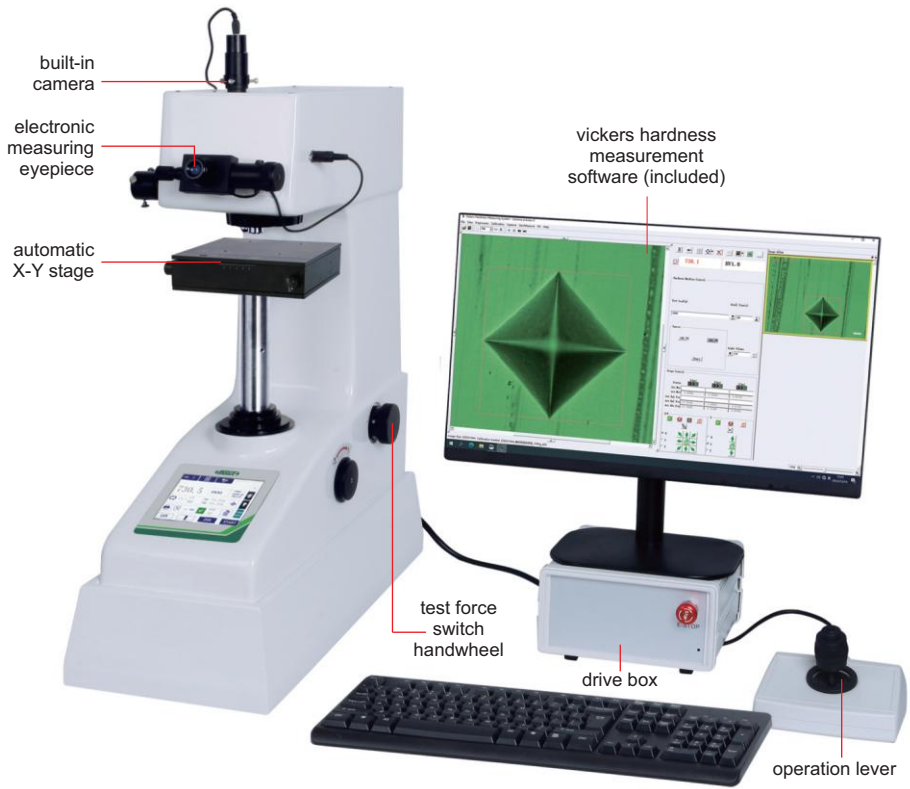

automatic X-Y stage



desk (optional)

HDT-AVH50

- Suitable for vickers hardness determination of various metals and non-metal materials, effective depth and heat affected area measurement, especially suitable for measuring workpieces hardness gradient distribution curve and surface hardness after heat treatment, effective hardening layer depth
- Automatic switch between the indenter and objective lens
- Z-axis automatic focus, X, Y axis automatic movement, can be for multi-point continuous measurement
- Automatic moving table by built-in step motor, high positioning accuracy, good repeatability, fast moving speed, high efficiency
- Automatic moving table bidirectional movement, equipped with safety devices to avoid misoperation
- The software can control the hardness tester hardware operation, two-way communication with each other
- The image acquisition device has fast reaction speed, high automatic measurement accuracy and good repeatability
- The system can automatically generate Word or Excel test report, and the report template can be modified
- According to ISO 6507

27

vickers hardness measurement software (included)

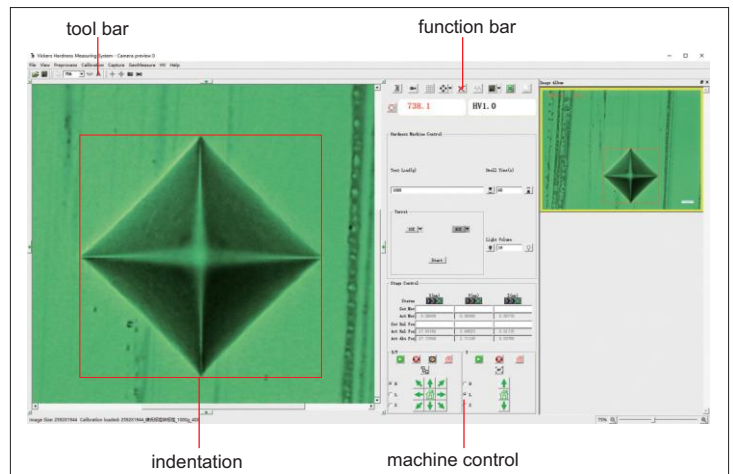

STANDARD DELIVERY

Main unit	1 pc
10X, 20X objective	1 pc of each
Vickers indenter	1 pc
Hardness test block	2 pcs
Automatic X-Y stage drive box	1 pc
Vickers hardness measurement software	1 pc
Computer	1 pc
Anti-dust cover	1 pc

To be continued

Continued from previous page

AUTOMATIC TEST CONTROL SYSTEM

Hardness tester control	1. automatic turret, automatic loading, automatic measurement 2. automatic display of test force, load dwell time, illumination brightness
Automatic control of X-Y stage	software system automatic control of X-Y stage movement
Measurement mode	1. automatic mode: automatic loading, automatic measurement, automatic display of measurement results 2. manual measurement mode can be selected
Automatic measurement	about 0.3sec of one indentation
Measurement repeatability	±1% (700HV/5kgf)
The smallest indentation that can be measured	about 10µm (automatic measurement)
Data output format/edit functions	1. inspection reports can be customized according to customer requirements 2. the depth of hardened layer is shown in table form 3. output various measurement data, hardness table, hardening layer depth, maximum value, average value, minimum value, image with hardness value

AUTOMATIC X-Y STAGE

Drive motor	step motor
Drive control	movement control by software, speed is adjustable
Dimension	110x110mm
Max. travel distance	50x50mm
Min. travel distance	1µm
Movement speed	1~10mm/sec, speed can be adjusted
Displacement repetition accuracy	within 1µm

SPECIFICATION

Code	HDT-AVH05	HDT-AVH10	HDT-AVH30	HDT-AVH50
Test force	0.3kgf, 0.5kgf, 1kgf, 2kgf, 3kgf, 5kgf	0.3kgf, 0.5kgf, 1kgf, 3kgf, 5kgf, 10kgf	1kgf, 3kgf, 5kgf, 10kgf, 20kgf, 30kgf	1kgf, 5kgf, 10kgf, 20kgf, 30kgf, 50kgf
Vickers scales	HV0.3, HV0.5, HV1, HV2, HV3, HV5	HV0.3, HV0.5, HV1, HV3, HV5, HV10	HV1, HV3, HV5, HV10, HV20, HV30	HV1, HV5, HV10, HV20, HV30, HV50
Converted scales	HRA, HRB, HRC, HRD, HRF, HV, HK, HBW, HR15N, HR30N, HR45N, HR15T, HR30T, HR45T			
Range	5~3000HV			
Length measurement resolution	0.01µm			
Objective/indenter switch	motor driven turret			
Stage lifting	manual/electric			
Focus mode	Z-axis autofocus			
Load control	automatic (load/dwell/unload)			
Load dwell time	1~60 second			
Objective	10x, 20X			
Eyepiece	10X			
Total magnification	100X (for measurement or observation), 200X (for measurement)			
Max. workpiece height	160mm			
Max. testing width	130mm (from the center of indenter to the wall of main body)			
Pixel	5M			
Communication interface	RS232			
Power supply	220V, 50/60Hz			
Dimension	630x300x800mm			
Weight	75kg			

OPTIONAL ACCESSORY

Hardness test block	page 875~876
Desk	HDT-DESK
OFFICE software	7313-OFFICE



MOTORIZED DIGITAL BRINELL HARDNESS TESTER (BASIC TYPE) CODE HDT-MBE320

TOUCH
SCREEN

FORCE LOADING BY ELECTRIC
MOTOR (WITHUOT WEIGHT)

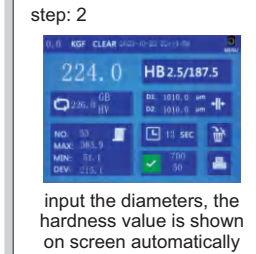
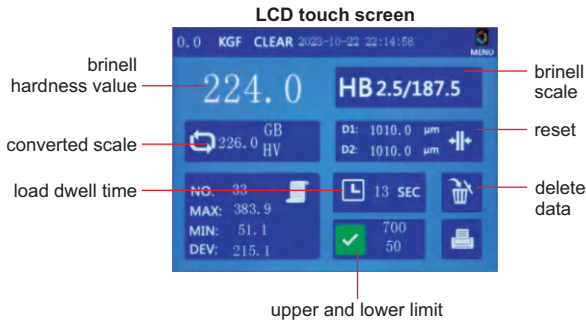

- Touch screen color LCD display
- Measure indentation diameter by measuring microscope, then input the diameters, the hardness value is shown on screen automatically
- Electric loading test force, without weights
- Casting case, structurally stable and not deformed
- According to ISO 6506

SPECIFICATION

Test force	62.5kgf, 100kgf, 125kgf, 187.5kgf, 250kgf, 500kgf, 750kgf, 1000kgf, 1500kgf, 3000kgf	
Brinell scale	HBW2.5/62.5, HBW2.5/187.5, HBW5/62.5, HBW5/125, HBW5/250, HBW5/750, HBW10/100, HBW10/250, HBW10/500, HBW10/1000, HBW10/1500, HBW10/3000	
Range	8~650HBW	
Hardness resolution	0.1HBW	
Stage elevation	manual	
Load control	automatic (load/dwell/unload)	
Load dwell time	0~60 second	
Measuring microscope	magnification	20X
	resolution	0.01mm
Max. workpiece height	230mm	
Max. testing width	140mm (form the center of indenter to the wall of main body)	
Power supply	220V, 50/60Hz	
Dimension	510×210×750mm	
Weight	130kg	



STANDARD DELIVERY

Main unit	1 pc
Ø78mm flat anvil	1 pc
Ø200mm flat anvil	1 pc
V-type anvil	1 pc
Ø2.5mm carbide ball indenter	1 pc
Ø5mm carbide ball indenter	1 pc
Ø10mm carbide ball indenter	1 pc
Hardness test block 100~200HBW2.5/187.5	1 pc
Hardness test block 90~200HBW10/1000	1 pc
Hardness test block 100~200HBW10/3000	1 pc
Measuring microscope	1 pc

OPTIONAL ACCESSORY

Hardness test block 100~200HBW2.5/187.5	HDT-B-HB25A1
Hardness test block 90~200HBW10/1000	HDT-B-HB10C1
Hardness test block 100~200HBW10/3000	HDT-B-HB10A1
Desk	HDT-DESK
Measuring software	HDT-MB□□□

MOTORIZED DIGITAL BRINELL HARDNESS TESTERS (STANDARD TYPE)



TOUCH SCREEN

FORCE LOADING BY ELECTRIC MOTOR (WITHOUT WEIGHT)

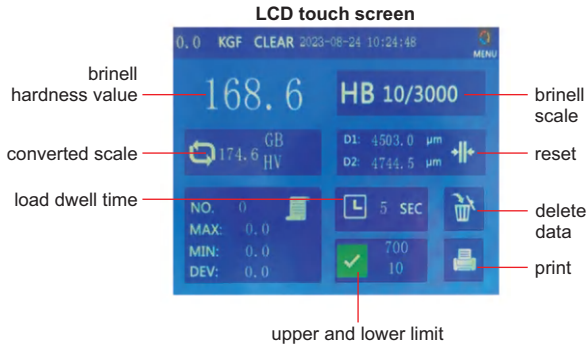

Ø78mm flat anvil (included)



Ø200mm flat anvil (included)



V-type anvil (included)



desk (optional)

- Touch screen color LCD display
- Measure the indentation with microscope, automatically calculate the hardness value and display it on the screen
- Electric loading test force, without weights
- Casting case, structurally stable and not deformed
- According to ISO 6506

SPECIFICATION

Code	HDT-MB610	HDT-MB710
Turret rotation	manual	automatic
Test force	62.5kgf, 100kgf, 125kgf, 187.5kgf, 250kgf, 500kgf, 750kgf, 1000kgf, 1500kgf, 3000kgf	
Brinell scale	HBW2.5/62.5, HBW2.5/187.5, HBW5/125, HBW5/750, HBW10/100, HBW10/250, HBW10/500, HBW10/1000, HBW10/1500, HBW10/3000	
Range	8~650HBW	
Hardness resolution	0.1HBW	
Stage elevation	manual	
Load control	automatic (load/dwell/unload)	
Load dwell time	0~60 second	
Measuring microscope	magnification	20X
	resolution	0.1µm
Max. workpiece height	200mm	
Max. testing width	135mm (form the center of indenter to the wall of main body)	
Data output	built-in printer, RS232	
Power supply	220V, 50/60Hz	
Dimension	510×210×750mm	
Weight	130kg	

STANDARD DELIVERY

Main unit	1 pc
Ø78mm flat anvil	1 pc
Ø200mm flat anvil	1 pc
V-type anvil	1 pc
Ø2.5mm carbide ball indenter	1 pc
Ø5mm carbide ball indenter	1 pc
Ø10mm carbide ball indenter	1 pc
Hardness test block 100~200HBW2.5/187.5	1 pc
Hardness test block 90~200HBW10/1000	1 pc
Hardness test block 100~200HBW10/3000	1 pc

OPTIONAL ACCESSORY

Hardness test block 100~200HBW2.5/187.5	HDT-B-HB25A1
Hardness test block 90~200HBW10/1000	HDT-B-HB10C1
Hardness test block 100~200HBW10/3000	HDT-B-HB10A1
Desk	HDT-DESK
Measuring software	HDT-MB□□□

TOUCH SCREEN

MOTORIZED DIGITAL ROCKWELL/BRINELL/VICKERS HARDNESS TESTER CODE HDT-BRV330

FORCE LOADING BY ELECTRIC MOTOR (WITHUOT WEIGHT)

INSPECTION CERTIFICATE



Ø60mm flat anvil (included)



Ø150mm flat anvil (included)



V-type anvil (included)



- 5.6" color touch LCD display
- Electronic closed-loop control of the applied test force, easy to use, stable display value
- Total of 21 measurement scales, including Brinell, Rockwell and Vickers test method
- Convertible to various hardness standards such as HB, HV, HRC, HK, etc.
- Two types of internal and external illumination are available, and different illumination is used according to the size of the indentation to make the indentation clearer
- Average, maximum and minimum value statistic are available
- Data storage and query function, can be printed out by the printer
- According to ISO 6506, ISO 6507, ISO 6508, ASTM E-10, ASTM E-18, ASTM E-92

Brinell measurement interface

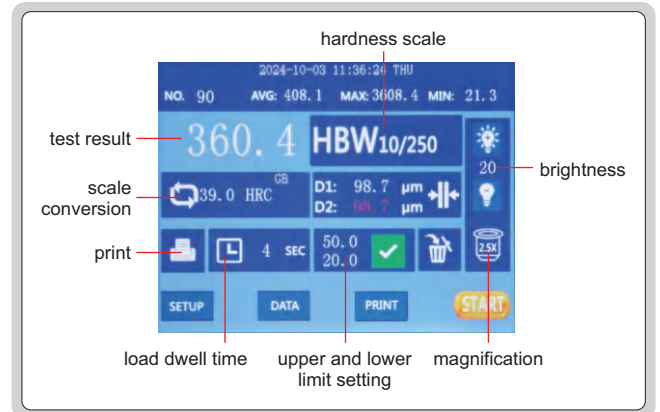

Rockwell measurement interface

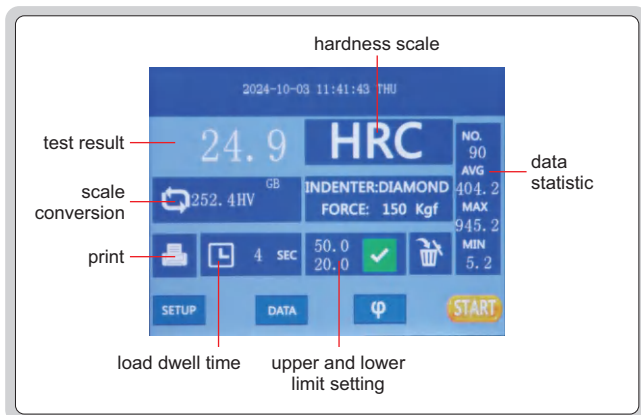

Vickers measurement interface

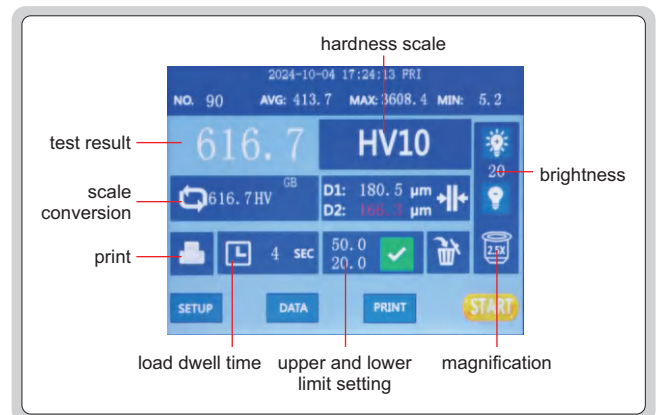

To be continued

Continued from previous page

SPECIFICATION

Type	Brinell	Rockwell	Vickers
Test force	306.5N (31.25kg), 612.9N (62.5kg), 1226N (125kg), 1839N (187.5kg), 980.8N (100kg), 2451.6N (250kg)	588N (60kg), 980N (100kg), 1471N (150kg)	49.03N (5kg), 98.07N (10kg), 196.1N (20kg), 294.2N (30kg), 490.3N (50kg), 980.7N (100kg)
Hardness scale	HBW2.5/31.25, HBW2.5/62.5, HBW2.5/187.5, HBW5/62.5, HBW5/125, HBW5/250, HBW10/100, HBW10/250	HRA, HRB, HRC, HRD, HRF, HRG	HV3, HV5, HV10, HV20, HV30, HV50, HV100
Conversion scale	HRA, HRB, HRC, HRD, HRF, HR15N, HR30N, HR45N, HR15T, HR30T, HR45T, HB, HV, HK		
Range	5-650HBW	20-88HRA, 20-100HRB, 20-70HRC	10-2900HV
Stage lifting	manual		
Load control	automatic (load/dwell/unload)		
Eyepiece	10X		
Objective	2.5X (included, for Brinell), 5X (included, for Vickers), 10X (optional , for Vickers)		
Resolution	0.1HB	0.1HR	0.1HV
Load dwell time	0~99 seconds, can be set		
Max. testing width	160mm		
Max. workpiece height	165mm	180mm	165mm
Power supply	220V, 50/60Hz		
Dimension	550×235×720mm		
Weight	80kg		

STANDARD DELIVERY

Main unit	1 pc
Diamond Rockwell indenter	1 pc
Diamond Vickers indenter	1 pc
Ø2.5mm ball indenter	1 pc
Ø5mm ball indenter	1 pc
Ø1.5875 carbide ball indenter	1 pc
Ø150mm flat anvil	1 pc
Ø60mm flat anvil	1 pc
V-type anvil	1 pc
Skateboard stage	1 pc
Internal lighting bulb	1 pc
External lighting bulb	1 pc
Hardness test block HRC20~30	1 pc
Hardness test block HRC60~70	1 pc
Hardness test block HRB85~100	1 pc
Hardness test block HBW2.5/187.5	1 pc
Hardness test block HV30	1 pc
Anti-dust cover	1 pc

OPTIONAL ACCESSORY

10X objective	HDT-OB-10
Ø10mm ball indenter	HDT-BRV-INDENTER10
Hardness test block 20~30HRC	HDT-B-HRC1
Hardness test block 35~55HRC	HDT-B-HRC2
Hardness test block 60~70HRC	HDT-B-HRC3
Hardness test block 88~100HRB	HDT-B-HRB
Hardness test block 80~84HRA	HDT-B-HRA
Hardness test block 400~500HBW2.5/187.5	HDT-B-HB25A4
Hardness test block 400~500HV5	HDT-B-HV5D



**INSPECTION
CERTIFICATE**

BRINELL/ROCKWELL/VICKERS HARDNESS TESTER CODE ISH-BRV



Ø60mm flat anvil for Rockwell (included)

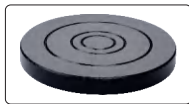

Ø150mm flat anvil for Rockwell (included)



Ø60mm flat anvil for Vickers and Brinell (included)



V-type anvil for Rockwell (included), for cylinders with diameter Ø4~60mm



V-type anvil for Vickers and Brinell (included)



small V-type anvil for Rockwell (optional), for cylinders with diameter Ø2~4mm



desk (optional)



■ According to ISO 6506, ISO 6507, ISO 6508

SPECIFICATION

Rockwell test load	98N preload, 588, 980, 1471N total load
Min. Rockwell reading	0.5HR
Brinell test load	306, 613, 1839N
Vickers test load	294N
Stage elevation	manual
Load control	manual
Magnification of microscope	37.5X/75X
Max. workpiece height	180mm
Max. testing width	200mm (from the center of indenter to the wall of main body)
Power supply	220V, 50/60Hz
Dimension	546×300×767mm
Weight	90kg

STANDARD DELIVERY

Main unit	1 pc
Ø1.5875mm carbide ball indenter	1 pc
Diamond Rockwell indenter	1 pc
Ø5mm Brinell indenter	1 pc
Ø2.5mm Brinell indenter	1 pc
Vickers indenter	1 pc
Ø60mm flat anvil for Rockwell	1 pc
Ø150mm flat anvil for Rockwell	1 pc
V-type anvil for Rockwell	1 pc
Ø60mm flat anvil for Vickers and Brinell	1 pc
V-type anvil for Vickers and Brinell	1 pc
Hardness test block HRB88~95	1 pc
Hardness test block HRC60~65	1 pc
Hardness test block HRC20~30	1 pc
Hardness test block 400~500HV30	1 pc
Hardness test block 180~300HBW2.5/187.5	1 pc
Anti-dust cover	1 pc

OPTIONAL ACCESSORY

Hardness test block HRB88~100	HDT-B-HRB
Hardness test block HRC60~70	HDT-B-HRC3
Hardness test block HRC20~30	HDT-B-HRC1
Hardness test block 400-500HV30	HDT-B-HV30D
Hardness test block 200-300HBW2.5/187.5	HDT-B-HB25A2
Small V-type anvil for Rockwell	ISH-SMALLANVIL
Desk	HDT-DESK

BRINELL INDENTATION AUTOMATIC MEASURING SYSTEMS

AUTOMATIC MEASUREMENT

INSPECTION CERTIFICATE



- Automatic or manual measurement of the indentation diameter and calculation of the corresponding Brinell hardness value
- Automatically calculates statistical values such as mean and variance of measured hardness
- Automatic labeling of abnormal values, automatic alarm when hardness exceeds the specified value
- Measurement data including indentation images can be stored on file
- The system can automatically generate reports in Word or Excel format



HDT-MB325

application



software (included)

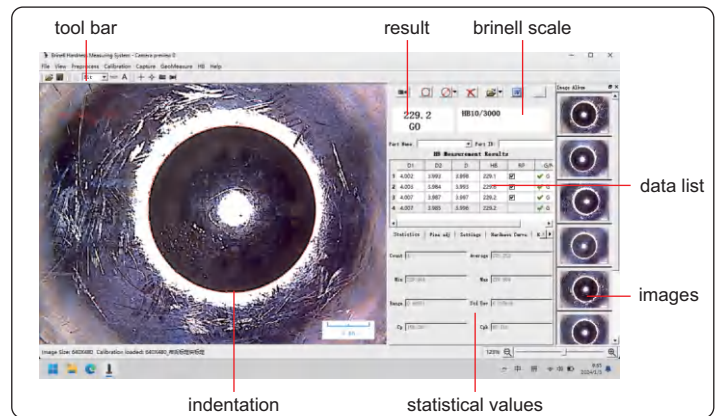

27

SPECIFICATION

Code	HDT-MB325	HDT-MB326
Range of indentation diameter	Ø1~2mm, Ø2~4mm	Ø0.5~1.6mm, Ø3~6mm
Applicable Brinell indenter	Ø2.5mm, Ø5mm, Ø10mm	Ø1mm, Ø2.5mm, Ø5mm, Ø10mm
Diameter measuring accuracy	±0.5%	
Hardness range	15~650HBW	
Camera Pixel	2M	
Dimension	44×40×120mm	
Weight	275g	

STANDARD DELIVERY

Main unit	1 pc
Software	1 pc

OPTIONAL ACCESSORY

OFFICE software	7313-OFFICE
-----------------	-------------

BALANCING BRACKET CODE ISH-BL01



- Suitable for hardness measurement of long strip specimens
- By adjusting the counterweight, to ensure that the indenter is perpendicular to the specimen

SPECIFICATION

Sample diameter	<50mm
Test bench type	V-type anvil
Dimension	600×100×100mm
Weight	5kg

application



JACK LIFTING BRACKET CODE ISH-ST02



- No need to hold the sample, fixing the sample can reduce measurement error

SPECIFICATION

Sample diameter	<50mm
Test bench type	V-type anvil
Adjusting the height	200mm (customizable)
Dimension	250×250×400mm
Weight	11kg

application



ULTRASONIC HARDNESS TESTERS



ATTENTION: NEED TO CONFIRM IF THE WORKPIECES ARE SUITABLE BEFORE PURCHASE

SMALL TEST INDENTATION

ATTENTION: HARDNESS BLOCKS FOR CALIBRATION ARE OPTIONAL

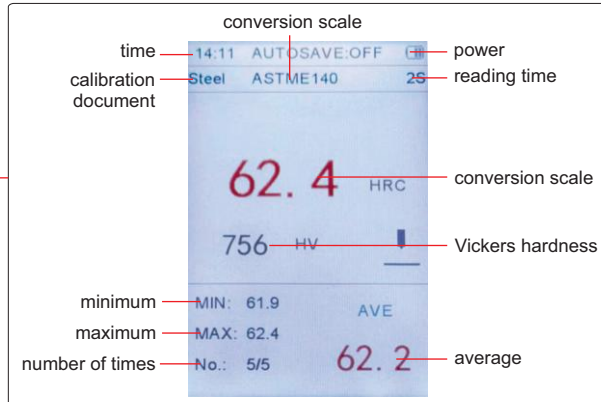

bluetooth printer (included in 9646-301)



stand (optional), suitable for measuring small workpieces, fast and stable

- Small size, light weight, portable, convenient for on-line measurement and can be used to measure large workpieces
- Support 360° measurement, fast test speed, the fastest results in 1 second
- Standard Vickers indentation, small test indentation and low damage to the workpiece
- 100 measurement data sets and 10 calibration data sets can be stored
- Large display, directly shows the current measured value, maximum value, minimum value, average value and unit conversion value
- For unspecified conversion tables and unknown materials, multi-point calibration on any hardness scale you can choose to eliminate of systematic errors due to conversion tables
- According to DIN 50159, ASTM A1038 standards

Applications:

1. Hardness measurement of flange edges and gear root stampings, gears and gear grooves with surface hardening of lamina, taper sections
2. Hardness measurement of shafts and thin-walled pipes and container
3. Hardness measurement of thin plating, wheels, turbine rotors and welded parts
4. Measurement of the depth of a certain diameter deep holes, dents of the larger curvature and convex marks, irregular planes
5. Covering the majority of hardness measurement of industrial production of ferrous metals, non-ferrous metals and their alloys

To be continued

Continued from previous page

SPECIFICATION

Code	9646-300	9646-301
Data printout	without printer	with bluetooth printer
Main test parameter	HV	
Convertible parameters	HRA, HRB, HRC, HBW, HS, MPa	
Measurement range	50-1599HV, 20-68HRC, 85-650HB, 41-100HRB, 61-85.6HRA, 34.2-97.3HS, 255-2180MPa	
Resolution	1HV, 0.1HRA, 0.1HRB, 0.1HRC, 1HB, 0.1HS, 1MPa	
Accuracy	±4%HV, ±4%HB, ±1.5HR	
Calibration method	normal material: one-point calibration special material: multi-point calibration	
Operation temperature	-10°C~40°C	
Power supply	built-in rechargeable lithium battery (for 10 hours working)	
Dimension of main unit	190×82×30mm	
Dimension of probe	150×Ø22mm	
Weight	540g	

STANDARD DELIVERY

Code	9646-300	9646-301
Main unit	1 pc	1 pc
19.6N manual probe	1 pc	1 pc
Bluetooth printer	—	1 pc
Charger	1 pc	1 pc
USB cable	1 pc	1 pc
Randomized standard hardness block	1 pc	1 pc

OPTIONAL ACCESSORY

9.8N manual probe	9646-300-10
29.4N manual probe	9646-300-30
49N manual probe	9646-300-50
98N manual probe	9646-300-98
Hardness test block HRC20~30	HDT-B-HRCU1
Hardness test block HRC35~55	HDT-B-HRCU2
Hardness test block HRC60~70	HDT-B-HRCU3
Hardness test block 200~300HV2	HDT-B-HV2U8
Hardness test block 400~500HV2	HDT-B-HV2U9
Hardness test block 700~750HV2	HDT-B-HV2U10
Hardness test block 90~200HBW10/1000	HDT-B-HB10U1
Hardness test block 200~300HBW10/3000	HDT-B-HB10U2
Hardness test block 400~500HBW10/3000	HDT-B-HB10U3
Stand	9646-300-STAND

SPECIFICATION OF PROBE

Probe type	9.8N (optional)	19.6N (included)	29.4N (optional)	49N (optional)	98N (optional)**
Diameter	22mm	22mm	22mm	22mm	22mm
Length	150mm	150mm	150mm	150mm	150mm
Maximum roughness of measuring surface	Ra<3.2µm	Ra<5µm	Ra<5µm	Ra<10µm	Ra<15µm
Minimum workpiece weight	0.3kg*	0.3kg*	0.3kg*	0.3kg*	0.3kg*
Minimum thickness of workpiece	2mm	2mm	2mm	2mm	2mm
Application	mold shells, fixtures, thin-walled parts, bearings, tooth sides and pipe interiors			measurement of grooves, gear flanks and gear roots	workpieces with low roughness requirement

* If the weight or thickness of workpieces is less than required, the workpieces should be fixed or coupled on solid support

** For large test force, it is recommended to use the probe with a stand

PORTABLE LEEB HARDNESS TESTER APPLICABLE MATERIAL AND HARDNESS RANGE OF IMPACT DEVICE D

Material	HLD	HV	HB	HRC	HRB	HS	Tensile strength (MPa)
Steel & cast steel	300-900	81-955	81-654	20-68	38-100	32-100	375-2639
Tool steel	300-840	80-898		20-67			
Stainless steel	300-800	85-802	85-655		46-101		
Cast iron	360-650		93-334				
Cast aluminum alloy	170-570		19-164		23-84		
Brass	200-550		40-173		13-95		
Bronze	300-700		60-290				
Copper	200-690		45-315				

PORTABLE LEEB HARDNESS TESTERS

BLUETOOTH

DATA OUTPUT

INSPECTION
CERTIFICATE



HDT-CB320
(wired probe is included)



HDT-WL320
(wireless probe is included)

- Can use wired probes or wireless probes
- Dual-coil probe for high accuracy
- Universal testing angle, no need to set impact direction
- Based on Leeb (HLD), converted to Vickers (HV), Brinell (HB), Rockwell (HRC, HRA and HRB), Shore (HS) and tensile strength (σ_b)
- Dual value display, shows both Leeb and converted hardness
- Large 2.4" LCD display with backlight
- With a magnet on the back, the main unit can be attached on steel surfaces
- According to ASTM A956 and DIN 50156



hardness test block D (included)



small support ring (included)

connect to PC, upload the data to PC, print and send to Excel (software is included)



connect to
bluetooth printer (optional)



To be continued

Continued from previous page

SPECIFICATION

Code	HDT-CB320	HDT-WL320
Probe included	wired probe D	wireless probe D
Optional probes	wired (DC/C/D/D+15/DL/E/G), wireless (DC/C/D/DL/G)	
Resolution	1HLD/1HV/1HB/0.1HRC/0.1HRB/0.1HRA/0.1HS/1MPa	
Accuracy	±6HLD (when HLD=800)	
Output	USB	
Measuring range	HL 170-960/HRC 1.3-74.7/HRB 1.2-139.7/HB 28-1027/HV 45-1221 HS 4.0-112.1/HRA 1.3-88.5/MPa 118-3315N/mm ²	
Applicable materials	1. steel/cast steel 2. alloy steel 3. stainless steel 4. gray pig iron 5. nodular cast iron 6. cast aluminum 7. brass 8. bronze 9. copper 10. forging steel 11. rolling steel	
Statistics	average/max./min./s.value	
Memory	999 data	
Working environment	-10°C~45°C	
Power supply	2×AA batteries	
Dimension	145×68×28mm	
Weight	158g	

STANDARD DELIVERY

Code	HDT-CB320	HDT-WL320
Main unit	1 pc	1 pc
Wired probe D	1 pc	—
Wireless probe D	—	1 pc
Hardness test block D	1 pc	1 pc
Small support ring	1 pc	1 pc
Cleaning brush	1 pc	1 pc

OPTIONAL ACCESSORY

Wired probe	DC	HDT-CB320-DC
	C	HDT-CB320-C
	D	HDT-CB320-D
	D+15	HDT-CB320-D15
	DL	HDT-CB320-DL
	E	HDT-CB320-E
	G	HDT-CB320-G
Wireless probe	DC	HDT-WL320-DCW
	C	HDT-WL320-CW
	D	HDT-WL320-DW
	DL	HDT-WL320-DLW
	G	HDT-WL320-GW
Hardness test block D **	HDT-B-HLD3	
Hardness test block G *	HDT-B-HLG2	
Printer	ISH-LP200-PRINTER	
Support rings	page 862	

* Hardness test block G (HDT-B-HLG2) is for probe G (HDT-CB320-G or HDT-WL320-GW)

** Hardness test block D (HDT-B-HLD3) is for all other probes

wired probes (optional)

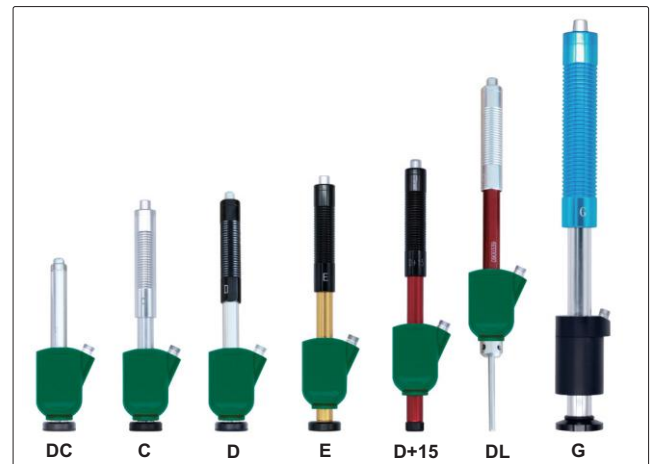

wireless probes (optional)

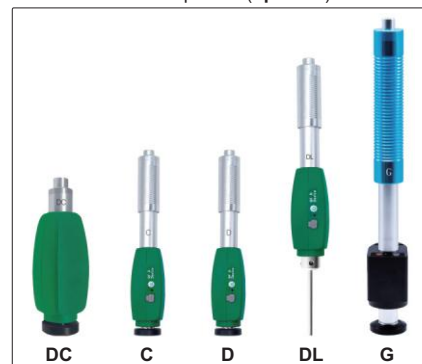

APPLICABLE WORKPIECE

Probes	DC	C	D	D+15	DL	E	G
Application	inner wall of small space	small or thin workpiece, coating layer	general use	deep groove	narrow slot or small hole	very hard material	casting or forging workpiece
Maximum roughness of workpiece (Ra)	2µm	0.4µm	2µm	2µm	2µm	2µm	7µm
Minimum weight of workpiece	direct measurement	5kg	1.5kg	5kg	5kg	5kg	15kg
	on solid support	2.5kg	0.5kg	2kg	2kg	2kg	5kg
	coupled on plate	0.05-2kg	0.02kg	0.05-2kg	0.1kg	0.1kg	0.5kg
Minimum thickness of workpiece	3mm	1mm	3mm	3mm	3mm	3mm	10mm

PORTABLE LEEB HARDNESS TESTER (BUILT-IN BLUETOOTH) CODE ISH-PHB-B

BUILT-IN BLUETOOTH

DATA OUTPUT

- Based on Leeb (HLD), converted to Vickers (HV), Brinell (HB), Rockwell (HRC and HRB), Shore (HS) and tensile strength (MPa)
- Memory of 99 measurement values for browsing
- Set measurement times (1~9) to have average value
- Connected with printer via wireless module
- Automatic power off
- According to ASTM A 956
- Wired data transmission (keyboard signal):
USB cable connect to computer, press transmission button to send data
- Wireless data transmission (keyboard signal):
built-in Bluetooth module connect to computer or mobile phone, press transmission button to send data



INSPECTION
CERTIFICATE



transmission button



hardness test block D (included)



small support ring (included)



wireless printer (optional)

SPECIFICATION

Min. reading	1HLD, 1HV, 1HB, 0.1HRC, 0.1HRB, 1HS, 1MPa	
Accuracy	±6HLD (when HLD=800)	
Display	Leeb (HLD), converted hardness, material, impact direction, test times, average value, date	
Output	bluetooth, USB	
Applicable workpiece	minimum weight	5kg
		2kg (on solid support)
		0.1kg (coupled on plate)
	minimum thickness: 5mm	
minimum radius of curved surface: 30mm		
maximum roughness (Ra): 1.6µm		
Power supply	3×AAA batteries	
Dimension	150×84×28mm	
Weight	200g	

STANDARD DELIVERY

Main unit	1 pc
Impact device D	1 pc
Hardness test block D	1 pc
USB cable	1 pc
Small support ring	1 pc
Cleaning brush	1 pc

OPTIONAL ACCESSORY

Wireless printer	ISH-DS-PRINTER
Couplant	ISH-COULPLANT
Support rings	page 862
Hardness test block D	HDT-B-HLD3

connected to computer by USB cable,
upload the data in real time



connected to computer by bluetooth module,
upload the data in real time





PORTABLE LEEB HARDNESS TESTER WITH WIRELESS PROBE CODE HDT-WP201

- Bluetooth digital probe
- Universal testing angle, no need to set impact direction
- Based on Leeb (HLD), converted to Vickers (HV), Brinell (HB), Rockwell (HRC, HRB), Shore (HSD) and tensile strength (σ_b)
- Dual value display, shows both Leeb and converted hardness
- Large LCD display with backlight
- Can choose large font display and statistics display
- Automatically calculate maximum, minimum and average value
- Save 300 data
- Operation temperature: $-10^{\circ}\text{C}\sim 45^{\circ}\text{C}$
- According to ASTM A956, DIN 50156 GB/T 17394



hardness test block D (included)



small support ring (included)



bluetooth printer (optional)

SPECIFICATION

Resolution	1HLD/1HV/1HB/0.1HRC/0.1HRB/0.1HSD/1 σ_b
Accuracy	$\pm 6\text{HLD}$ (when HLD=800)
Measuring range	HL 170-960/HRC 17-69/HRB 13-101.7/ HB 20-655/HV 80-940/HSD 32-99.5/ σ_b (rm) 255-2180N/mm ²
Power supply	2×AA batteries
Dimension	135×77×32mm
Weight	240g



large font display

statistics display

STANDARD DELIVERY

Main unit	1 pc
Hardness test block D	1 pc
Small support ring	1 pc
Cleaning brush	1 pc
Impact device D	1 pc

OPTIONAL ACCESSORY

Impact device DC	HDT-WL320-DCW
Impact device C	HDT-WL320-CW
Impact device DL	HDT-WL320-DLW
Impact device G	HDT-WL320-GW
Hardness test block D**	HDT-B-HLD3
Hardness test block G*	HDT-B-HLG2
Bluetooth printer	ISH-LP200-PRINTER
Support rings	page 862

* Hardness test block G (HDT-B-HLG2) is for probe G (HDT-WL320-GW)

** Hardness test block D (HDT-B-HLD3) is for all others probes

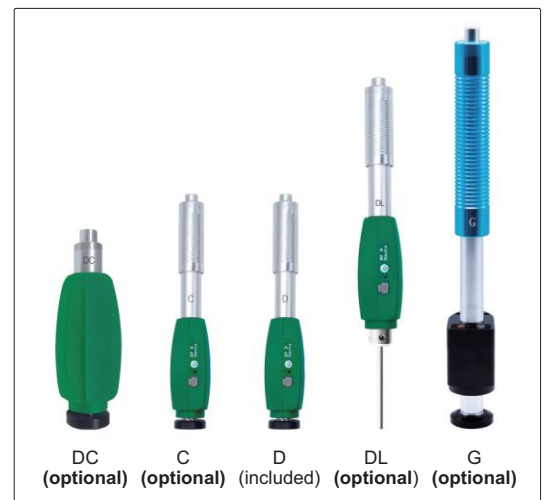

DC (optional) C (optional) D (included) DL (optional) G (optional)

APPLICABLE WORKPIECE

Impact device		DC	C	D	DL	G
Application		inner wall of small space	small or thin workpiece, coating layer	general use	narrow slot or small hole	casting or forging workpiece
Maximum roughness of workpiece (Ra)		2 μm	0.4 μm	2 μm	2 μm	7 μm
Minimum weight of workpiece	direct measurement	5kg	1.5kg	5kg	5kg	15kg
	on solid support	2kg	0.5kg	2kg	2kg	5kg
	coupled on plate	0.05kg	0.02kg	0.05kg	0.05kg	0.5kg
Minimum thickness of workpiece		3mm	1mm	3mm	3mm	10mm

PORTABLE LEEB HARDNESS TESTERS (BASIC TYPE)



- Can change probes
- Dual-coil probe for high accuracy
- Universal testing angle, no need to set impact direction
- Based on Leeb (HLD), converted to Vickers (HV), Brinell (HB), Rockwell (HRC, HRB), Shore (HSD) and tensile strength (σ_b)
- Dual value display, shows both Leeb and converted hardness
- Large LCD display with backlight
- Can choose large font display and statistics display
- Automatically calculate maximum, minimum and average value
- Save 300 data
- Operation temperature: -10°C ~ 45°C
- According to ASTM A956, GB/T 17394

SPECIFICATION

Code	HDT-LP200	HDT-LP200B
Printer	not included	included
Resolution	1HLD/1HV/1HB/0.1HRC/0.1HRB/0.1HSD/1 σ_b	
Accuracy	$\pm 6\text{HLD}$ (when HLD=800)	
Measuring range	HL 170-960/HRC 17-70/HRB 13-109/ HB 20-655/HV 80-940/HSD 32-99.5/ $\sigma_b(\text{rm})$ 255-2639N/mm ²	
Power supply	2×AA batteries	main unit: 2×AA batteries printer: rechargeable lithium battery
Dimension	135×77×32mm	
Weight	240g	

STANDARD DELIVERY

Main unit	1 pc
Hardness test block D	1 pc
Small support ring	1 pc
Cleaning brush	1 pc
Impact device D	1 pc
Bluetooth printer (included in HDT-LP200B)	1 pc

OPTIONAL ACCESSORY

Impact device DC	HDT-LP200-DC
Impact device C	HDT-LP200-C
Impact device D+15	HDT-LP200-D15
Impact device DL	HDT-LP200-DL
Impact device G	HDT-LP200-G
Hardness test block D**	HDT-B-HLD3
Hardness test block G*	HDT-B-HLG2
Support rings	page 862

* Hardness test block G (HDT-B-HLG2) is for impact device G (HDT-LP200-G)

** Hardness test block D (HDT-B-HLD3) is for all other impact devices



HDT-LP200



hardness test block D (included)



small support ring (included)



bluetooth printer (included in HDT-LP200B)



large font display

statistics display

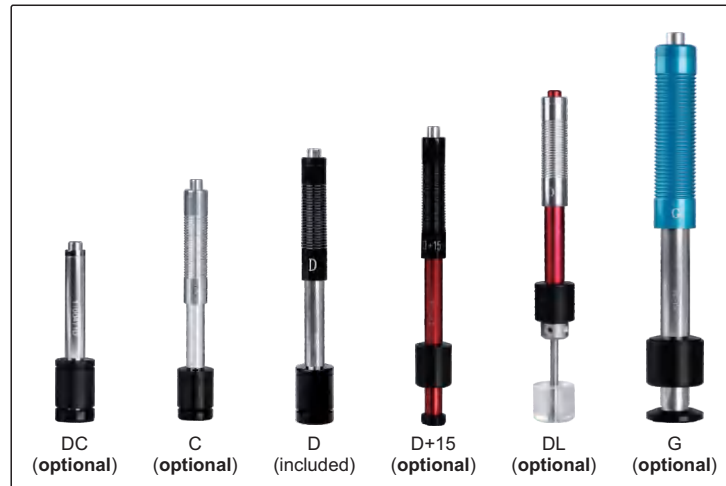

DC (optional) C (optional) D (included) D+15 (optional) DL (optional) G (optional)

APPLICABLE WORKPIECE

Impact device	DC	C	D	D+15	DL	G
Application	inner wall of small space	small or thin workpiece, coating layer	general use	deep groove	narrow slot or small hole	casting or forging workpiece
Maximum roughness of workpiece (Ra)	2 μm	0.4 μm	2 μm	2 μm	2 μm	7 μm
Minimum weight of workpiece	direct measurement	5kg	1.5kg	5kg	5kg	15kg
	on solid support	2kg	0.5kg	2kg	2kg	5kg
	coupled on plate	0.05kg	0.02kg	0.05kg	0.1kg	0.05kg
Minimum thickness of workpiece	3mm	1mm	3mm	3mm	3mm	10mm

DATA OUTPUT

HIGH ACCURACY

DL PROBE IS OPTIONAL

PEN-TYPE LEEB HARDNESS TESTER (ADVANCED TYPE) CODE HDT-L410

INSPECTION CERTIFICATE



- Metal housing
- HD TFT 320×320 display
- Impact device D
- Based on Leeb (HLD), converted to Vickers (HV), Brinell (HB), Rockwell (HRC, HRA and HRB), Shore (HS) and tensile strength (SGM)
- Four display modes
- Automatic direction correction
- Tolerance testing
- Automatic power off, automatic calculation of statistics
- Dual value display, shows both Leeb and other conversion values
- 31 files can be saved, each containing 100 measurement data
- Connected to PC software via USB or Bluetooth 2.0
- Connected with printer via Bluetooth
- Operation temperature: -20°C~70°C
- According to ASTM A956, DIN 50156, GB/T 17394



software flash disk (included)



hardness test block D (included)



wireless printer (optional)



small support ring (included)

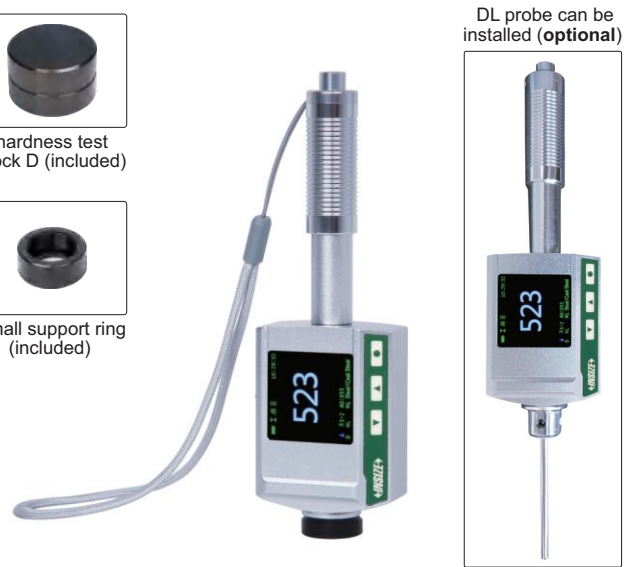

DL probe can be installed (optional)

dynamic ring display

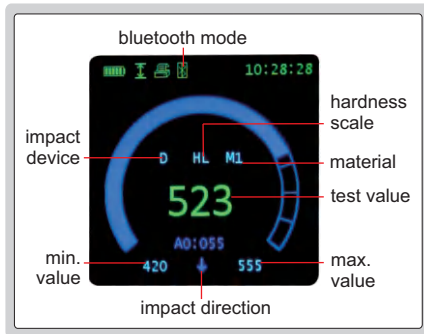

statistic display

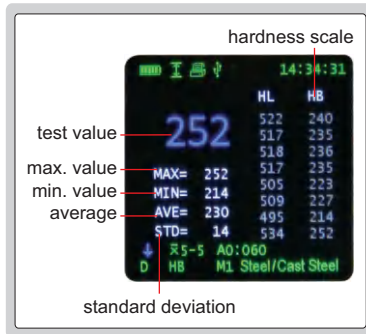

can choose large font display

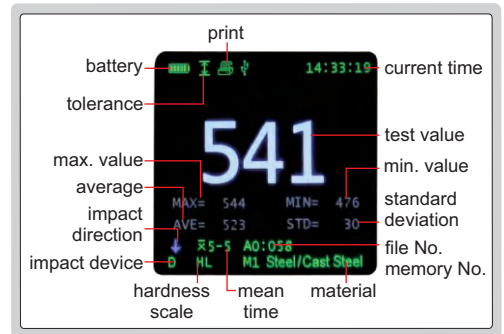

software (included), upload the memory to PC, print and send to EXCEL

upload the memory to PC software via USB cable or Bluetooth

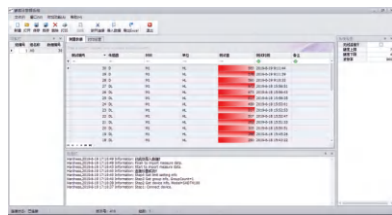

send the stored data to EXCEL

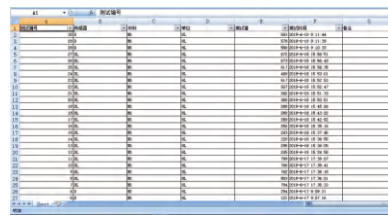

histogram display

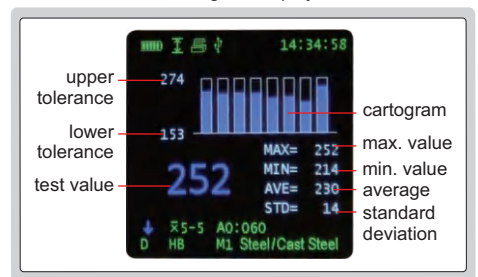

SPECIFICATION

Resolution	1HLD, 1HV, 1HB, 0.1HRC, 0.1HRB, 0.1HRA, 0.1HS, 1SGM	
Accuracy	±4HLD (when HLD=800)	
Output	USB and bluetooth	
Applicable workpiece	minimum weight	5kg (direct measurement)
		2kg (on solid support)
		0.05kg (coupled on plate)
	minimum thickness: 5mm	
minimum radius of curved surface: 30mm		
maximum roughness (Ra): 2µm		
Power supply	built-in 3.7V rechargeable battery	
Dimension	148×44×22mm	
Weight	115g	

STANDARD DELIVERY

Main unit	1 pc
Hardness test block D	1 pc
Small support ring	1 pc
Cleaning brush	1 pc
AC/DC adapter	1 pc
Software flash disk and USB cable	1 pc

OPTIONAL ACCESSORY

Printer	HDT-L410-PRINTER
Support rings	page 862
Hardness test block D	HDT-B-HLD3
DL probe	HDT-L410-DL

PEN-TYPE LEEB HARDNESS TESTER (STANDARD TYPE) CODE HDT-B430

DATA
OUTPUT

DL PROBE IS
OPTIONAL

INSPECTION
CERTIFICATE



software flash disk
(included)



hardness test
block D (included)



small support ring
(included)



wireless printer
(optional)



VIDEO



DL probe can be
installed (optional)



- Impact device D is included
- High contrast OLED display
- Based on Leeb (HLD), converted to Vickers (HV), Brinell (HB), Rockwell (HRC, HRA and HRB), Shore (HS) and tensile strength (σ_b)
- Dual value display, shows both Leeb and other conversion values
- No need to set the testing direction
- 31 files can be saved, each containing 100 measurement data
- Automatically calculate maximum, minimum, average value
- Connected to PC software via USB or Bluetooth
- Connected with printer via Bluetooth
- Operation temperature: -20°C~45°C
- According to ASTM A956, DIN 50156 GB/T, 17394

standard display

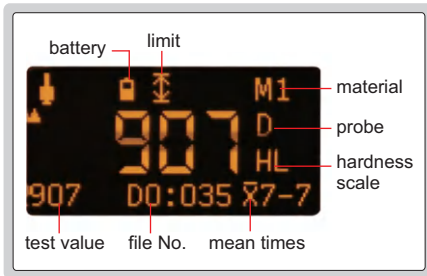

big character display

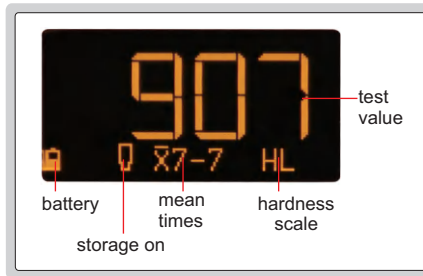

average display

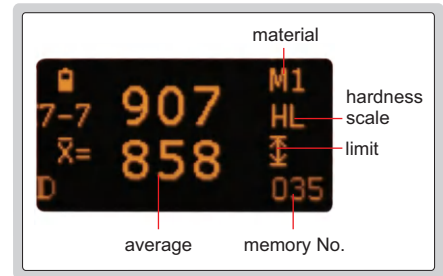

statistical parameter display

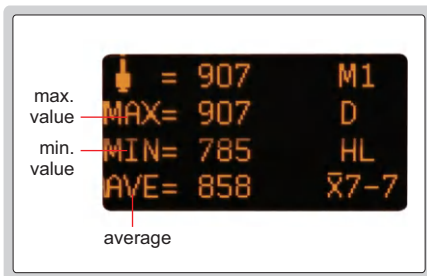

software (included), upload the memory to PC, print and send to EXCEL

upload the memory to PC software
via USB cable or Bluetooth

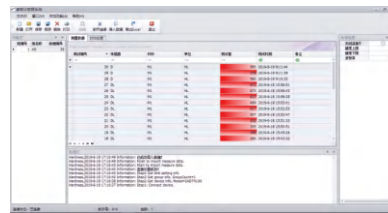

send the stored data to EXCEL

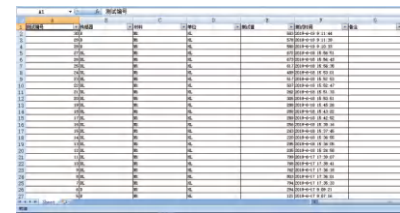

SPECIFICATION

Resolution	1HLD, 1HV, 1HB, 0.1HRC, 0.1HRB, 0.1HRA, 0.1HSD, 16b	
Accuracy	±6HLD (when HLD=800)	
Measuring range	HLD170-960, HRC17-70, HRB13-109, HB20-655, HV80-940 HSD32-99.5, HRA30-88, σ_b (rm) 255-2180N/mm ²	
Applicable workpiece	minimum weight	5kg (direct measurement)
		2kg (on solid support)
		0.05kg (coupled on plate)
	minimum thickness: 5mm	
minimum radius of curved surface: 30mm		
maximum roughness (Ra): 2µm		
Output	USB and bluetooth	
Power supply	built-in 3.7V rechargeable battery	
Dimension	148×44×28mm	
Weight	110g	

STANDARD DELIVERY

Main unit	1 pc
Hardness test block D	1 pc
Small support ring	1 pc
Cleaning brush	1 pc
AC/DC adapter	1 pc
Software flash disk and USB cable	1 pc

OPTIONAL ACCESSORY

Printer	ISH-LP200-PRINTER
Support rings	page 862
Hardness test block D	HDT-B-HLD3
DL probe	HDT-L410-DL

DATA
OUTPUT

INSPECTION
CERTIFICATE

PEN-TYPE LEEB HARDNESS TESTER (BASIC TYPE) CODE HDT-L411



software flash disk
(included)



hardness test
block D (included)



small support ring
(included)



can choose large font display

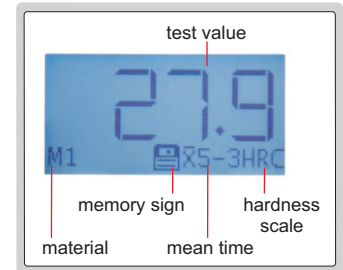

software (included), upload the memory
to PC, print and send to EXCEL

upload the memory to PC
software via USB cable

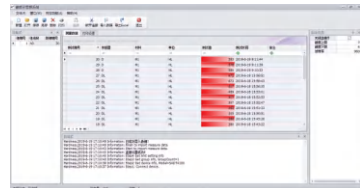

send the stored data to EXCEL

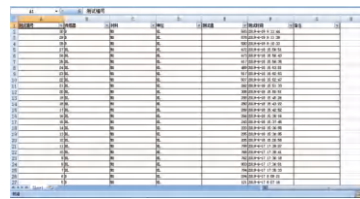

- Impact device D
- Universal testing angle, no need to set impact direction
- Dual-coil probe, high accuracy
- Based on Leeb (HLD), converted to Vickers (HV), Brinell (HB), Rockwell (HRC, HRA and HRB), Shore (HS) and tensile strength (SGM)
- Dual value display, shows both Leeb and converted hardness
- High contrast digital LCD display
- Can choose large font display
- Automatically calculate maximum, minimum, average value
- Connected to PC via USB
- Save 999 data
- Operation temperature: -20°C~45°C
- According to ASTM A956, DIN 50156, GB/T 17394

SPECIFICATION

Resolution	1HLD, 1HV, 1HB, 0.1HRC, 0.1HRB, 0.1HRA, 0.1HS, 1SGM	
Accuracy	±6HLD (when HLD=800)	
Output	USB	
Measuring range	HL100-960, HRC1-74.7, HRB1.2-140, HB28-1027, HV45-1230, HS4-112, HRA7-88.5, SGM (rm) 118-3315N/mm ²	
Applicable workpiece	minimum weight	5kg (direct measurement)
		2kg (on solid support)
		0.05kg (coupled on plate)
	minimum thickness: 5mm	
minimum radius of curved surface: 30mm		
maximum roughness (Ra): 2μm		
Power supply	1×AAA battery	
Dimension	148×45×21mm	
Weight	105g	

STANDARD DELIVERY

Main unit	1 pc
Hardness test block D	1 pc
Cleaning brush	1 pc
AAA battery	1 pc
Small support ring	1 pc
Software flash disk and USB cable	1 pc

OPTIONAL ACCESSORY

Support rings	page 862
Hardness test block D	HDT-B-HLD3

MINI LEEB HARDNESS TESTER CODE HDT-L301

BUILT-IN BLUETOOTH **DATA OUTPUT** **INSPECTION CERTIFICATE**



Mobile App (included)

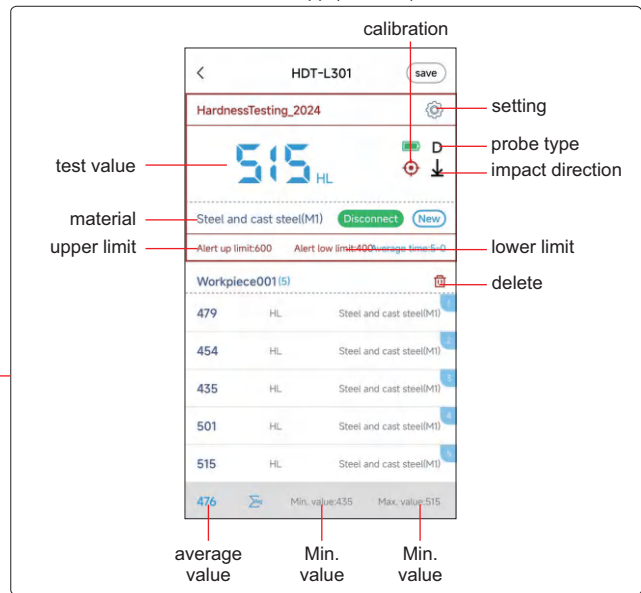

- One-handed operation is possible, making test easier and faster
- Suitable for testing hardness in small space
- All directions test, do not need to set impact direction
- The hardness value can be displayed on hardness tester and the cell phone App at the same time. It can also be connected by computer
- Automatic shutdown
- Support unlimited storage and sharing of test reports
- According to DIN 50156, EN ISO 16859, ASTM A956 standards

dimension of main unit

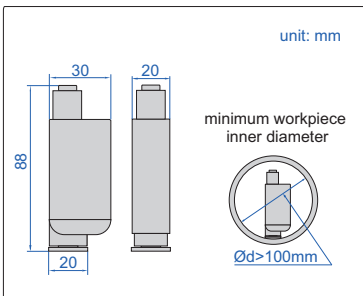

computer software (included)

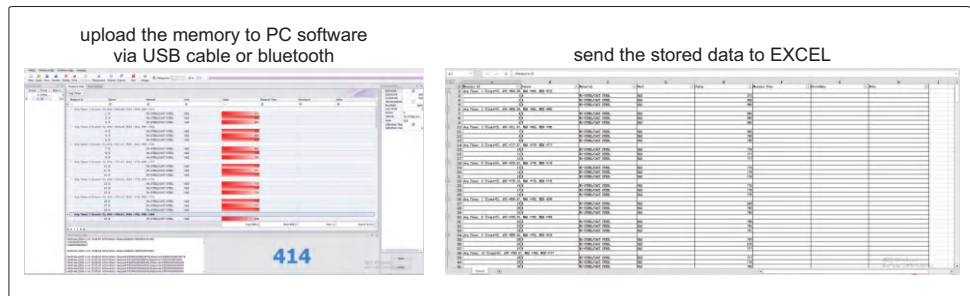

27

SPECIFICATION

Accuracy	±6HLD (when HLD=800)										
Impact device	D										
Hardness scale	HLD, HRA, HRB, HRC, HB, HS, HV, MPa										
Measurement range	170-960HLD, 7-88.5HRA, 1.2-140HRB, 1-74HRC, 18-1027HB, 3.9-112HS, 42-1220HV, 89-3300MPa										
Resolution	1HV, 0.1HRA, 0.1HRB, 0.1HRC, 1HB, 0.1HS, 1MPa										
Applicable material	<table border="0"> <tr> <td>1. steel/cast steel</td> <td>2. alloy tool steel</td> </tr> <tr> <td>3. stainless steel</td> <td>4. grey cast iron</td> </tr> <tr> <td>5. nodular cast iron</td> <td>6. cast aluminium</td> </tr> <tr> <td>7. brass</td> <td>8. bronze</td> </tr> <tr> <td>9. copper</td> <td>10. forged steel</td> </tr> </table>	1. steel/cast steel	2. alloy tool steel	3. stainless steel	4. grey cast iron	5. nodular cast iron	6. cast aluminium	7. brass	8. bronze	9. copper	10. forged steel
1. steel/cast steel	2. alloy tool steel										
3. stainless steel	4. grey cast iron										
5. nodular cast iron	6. cast aluminium										
7. brass	8. bronze										
9. copper	10. forged steel										
Output	USB and bluetooth										
Operation temperature	-20°C~45°C										
Power supply	3.7V Li-ion rechargeable battery										
Dimension	88×30×20mm										
Weight	45g										

STANDARD DELIVERY

Main unit	1 pc
Hardness test block D	1 pc
Support ring	1 pc
Cleaning brush	1 pc
Loading rod	1 pc
Software and USB cable	1 pc



SUPPORT RING SET FOR PORTABLE LEEB HARDNESS TESTER CODE ISH-PH-SP9

type A

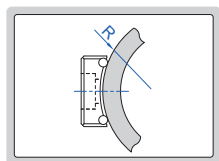
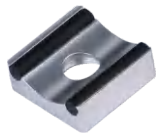

type B

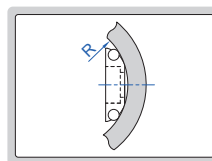
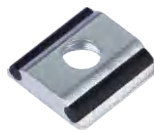

type C

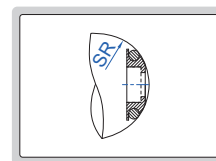

SPECIFICATION

Type	Applicable workpieces	Range (mm)	Quantity
A	cylindrical outside surface	R10-15	3 pcs
		R14.5-30	
		R25-50	
B	cylindrical inside surface	R11-13	3 pcs
		R12.5-17	
		R16.5-30	
C	spherical inside surface	SR11-13	3 pcs
		SR12.5-17	
		SR16.5-30	
D	spherical outside surface	SR10-15	2 pcs
		SR14.5-30	
E	cylindrical outside surface	R>10	1 pc

type D



type E

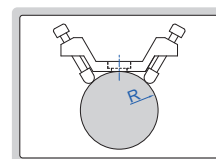
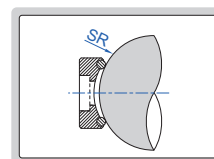

DIGITAL MAGNETIC ROCKWELL HARDNESS TESTER CODE ISHR-D121

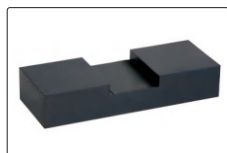

flat anvil for test block
(included)

- Apply to large and heavy steel or iron workpieces
- With statistic function, display average, maximum and minimum values
- Convert to HV, HB and tensile strength
- According to ISO 6508, ASTM E18

SPECIFICATION

Hardness scale	HRA, HRB, HRC
Preliminary test force	10kg
Test force	60kg, 100kg, 150kg
Load control	manual
Min. reading	0.1HR
Flat workpiece requirement	length>190mm, width>60mm, thickness>5mm
Cylinder or tube workpiece requirement	length>200mm, diameter>Ø50mm, wall thickness>8mm
Power supply	3×AA batteries
Dimension	245×105×230mm
Weight	5.3kg



STANDARD DELIVERY

Main unit	1 pc
Flat anvil	1 pc
Diamond indenter	1 pc
Ø1.5875mm carbide ball indenter	1 pc
Hardness test block HRB85~95	1 pc
Hardness test block HRC60~70	1 pc
Hardness test block HRC20~30	1 pc

MAGNETIC ROCKWELL HARDNESS TESTER CODE ISHR-M111



- Apply to large and heavy steel or iron workpieces
- According to ISO 6508, ASTM E18

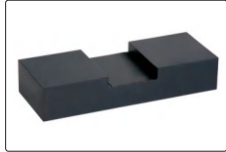

flat anvil for test block
(included)



supports for cylinder or
tube workpieces (included)



magnifier with LED
(included)

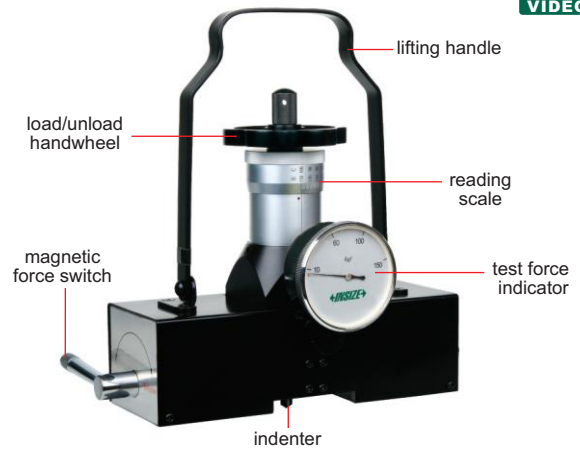

SPECIFICATION

Hardness scale	HRA, HRB, HRC, HRD, HRF, HRG
Preliminary test force	10kg
Test force	60kg, 100kg, 150kg
Load control	manual
Min. reading	1HR
Flat workpiece requirement	length>180mm, width>60mm, thickness>5mm
Cylinder or tube workpiece requirement	length>180mm, diameter>Ø50mm, wall thickness>8mm
Dimension	220×70×220mm
Weight	4.7kg

STANDARD DELIVERY

Main unit	1 pc
Diamond indenter	1 pc
Ø1.5875mm carbide ball indenter	2 pcs
Hardness test block HRB85-95	1 pc
Hardness test block HRC60-70	1 pc
Hardness test block HRC20-30	1 pc
Flat anvil	1 pc
Support	4 pcs
Magnifier with LED	1 pc

MAGNETIC BRINELL/ROCKWELL HARDNESS TESTER CODE ISHR-B141

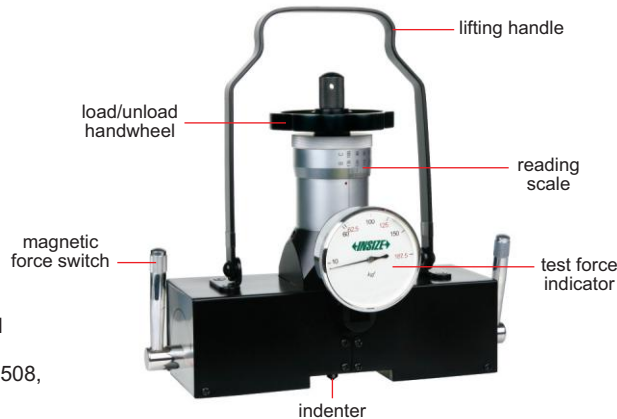

- Apply to large steel or iron workpieces
- According to ISO 6508, ASTM E18

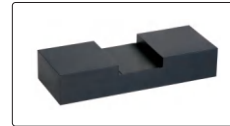

flat anvil for test block
(included)



supports for cylinder or
tube workpieces (included)



magnifier with LED
(included)



measuring microscope
(included)

SPECIFICATION

Rockwell scale	HRA, HRB, HRC, HRD, HRF, HRG
Brinell measuring range	20~650HBW
Rockwell test force	10kg preload, 60kg, 100kg, 150kg total load
Brinell test force	62.5kg, 125kg, 187.5kg
Load control	manual
Min. Rockwell reading	1HR
Measuring microscope	40X, graduation 0.01mm
Flat workpiece requirement	length>180mm, width>60mm, thickness>5mm
Cylinder and tube workpiece requirement	length>180mm, diameter>Ø50mm, thickness>8mm
Dimension	220×70×220mm
Weight	4.7kg

STANDARD DELIVERY

Main unit	1 pc
Flat anvil	1 pc
Support	4 pcs
Diamond Rockwell indenter	1 pc
Ø1.5875mm carbide ball indenter	1 pc
Ø2.5mm Brinell indenter	1 pc
Hardness test block HRB85-95	1 pc
Hardness test block HRC60-70	1 pc
Hardness test block HRC20-30	1 pc
Brinell test block	1 pc
Measuring microscope	1 pc
Magnifier with LED	1 pc

PORTABLE BRINELL AND ROCKWELL HARDNESS TESTER CODE ISBR-H181



- Apply to huge or medium-size workpieces
- According to ISO 6506, ISO 6508, ASTM E10, ASTM E18

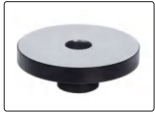

flat anvil
(included)



V-type anvil
(included)



measuring
microscope
(included)

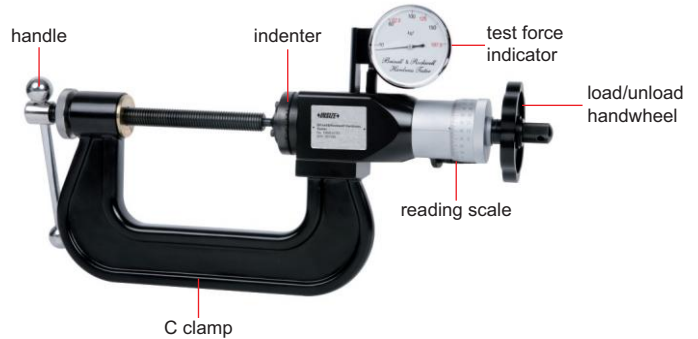

SPECIFICATION

Rockwell hardness scale	HRA, HRB, HRC
Brinell test range	16~650HBW
Rockwell preliminary test force	10kgf
Rockwell total test force	60kgf, 100kgf, 150kgf
Brinell test force	62.5kgf, 125kgf, 187.5kgf
Load control	manual
Min. reading	rockwell 0.5HR brinell 0.005mm (indentation diameter)
Max. workpiece thickness	75mm
Max. testing width	100mm (from the center of indenter to the main body)
Dimension	510×380×180mm
Weight	2.3kg

STANDARD DELIVERY

Main unit	1 pc
Diamond indenter	1 pc
Ø1.5875mm carbide ball indenter	1 pc
Ø2.5mm carbide ball indenter	1 pc
Ø5mm carbide ball indenter	1 pc
Hardness test block HRB88~95	1 pc
Hardness test block HRC20~30	1 pc
Hardness test block HRC60~65	1 pc
Hardness test block 200~300HBW2.5/187.5	1 pc
Flat anvil	1 pc
V-type anvil	1 pc
Measuring microscope	1 pc



PORTABLE ROCKWELL HARDNESS TESTER CODE ISHR-P151



anvil extension for thin
workpieces (included)



flat anvil (included)



V-type anvil (included)

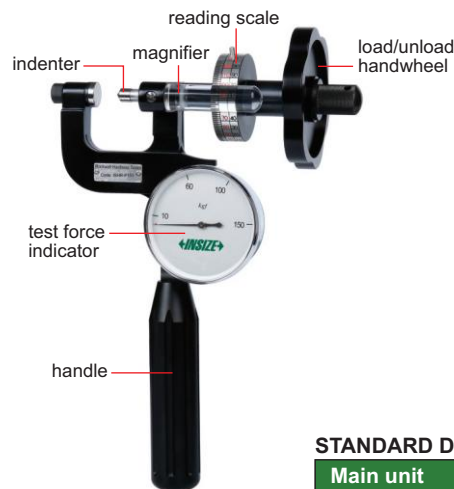

base
(included)

- According to ISO 6508, ASTM E18

SPECIFICATION

Hardness scale	HRA, HRB, HRC, HRD, HRF, HRG
Preliminary test force	10kg
Test force	60kg, 100kg, 150kg
Load control	manual
Min. reading	1HR
Max. workpiece thickness	25mm
Max. testing width	25mm (from the center of indenter to the main body)
Dimension	240×70×160mm
Weight (with base)	2.5kg

STANDARD DELIVERY

Main unit	1 pc
Diamond indenter	1 pc
Ø1.5875mm carbide ball indenter	2 pcs
Hardness test block HRB88~95	1 pc
Hardness test block HRC60~65	1 pc
Hardness test block HRC20~30	1 pc
Flat anvil	1 pc
V-type anvil	1 pc
Base	1 pc
Anvil extension	1 pc
Magnifier	2 pcs

PIN BRINELL HARDNESS TESTER CODE ISHB-P101



- Measure Brinell hardness of large and heavy workpieces
- 1580kg test force and Ø7.26mm ball indenter, equal to 3000kg test force and Ø10mm ball indenter
- Static and impact test modes
- According to ISO and ASTM standard

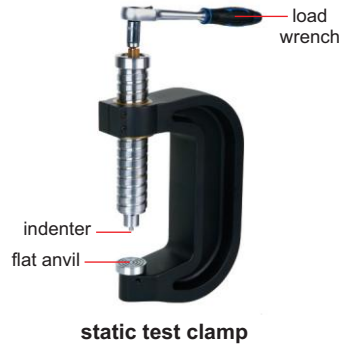

static test clamp

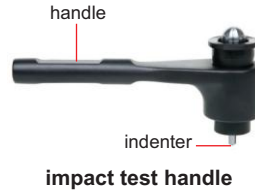

impact test handle

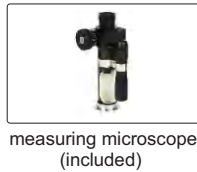
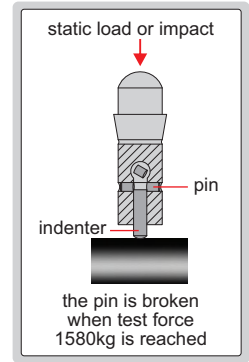

measuring microscope (included)

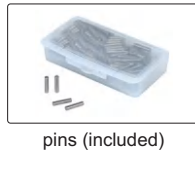

pins (included)

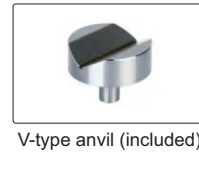

V-type anvil (included)

SPECIFICATION

Measuring range	100~350HBW (with Ø7.26mm indenter, included) 350~650HBW (with Ø4mm indenter, optional)
Test force	1580kg
Accuracy	static test: ±3% impact test: ±5%
Measuring microscope	20X, graduation 0.01mm
Max. workpiece height of static test	150mm
Max. testing width of static test	80mm (from the center of indenter to the clamp)
Dimension	195×60×350mm
Weight	4.2kg

STANDARD DELIVERY

Static test clamp	1 pc
Impact test handle	1 pc
Flat anvil	1 pc
V-type anvil	1 pc
Ø7.26mm indenter	1 pc
Hardness test block	1 pc
Pin	250 pcs
Measuring microscope	1 pc

OPTIONAL ACCESSORY

Ø4mm indenter	ISHB-P101-INDENTER
Pin (250 pcs)	ISHB-P101-PIN

HAMMER IMPACT BRINELL HARDNESS TESTER CODE HDT-PB350

27

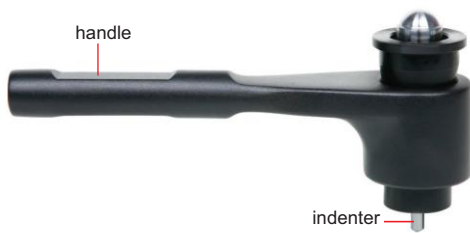

hammer impact to apply test force

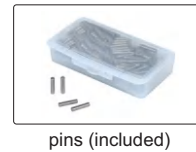

pins (included)



measuring microscope (included)

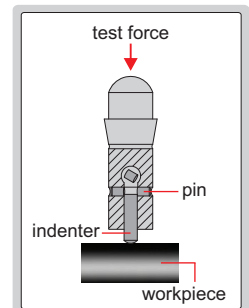

the pin is broken when test force 1580kg is reached

- Measure Brinell hardness of large and heavy workpieces
- 1580kg test force and Ø7.26mm ball indenter, equal to 3000kg test force and Ø10mm ball indenter

SPECIFICATION

Measuring range	100~350HBW (with Ø7.26mm indenter, included) 350~650HBW (with Ø4mm indenter, optional)
Test force	1580kg
Accuracy	±5%HBW
Repeatability	±5%HBW
Measuring microscope	20X, graduation 0.01mm
Dimension	200×50×100mm
Weight	0.8kg

STANDARD DELIVERY

Main unit	1 pc
Ø7.26mm indenter	1 pc
Hardness test block	1 pc
Pin	250 pcs
Pin removal tool	1 pc
Measuring microscope	1 pc

OPTIONAL ACCESSORY

Ø4mm indenter	ISHB-P101-INDENTER
Pin (250 pcs)	ISHB-P101-PIN



V-type anvil
(included)



spherical anvil
(included)



measuring microscope
(included)

- According to ISO 6506, ASTM E10

SPECIFICATION

Measuring range	16~650HBW
Test force	3000kg
Indenter	Ø10mm carbide ball
Measuring microscope	20X, graduation 0.01mm
Max. workpiece height	350mm
Max. testing width	90mm (from the center of indenter to the column)
Dimension	270×225×570mm
Weight	13.8kg

STANDARD DELIVERY

Main unit	1 pc
Flat anvil	1 pc
V-type anvil	1 pc
Spherical anvil	1 pc
Ø10mm carbide ball	2 pcs
Brinell test block	2 pcs
Measuring microscope	1 pc

HYDRAULIC BRINELL HARDNESS TESTER CODE ISHB-H131

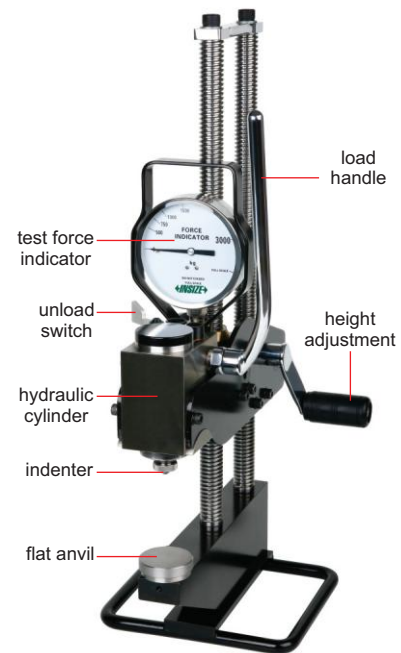

CHAIN TYPE HYDRAULIC BRINELL HARDNESS TESTER CODE ISHB-C161

- To measure the hardness of cylinders or tubes
- According to ISO 6506, ASTM E10

SPECIFICATION

Measuring range	32~650HBW
Workpiece diameter range	Ø150~Ø500mm
Test force	3000kg
Indenter	Ø10mm carbide ball
Measuring microscope	20X, graduation 0.01mm
Dimension	270×225×570mm
Weight	14.5kg

STANDARD DELIVERY

Main unit	1 pc
1.5m chain	1 pc
Ø10mm carbide ball	2 pcs
Brinell test block	2 pcs
Measuring microscope	1 pc

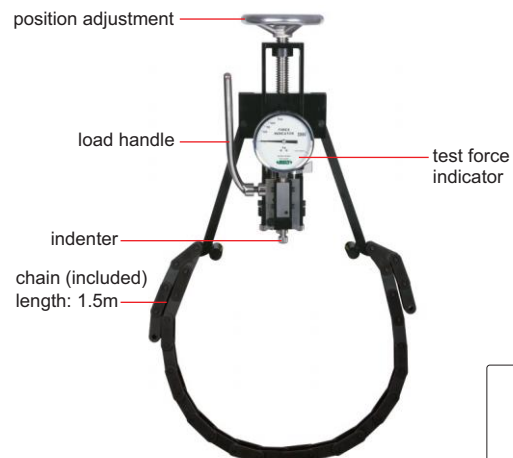

measuring microscope
(included)

ALUMINUM HARDNESS TESTERS



- To measure the hardness of soft metals such as aluminum alloy, copper, brass, soft steel, etc.
- According to ASTM B647-84 (2000)

SPECIFICATION

Code	ISHW-L20	ISHW-L20A	ISHW-L20B	ISHW-B70	ISHW-B75	ISHW-B92
Application	for aluminum alloy general use	for aluminum alloy thick workpiece	for aluminum alloy small tube	for hard aluminum alloy and hard brass	for soft brass and copper	for soft steel and cold-rolled steel
Thickness requirement of flat workpiece	0.6~6mm	0.6~13mm	0.6~8mm	0.6~6mm	0.6~6mm	0.6~6mm
Internal diameter requirement of tube workpiece	>Ø10mm	>Ø10mm	>Ø6mm	>Ø10mm	>Ø10mm	>Ø10mm
Wall thickness requirement of tube workpiece	0.6~6mm	6~13mm (internal diameter Ø10~23.3mm) 0.6~6mm (internal diameter >Ø23.3mm)	0.6~8mm	0.6~6mm	0.6~6mm	0.6~6mm
Hardness range	0~20HW					
Min. reading	1HW					
Accuracy	±0.5HW (at 5~17HW)					
Dimension	205×30×85mm					
Weight	500g					

STANDARD DELIVERY

Main unit	1 pc
Spare indenter	1 pc
Hardness test block	1 pc
Wrench	1 pc

ALUMINUM HARDNESS TESTERS (BASIC TYPE)



- To measure the hardness of soft metals such as aluminum alloy, copper, brass, soft steel, etc.
- According to ASTM B647-10 (2016)

STANDARD DELIVERY

Main unit	1 pc
Spare indenter	1 pc
Hardness test block	1 pc
Wrench	1 pc



SPECIFICATION

Code	ISHW-H10	ISHW-H11	ISHW-H12	ISHW-H13	ISHW-H14	ISHW-H15
Application	for aluminum alloy general use	for aluminum alloy thick workpiece	for aluminum alloy small tube	for hard aluminum alloy and hard brass	for soft brass and copper	for soft steel and cold-rolled steel
Thickness requirement of flat workpiece	0.6~6mm	0.6~13mm	0.6~8mm	0.6~6mm	0.6~6mm	0.6~6mm
Internal diameter requirement of tube workpiece	>Ø10mm	>Ø10mm	>Ø6mm	>Ø10mm	>Ø10mm	>Ø10mm
Wall thickness requirement of tube workpiece	0.6~6mm	6~13mm (internal diameter Ø10~23.3mm) 0.6~6mm (internal diameter >Ø23.3mm)	0.6~8mm	0.6~6mm	0.6~6mm	0.6~6mm
Hardness range	0~20HW					
Min. reading	1HW					
Accuracy	±0.5HW (at 5~17HW)					
Dimension	205×30×95mm					
Weight	500g					

- To measure the hardness of soft metals such as aluminum profiles, tubes, plates, aluminum parts and other soft metals
- Easy to read, with peak hold function
- According to ASTM B647-2023



DIGITAL ALUMINUM HARDNESS TESTERS

SPECIFICATION

Code	ISHW-D20	ISHW-D21	ISHW-D22
Application	for aluminum alloy general use	for aluminum alloy thick workpieces	for aluminum alloy small tubes
Thickness requirement of flat workpieces	1~6mm	1~13mm	1~6mm
Internal diameter requirement of tube workpieces	>Ø10mm	>Ø10mm	>Ø6mm
Wall thickness requirement of tube workpieces	1~6mm	6~13mm (internal diameter Ø10mm~24mm) 1~6mm (internal diameter >Ø24mm)	1~6mm
Hardness range	0~20HW		
Min. reading	0.1HW		
Accuracy	±0.5HW (at 5~18HW)		
Dimension	203×44×105mm		
Weight	500g		



STANDARD DELIVERY

Main unit	1 pc
Spare indenter	1 pc
Hardness test block	1 pc
Wrench	1 pc
Lithium battery	2 pcs
Lithium battery charger	1 pc

ALUMINUM HARDNESS TESTER CODE ISHB-B300



- To measure the hardness of workpieces made of pure aluminum, aluminum alloy, fiber reinforced plastic, hard plastic, etc.
- According to ASTM B648-00, ASTM D2853-07

SPECIFICATION

Hardness range	0~100HBa
Effective range	35~90HBa (equal to 25~150HBW)
Min. reading	1HBa
Accuracy	±2HBa (at 42~52HBa) ±1HBa (at 84~88HBa)
Min. workpiece thickness	0.8mm
Dimension	142×65×90mm
Weight	500g



STANDARD DELIVERY

Main unit	1 pc
Spare indenter	2 pcs
Hardness test block	2 pcs
Wrench	1 pc

DIGITAL ALUMINUM HARDNESS TESTER CODE HDT-DB337



27

- To measure the hardness of workpieces made of pure aluminum, aluminum alloy, fiber reinforced plastic, hard plastic, etc.
- The support can be rotated, no need to disassemble
- Can be converted to HW, HRE, HRF, HV, HB values
- Full scale one key reset, no need to disassemble for external calibration
- According to ASTM B648, ASTM HD2583-2007

SPECIFICATION

Hardness range	0~100HBa
Effective range	40~90HBa (equal to 25~135HBW)
Min. reading	0.1HBa
Accuracy	±2HBa (at 42~52HBa) ±1HBa (at 84~88HBa)
Repeatability	±2.5HBa (at 42~52HBa) ±1.5HBa (at 84~88HBa)
Min. workpiece thickness	1.5mm
Dimension	143×40×87mm
Weight	260g



STANDARD DELIVERY

Main unit	1 pc
Full scale calibration block	1 pc
Hardness test block	2 pcs
Spare pin	1 pc
Wrench	1 pc
Power adapter	1 pc



DIGITAL SHORE DUROMETERS

- With time hold function, the time can be set from 0 to 30 seconds
- 1.5 inch OLED display
- Meet the requirements of force measurement forward and reverse in the verification regulations
- Digital displacement sensor, high test accuracy
- Zero point calibration function, calibration block is not required
- With average function, to have average values from 0 to 9 times
- Can be used with test stand (optional) for high accuracy and stable measurement
- According to ISO 48, ISO 7619, ISO 21509



SPECIFICATION

Code	HDT-ESA	HDT-ESD
Unit	shore A	shore D
Test material	medium hardness vulcanized rubber and thermoplastic rubber, etc.	high hardness vulcanized rubber and thermoplastic rubber, etc.
Measuring range	0~100HA *	0~100HD *
Resolution	0.2HA	0.2HD
Accuracy	±1HA	±1HD
Indenter protrusion	2.5mm	
Output	USB	
Power supply	built-in rechargeable battery	
Dimension	150×60×50mm	
Weight	300g	

* Use HDT-ESD when measuring result is higher than 90HA
use HDT-ESA when measuring result is lower than 20HD

STANDARD DELIVERY

Main unit	1 pc
Software and USB cable	1 pc
Power adapter	1 pc

OPTIONAL ACCESSORY

Test stand for digital shore durometers	HDT-ES-STD
---	------------

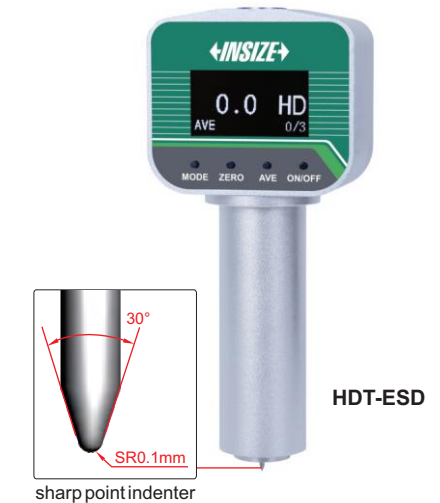

TEST STAND FOR DIGITAL SHORE DUROMETERS CODE HDT-ES-STD

- For digital shore durometers HDT-ESA and HDT-ESD
- Perform repeatable hardness measurement due to fewer possibilities of human error or measurement variations
- Special structure for stable loading
- Weight block A (included) is for HDT-ESA
weight block D (optional) is for HDT-ESD

SPECIFICATION

Stage diameter	Ø95mm
Max. workpiece height	90mm
Max. testing width	55mm (from test point to the column)
Dimension	200×160×440mm
Weight	13kg

STANDARD DELIVERY

Test stand	1 pc
Weight block A (for HDT-ESA)	1 pc



weight block D (optional)
for HDT-ESD

OPTIONAL ACCESSORY

Weight block D (for HDT-ESD)	HDT-ES-W5
------------------------------	-----------

DIGITAL SHORE DUROMETERS



- According to ISO868, ISO7619, ASTM D 2240
- Average and peak (max.) mode
- Dwell time is adjustable
- Tolerance testing
- 500 memories
- Wireless connection to printer
- Handhold use or work with test stand (code ISH-DS-STANDA)
- Automatic power off



software flash disk (included)



calibration block (included)



printer (optional)

27

SPECIFICATION

Code	ISH-DSA	ISH-DSD	ISH-DSOO
Unit	Shore A	Shore D	Shore OO
Test material	soft plastic, soft rubber, etc.	hard plastic, hard rubber, etc.	very soft plastic, rubber, sponge, textile, etc.
Measuring range	0~100HA *	0~100HD *	0~100HOO
Resolution	0.1HA	0.1HD	0.1HOO
Accuracy	±1HA	±1HD	±1HOO
Indenter protrusion	2.5mm		
Output	wireless and USB		
Power supply	built-in rechargeable battery		
Dimension	153×50×29mm		
Weight	170g		

* Use ISH-DSD when measuring result is higher than 90HA
Use ISH-DSA when measuring result is lower than 20HD

STANDARD DELIVERY

Main unit	1 pc
Calibration block	1 pc
Software and USB cable	1 pc
AC/DC adapter	1 pc

OPTIONAL ACCESSORY

Printer	ISH-DS-PRINTER
Test stand	ISH-DS-STANDA



TEST STAND FOR DIGITAL SHORE DUROMETERS CODE ISH-DS-STANDA

- For digital shore durometers (code **ISH-DSA**, **ISH-DSD** and **ISH-DSOO**)
- Perform repeatable hardness measurement due to fewer possibilities of human error or measurement variations
- Special structure for stable loading
- Weight block A (included) is for **ISH-DSA**, weight block D (optional) is for **ISH-DSD**, remove weight block for **ISH-DSOO**



weight block D (optional) for ISH-DSD



SPECIFICATION

Stage diameter	Ø115mm
Max. workpiece height	45mm
Max. testing width	63mm (from test point to the column)
Dimension	Ø195×370mm
Weight	5.61kg

STANDARD DELIVERY

Test stand	1 pc
Weight block A (for ISH-DSA)	1 pc

OPTIONAL ACCESSORY

Weight block D (for ISH-DSD)	ISH-DS-W4
------------------------------	-----------



SHORE DUROMETERS

INSIZE PLUS
MADE IN EUROPE

- According to ISO868, ISO7619, ASTM D 2240
- With peak value indicator
- Handhold use or work with test stand (code **ISH-OS2**)

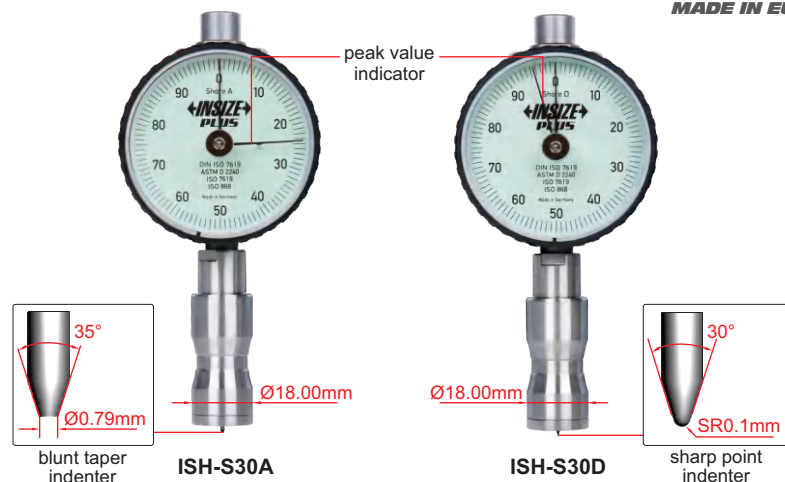

SPECIFICATION

Code	ISH-S30A	ISH-S30D
Scale	Shore A	Shore D
Test material	soft plastic, soft rubber, etc.	hard plastic, hard rubber, etc.
Measuring range *	0~100HA	0~100HD
Graduation	1HA	1HD
Accuracy	±0.5HA	±0.5HD
Indenter protrusion	2.5mm	
Weight	184g	

* Use **ISH-S30D** when measuring result is higher than 90HA
Use **ISH-S30A** when measuring result is lower than 20HD

TEST STAND FOR SHORE DUROMETERS CODE ISH-OS2

INSIZE PLUS
MADE IN EUROPE



- For shore durometers (code **ISH-S30A** and **ISH-S30D**)
- Perform repeatable hardness measurement due to fewer possibilities of human error or measurement variations
- Special structure for stable loading
- 1kg weight block (included) is for **ISH-S30A**, 4kg weight block (optional) is for **ISH-S30D**

SPECIFICATION

Stage diameter	Ø98mm
Max. workpiece height	180mm
Max. testing width	115mm (from test point to the column)
Dimension	Ø200×500mm
Weight	18kg

STANDARD DELIVERY

Test stand	1 pc
1kg weight block (for ISH-S30A)	1 pc
Calibration block	1 pc

OPTIONAL ACCESSORY

4kg weight block (for ISH-S30D)	ISH-OS2-W4
---------------------------------	------------

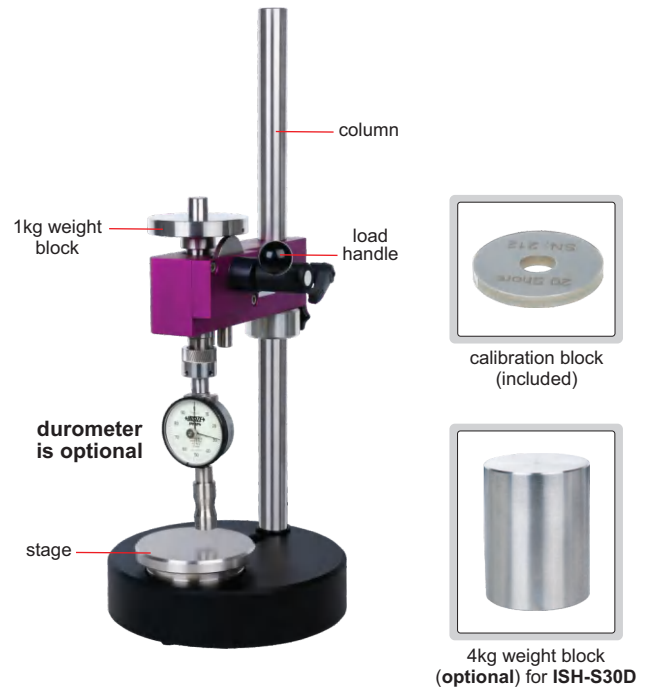

SHORE DUROMETERS

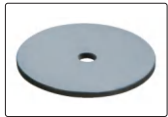

calibration block (optional)



27

- According to ISO868, ISO7619, ASTM D 2240
- With peak value indicator
- Optional accessory: test stand **ISH-STAC** and **ISH-STD**

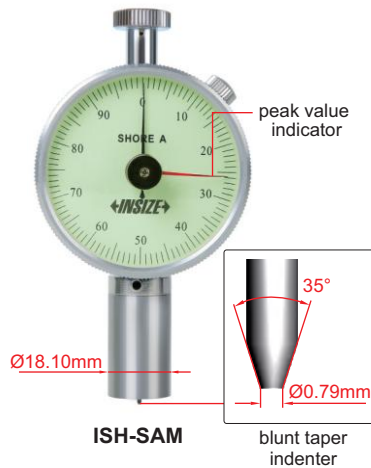

ISH-SAM

blunt taper indenter

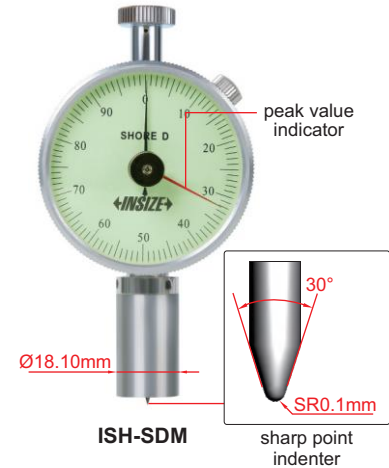

ISH-SDM

sharp point indenter

SPECIFICATION

Code	ISH-SAM	ISH-SDM
Scale	Shore A	Shore D
Application	nature rubber, soft elastomer, etc.	hard rubber, plastic, hard elastomer, etc.
Measuring range *	10~90HA	20~90HD
Graduation	1HA	1HD
Indenter protrusion	2.5mm	
Dimension	115×60×25mm	
Weight	160g	

* Use **ISH-SDM** when measuring result is higher than 90HA
Use **ISH-SAM** when measuring result is lower than 20HD

OPTIONAL ACCESSORY

Calibration block	ISH-DS-BLOCK
-------------------	--------------



TEST STANDS FOR SHORE DUROMETERS

- For shore durometers (code **ISH-SAM** and **ISH-SDM**)
- Perform repeatable hardness measurement due to fewer possibilities of human error or measurement variations

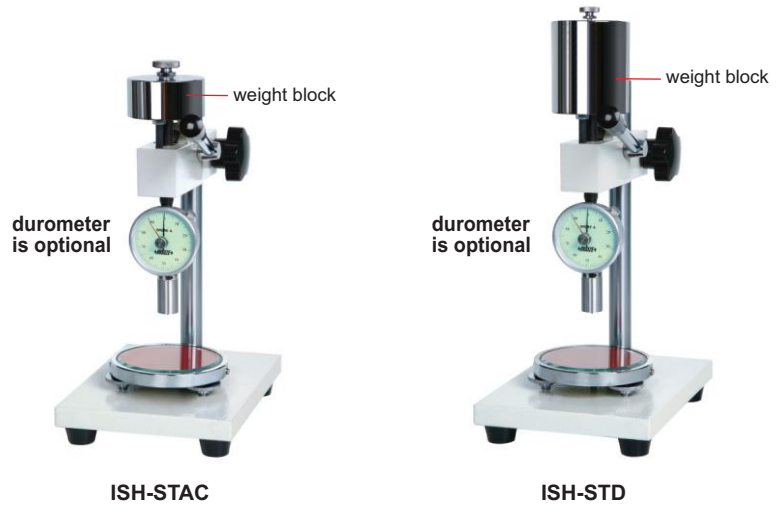

SPECIFICATION

Code	ISH-STAC	ISH-STD
Applicable durometer	ISH-SAM	ISH-SDM
Stage diameter	Ø100mm	Ø100mm
Max. workpiece height	75mm	75mm
Max. testing width	65mm (from test point to the column)	65mm (from test point to the column)
Weight block	1kg	5kg

FRUIT HARDNESS TESTER

- Measure the hardness of apples, pears, strawberries and grapes, etc.
- The degree of ripeness can be judged by measuring the hardness of the fruit

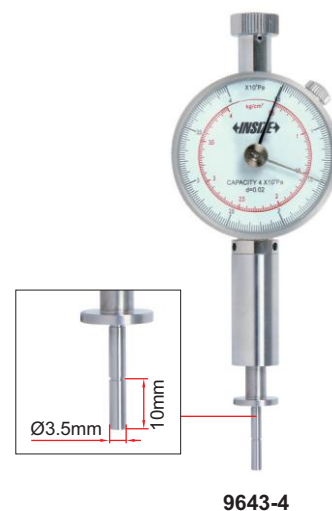

SPECIFICATION

Code	Range	Graduation	Accuracy	Probe diameter	Probe depth	Dimension	Weight
9643-4	0.5-4kg/cm ² (0.5-4×10 ⁵ Pa)	0.02kg/cm ² (0.02×10 ⁵ Pa)	±2%	Ø3.5mm	10mm	151×55×30mm	0.2kg

HARDNESS TEST BLOCKS



Rockwell

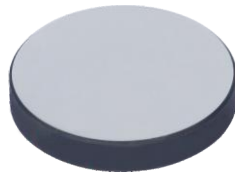

Vickers

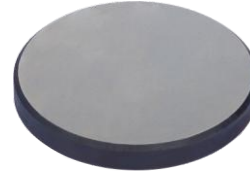

Brinell



Leeb



Micro-Vickers



Knoop



Ultrasonic



Shore

■ Supplied with manufacturer inspection certificate

Rockwell hardness test blocks

Code	Type	Hardness	Dimension *
HDT-B-HRA	HRA	80-84	diameter: (60±1) mm thickness: (11±1) mm
HDT-B-HRB	HRB	88-100	
HDT-B-HRC1	HRC	20-30	
HDT-B-HRC2	HRC	35-55	
HDT-B-HRC3	HRC	60-70	
HDT-B-HRD1	HRD	40-47	
HDT-B-HRD2	HRD	55-63	
HDT-B-HRD3	HRD	70-75	
HDT-B-HRE	HRE	107-114	
HDT-B-HRF	HRF	105-114	
HDT-B-HRG1	HRG	57-82	
HDT-B-HRG2	HRG	80-94	

Vickers hardness test blocks

Code	Type	Hardness	Dimension *
HDT-B-HV5A	HV5	175-200	diameter: (60±1) mm thickness: (11±1) mm
HDT-B-HV5B	HV5	200-300	
HDT-B-HV5C	HV5	300-400	
HDT-B-HV5D	HV5	400-500	
HDT-B-HV5E	HV5	500-600	
HDT-B-HV5F	HV5	600-700	
HDT-B-HV5G	HV5	700-750	
HDT-B-HV10A	HV10	175-200	
HDT-B-HV10B	HV10	200-300	
HDT-B-HV10C	HV10	300-400	
HDT-B-HV10D	HV10	400-500	
HDT-B-HV10E	HV10	500-600	
HDT-B-HV10F	HV10	600-700	
HDT-B-HV10G	HV10	700-750	
HDT-B-HV30A	HV30	175-200	
HDT-B-HV30B	HV30	200-300	
HDT-B-HV30C	HV30	300-400	
HDT-B-HV30D	HV30	400-500	
HDT-B-HV30E	HV30	500-600	
HDT-B-HV30F	HV30	600-700	
HDT-B-HV30G	HV30	700-750	
HDT-B-HV50A	HV50	175-200	
HDT-B-HV50B	HV50	200-300	
HDT-B-HV50C	HV50	300-400	
HDT-B-HV50D	HV50	400-500	
HDT-B-HV50E	HV50	500-600	
HDT-B-HV50F	HV50	600-700	
HDT-B-HV50G	HV50	700-750	
HDT-B-HV100A	HV100	175-200	
HDT-B-HV100B	HV100	200-300	
HDT-B-HV100C	HV100	300-400	
HDT-B-HV100D	HV100	400-500	
HDT-B-HV100E	HV100	500-600	
HDT-B-HV100F	HV100	600-700	
HDT-B-HV100G	HV100	700-750	

Rockwell superficial hardness test blocks

Code	Type	Hardness	Dimension *
HDT-B-HR15N1	HR15N	70-77	diameter: (60±1) mm thickness: (11±1) mm
HDT-B-HR15N2	HR15N	78-88	
HDT-B-HR15N3	HR15N	89-91	
HDT-B-HR30N1	HR30N	42-54	
HDT-B-HR30N2	HR30N	55-73	
HDT-B-HR30N3	HR30N	74-80	
HDT-B-HR45N1	HR45N	20-31	
HDT-B-HR45N2	HR45N	32-61	
HDT-B-HR45N3	HR45N	63-70	
HDT-B-HR15T	HR15T	88-93	
HDT-B-HR30T	HR30T	73-82	
HDT-B-HR45T	HR45T	58-72	

Leeb hardness test blocks

Code	Type	Hardness	Dimension *
HDT-B-HLD1	HLD	490-570	diameter: (90±1) mm thickness: (55±1) mm
HDT-B-HLD2	HLD	590-670	
HDT-B-HLD3	HLD	750-830	
HDT-B-HLG1	HLG	460-540	diameter: (120±1) mm thickness: (70±1) mm
HDT-B-HLG2	HLG	550-630	

To be continued



Continued from previous page

Micro-Vickers hardness test blocks

Code	Type	Hardness	Dimension *
HDT-B-HV005A	HV0.05	200-300	diameter: (25±1) mm thickness: (6±2)mm
HDT-B-HV005B	HV0.05	300-400	
HDT-B-HV005C	HV0.05	400-500	
HDT-B-HV005D	HV0.05	500-600	
HDT-B-HV005E	HV0.05	600-700	
HDT-B-HV005F	HV0.05	700-750	
HDT-B-HV01A	HV0.1	200-300	
HDT-B-HV01B	HV0.1	300-400	
HDT-B-HV01C	HV0.1	400-500	
HDT-B-HV01D	HV0.1	500-600	
HDT-B-HV01E	HV0.1	600-700	
HDT-B-HV01F	HV0.1	700-750	
HDT-B-HV02A	HV0.2	200-300	
HDT-B-HV02B	HV0.2	300-400	
HDT-B-HV02C	HV0.2	400-500	
HDT-B-HV02D	HV0.2	500-600	
HDT-B-HV02E	HV0.2	600-700	
HDT-B-HV02F	HV0.2	700-750	
HDT-B-HV03A	HV0.3	200-300	
HDT-B-HV03B	HV0.3	300-400	
HDT-B-HV03C	HV0.3	400-500	
HDT-B-HV03D	HV0.3	500-600	
HDT-B-HV03E	HV0.3	600-700	
HDT-B-HV03F	HV0.3	700-750	
HDT-B-HV05A	HV0.5	200-300	
HDT-B-HV05B	HV0.5	300-400	
HDT-B-HV05C	HV0.5	400-500	
HDT-B-HV05D	HV0.5	500-600	
HDT-B-HV05E	HV0.5	600-700	
HDT-B-HV05F	HV0.5	700-750	
HDT-B-HV1A	HV1	200-300	
HDT-B-HV1B	HV1	300-400	
HDT-B-HV1C	HV1	400-500	
HDT-B-HV1D	HV1	500-600	
HDT-B-HV1E	HV1	600-700	
HDT-B-HV1F	HV1	700-750	

Knoop hardness test blocks

Code	Type	Hardness	Dimension *
HDT-B-HK005A	HK0.05	200-300	diameter: (25±1) mm thickness: (6±2)mm
HDT-B-HK005B	HK0.05	400-500	
HDT-B-HK005C	HK0.05	700-800	
HDT-B-HK01A	HK0.1	200-300	
HDT-B-HK01B	HK0.1	400-500	
HDT-B-HK01C	HK0.1	700-800	
HDT-B-HK02A	HK0.2	200-300	
HDT-B-HK02B	HK0.2	400-500	
HDT-B-HK02C	HK0.2	700-800	
HDT-B-HK03A	HK0.3	200-300	
HDT-B-HK03B	HK0.3	400-500	
HDT-B-HK03C	HK0.3	700-800	
HDT-B-HK05A	HK0.5	200-300	
HDT-B-HK05B	HK0.5	400-500	
HDT-B-HK05C	HK0.5	700-800	
HDT-B-HK1A	HK1	200-300	
HDT-B-HK1B	HK1	400-500	
HDT-B-HK1C	HK1	700-800	

* The above dimensions are for reference only, subject to actual supply

Brinell hardness test blocks

Code	Type	Hardness	Dimension *	
HDT-B-HB10A1	HBW10/3000	100-200	diameter: (100±1) mm thickness: >16mm	
HDT-B-HB10A2	HBW10/3000	200-300		
HDT-B-HB10A3	HBW10/3000	300-400		
HDT-B-HB10A4	HBW10/3000	400-500		
HDT-B-HB10A5	HBW10/3000	500-600		
HDT-B-HB10A6	HBW10/3000	600-650		
HDT-B-HB10B1	HBW10/1500	100-200		
HDT-B-HB10B2	HBW10/1500	200-300		
HDT-B-HB10B3	HBW10/1500	300-400		
HDT-B-HB10B4	HBW10/1500	400-500		
HDT-B-HB10B5	HBW10/1500	500-600		
HDT-B-HB10B6	HBW10/1500	600-650		
HDT-B-HB10C1	HBW10/1000	90-200		
HDT-B-HB10C2	HBW10/1000	200-300		
HDT-B-HB10C3	HBW10/1000	300-400		
HDT-B-HB10C4	HBW10/1000	400-450		
HDT-B-HB10D1	HBW10/500	90-200		
HDT-B-HB10D2	HBW10/500	200-300		
HDT-B-HB10D3	HBW10/500	300-400		
HDT-B-HB10D4	HBW10/500	400-450		
HDT-B-HB25A1	HBW2.5/187.5	100-200	diameter: (64±1) mm thickness: >6mm	
HDT-B-HB25A2	HBW2.5/187.5	200-300		
HDT-B-HB25A3	HBW2.5/187.5	300-400		
HDT-B-HB25A4	HBW2.5/187.5	400-500		
HDT-B-HB25A5	HBW2.5/187.5	500-600		
HDT-B-HB25A6	HBW2.5/187.5	600-650		
HDT-B-HB25B1	HBW2.5/62.5	90-200		
HDT-B-HB25B2	HBW2.5/62.5	200-300		
HDT-B-HB25B3	HBW2.5/62.5	300-400		
HDT-B-HB25B4	HBW2.5/62.5	400-450		
HDT-B-HB5A1	HBW5/750	100-200		diameter: (100±1) mm thickness: >12mm
HDT-B-HB5A2	HBW5/750	200-300		
HDT-B-HB5A3	HBW5/750	300-400		
HDT-B-HB5A4	HBW5/750	400-500		
HDT-B-HB5A5	HBW5/750	500-600		
HDT-B-HB5A6	HBW5/750	600-650		
HDT-B-HB5B1	HBW5/250	90-200	diameter: (64±1) mm thickness: >6mm	
HDT-B-HB5B2	HBW5/250	200-300		
HDT-B-HB5B3	HBW5/250	300-400		
HDT-B-HB5B4	HBW5/250	400-450		

Shore hardness test blocks

Code	Type	Hardness	Dimension *
HDT-B-SA	SA	6pcs/set (30, 40, 50, 60, 70, 80)	Ø50×7mm
HDT-B-SD	SD	3pcs/set (15, 30, 90)	50×50×7mm

Ultrasonic hardness test blocks

Code	Type	Hardness	Dimension *
HDT-B-HRCU1	HRC	20-30	diameter: (90±1) mm thickness: >16mm
HDT-B-HRCU2	HRC	35-55	
HDT-B-HRCU3	HRC	60-70	
HDT-B-HV5U1	HV5	200-300	
HDT-B-HV5U2	HV5	400-500	
HDT-B-HV5U3	HV5	700-750	
HDT-B-HB10U1	HBW10/1000	90-200	
HDT-B-HB10U2	HBW10/3000	200-300	
HDT-B-HB10U3	HBW10/3000	400-500	

Hammer impact brinell hardness bar

Code	Type	Hardness	Dimension *
HDT-B-HB5C1	HBS5/750	177-217	12×12×150mm

CONCRETE STRENGTH TESTERS



DATA OUTPUT



CST-D101



CST-D102

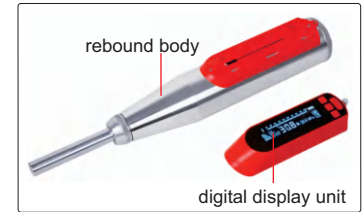

CST-D102 separable

- Measure the strength of general building components, bridges and various concrete components (slabs, beams, columns, bridges, etc.)
- Angle, test surface, pumping, carbonization depth and other parameters can be customized according to the requirements
- The rebound body can be used for 2000 times
- USB data transmission
- The software can automatically generate the test report, and the strength curve can be customized and stored in the tester
- Storage and reading of 1000 test data

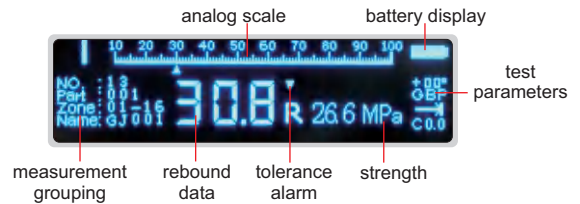

SPECIFICATION

Code	CST-D101	CST-D102
Display	OLED display	
Range	10~60N/mm ²	
Rebound value on anvil	80±2	
Parameter	MPa, N/mm ² , Kgf/mm ²	
Impact energy	2.207J, for testing common buildings or bridge structures	
Output	USB	
Structure	one body, non-seperable	separable, the digital display unit can be reused
Memory	1000 data	
Operation temperature	-40°C~40°C	
Power supply	built-in rechargeable battery	
Dimension	280×75×60mm	
Weight	1.1kg	



software flash disk (included)



abrasive stone (included)



reference anvil (optional)

STANDARD DELIVERY

Main unit	1 pc
Abrasive stone	1 pc
Power adapter	1 pc
Software and USB cable	1 pc

OPTIONAL ACCESSORY

Rebound body (for CST-D102)	CST-D102-REBOUND
Digital display unit (for CST-D102)	CST-D102-DISPLAY
Reference anvil	CST-D-BLOCK

software (included) for uploading and storing data, printing and importing/exporting strength curves

NO	Rebound	M1	M2	M3	M4	M5
1	1	15				
2	2	15.2				
3	3	15.4				
4	4	15.6				
5	5	15.8				
6	6	16				
7	7	16.2				
8	8	16.4				
9	9	16.6				
10	10	16.8				
11	11	17				
12	12	17.2				
13	13	17.4				
14	14	17.6				
15	15	17.8				
16	16	18				
17	17	18.2				
18	18	18.4				
19	19	18.6				
20	20	18.8				
21	21	19				
22	22	19.2				
23	23	19.4				
24	24	19.6				
25	25	19.8				
26	26	19.9	5.7	5.9	13.4	8.7
27	27	20.2	5.8	5.9	13.6	8.4
28	28	20.4	5.8	5.9	13.7	8.5

Concrete compressive strength report detected by rebound method									
Project Name	Project	Learning Unit	Operator	Test Date	2018-12-15	Inspector	Printer	Printer Date	Printer Date
1									
2									
3									
4									
5									
6									
7									
8									
9									
10									
11									
12									
13									
14									
15									
16									



Cutting Machines
Page 879-882



Grinders And Polishers
Page 883-888



Automatic Liquid Droppers
Page 889



Mounting Presses
Page 890-892



Metallurgical Microscopes
Page 892

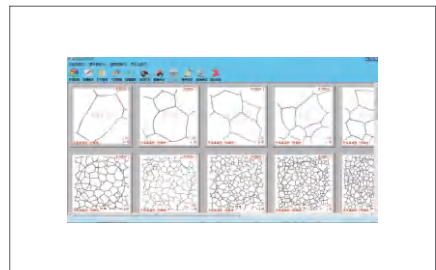

Metallurgical Analysis Softwares
Page 892



Cutting Machine Accessories
Page 893-894



Grinder And Polisher Accessories
Page 896



Mounting Press Accessories
Page 894-896

AUTOMATIC SPECIMEN CUTTING MACHINE (ADVANCED TYPE) CODE MLP-ACM160

TOUCH SCREEN
OPERATION

CUSTOMIZED
CUTTING PROGRAM



diamond blade
(optional)

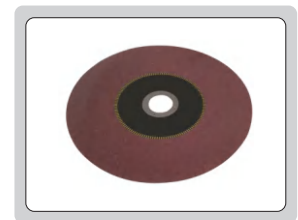

cutting blade
(included)



cutting coolant
(optional)

28

- Touch screen operation, high precision stepper motor control
- Suitable for cutting all kinds of metal and non-metallic materials, in order to observe the metallographic and petrographic organization of materials
- Automated cutting process, low noise, easy to operate, safe and reliable

SPECIFICATION

Maximum cutting diameter	Ø160mm
Cutting speed	0.03~1mm/s
Maximum travel	Z-axis: 0~220mm, Y-axis: 0~200mm, X-axis: 0~240mm
Feed method	continuous feed, pulse feed
Rotation speed range	500~2300r/min
Cutting method	chopping cutting, flat push cutting
Cutting chamber size	1240×780mm
Cutting power	7.5kW
Power supply	AC 380V, 50Hz
Dimension (W×H×D)	1675×1560×1880mm

STANDARD DELIVERY

Main unit	1 pc
Cutting blade	5 pcs, 450×3.2×32mm
Cutting blade chuck	1 set, 2 pcs
Cutting coolant	1 barrel, 6L
Tank assembly	1 set
Clamping station	1 pc

OPTIONAL ACCESSORY

Cutting coolant	MLP-OL4
Cutting blade	MLP-10R series*
Diamond blade	MLP-DQ4

*Optionally available with a cutting blade with an inner diameter of Ø32mm



AUTOMATIC CUTTING MACHINE (ADVANCED TYPE) CODE MLP-HCM102

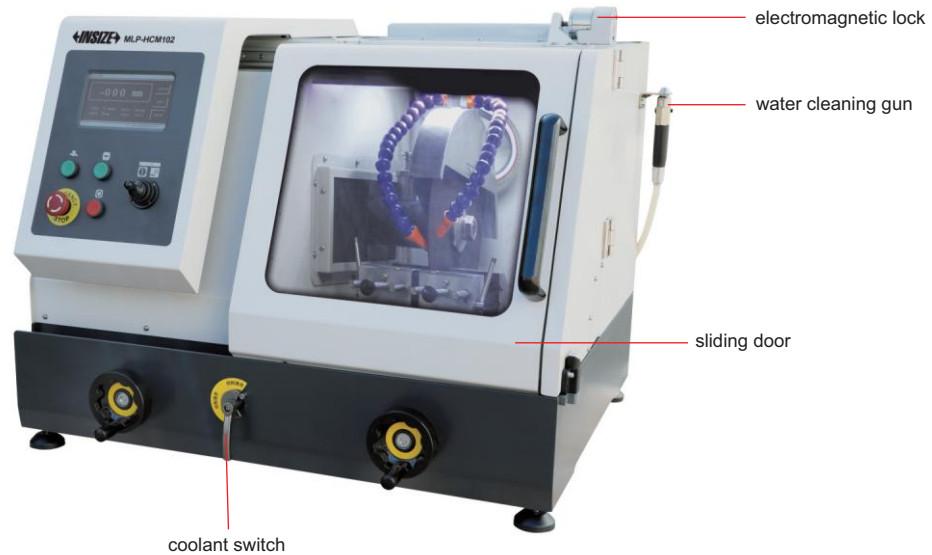

- Suitable for cylinder workpieces (diameters≤100mm) and rectangular samples (height≤70mm, width≤100mm)
- Cooling system avoids overheating and destroying sample structure
- Three cutting modes (manual, pulse, continuous cutting), the cutting feed speed and cutting stroke can be programed

SPECIFICATION

Maximum cutting diameter	Ø100mm
Cutting blade	Ø350×2.5×Ø32mm
Rotation speed	2200r/min
Spindle travel	145mm
Table travel	300mm
Illumination	LED ceiling light
Noise	≤85dB
Cooling tank	60L
Removable baffle	contain
Table dimension	330×280mm
Power	3kW
Power supply	AC 380V, 50Hz
Dimension	900×860×620mm
Weight	285kg

STANDARD DELIVERY

Main unit	1 pc
Cutting blade	5 pcs
Cutting blade chuck	2 pcs
Coolant	1 barrel (4L)
Water tank	1 pc

OPTIONAL ACCESSORY

Coolant (4L, 1:20 diluted with water)	MLP-OL3
Cutting blade (Ø350×2.5×Ø32mm, 40 pcs/box)	MLP-50Z4
	MLP-60Y4 *
Cutting blade chuck (for Ø32mm cutting blade)	MLP-HCM102-CHUCK

* Special cutting blade for high hardness



coolant (included)



cutting blade MLP-50Z4
(included)

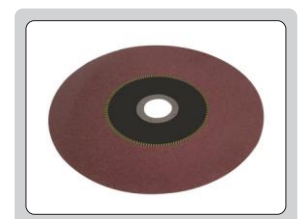

cutting blade MLP-60Y4
(optional)

CUTTING MACHINE (STANDARD TYPE) CODE MLP-CM60



- For metal and non-metal materials
- Cooling device avoids overheating and destroying sample structure
- With safety switch, the machine will automatically stop when the cover is opened



SPECIFICATION

Maximum cutting diameter	Ø60mm
Cutting blade	Ø250×1.5×Ø25.4mm
Rotation speed	2800r/min
Motor power	2.2kW
Power supply	AC 380V, 50Hz
Dimension	830×620×450mm
Weight	82kg



cutting blade **MLP-CM60-CUT2**
(included)

STANDARD DELIVERY

Main unit	1 pc
Cutting blade	2 pcs
Coolant	1 barrel (4L)
Water tank	1 pc

OPTIONAL ACCESSORY

Coolant (4L, 1:20 diluted with water)	MLP-OL3
Cutting blade (Ø250×1.5×Ø25.4mm, 60 pcs/box)	MLP-CM60-CUT2
Cutting blade (Ø250×2×Ø32mm, 50 pcs/box)	MLP-50Z2 *
Cutting blade chuck (for Ø32mm cutting blade)	MLP-CM60-CHUCK



coolant (optional)

* When use **MLP-50Z2**, please purchase **MLP-CM60-CHUCK**



CUTTING MACHINE (BASIC TYPE) CODE MLP-CM86



- For metal and non-metal materials
- Cooling device avoids overheating and destroying sample structure

SPECIFICATION

Maximum cutting diameter	Ø80mm
Cutting blade	Ø250×2×Ø32mm
Rotation speed	2800r/min
Power	3kW
Power supply	AC 380V, 50Hz
Dimension	690×790×670mm

STANDARD DELIVERY

Main unit	1 pc
Cutting blade	2 pcs
Coolant	1 barrel (4L)
Water tank	1 pc

OPTIONAL ACCESSORY

Coolant (4L, 1:20 diluted with water)	MLP-OL3
Cutting blade (Ø250×2×Ø32mm, 50 pcs/box)	MLP-60Y2*
	MLP-50Z2
Cutting blade chuck (for Ø32mm cutting blade)	MLP-CM86-CHUCK

*Special cutting blade for high hardness



coolant (included)



cutting blade MLP-50Z2
(included)



cutting blade MLP-60Y2
(optional)

AUTOMATIC GRINDER AND POLISHER (ADVANCED TYPE) CODE MLP-GP406



**AUTOMATIC DISPENSING
OF ABRASIVES**

**CUSTOMIZED GRINDING
AND POLISHING PROGRAMS**

**TOUCHSCREEN
OPERATION**

- ABS shell and stainless steel parts, anti-corrosion, easy to clean
- Can hold up to 6 samples (4 holes are optional)
- Smooth rotation, low noise
- Adjustable speed
- Intuitive pressure and time setting, 256 sets of grinding and polishing programs can be stored
- Water cooling device and abrasive cleaning nozzle prevent samples from overheating and destroying structure
- Replaceable platen, platen rotation direction can be selected
- Centre loading and single point loading, automatic abrasive distribution



polishing cloth
(included)



anti-stick disc
(included)



magnetic pad
(included)



silicon carbide
paper (included)



dripping system
(optional)

SPECIFICATION

Wheel diameter	Ø250mm (customizable)	
Wheel rotation speed	0~1000r/min (adjustment step 20rpm), 150r/min, 300r/min, 600r/min, 1000r/min (four fixed speeds)	
Wheel rotation direction	clockwise or counterclockwise	
Grinding head speed	50~150r/min (stepless adjustable)	
Pressure range	5~60N (single point loading), 20~200N (centre loading)	
Operation	number	6
	time	0~12h
Sample diameter	Ø30mm (customizable)	
Air pressure	>0.35MPa	
Programmable quantity	256 sets of grinding programs can be stored	
Power supply	AC 220V, 50Hz, 3.1kW	
Dimension (W×H×D)	760×706×717mm	
Weight	126kg	

STANDARD DELIVERY

Main unit	1 pc
Silicon carbide paper	20 pcs each (240, 400, 800, 1200), 80 pcs in total
Polishing cloth	3 pcs each (velvet silk, woolen fabric), 6 pcs in total
Polishing agent	1 pc (W2.5, 500ml)
Spray polish agent	1 pc (W2.5, 500ml)
Anti-stick disc	2 pcs (Ø250mm)
Magnetic pad	5 pcs (Ø250mm)

OPTIONAL ACCESSORY

Silicon carbide paper	MLP-SZ□□*	diameter: Ø250mm 120, 180, 240, 400, 600, 800, 1000, 1200, 1500, 2000, 2500, 3000
Polishing cloth	MLP-CT□□*	Ø250mm
Diamond polishing liquid	MLP-DLA□□*	500ml, select granularity (µm): W40, W28, W20, W14, W9, W7, W5, W3.5, W2.5, W1.5, W1.0, W0.5, W0.25
Diamond spray polish agent	MLP-DSA□□*	350ml, select granularity (µm): W40, W28, W20, W14, W9, W7, W5, W3.5, W2.5, W1.5, W1.0, W0.5, W0.25
Magnetic pad	MLP-AD2	Ø250mm
Anti-stick disc	MLP-DC2	Ø250mm

*□□ is granularity specification, for example, code **MLP-DLA40** stands for 40µm

TOUCHSCREEN
OPERATION

AUTOMATIC DISPENSING
OF ABRASIVES

CUSTOMIZED GRINDING
AND POLISHING PROGRAMS



AUTOMATIC GRINDER AND POLISHER (ADVANCED TYPE) CODE MLP-GP505

- ABS shell and stainless steel parts, anti-corrosion, easy to clean
- Can hold up to 6 samples (4 holes are optional)
- Smooth rotation, low noise
- Adjustable speed
- Intuitive pressure and time setting, 256 sets of grinding and polishing programs can be stored
- Water cooling device and abrasive cleaning nozzle prevent samples from overheating and destroying structure
- Replaceable platen, platen rotation direction can be selected
- Centre loading and single point loading, automatic abrasive distribution



polishing cloth
(included)



anti-stick disc
(included)

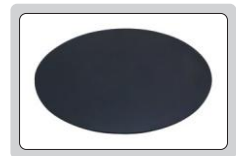

magnetic pad
(included)

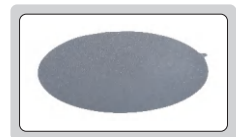

silicon carbide
paper (included)



dripping system
(optional)

SPECIFICATION

Wheel diameter	Ø250mm (customizable)	
Wheel rotation speed	0~1000r/min (adjustment step 20rpm), 150r/min, 300r/min, 600r/min, 1000r/min (four fixed speeds)	
Wheel rotation direction	clockwise or counterclockwise	
Grinding head speed	50~150r/min (stepless adjustable)	
Pressure range	5~60N (single point loading), 20~200N (centre loading)	
Operation	number	6
	time	0~12h
Sample diameter	Ø30mm (customizable)	
Air pressure	>0.35MPa	
Programmable quantity	256 sets of grinding programs can be stored	
Power supply	AC 220V, 50Hz, 2.1kW	
Dimension (W×H×D)	596×714×707mm	
Weight	102kg	

STANDARD DELIVERY

Main unit	1 pc
Silicon carbide paper	20 pcs each (240, 400, 800, 1200), 80 pcs in total
Polishing cloth	3 pcs each (velvet silk, woolen fabric), 6 pcs in total
Polishing agent	1 pc (W2.5, 500ml)
Spray polish agent	1 pc (W2.5, 500ml)
Anti-stick disc	1 pc (Ø250mm)
Magnetic pad	5 pcs (Ø250mm)

OPTIONAL ACCESSORY

Silicon carbide paper	MLP-SZ□□*	diameter: Ø250mm 120, 180, 240, 400, 600, 800, 1000, 1200, 1500, 2000, 2500, 3000
Polishing cloth	MLP-CT□□*	Ø250mm
Diamond polishing liquid	MLP-DLA□□*	500ml, select granularity (µm): W40, W28, W20, W14, W9, W7, W5, W3.5, W2.5, W1.5, W1.0, W0.5, W0.25
Diamond spray polish agent	MLP-DSA□□*	350ml, select granularity (µm): W40, W28, W20, W14, W9, W7, W5, W3.5, W2.5, W1.5, W1.0, W0.5, W0.25
Magnetic pad	MLP-AD2	Ø250mm
Anti-stick disc	MLP-DC2	Ø250mm

*□□ is granularity specification, for example, code MLP-DLA40 stands for 40µm

AUTOMATIC GRINDER AND POLISHER (STANDARD TYPE) CODE MLP-GP305



- Replaceable double wheels, rotation direction can be selected
- Multi sample holder, pneumatic single point loading, automatic abrasive distribution
- Adjustable speed
- Water cooling device and abrasive cleaning nozzle prevent samples from overheating and destroying structure
- ABS case and stainless steel parts, anti-corrosion, easy to clean
- Metallographic samples can be roughly ground, finely ground, roughly polished and finely polished

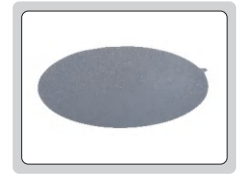

silicon carbide paper
(included)

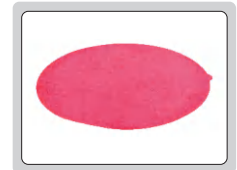

polishing cloth (included)

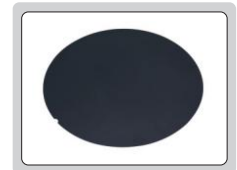

anti-stick disc (included)

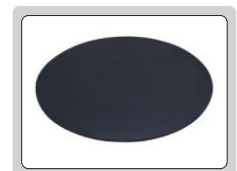

magnetic pad (included)

SPECIFICATION

Wheel diameter	Ø250mm (customizable Ø300mm)
Wheel rotation speed	50~1000r/min (stepless adjustable), 150r/min, 300r/min (two fixed speeds)
Wheel rotation direction	clockwise or counterclockwise
Grinding head speed	50~150r/min (stepless adjustable)
Pressure range	5~60N
Operation number	6
Operation time	0~995s
Sample diameter	Ø30mm (customizable Ø22mm, Ø25mm, Ø30mm, Ø40mm, Ø45mm, Ø50mm)
Air pressure	0.6~0.9MPa
Power supply	AC220V, 50Hz
Input power	1.1kW
Dimension	758×785×680mm
Weight	125kg

STANDARD DELIVERY

Main unit	1 pc
Silicon carbide paper	20 pcs each (240, 250, 400, 800, 1200), 100 pcs in total
Polishing cloth	3 pcs each (velvet silk, woolen fabric), 6 pcs in total
Polishing agent	1 pc (W2.5, 500ml)
Spray polish agent	1 pc (W2.5, 350ml)
Magnetic pad	2 pcs (Ø250mm)
Anti-stick disc	3 pcs (Ø250mm)

OPTIONAL ACCESSORY

Silicon carbide paper	MLP-SZ□□*	diameter: Ø250mm 120, 180, 240, 400, 600, 800, 1000, 1200, 1500, 2000, 2500, 3000
Polishing cloth	MLP-CT□□*	Ø250mm
Diamond polishing liquid	MLP-DLA□□*	500ml, select granularity (µm): W40, W28, W20, W14, W9, W7, W5, W3.5, W2.5, W1.5, W1.0, W0.5, W0.25
Diamond spray polish agent	MLP-DSA□□*	350ml, select granularity (µm): W40, W28, W20, W14, W9, W7, W5, W3.5, W2.5, W1.5, W1.0, W0.5, W0.25
Magnetic pad	MLP-AD2	Ø250mm
Anti-stick disc	MLP-DC2	Ø250mm

*□□ is granularity specification, for example, code MLP-DLA40 stands for 40µm



AUTOMATIC GRINDER AND POLISHER (STANDARD TYPE) CODE MLP-GP260

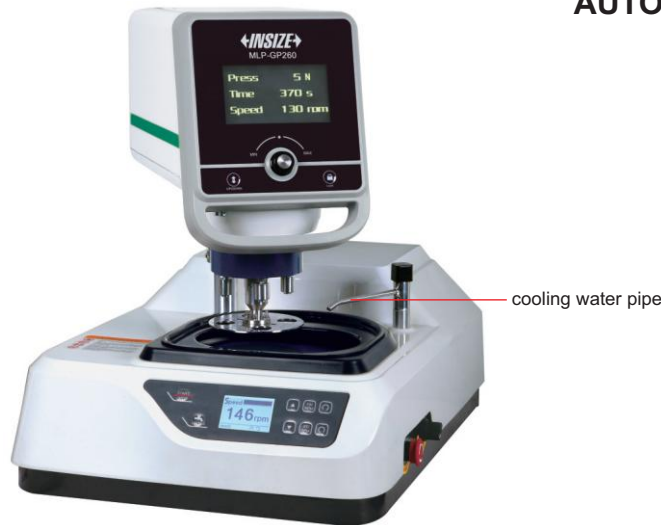

- ABS case and stainless steel parts, anti-corrosion, easy to clean
- Can hold up to 4 samples (6 holes are optional and can hold up to 6 samples)
- Smooth rotation, low noise
- Adjustable speed
- Water cooling device and abrasive cleaning nozzle prevent samples from overheating and destroying structure
- Wheel rotation direction can be selected
- Replaceable wheel

SPECIFICATION

Wheel diameter	Ø250mm
Wheel rotation speed	50~999r/min (stepless adjustable), 150 or 300r/min (two fixed speeds)
Wheel rotation direction	clockwise or counterclockwise
Grinding head speed	50~150r/min (stepless adjustable)
Pressure range	5~60N
Operation time	5~995s
Sample diameter	Ø30mm (can be customized)
Air pressure	0.6~0.9MPa
Power supply	AC 220V, 50Hz
Input power	1.1kW
Dimension	594×795×687mm
Weight	98kg

STANDARD DELIVERY

Main unit	1 pc
Silicon carbide paper	20 pcs each (240, 400, 800, 1200), 80 pcs in total
Polishing cloth	3 pcs each (velvet silk, woolen fabric), 6 pcs in total
Polishing agent	1 pc (W2.5, 500ml)
Spray polish agent	1 pc (W2.5, 500ml)
Anti-stick disc	1 pc (Ø250mm)
Magnetic pad	5 pcs (Ø250mm)

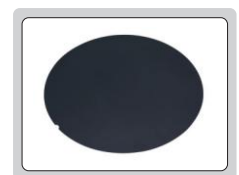

anti-stick disc (included)

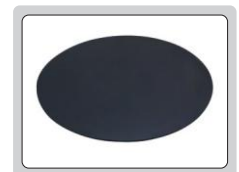

magnetic pad (included)

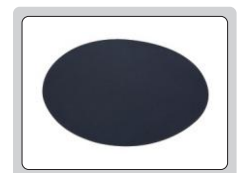

silicon carbide paper (included)

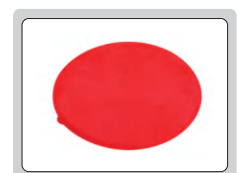

polishing cloth (included)

OPTIONAL ACCESSORY

Silicon carbide paper	MLP-SZ□□*	diameter: Ø250mm 120, 180, 240, 400, 600, 800, 1000, 1200, 1500, 2000, 2500, 3000
Polishing cloth	MLP-CT□□*	Ø250mm
Diamond polishing liquid	MLP-DLA□□*	500ml, select granularity (µm): W40, W28, W20, W14, W9, W7, W5, W3.5, W2.5, W1.5, W1.0, W0.5, W0.25
Diamond spray polish agent	MLP-DSA□□*	350ml, select granularity (µm): W40, W28, W20, W14, W9, W7, W5, W3.5, W2.5, W1.5, W1.0, W0.5, W0.25
Magnetic pad	MLP-AD2	Ø250mm
Anti-stick disc	MLP-DC2	Ø250mm

*□□ is granularity specification, for example, code MLP-DLA40 stands for 40µm

MANUAL GRINDERS AND POLISHERS (STANDARD TYPE)



- ABS case and stainless steel parts, anti-corrosion, easy to clean
- Replaceable double wheel, wheel can be controlled independently, rotation direction can be selected
- Smooth rotation, low noise
- Four fixed speeds/stepless adjustable speed
- Water cooling device, prevent samples from overheating and destroying structure
- Metallographic samples can be roughly ground, finely ground, roughly polished and finely polished



MPL-GP280



silicon carbide paper
(included)

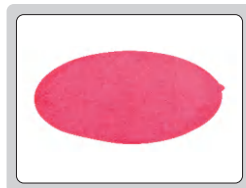

polishing cloth (included)



magnetic pad (optional)

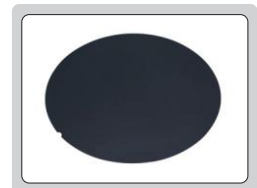

anti-stick disc
(optional)

SPECIFICATION

Code	MPL-GP270	MPL-GP280
Wheel diameter	Ø203mm	Ø250mm
Wheel rotation speed	0-1400r/min (stepless adjustable)	0-1000r/min (stepless adjustable)
Wheel rotation direction	clockwise or counterclockwise	
Fixed speed	150r/min, 300r/min, 600r/min, 1000r/min	
Power supply	AC 220V, 50Hz	
Input power	1.5kW	
Dimension	758×785×310mm	
Weight	50kg	

STANDARD DELIVERY

Main unit	1 pc
Silicon carbide paper	5 pcs each (240, 400, 800, 1200), 20 pcs in total
Polishing cloth	3 pcs
Polishing agent	1 pc

OPTIONAL ACCESSORY

Silicon carbide paper	MPL-SZ□□* (for MPL-GP270)	diameter: Ø200mm 120, 180, 240, 400, 600, 800, 1000, 1200, 1500, 2000, 3000
	MPL-SZ□□* (for MPL-GP280)	diameter: Ø250mm 120, 180, 240, 400, 600, 800, 1000, 1200, 1500, 2000, 3000
Polishing cloth	MPL-CT□□* (for MPL-GP270)	diameter: Ø200mm
	MPL-CT□□* (for MPL-GP280)	diameter: Ø250mm
Diamond polishing liquid	MPL-DLA□□*	500ml, select granularity (µm): W40, W28, W20, W14, W9, W7, W5, W3.5, W2.5, W1.5, W1.0, W0.5, W0.25
Diamond spray polish agent	MPL-DSA□□*	350ml, select granularity (µm): W40, W28, W20, W14, W9, W7, W5, W3.5, W2.5, W1.5, W1.0, W0.5, W0.25
Magnetic pad	MPL-AD1 (for MPL-GP270)	Ø203mm
	MPL-AD2 (for MPL-GP280)	Ø250mm
Anti-stick disc	MPL-DC1 (for MPL-GP270)	Ø203mm
	MPL-DC2 (for MPL-GP280)	Ø250mm

* □□ is granularity specification, for example, code MPL-SZB120 indicates 120 grit Ø200mm sandpaper without adhesive backing



MANUAL GRINDER AND POLISHER (BASIC TYPE) CODE MLP-GP314



- Double wheels, rotation direction can be selected
- Smooth rotation, low noise
- Water cooling device, prevent samples from overheating and destroying structure
- Replaceable silicon carbide paper and polishing cloth for grinding and polishing process



silicon carbide paper
(included)

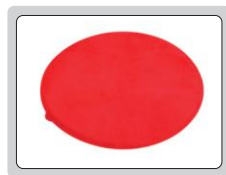

polishing cloth (included)

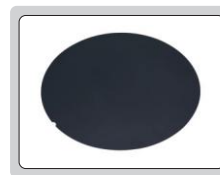

anti-stick disc (optional)



magnetic pad (optional)

SPECIFICATION

Wheel diameter	Ø203mm
Wheel rotation speed	0~1400r/min (stepless adjustable)
Wheel rotation direction	clockwise or counterclockwise
Power supply	AC 220V, 50Hz
Input power	0.75kW
Dimension	755×700×310mm
Weight	50kg

STANDARD DELIVERY

Main unit	1 pc
Silicon carbide paper	5 pcs each (240, 400, 800, 1200), 20 pcs in total
Polishing cloth	4 pcs
Polishing agent	1 pc (W2.5, 500ml)

OPTIONAL ACCESSORY

Silicon carbide paper	MLP-SZ□□*	diameter: Ø200mm 120, 180, 240, 400, 600, 800, 1000, 1200, 1500, 2000, 2500, 3000
Polishing cloth	MLP-CT□□*	Ø200mm
Diamond polishing liquid	MLP-DLA□□*	500ml, select granularity (µm): W40, W28, W20, W14, W9, W7, W5, W3.5, W2.5, W1.5, W1.0, W0.5, W0.25
Diamond spray polish agent	MLP-DSA□□*	350ml, select granularity (µm): W40, W28, W20, W14, W9, W7, W5, W3.5, W2.5, W1.5, W1.0, W0.5, W0.25
Magnetic pad	MLP-AD1	Ø203mm
Anti-stick disc	MLP-DC1	Ø203mm

* □□ is granularity specification, for example, code MLP-SZB120 indicates 120 grit Ø200mm sandpaper without adhesive backing

AUTOMATIC LIQUID DROPPERS



MLP-PLD101



MLP-PLD101S

- Adopting advanced micro-controller, compact structure, reliable operation, strong anti-interference ability
- Suitable for various types of grinding and polishing machines, the polishing liquid is automatically dripped between the abrasive disk and the sample tray to achieve the purpose of polishing
- Reduced polishing time, increased polishing efficiency



polishing fluid (Optional)

28

SPECIFICATION

Code	MLP-PLD101 (single type)	MLP-PLD101S (combination type)
Dropping rate	0.3~10ml/min	
Number of steps	10-speed	
Tank volume	750ml	
Power supply	AC 220V, 50Hz	
Dimension (W×H×D)	144×231×197mm	580×235×212mm
Weight	2.95kg	19.5kg

STANDARD DELIVERY

Main unit	1 pc
Diamond polishing liquid	1 pc (W2.5, 500ml)

OPTIONAL ACCESSORY

Diamond polishing liquid	MLP-DLA ^{□□*} , MLP-DLB ^{□□*} , MLP-DLC ^{□□*} , MLP-DLD ^{□□*} , MLP-DLE ^{□□*} , MLP-DLF ^{□□*}
Aluminum oxide polishing liquid	MLP-LXA ^{□□*} , MLP-LXB ^{□□*}
Silicon dioxide polishing liquid	MLP-GF1, MLP-GF2, MLP-GF3
Polishing lubricant	MLP-RH1, MLP-RH2, MLP-RH3

*□□ is granularity specification, for example, code MLP-DLA40 stands for 40μm



MOUNTING PRESSES (ADVANCED TYPE)



MLP-MP43



MLP-MP53

- Built-in heating and cooling structure reduces the mounting time to 6 minutes
- The programmed control system reserves 10 customized preparation schemes to meet different mounting requirements
- The thickness of the middle mold is up to 15mm, and 2 samples can be mounted at the same time at one station
- Can accurately control the pressure size, adjustment range: 1~20MPa



hot mounting resin (included)

SPECIFICATION

Code	MLP-MP43	MLP-MP53
Station number	1	2
Power	1100W+heating power *	1200W+heating power×2
Mounting diameter	Ø30mm (customizable Ø25, Ø40, Ø50mm)	
System pressure	1~20MPa, optional increase or decrease 1MPa	
Pressure mode	automatic electro-hydraulic	
Cooling mode	automatic water cooling **	
Heating range	90~200°C	
Holding time	0~10min	
Cooling temperature/time	40~90°C/0~10min	
Power supply	AC 220V, 50Hz	
Dimension	530×485×463mm	671×485×463mm
Weight	44kg	77kg

* Heating power of mounting sleeve: 1800W (mounting diameter≤31.8mm), 2400W (mounting diameter≥38.1mm)

** Cooling water pressure should not be higher than 1MPa, must be filtered through 40µm filter

STANDARD DELIVERY

Main unit	1 pc
Hot mounting resin	1 bottle (250g)
Funnel	1 pc
Filter	1 pc
Vacuum cleaner tip	1 pc

OPTIONAL ACCESSORY

Hot mounting resin (black, 4kg)	MLP-DR3
---------------------------------	---------

MOUNTING PRESS (STANDARD TYPE) CODE MLP-MP30



- Automatic heating, pressuring, cooling and pressure relief
- Water cooling system



hot mounting resin (optional)



SPECIFICATION

Diameter of workpiece	Ø30mm
Heating temperature range	100~200°C
Delay range	0~999s
Hold time	0~999s
Cooling temperature	20~90°C
Heating power	600W
Power supply	AC 220V, 50Hz
Dimension	350×450×470mm
Weight	45kg

STANDARD DELIVERY

Main unit	1 pc
Hot mounting resin	1 bottle (250g)
Funnel	1 pc

OPTIONAL ACCESSORY

Hot mounting resin (black, 4kg)	MLP-DR3
---------------------------------	---------

MOUNTING PRESS (BASIC TYPE) CODE MLP-MP62



- Suitable for tiny, difficult to handle or irregular metallographic and petrographic samples
- The sample preparation program has three modes: bakelite powder, electric jade powder and user-defined
- The sample preparation program controls the sample preparation time and realizes unattended sample preparation



hot mounting resin (included)



SPECIFICATION

Mounting diameter	Ø30mm (customizable Ø22mm, Ø45mm)
Heating range	room temperature~200°C
Timing range	0~30min
Power	≤800W
Power supply	AC220V, 50Hz
Dimension	440×253×310mm
Weight	32kg

STANDARD DELIVERY

Main unit	1 pc
Hot mounting resin	1 bottle (60g)
Funnel	1 pc

OPTIONAL ACCESSORY

Hot mounting resin (black, 4kg)	MLP-DR3
---------------------------------	---------



- Suitable for epoxy resins and cold mosaic compound of polyester castable
- High efficiency, simple and reliable



cold mounting compound (optional)

VACUUM MOUNTING PRESS
CODE MLP-MP25



SPECIFICATION

Maximum vacuum	-58kPa
Vacuum chamber size	Ø260×125mm
Transposition speed	5r/min
Input power	6W
Power supply	220/110V
Dimension	460×400×403mm
Weight	30kg

STANDARD DELIVERY

Main unit	1 pc
Vacuum pump	1 pc
Ø25mm mold	1 pc
Ø30mm mold	1 pc
Ø40mm mold	1 pc
Ø50mm mold	1 pc
Epoxy resin (400g)	1 pc
Curing agent (200g)	1 pc
Waxed paper tray	10 pcs

OPTIONAL ACCESSORY

Cold mounting compound	MLP-CM1, MLP-CM6
Epoxy resin	MLP-CM3, MLP-CM4

REFER TO PAGE
736-740 FOR DETAILS



5102-M600



5108-M3000



5103-M1000

METALLURGICAL MICROSCOPES

METALLURGICAL ANALYSIS SOFTWARE AND CAMERA

REFER TO PAGE
761-762 FOR DETAILS

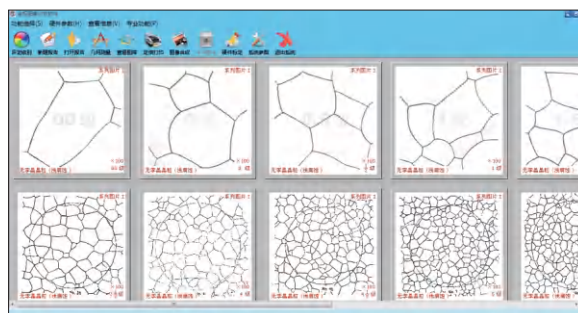

ISM-MAS100

DIAMOND BLADES

- Specially for precision cutting of carbide, ceramic materials, optical glass and other brittle metal materials



Code	Description	Specification (mm)
MLP-DQ1	1. saw blade is made of edge electroplating 2. used for small workpieces made of crystal, ceramic, glass and alloy materials	Ø100×0.4×12.7
MLP-DQ2		Ø150×0.5×12.7
MLP-DQ3	1. saw blade is made of edge sintering technology 2. used for hard alloy, ceramic, optical glass and other brittle metal materials	Ø100×0.5×20
MLP-DQ4		Ø200×1×32

CUTTING BLADES



MLP-50Z1

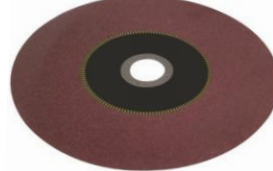

MLP-60Y1

Code	Application	Cutting blade size	Package (pcs/box)
MLP-10R1	1. light non-ferrous metal 2. high toughness metal (Ti) 3. HV hardness value: 0~250	Ø250×1.5×32mm	60
MLP-10R2		Ø250×2×32mm	50
MLP-10R3		Ø300×2×32mm	50
MLP-10R4		Ø350×2.5×32mm	40
MLP-20R1	1. soft ferrous metal 2. HV hardness value: 50~300	Ø250×1.5×32mm	60
MLP-20R2		Ø250×2×32mm	50
MLP-20R3		Ø300×2×32mm	50
MLP-20R4		Ø350×2.5×32mm	40
MLP-30R1	1. medium soft ferrous metal 2. HV hardness value: 120~500	Ø250×1.5×32mm	60
MLP-30R2		Ø250×2×32mm	50
MLP-30R3		Ø300×2×32mm	50
MLP-30R4		Ø350×2.5×32mm	40
MLP-40Z1	1. medium hardness ferrous metal 2. HV hardness value: 180~600	Ø250×1.5×32mm	60
MLP-40Z2		Ø250×2×32mm	50
MLP-40Z3		Ø300×2×32mm	50
MLP-40Z4		Ø350×2.5×32mm	40
MLP-50Z1	1. hard ferrous metal 2. HV hardness value: 180~700	Ø250×1.5×32mm	60
MLP-50Z2		Ø250×2×32mm	50
MLP-50Z3		Ø300×2×32mm	50
MLP-50Z4		Ø350×2.5×32mm	40
MLP-50Z5		Ø400×3×32mm	25
MLP-50Z6		Ø450×3.2×32mm	25
MLP-50Z7		Ø509×4×38.1mm	10
MLP-50Z8		Ø610×4×38.1mm	10
MLP-60Y1	1. high hardness ferrous metal 2. HV hardness value: 250~900	Ø250×1.5×32mm	60
MLP-60Y2		Ø250×2×32mm	50
MLP-60Y3		Ø300×2×32mm	50
MLP-60Y4		Ø350×2.5×32mm	40

- Cutting surfaces are bright and smooth without burning

CUTTING COOLANT

- Free of mineral oil and sodium nitrite, suitable for all kinds of metallographic cutting machines
- Harmless to human health and environment

Code	Description	Specification
MLP-OL1	1. fully synthetic concentrate, used for various types of cutting machines, specially for built-in cooling circulatory system models 2. concentrate, dilute 1:20 with water 3. replace regularly, recommended once a month	1L
MLP-OL2		2L
MLP-OL3		4L
MLP-OL4		6L
MLP-OL5		10L
MLP-OL6	1. oily mixture, use directly 2. cut water sensitive materials at low speed (high speed cutting machine is prohibited) 3. replace regularly, recommended once a month	1L
MLP-OL7		4L



HOT MOUNTING RESIN

- Suitable for small sample preparation



Code	Color	Description	Package (barrel)
MLP-DR1	black	for common sample preparation, fast grinding speed	0.5kg
MLP-DR2			1kg
MLP-DR3			4kg
MLP-DR4	black	edge protection type, low shrinkage, sample binding, high hardness, good wear resistance, slow grinding speed	0.5kg
MLP-DR5			1kg
MLP-DR6			4kg
MLP-DR7	black	carbon phenolic polymer, used in highly conductive fields, medium grinding speed	0.5kg
MLP-DR8			1kg
MLP-DR9	red	for common sample preparation, fast grinding speed	0.5kg
MLP-DR10			1kg
MLP-DR11	white	for common sample preparation, fast grinding speed	0.5kg
MLP-DR12			1kg
MLP-DR13			4kg
MLP-DR14	green	for common sample preparation, fast grinding speed	0.5kg
MLP-DR15			1kg
MLP-DR16			4kg
MLP-DR17	transparent	transparent, soluble, for sample with size, position, depth and other requirements	0.5kg
MLP-DR18			1kg
MLP-DR19			4kg

COLD MOUNTING CONSUMABLES



cold mounting resin



curing agent

Code	Description	Package
MLP-CM1	<ol style="list-style-type: none"> 1. cold mounting compound, fast speed/good transparency/low viscosity/high strength 2. for metal processing without heating, pressure and mounting press 3. curing time: 25°C, 25min 4. usage: cold mounting resin 3:curing agent 2 	<ol style="list-style-type: none"> 1. cold mounting resin 1000g 2. curing agent 800ml 3. Ø30mm cold mounting mold 1pc 4. plastic cup 20pcs 5. stirring rod 40pcs, spoon 1pc
MLP-CM2	<ol style="list-style-type: none"> 1. epoxy resin, low viscosity, good permeability, completely transparent 2. for samples which can not be heated or mounting pressed, like PCB, SMT and other micro-slice samples 3. curing time: 25°C, 5-6h 4. usage: resin liquid 2:curing agent 1 	<ol style="list-style-type: none"> 1. resin liquid 1000ml 2. curing agent 500ml 3. Ø30mm cold mounting mold 1pc 4. plastic cup 20pcs 5. stirring rod 40pcs
MLP-CM3	<ol style="list-style-type: none"> 1. fast epoxy, fast curing products, completely transparent 2. for samples which can not be heated or mounting pressed, like PCB, SMT and other micro-slice samples 3. curing time: 25°C, 1h 4. usage: resin liquid 2:curing agent 1 	<ol style="list-style-type: none"> 1. resin liquid 1000ml 2. curing agent 500ml 3. Ø30mm cold mounting mold 1pc 4. plastic cup 20pcs 5. stirring rod 40pcs
MLP-CM4	<ol style="list-style-type: none"> 1. low viscosity epoxy, good permeability, completely transparent 2. for samples which can not be heated or mounting pressed, like PCB, SMT and other micro-slice samples 3. curing time: 25°C, 3-4h 4. usage: resin liquid 2:curing agent 1 	<ol style="list-style-type: none"> 1. resin liquid 1000ml 2. curing agent 500ml 3. Ø30mm cold mounting mold 1pc 4. plastic cup 20pcs 5. stirring rod 40pcs
MLP-CM5	<ol style="list-style-type: none"> 1. low heat release epoxy, small, shrink, completely transparent 2. for samples which can not be heated or mounting pressed, like PCB, SMT and other micro-slice samples 3. curing time: 25°C, 20-24h 4. usage: resin liquid 3:curing agent 1 	<ol style="list-style-type: none"> 1. resin liquid 1000ml, 2. curing agent 300ml 3. Ø30mm cold mounting mold 1pc 4. plastic cup 20pcs 5. stirring rod 40pcs
MLP-CM6	<ol style="list-style-type: none"> 1. cold mounting compound, fast speed/ceramics white/low viscosity/high strength 2. for metal processing without heating, pressure and mounting press 3. curing time: 25°C, 25min 4. usage: cold mounting resin 3:curing agent 2 	<ol style="list-style-type: none"> 1. cold mounting resin 1000g 2. curing agent 800ml 3. Ø30mm cold mounting mold 1pc 4. plastic cup 20pcs 5. stirring rod 40pcs, spoon 1pc

28

COLD MOUNTING MOLDS

Code	Description	Specification (mm)
MLP-QM1	round soft mold, for cold embedding of epoxy resin, cold mounting resin on metallographic slice specimens	Ø20×18
MLP-QM2		Ø25×18
MLP-QM3		Ø30×18
MLP-QM4		Ø40×23
MLP-QM5		Ø50×23
MLP-QM6	square soft mold, for cold embedding of epoxy resin, cold mounting resin on metallographic slice specimens	55×20×22
MLP-QM7		70×40×22
MLP-QM8	round hard mold, for cold embedding of epoxy resin, cold mounting resin on metallographic slice specimens	Ø25×23
MLP-QM9		Ø30×27
MLP-QM10		Ø32×27
MLP-QM11		Ø40×29



MOUNTING DISCHARGING AGENT



Code	Description	Specifications
MLP-RA	for hot mounting press and cold mounting mold discharging	200ml/bottle

SLICE CLIPS



MLP-QP1



MLP-QP2

Code	Description	Specifications
MLP-QP1	stainless steel roll slice clip, for hot and cold mounting fixing	100 pieces/pack
MLP-QP2	PET roll slice clip, for hot and cold mounting fixing	100 pieces/pack

DIAMOND POLISHING LIQUID

- For surface grinding and polishing of metallographic, lithographic, ferrous and non-ferrous metals, ceramics, composite materials, gems, instruments, optical glass of high finish
- Compared with ordinary polishing agent, under the same grinding and polishing quality, consumption is saved 30%, time is saved 60%



Code	Description	Granularity (μm)	Package/Bottle
MLP-DLA $\square\square$ *	1. single crystal, water-based, ethylene glycol-based polishing lubricant formulation 2. for general metallographic preparation	40, 30, 28, 20, 14, 10, 9, 7, 6, 5, 3.5, 3, 2.5, 1.5, 1.0, 0.5, 0.25	500ml
MLP-DLB $\square\square$ *	1. single crystal, water-based, propylene glycol-based polishing lubricant formulation 2. for grinding and polishing of soft and ductile materials	30, 20, 15, 14, 9, 7, 6, 5, 3, 2.5, 1.5, 1.0, 0.5, 0.25	500ml
MLP-DLC $\square\square$ *	1. single crystal, water-based, propylene glycol-based polishing lubricant formulation 2. for ultra-precision polishing	0.05	500ml
MLP-DLD $\square\square$ *	1. single crystal, oil-based, solvent-based polishing lubricant formulation 2. for grinding and polishing of soft materials and materials which cannot touch water	20, 14, 9, 7, 5, 3.5, 2.5, 1.5, 1.0, 0.5, 0.25	500ml
MLP-DLE $\square\square$ *	1. polycrystalline, water-based, propylene glycol based polishing lubricant formula 2. for grinding and polishing of different materials and hardness components	9, 6, 3, 1.0, 0.5, 0.25	500ml
MLP-DLF $\square\square$ *	1. polycrystalline, water-based, denatured ethanol based polishing lubricant formula 2. for grinding and polishing of materials which cannot touch water	9, 6, 3, 1.0, 0.5, 0.25	500ml

* $\square\square$ is granularity specification, for example, code **MLP-DLA40** stands for diamond polishing liquid 40 μm granularity



Portable Eddy Current Flaw Detectors
Page 898-900



Ultrasonic Flaw Detectors
Page 901-902



Standard Test Blocks For Ultrasonic Flaw Detection
Page 903



Portable Magnetic Powder Flaw Detectors
Page 904-905



Fluorescent Magnetic Powder Flaw Detectors
Page 906



Magnetic Powder Test Blocks
Page 907



UV Flaw Detection Lights
Page 908-909



Penetration Standard Test Blocks
Page 910



Supplementary Materials
Page 910-911



Industrial Viewing Lamps
Page 911



Black And White Densitometers
Page 912



Wire Rope Flaw Detectors
Page 912-913



PORTABLE EDDY CURRENT FLAW DETECTOR CODE ECT-S610

- Real-time impedance plane and time base sweep display modes available
- Easy to operate menu interface, with universal knob operation is more convenient and fast
- Analyzes the signal waveform of the entire detection process, automatically measuring phase and amplitude
- With amplitude and phase alarms and settable boundaries
- 5.7" industrial-grade TFT display, can work in outdoor and direct sunlight environment
- 500 sets of data, 500 sets of parameters, or 40 minutes of video storage
- Applicable to all kinds of metal materials and parts, such as weld cracks, copper pipe, seamless steel pipe, stainless steel pipe, folding, scars, pits, cracks, delamination and other defects, with high sensitivity



SPECIFICATION

Detection channel	channel 1 (X1-Y1), channel 2 (X2-Y2), mixing channel
Detection frequency	2
Transmission frequency	50Hz~10MHz
Driving voltage	8 adjustable steps
Phase adjustment	360° (1° step)
Gain adjustment	0~90dB (step 0.1dB)
Sampling frequency	40MHz, 12-bit data acquisition
Digital filtering	high pass: 1Hz-1950Hz, low pass: 3Hz-2000Hz
Alarm mode	amplitude and phase alarm
Alarm box	alarm frame modes: off, amplitude phase, half-amplitude phase, square box
Probe Type	bridge
Display	time base, impedance plane
Auxiliary measurements	automatic/manual measurement of amplitude and phase
Balance mode	digital balance
Display modes	dot, line, fade mode
Interface	Q9 interface, USB HOST, Mini HDMI
Environmental temperature	-10~50°C
Relative humidity	20~95%RH
Power supply	rechargeable lithium battery, working time 6~8h
Dimensions (L×W×H)	251×171×52mm
Weight	1.5kg



right angle probe
(included)



pen probe
(included)



aluminum alloy flat
test block (included)



stainless steel plate
test block (included)

STANDARD DELIVERY

Main unit	1 pc
Pen probe 50K~500KHz	1 pc
Pen probe 500K~3MHz	1 pc
Right angle probe 50K~500KHz	1 pc
Right angle probe 500K~3MHz	1 pc
Aluminum alloy flat test block	1 pc
Stainless steel plate test block	1 pc
Hexagon bar wrench	1 pc
Probe connecting cable	1 pc
Mainframe backpack	1 pc
USB disk	1 pc
Power adapter	1 pc

DIGITAL ULTRASONIC FLAW DETECTOR (ADVANCED TYPE) CODE UFD-P710



external wireless phased array module (optional)



- With fast, accurate display and analysis of defective echo signals, a variety of weak signal changes and details can respond in a timely manner, the real-time echo signal and authenticity can be effectively guaranteed
- For the detection of high attenuation materials or thick workpiece has excellent penetration and letter ratio; sharp wave excitation technology and adjustable pulse width, pulse voltage, emission anisotropic square wave technology in the detection of thin workpiece and composite materials have a high resolution
- FIR digital filtering technology better signal-to-noise ratio; probe frequency harmonic analysis, can better analyze the probe performance information
- Automatic calibration of material speed of sound, probe delay, probe K value; convenient DAC, AVG curve creation and application
- USB HOST interface, can be connected to an external U disk to achieve data transmission; can be connected to an external WIFI module to achieve communication with other wireless devices
- HDMI video output for flaw detection and teaching presentations
- Ultra-large capacity storage space for continuous dynamic recording data storage
- Wireless phased array module can be connected, so that the conventional ultrasonic flaw detector has the same detection function as phased array instrument



single-element straight probe (included)



single-element angle probe (included)



wireless phased array module (optional)



phased array probe (optional)

FUNCTIONS

Flaw detection standard	built-in common flaw detection standards, direct call, convenient and fast
Auto calibration	automatic calibration of probe zero offset, probe angle (K value) and material velocity
Peak hold	compare frozen peak waveforms to live A-Scans to easily interpret test results
Flaw locating	live display sound-path, projection (surface distance), depth, amplitude
Flaw discrimination	automatic flaw sizing using AVG or DAC, speeds reporting of defect acceptance or rejection
Flaw sizing	the equivalent dB value of defects or equivalent size of defects are displayed in real time
Curved surface correction	used for flaw detection of curved workpiece, it can display the circumferential position of defects in real time
DAC/AVG	the curve is automatically generated, and the sampling points can be compensated and corrected. The curve automatically floats with the gain, automatically expands with the detection distance, and automatically moves with the delay time. It can display the AVG curve of any aperture
AWS D1.1/1.5	choosing this standard can reduce manual calculations and improve detection efficiency
Automatic rating	select different AWS standards, automatically calculate the rating of defects and display
Crack height	the crack height is measured and calculated automatically by the diffracted wave at the end
Gate magnify	spreading of the gate range over the entire screen width
Continuous record	video recording and playback
Echo coding	display 1~9 echo display area in different colors, used to analyze the defect position
Scan freeze	display freeze holds waveform and test distance data
Peak mark	capture and mark the peak in real time
B scan	intuitively display the defect shape of the workpiece and the detection result is more intuitive

To be continued

Continued from previous page

SPECIFICATION

Measuring range	0~10000mm
Working frequency	0.5~20MHz
Material velocity	1000~15000m/s, adjustable in continuity; 30 pre-set nominated velocities for common materials
Repetition frequency	25~1600Hz
Dynamic range	≥32dB
Gain range	0.0~110dB (steps: 0.1dB, 1.0dB, 2.0dB, 6.0dB)
Vertical linearity	≤3.0%
Horizontal linearity	≤0.4%
Resolving power	>26dB (2.5P20)
Sensitivity leavings	>62dB (200Ø2 flat bottom hole, narrow band)
Attenuator	12dB±1dB
Suppression	0~99%
Noise	≤10%
Display screen	5.7" TFT color LCD, resolution 640x480
Pulse type	sharp wave, negative square wave, bipolar square wave; transmit voltage 50~250V adjustable, step 50V
Pulse shift	-7.5~3000us
Probe zeroing	0~200us
Rectification	positive, negative, full-play, RF
Gates and alarms	two-way gate, optional: into the wave alarm, lost wave alarm, DAV curve alarm, alarm signal for sound and light alarms measurement mode: peak, frontal
Interface	Q9 (BNC), USB HOST, Mini HDMI
Damping	400Ω, 80Ω
Power supply	rechargeable lithium-ion battery, working time 6~8h
Storage temperature	-30~50°C
Relative humidity	20~95%RH
Size	246×166×50mm
Weight	1.3kg

STANDARD DELIVERY

Main unit	1 pc
Single-element straight probe UFD-P70	1 pc
Single-element angle probe UFD-P71	1 pc
Probe connecting cable	2 pcs
Mainframe backpack	1 pc
USB disk	1 pc
Power adapter	1 pc

OPTIONAL ACCESSORY

Probe	refer to specification of transducers
Wireless phased array module	UFD-PA11
Phased array probe	UFD-PA06

SPECIFICATION OF PROBES

Code	Frequency	Size	Probe type	Probe transducer angle
UFD-P70 (included)	2.5MHz	Ø20mm	single-element straight probe	90°
UFD-P71 (included)	2.5MHz	13×13mm	single-element angle probe	45°
UFD-P72 (optional)	2.5MHz	Ø14mm	dual-element straight probe	90°
UFD-P73 (optional)	5.0MHz	Ø20mm	single-element straight probe	90°
UFD-P74 (optional)	2.5MHz	13×13mm	single-element angle probe	63.4°
UFD-P75 (optional)	5.0MHz	8×12mm	single-element angle probe	68.2°

Note: Other probes can be customized according to customer requirements

SPECIFICATION OF PHASED ARRAY PROBE (OPTIONAL)

Code	Frequency	E-Nos	Pitch (mm)	Elev (mm)	Ptd. angle	Ptd. material
UFD-PA06 (optional)	2.5MHz	16	1.0	10	55°	plexiglass

DIGITAL ULTRASONIC FLAW DETECTOR (ECONOMIC TYPE) CODE UFD-T680



- The all-aluminum metal shell is strong and durable, and the electromagnetic shielding performance is very good
- Tempered glass panel, extremely hard, wear-resistant and scratch-resistant
- Full-digital multi-color high resolution (640×480 pixels) TFT LCD display
- 4 operation interface styles can be selected according to the environment
- Real-time screenshots of all pages and flaw detection reports, and save them as BMP pictures to U disk
- Export the flaw detection report as a PDF file
- Unique Fn multifunction key design
- There is no limit of the number and duration of video recording through U disk
- Memory of 500 channel files to store calibration setups and probe parameter
- Memory of 1000 wave report files to store A-Scan wave and settings
- Two fully independent gates offer a range of measurement options for signal height or distance using peak triggering
- Can choose to set the incoming wave alarm or lost wave alarm, accompanied by LED light display
- Selectable frequency ranges (automatically set by the instrument) to match probe for optimum performance
- The unique automatic gain adjustment and gain scanning function make flaw detection fast and accurate



straight-beam probe
(included)



angle-beam probe
(included)



USB disk
(included)



couplant (included)

29

FUNCTIONS

Flaw detection standard	built-in common flaw detection standards, direct call, convenient and fast
Auto calibration	automatic calibration of probe zero offset, probe angle (K value) and material velocity
Peak hold	compare frozen peak waveforms to live A-Scans to easily interpret test result
Flaw locating	live display sound-path, projection (surface distance), depth, amplitude
Flaw discrimination	automatic flaw sizing using AVG or DAC, speeds reporting of defect acceptance or rejection
Flaw sizing	the equivalent dB value of defects or equivalent size of defects are displayed in real time
Curved surface correction	used for flaw detection of curved workpiece, it can display the circumferential position of defects in real time
DAC/AVG	the curve is automatically generated, and the sampling points can be compensated and corrected. The curve automatically floats with the gain, automatically expands with the detection distance, and automatically moves with the delay time. It can display the AVG curve of any aperture
AWS D1.1	choosing this standard can reduce manual calculations and improve detection efficiency
Weld diagram	support V type, T type, L type and other weld types, acoustic path navigation real-time display, weld and defect location real-time display, scaling, easy to locate defects
Automatic rating	select different AWS standards, automatically calculate the rating of defects and display
Crack height	the crack height is measured and calculated automatically by the diffracted wave at the end
Gate magnify	spreading of the gate range over the entire screen width
Continuous record	video recording and playback
Echo coding	display 1~9 echo display area in different colors, used to analyze the defect position
Scan freeze	display freeze holds waveform and test distance data
Peak mark	capture and mark the peak in real time
B scan	intuitively display the defect shape of the workpiece and the detection result is more intuitive

To be continued

Continued from previous page

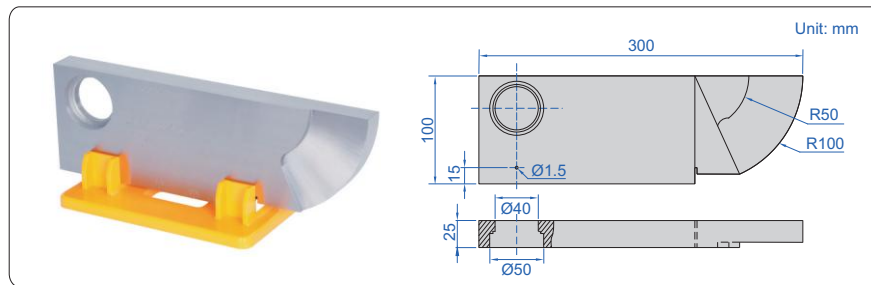

calibration block (optional)

SPECIFICATION

Measuring range	0~15000mm
Working frequency	0.2~20MHz
Material velocity	100~20000m/s
Repetition frequency	20~2000Hz
Dynamic range	≥36dB
Vertical linearity	≤1.5%
Horizontal linearity	≤0.1%
Resolving power	>42dB
Sensitivity leavings	>65dB
Suppression	0~80%
Noise	≤10%
Probe selection	single crystal probe, dual crystal probe, penetrating probe, climbing probe
Pulse energy	100V, 200V, 250V, 300V, 350V, 400V, 450V, 500V (selectable)
Pulse width	30ns-510ns
Probe damping	50Ω, 150Ω, 250Ω, 500Ω (selectable)
Rectification	positive half wave, negative half wave, full wave, RF
Gates	two independent gates controllable over entire sweep range
Interface	USB 2.0
Operation temperature	-10~50°C
Relative humidity	20~95%RH
Power supply	build-in rechargeable battery
Size	263×170×61mm
Weight	1.92kg

STANDARD DELIVERY

Main unit	1 pc
Single-element straight probe UFD-T60	1 pc
Single-element angle probe UFD-T61	1 pc
USB cable	1 pc
Couplant	1 bottle
Probe connecting cable	1 pc
USB disk	1 pc
Power adapter	1 pc

OPTIONAL ACCESSORY

Calibration block	UFD-CSK1
-------------------	----------

SPECIFICATION OF PROBE

Code	Frequency	Size	Probe type	Transducer sensor angle
UFD-T60 (included)	2.5MHz	Ø20mm	single-element straight probe	90°
UFD-T61 (included)	4.0MHz	8×9mm	single-element angle probe	60°
UFD-T62 (optional)	5.0MHz	Ø10mm	dual-element straight probe	90°
UFD-T63 (optional)	5.0MHz	Ø10mm	single-element straight probe	90°
UFD-T64 (optional)	4.0MHz	8×9mm	single-element angle probe	45°
UFD-T65 (optional)	4.0MHz	8×9mm	single-element angle probe	70°

Note: Other types of the probes are available

STANDARD TEST BLOCK FOR ULTRASONIC FLAW DETECTION

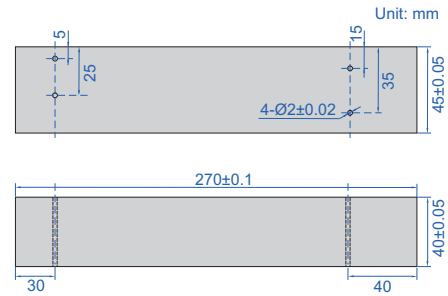

- Conforms to standard NB/T47013
- The test block is designed according to ultrasonic testing requirements on pressure-bearing welded joints (Type I)
- Applicable to tests on welded joints (Type I) by oblique probe and straight probe with work piece thickness range from 6mm to 40mm

SPECIFICATION

(mm)

Code	Material	Measuring range	Transverse hole depth (transverse wave detection)	Transverse hole depth (longitudinal wave detection)
UFD-CSK-2A	20#	≥6~40	5、10、15、25、35	5、10、15、20、30、40

29

STANDARD TEST BLOCK FOR ULTRASONIC FLAW DETECTION

- The test block is used to determine sensitivity margins of straight probe and instrument's comprehensive performances, to adjust sensitivity of flaw detection, to determine sizes of defects and to determine performances indicators and their shapes, e. g. vertical linearity of instrument

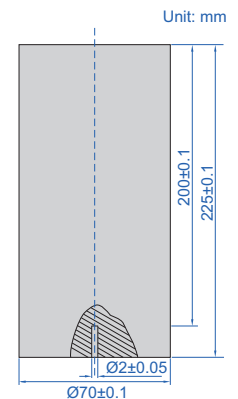

SPECIFICATION

(mm)

Code	Material	Diameter	Length	Aperture (hole depth)
UFD-CS1-5	45#	Ø70	225	Ø2 (25)



PORTABLE MAGNETIC POWDER FLAW DETECTORS



MPI-P110

- Conformity to standards JB/T7411-2012 ASTM E1444-05 ASTM E709 EN10228-1:1999 ISO 9934 ASTM E3024
- Multiple power supply modes available



DC battery pack 4400mAh
(optional)



AC battery pack 6600mAh
(optional)

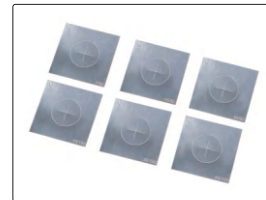

A1 standard sensitivity test piece
(optional)



45N lifting force test block
(optional)



177N lifting force test block
(optional)



magnetic pole slope angle A
(optional)



magnetic pole slope angle B
(optional)



bag (optional)

SPECIFICATION

Code	MPI-P110	MPI-P220	MPI-P330
Magnetic field strength	>2KA/m		
Sensitivity	15/50 engraved groove clearly displayed on A1 standard sensitivity test piece		
Illumination	—	white light ≥ 2320 Lux	UV lamp $\geq 5220\mu\text{W}/\text{cm}^2$
Duty cycle	>50% maximum excitation time 90 seconds		>30%
Lifting power	AC	$\geq 4.5\text{kg}$ (44N)	
	DC	$\geq 18.1\text{kg}$ (177N)	
Magnetic pole spacing	0-230mm		
Magnetic pole size	22×22mm		
Power supply	AC220V, 50/60Hz (DC battery pack or AC battery pack are optional)		
Power cord	european power cord		
Operation temperature	-10~40°C		
Relative humidity	<80% (no condensation)		
Dimension (L×W×H)	235×50×195mm		
Weight	2.3kg		

STANDARD DELIVERY

Main unit	1 pc
-----------	------

OPTIONAL ACCESSORY

DC battery pack 4400mAh	MPI-PDC440
AC battery pack 6600mAh	MPI-PAC660
A1 standard sensitivity test piece	MPI-PA1
45N lifting force test block	MPI-P45N
177N lifting force test block	MPI-P177N
Magnetic pole slope angle A	MPI-PMA
Magnetic pole slope angle B	MPI-PMB
Bag	MPI-PBG
British power cord	MPI-POWER-K
Brazilian power cord	MPI-POWER-B

PORTABLE AC MAGNETIC POWDER FLOW DETECTOR (ADVANCED TYPE)



IP54
WATERPROOF

- Conformity to standards JB/T7411-2012 ASTM E709-08 ASTM E1444 EN10228-1:1999 ISO 9934
- Light weight ergonomic design reduces operator muscle fatigue
- Magnetic pole feet of the movable joints can make good contact with any shape of parts



SPECIFICATION

Code	MPI-M510-P	MPI-M510-K	MPI-M510-B
Amps	AC 2.5A		
Sensitivity	15/100 engraved groove clearly displayed on A1 standard sensitivity test piece		
Duty cycle	>50% maximum excitation time 30 seconds		
Lifting Power	≥4.5kg (44N)		
Magnetic pole spacing	50-195mm		
Power supply	AC220V, 50Hz		
Power cord	europaean type	british type	brazilian type
Operation temperature	-10-40°C		
Dimension (L×W×H)	220×42×175mm		
Weight	2.3kg		

STANDARD DELIVERY

Main unit	1 pc
-----------	------

ADJUSTABLE FREQUENCY MAGNETIC POWDER FLOW DETECTOR CODE MPI-CX50



29

- Deep penetration of the magnetic field, which allows the detection of artificial cracks from the surface up to a depth of about 8 mm from the surface
- For workpieces made of ferromagnetic materials with thin paint, plating, or other coverings on the surface, flaw detection can be performed without any treatment
- Magnetization current using digital MCU to regulate phase inverter current, no demagnetization is required after flaw detection
- Low standby energy consumption, high efficiency, adjustable frequency
- Compact size, light weight, portable type



SPECIFICATION

Frequency	3Hz, 10Hz, 20Hz (adjustable)	
Sensitivity	15/100 clearly displayed on A1 sensitivity test piece (20Hz)	
Lifting power	≥44N (20Hz)	
White light power	2W	
Magnetic pole spacing	40~180mm	
Lithium battery	voltage	12V
	current	1~2.4A
	capacity	10000mAh
	life	4~6h
charging time	<6h	
Operation temperature	-10~40°C	
Dimension (L×W×H)	200×45×160mm	
Weight	2kg	

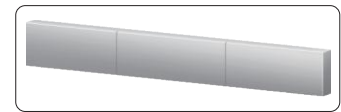

test block (included)

STANDARD DELIVERY

Main unit	1 pc
Lithium battery	1 pc
Power adapter	1 pc
Test block	1 pc
Fuse	2 pcs

CAN BE CUSTOMIZED ACCORDING TO CUSTOMER NEEDS

FLUORESCENT MAGNETIC POWDER FLAW DETECTOR CODE MPI-FX□□□



- Conform to standards GB/T15822.1~3 GB3721-83, JB/T8290-2011 ASTM E1444-2016
- Specialized in non-destructive testing of the whole surface of ferrous materials
- With automatic program, it can realize a series of semi-automatic actions such as workpiece clamping, spraying, 360° rotation, compound magnetization, demagnetization, and releasing
- It has high inspection efficiency, low labor intensity of operators, and reliable practicality
- Touch screen
- With magnetization abnormality alarm, to prevent the leakage of detection
- With independent stirring pump, to ensure that the magnetic powder does not precipitate
- Suitable for non-destructive testing of various parts in aviation, aerospace, military, railroad, automobile, metallurgy, petrochemical, shipbuilding, pressure vessel and other industries

SPECIFICATION

Circumferential magnetizing current	AC: 0~2000A
Longitudinal magnetization potential	AC: 0~12000AT
Electrode spacing	100~600mm adjustable (manual)
Magnetization sensitivity	15/50 clearly displayed on A sensitivity test piece
Duty cycle	≥25%, continuous magnetization time maximum 3s
Magnetization method	circumferential magnetization, longitudinal magnetization, compound magnetization
Clamping method	pneumatic clamping
Running mode	pneumatic/manual
Electrode plate	Ø160mm
Magnetizing coil	coil inner diameter Ø200mm two, coil turns 6 turns
Demagnetization	automatic attenuating demagnetization, residual magnetism ≤0.3mT
UV (light) Lux	≥2000uW/cm ² (calibration at a distance of 381mm)
Power supply	380V three-phase alternating current, 50Hz
Air supply	0.4~0.7MPa
Operation environment	temperature: -5~45°C, relative humidity: ≤90%
Dimension (L×W×H)	main unit: 2600×850×1700mm including darkroom dimension: 2800×1600×2200mm
Weight	700kg

STANDARD DELIVERY

Electrical control system	1 pc
Magnetized power system	2 pcs
Spray system	1 pc
Magnetic suspension recovery device	1 pc
Ultraviolet flaw detection lamp	1 pc
Demagnetization system	1 pc

MAGNETIC POWDER TYPE I TEST BLOCK CODE MPI-MTU3

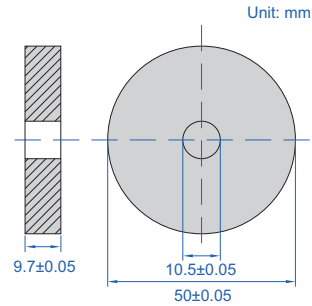

- Conform to standard ISO 9934-2: 2002
- The test block is a disc with natural cracks in the surface, it contains coarse cracks and fine cracks produced by grinding and stress corrosion
- The test block is permanently magnetized by a central conductor through the hole, evaluation of a detection media is made by visual or other methods

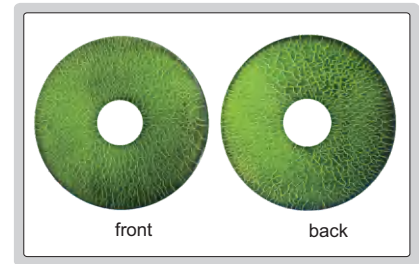

SPECIFICATION

Material	90MnCrV8
Surface hardness	63HRC~70HRC
Magnetization method	1000A magnetization of DC center conductor

UV FLAW DETECTION LIGHT CODE MPI-HD130



- UV-B content is 0
- No need to wait, instantly reaches 100% power
- Supplied with glass filter
- External surface temperature increase <math>< 5K (5^{\circ}C)</math> for continuous working

SPECIFICATION

UV (light) Lux	6000~11000 μ W/cm ²
UV light power	UV LED-3W
FLUX error	$\pm 10\%$ (at 0 $^{\circ}$ C~40 $^{\circ}$ C)
Lighting characteristics	center lighting
Wavelength	365nm \pm 3nm (UVA), at temperature 25 $^{\circ}$ C
Power supply	3.7V rechargeable lithium battery
Battery capacity	2600mAh
Charging time	2h~3h
Battery life	UV LED 3h~4h
Dimension	180 \times 47mm
Weight	260g (including battery)

STANDARD DELIVERY

Main unit	1 pc
Battery	2 pcs
Charger	1 pc



- UV-B content is 0
- Without preheating, instant start, instant on/off, no need to wait
- Supplied with glass filter
- External surface temperature increase <8K (8°C) for continuous working

RECHARGEABLE UV FLAW DETECTION LIGHT CODE MPI-HF360

goggles (included)



SPECIFICATION

UV (light) Lux	about 6000 μ W/cm ²
UV light power	UV LED-12VA
Covering area	diameter approximately 300mm (calibrated at 381mm distance)
FLUX error	\pm 10% (at 0°C~40°C)
White light content	\leq 20LUX
Lighting characteristics	center lighting
Wavelength	365nm \pm 3nm (UVA), at temperature 25°C
Power supply	12V rechargeable lithium battery
Battery capacity	3500mAh
Charging time	3~4h
Battery life	UV LED 5~6h
Dimension	175×75×170mm
Weight	750g (including battery)

STANDARD DELIVERY

Main unit	1 pc
Battery	2 pcs
Charger	1 pc
Goggles	1 pc

goggles (included)



- UV-B content is 0
- With UV and white light dual function, one hand switching
- Without preheating, instant start, instant on/off, no need to wait
- Supplied with glass filter
- External surface temperature increase <8K (8°C) for continuous working

RECHARGEABLE UV/WHITE LIGHT FLAW DETECTION LIGHT CODE MPI-HW369

29



SPECIFICATION

UV (light) Lux	>6000 μ W/cm ²
White light brightness	>1000LUX
Lamp power	UV LED-9VA, white light-3VA
Covering area	300mm (at 381mm distance)
FLUX error	\pm 10% (at 0°C~40°C)
White light content	\leq 20LUX
Lighting characteristics	center lighting
Wavelength	365nm \pm 3nm (UVA), at temperature 25°C
Power supply	12V rechargeable lithium battery
Battery capacity	3500mAh
Charging time	3h~4h
Battery life	UV LED 5h~6h, white light 7h
Dimension	175×75×170mm
Weight	750g (including battery)

STANDARD DELIVERY

Main unit	1 pc
Battery	2 pcs
Charger	1 pc
Goggles	1 pc

INTELLIGENT IMAGE UV FLAW DETECTION LIGHT CODE MPI-SC608



- UV-B/C content is 0
- Without preheating, instant start, instant on/off, no need to wait
- Continuous irradiation surface spot uniform, no dark areas, no point-like strong light source
- 13M UV-resistant specialized lens for high-definition photos and videos
- Precise measurement of small defects
- High-definition defects can be freely magnified up to 12 times (3 times optical magnification, 4 times electronic magnification)
- Android system, free to download applications
- Support WIFI, USB, Bluetooth data transmission function, and can realize real-time synchronization between light interface and computer screen
- Languages: Chinese, English, French, German, Japanese



measuring camera (optional)



goggles (included)



imaging

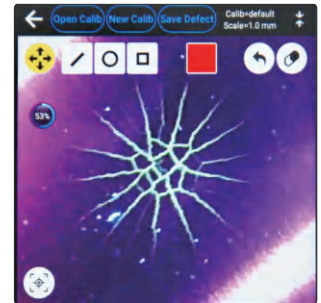

29

SPECIFICATION

UV (light) Lux	about 4000 μ W/cm ²
Light source	3 UV LED's, 1 white LED
Covering area	Ø180mm (at 381mm distance)
White light content	<5LUX
Minimum working distance	≤13cm
Camera pixels	13M
Display	3" touch LCD
Display resolution	720×720
Camera focus	auto focus or manual focus
White balance	adjust white balance automatically
Internal storage	32GB
Data transmission	USB, WIFI, Bluetooth
Operation system	Android 6.0
Power supply	rechargeable lithium battery ≥4hours, power adapter (for continuous use)
Dimension	175×80×180mm
Weight	880g (including battery)

STANDARD DELIVERY

Main unit	1 pc
Battery	2 pcs
Charger	1 pc
Power adapter	1 pc
Data cable	1 pc
Goggles	1 pc
4G USB flash disk	1 pc
Scerwdriver	1 pc

OPTIONAL ACCESSORY

Measuring camera	MPI-SC608-AW
------------------	--------------

SPECIFICATION (OPTIONAL)

Product	Code	Defect measurement range	Camera pixels	UV light	White light
measuring camera	MPI-SC608-AW	0.01-7mm	2M	about 14000 μ W/cm ²	about 2200LUX



PENETRATION STANDARD TEST BLOCK CODE ISU-PB3

- Comply with ASME standard requirements
- The test block shows the number and clarity of lines of radiating cracks to determine the sensitivity level
- Suitable for verifying the sensitivity and operational accuracy of penetrants, as well as for testing the corrosion of stainless steel materials by penetrants



SPECIFICATION

Type	JB/T6064 B3 type
Surface treatment	chrome plating
Material	stainless steel

STANDARD DELIVERY

B3 test block	1 pc
B3 test block display image	1 pc



PENETRATION STANDARD TEST BLOCK CODE ISU-PB5

- Meets NB/47013.5 and ASME standards
- This test block is a means of verifying the sensitivity and operational accuracy of the penetrant, and has a rough surface in the sandblasting area to verify the cleaning performance of the penetrant and the accuracy of the cleaning method. Its sensitivity is determined by the number of defects displayed and the diameter of each point in the radial domain. It is a functional standard test block



SPECIFICATION

Type	JB/T6064 B5 type
Surface treatment	chrome plating
Material	stainless steel

STANDARD DELIVERY

B5 test block	1 pc
B5 test block display image	1 pc

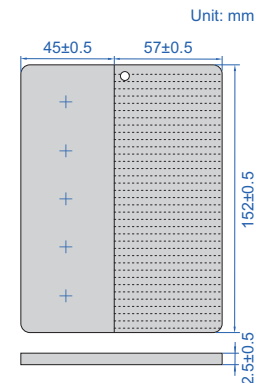

FLUORESCENT PENETRANT FLUID

- Conformity to standards AMS 2644, ASTM E1417
- Level 3 sensitivity, washable, high brightness, high contrast defect indication
- High water tolerance, high thermal stability, high UV stability
- High flash point, low toxicity, low volatility, low odor
- Low biological and environmental load

Code	Description	Sensitivity	Package/barrel
IPT-ZP1300	<ol style="list-style-type: none"> Fast drying, no residue, not easy to cause over-cleaning Suitable for aerospace parts, turbine blades, welded parts and ceramics, glass, plastic and other surface defects inspection Can be used in conjunction with imaging agents 	Level 3	18L



FLUORESCENT MAGNETIC POWDER CONCENTRATE

- Good storage stability, can be used immediately after slight shaking
- Dilution with water is all that is needed to prepare the magnetic suspension, no additional dispersant is required
- Good wettability, even dispersion of the suspension, high inspection accuracy
- Good dispersion stability, small change in the concentration of the suspension, can reduce the amount of use

Code	Description	Package/bottle
MPI-CC20	1. Suitable for surface and near-surface inspection of magnetizable parts (especially for on-line automatic inspection) 2. Usage: dilute the suspension to the recommended concentration (0.5~1.0g/L) to formulate a high-performance magnetic suspension	500ml



COMPOSITE MAGNETIC POWDER

- High sensitivity
- Composite magnetic particle eliminates the need for additional rust inhibitors, defoamers, and dispersants
- Clear, visible defect indication under UV light
- Excellent powder flowability
- Good dispersion stability
- Excellent surface wettability

Code	Description	Package/cans
MPI-CP30	1. Suitable for surface and near-surface inspection of magnetizable parts 2. Usage: simply mix and dilute the magnetic powder to the recommended concentration (3-7g/L) to form a high performance magnetic suspension	1kg



29

INDUSTRIAL VIEWING LAMP CODE RXT-F290

- LED light source, high brightness, uniform light emission, long life use
- Stepless adjustable brightness, 2%-100% wide range dimming
- Aluminum alloy case, good heat dissipation, low heat generation without damaging the film
- Bearing fan, high RPM, low noise, fast heat discharge
- No need to warm up, suitable for frequent switching of the occasions for film evaluation

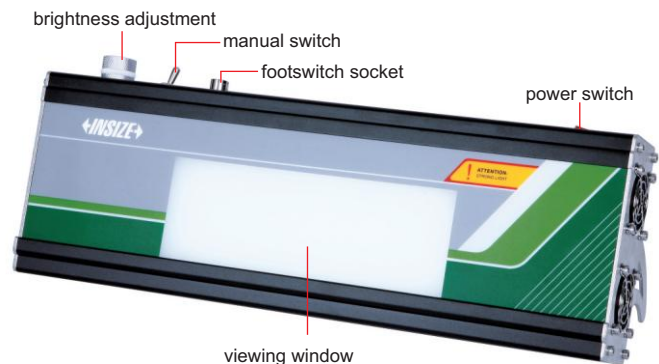

SPECIFICATION

Brightness	170000cd/m ² (500000LUX)
LED quantity	280pcs
Observable blackness	4.2D
Maximum area of viewing window	220×75mm
Power consumption	100W
Power supply	100~240V, 50/60Hz
Dimension	456×154×68mm
Weight	3.5kg

STANDARD DELIVERY

Main unit	1 pc
Light barrier	1 pc
Fuse	2 pcs
Wired footswitch	1 pc

OPTIONAL ACCESSORY

Wireless footswitch	RXT-F290-WF
---------------------	-------------



wireless footswitch (optional)



VIDEO

BLACK AND WHITE DENSITOMETER CODE RXT-BM301

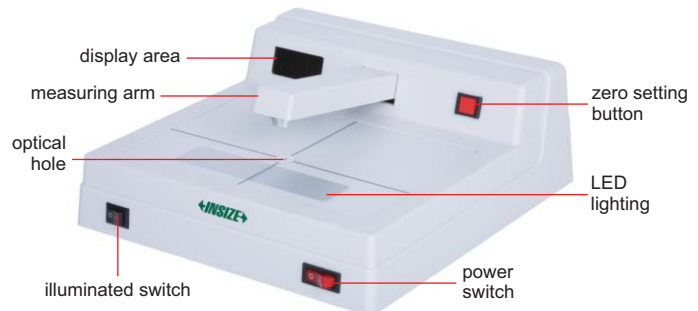

- With accurate reading, good stability, easy to operate
- Small size, light weight, 27 LED lighting source, good shock resistance
- Comes with calibration software and standard black and white density film, allowing self calibration of instruments
- Suitable for industries such as non-destructive testing, photosensitive materials, printing, etc.

SPECIFICATION

Blackness range	D=0.00~5.00
Reading stability	±0.02
Accuracy	±0.02 (0.0<D≤2.0) ±1% (2.0<D≤4.0) ±0.05 (4.0<D≤5.0)
Optical aperture	Ø2mm
Sampling time	0.8s
Display form	three-digit display
Interface	RS232 (optional accessory USB cable)
Operation environment	0°C~40°C, relative humidity≤85%
Power supply	220V, 50/60Hz
Dimension	260×265×110mm
Weight	2.1kg

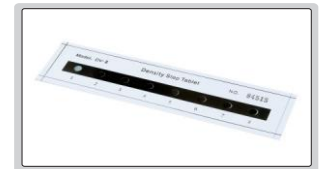

black and white density film
(0.0~5.0, included)

STANDARD DELIVERY

Main unit	1 pc
Black and white density film (0.0~5.0)	1 pc
USB flash disk	1 pc
RS232 cable	1 pc

OPTIONAL ACCESSORY

USB cable	RXT-BM301-CA
------------------	--------------

CAN BE CUSTOMIZED ACCORDING
TO CUSTOMER NEEDS



VIDEO

WIRE ROPE FLAW DETECTOR CODE EST

computer is not included



real-time alarm

transducer
(can be customized according to customer needs)

To be continued

Continued from previous page

- On-line detection of wire rope internal and external wire breakage, abrasion, corrosion, deformation, loose strands, jumping wire, material changes and other defects
- The test results report can meet the standards of different industries at the same time with the number of broken wires and broken wires broken area and the ratio of the total area of broken wires in the form of display
- The use of computer USB interface direct sampling processing analysis, with online sound and light alarms and real-time display of the results of the function
- The sensor's circular structure, circumferential encirclement, and axial magnetization instantly magnetize the wire rope to saturation
- Stable work, reliable performance, high detection precision, strong anti-interference performance, accurate data
- Suitable for use in mines, ropeways, lifting equipment, elevators, port machinery, cable-stayed bridges, etc.



parameter setting

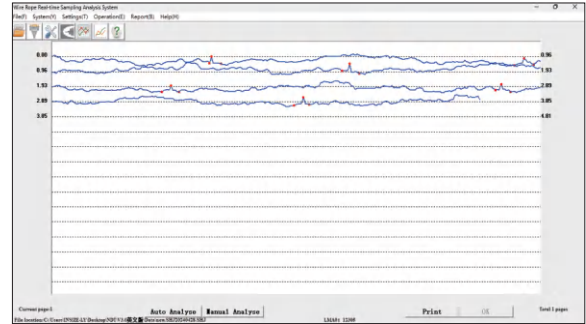

sampling analysis

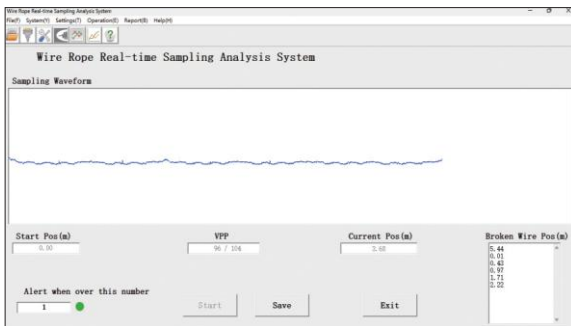

real-time detection alarm

No.	Wire broken position	Broken wire count	Total count in the lay pitch
1	0.305	1	1
2	0.629	1	1
3	1.549	1	1
4	2.262	1	1
5	2.889	1	1
6	3.384	1	1

test report

SPECIFICATION

Detection range	Ø1.5~300mm (can be customized according to customer needs)
Detection efficiency	0.0~6.0m/s (relative speed between sensor and wire rope)
Optimal detection efficiency	0.3~1.0m/s
Allowable interval	0~15mm (allowable interval between guide sleeve and wire rope)
Optimal interval	2~6mm
Qualitative accuracy of wire breakage	99.99%
Tolerance on the number of broken wires	allow one root or one equivalent of algorithmic differences
Sensitivity error	±0.055%
Accuracy error	±0.2%
Length error	±0.2%
Power supply	power adapter
Operation condition	temperature: -20~50°C humidity: ≤85% pressure: 86kPa~106kPa
Weight	<10kg

STANDARD DELIVERY

Main unit (transducer)	1 pc
Real-time alarm	1 pc
9355 signal connection line	1 pc
USB transmission cable	1 pc
Flexible traction safety rope	1 pc
Software USB flash disk	1 pc



Handheld XRF Alloy Analyzers
Page 916



Handheld LIBS Spectrometers
Page 917-918



Handheld Raman Spectrometers
Page 919-920



Spark Direct Reading Spectrometers
Page 921-930



**X-Ray Fluorescence Spectrometers/
Plating Thickness Instruments**
Page 931-933



**Standard Sheets For XRF Plating
Thickness Instruments**
Page 934



**Standard Samples For Spectral
Analysis**
Page 935-936



Spectral Sample Grinders
Page 936



**Fourier Transform Infrared
Spectrometers**
Page 937



Carbon And Sulfur Analyzers
Page 938



Gas Chromatographies
Page 939-941



Liquid Chromatographies
Page 942-944

INSTRUMENT SELECTION TABLE

Application	Name	Code	Analysis material	Analysis range	Non-destructive	Desktop	Handhold
Component analysis	spark direct reading spectrometer	OES-T350	metal	content of Li to U element		√	
		OES-R420				√	
		OES-P200				√	
	LIBS spectrometer	HLS-B410		content of Mg to U element			√
	carbon and sulfur analyze	CSA-R300	solid materials	content of C and S in metal, ore, ceramic, etc.		√	
	XRF spectrometer	HSM-A310	metal	content of Ti to U element	√		√
				XRF-PT230	content of S to U element	√	√
XRF-B210		metal and organic materials	content of Ti to U element in metal, plastic, rubber, etc.	√	√		
			XRF-VF300	content of Na to U element in metal, plastic, rubber, etc.	√	√	
Oil analysis	Oil spectrometer	OES-OL800	oil	analyse of metal impurities in oil during use to judge its pollution level		√	
Plating measurement	XRF spectrometer	XRF-B210	metal plating	thickness of Ti to U metal plating on metal or non-metal substrates	√	√	
		XRF-PT230		thickness of Li to U metal plating on metal or non-metal substrates	√	√	
		XRF-VF300		thickness of Li to U metal plating on metal or non-metal substrates	√	√	
Compound qualitative analysis	Raman spectrometer	HHL-R240	solid materials and liquid	content of drug, compound, biomolecule, jewellery, etc.	√		√
		HHL-S360		content of plastics, drug, compound, biomolecule	√		√
	infrared spectrometer	FTI-A170		content of compound, biomolecule, polymer, etc.	√	√	
Compound quantitative analysis	gas chromatography	GCT-2400	organic materials	4 o-benzenes in RoHS 2.0 (DEBP, BBP, DBP, DIBP)		√	
		GCT-3600	liquid and gas	compound of small molecule, volatile, good thermal stability		√	
	liquid chromatography	HLC-3000	liquid	compound of macromolecule, non-volatile, poor thermal stability		√	
	ion chromatography	HLZ-1000		cation: Li ⁺ , Na ⁺ , etc. anion: NO ₃ ⁻ , Cl ⁻ , etc.		√	



**POPULAR
MODEL**

HANDHELD XRF ALLOY ANALYZER CODE HSM-A310

test interface

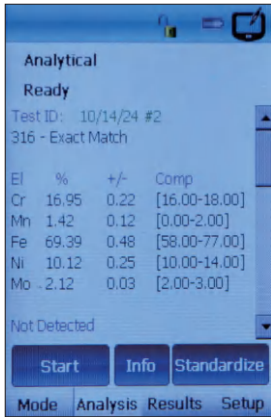

spectral analysis

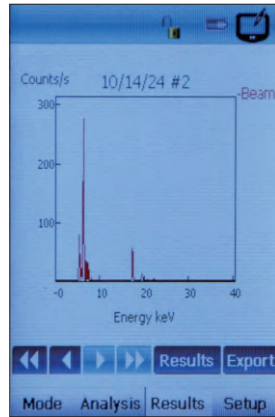

- Fast and non-destructive test to identify alloy grade and composition
- For iron-based alloys (stainless steels, chromium/molybdenum alloys, low alloy steels, tool steels, seamless steels), nickel-based alloys, cobalt-based alloys, titanium-based alloys, copper-based alloys, high-temperature alloys (molybdenum/tungsten alloys), aluminium-based alloys

SPECIFICATION

Excitation source	35kV/200μA, Ag target, integrated end window, micro X-ray tube and high voltage, power supply matching power ≥4W
Detector	Si-PIN, window area 25mm ²
Elemental analysis range	K, Ca, Ti, V, Cr, Mn, Fe, Co, Ni, Cu, Zn, As, Se, Rb, Sr, Zr, Nb, Mo, Ru, Rh, Pd, Ag, Cd, Sn, Sb, Ba, Ta, Hf, W, Re, Ir, Pt, Au, Hg, Pb, Bi
Alloy analysis mode	<ol style="list-style-type: none"> 1. iron-based alloys (stainless steels, chromium/molybdenum alloys, low alloy steels, tool steels, seamless steels), nickel-based alloys, cobalt-based alloys, titanium-based alloys, copper-based alloys, molybdenum/tungsten-based alloys, aluminium-based alloys 2. comes with 288 commonly used alloy grades 3. can create your own grade database
Display	3.5-inch LCD touch screen, clearly visible in all light conditions
Memory	built-in 8G, storage data, >40000 groups
Data transmission	data transmission via mobile phone shared WIFI with mobile phone app
Battery	6600mAh lithium battery, for 4 hours working time
System	Windows
Security protection	air-test protection against untargeted operation
Work environment	temperature: -20~40°C, relative humidity: 10%~80%
Dimension	250×265×85mm
Weight	1.3kg

STANDARD DELIVERY

Main unit	1 pc
Power adapter	1 pc
Charger	1 pc
Battery	2 pcs
Window protection film	5 pcs
316 stainless steel standard block	1 pc



316 stainless steel standard block (included)



window protection film (included)

HANDHELD LIBS SPECTROMETER CODE HLS-B410

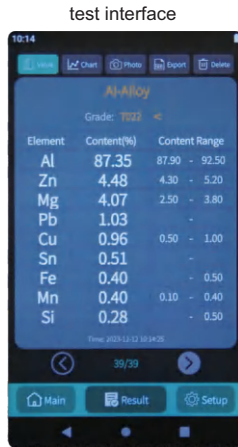

POPULAR
MODEL

EYE SAFE LASER

LASER CLASS
CLASS I

NO RADIATION

IP54
WATERPROOF



- Widely used in metallurgy, casting, steel, non-ferrous metals and scrap metal recycling, etc.
- LIBS is a technique that uses laser light on the sample's surface to excite outer electrons and generate a plasma, analyzing its elemental composition
- Ability to quickly analyze the metal elements of materials for quantitative characterization and grade differentiation
- Ability to accurately analyse light elements such as Al, Si, Mg, etc.
- No radiation, faster, more accurate, eye-safe handheld spectrometer
- The instrument includes standard metal grade database, ability to create user-owned metal grade database
- Compact size, lightweight, replaceable batteries, long battery life
- IP54 dust/waterproof

30

SPECIFICATION

Application	alloy analysis	can be used for almost all alloys, including scrap metal, high temperature alloys, alloy steel, stainless steel, tool steel, chromium molybdenum steel, aluminum alloys, nickel alloys, titanium alloys, cobalt alloys, cupric alloys, precious metals, zinc alloys, anomalous alloys, au-zirconium alloys, mixed alloys, etc.
	material properties identification (PMI)	can be used for quality control in the metal fabrication and processing industry to analyze material composition and identify alloy grades for a wide range of materials including critical missing pieces, raw materials, and welded seams
Operative system	android	
Touch panel	5", 720×1280, Multi-Touch, adjustable brightness	
Light source	pulsed laser	
Wavelength	1535nm	
Laser life	1 billion times	
Laser class	class I	
Detection limit	0.05%	
Repeatability	major element RSD<1%, nonmajor element RSD<5%	
Analysis time	<5s	
Work distance	fit to probe plane	
Analysis environment	no protective gas required, direct analysis in ambient air	
View window material	sapphire	
Memory	16G	
Data export format	PDF, xlsx (photos available)	
Data transmission	USB, flash drive (type C)	
Protection class	IP54	
Battery	3300mAh lithium battery	
Work time	8h	
Work power	10W	
Operation temperature	-10~40°C	
Dimension (L×W×H)	290×300×90mm	
Weight	1750g	

To be continued

Continued from previous page

STANDARD DELIVERY

Main unit	1 pc
Battery	2 pcs
Charger	1 pc
Sanding paper (HLS-B410-SP30)	20 pcs
Iron base calibration foil	2 pcs
Aluminum base calibration foil	2 pcs
Copper base calibration foil	2 pcs
Wavelength base calibration foil	1 pc



wavelength calibration foil (included)



iron base calibration foils (included)



aluminum base calibration foils (included)



copper base calibration foils (included)



STANDARD DATABASE

Alloy type	Elemental range
Iron Alloy	Fe, Cr, Ni, Mn, Cu, V, Mo, Si, Ti, Co, etc.
Aluminum Alloy	Al, Cr, Ni, Si, Mg, Ti, Fe, Cu, Sn, Pb, Zn, Zr, Be, Sr, Sc, etc.
Copper Alloy	Cu, Fe, Al, Mn, Sn, Pb, Zn, Ni, etc.

OPTIONAL DATABASE

Alloy type	Database number	Elemental range
Nickel Alloy	A1	Ni, Cr, Fe, Nb, Mo, Ti, Al, Mn, Cu, etc.
Titanium Alloy	A2	Ti, Al, V, Fe, Cr, Mo, Sn, Mn, Zr, Nb, Si, Cu, etc.
Magnesium Alloy	A3	Mg, Si, Cu, Mn, Zn, Zr, Al, Y, Be, Ni, Fe, etc.
Au	A4	Au, Ag, Zn, Ni, Pd, Cu, Co, In, etc.
Ag	A5	Ag, Cu, Zn, Cd, Ni, etc.
Pt	A6	Pt, Pd, Ag, Cu, Ni, Zn, Co, Ru, Pb, Cr, Au, etc.
Pd	A7	Pd, Cu, Ni, Zn, Fe, Co, Ag, As, Pb, Cr, etc.

COMPARISON TABLE

HANDHELD XRF ALLOY ANALYZER HSM-A310	HANDHELD LIBS SPECTROMETER HLS-B410
	
non-destructive testing	microdestructive testing, generates a spark point of 1mm ²
suitable for detection of high atomic number elements such as Mn, Fe, Cu, Mo, etc.	suitable for detection of low atomic number elements such as Mg, Al, Si, etc.
suitable for detection of stainless steels, high-temperature alloy steels, nickel-based alloys, cobalt-based alloys and special alloys made of zirconium, tungsten or tantalum	suitable for detection of aluminium alloys, magnesium alloys and low alloy steels
samples can be analyzed directly	samples need to be grinded to remove the oxide layer
meets radiation safety standards	without radiation

HANDHELD RAMAN SPECTROMETER (BASIC TYPE) CODE HHL-R240



- One-touch operation, non-destructive, fast detection and identification
- Equipped with raman spectral recognition algorithms, including standard spectra of up to 10,000 kinds of substances
- Supports analysis of pure substances and mixtures, with the ability to create user-owned database
- 5.5" screen and dual cameras to record the inspection site at all times
- Test results support export PDF reports
- Ultra-light weight, suitable for one-handed operation, easy to carry, built-in lithium battery
- 4-6 hours of long battery life

30

SPECIFICATION

Operative system	Android
Excitation wavelength	785±0.5nm
Wavenumber range	200~4000cm ⁻¹
Resolution	10cm ⁻¹
Touch panel	5.5", 1920×1080, Multi-Touch
Communication Interface	USB type-C
Fields of application	drugs: heroin, virus, cocaine, ketamine, etc.
	predisposition to manufacture: ephedrine, trichloromethane, ether, etc.
	explosives: TNT, RDX, TATP, ammonium nitrate, etc.
	hazardous chemicals: sulphuric acid, petrol, nitric acid, toluene, etc.
	food and drugs: pesticide residues, illegal additives, pharmaceutical excipients, etc.
	jewellery: diamonds, onyx, jade, etc.
Report output	supports export of multi-information test reports (test results, mapping information, photo forensics, etc.)
Battery	5200mAh lithium battery
Work hours	4-6h
Operation temperature	-20~50°C
Dimension	172×85×30mm
Weight	500g

STANDARD DELIVERY

Main unit	1 pc
Power cable	1 pc
Solid probe	1 pc
Liquid cuvette	1 pc



HANDHELD RAMAN SPECTROMETER (ADVANCED TYPE) CODE HHL-S360

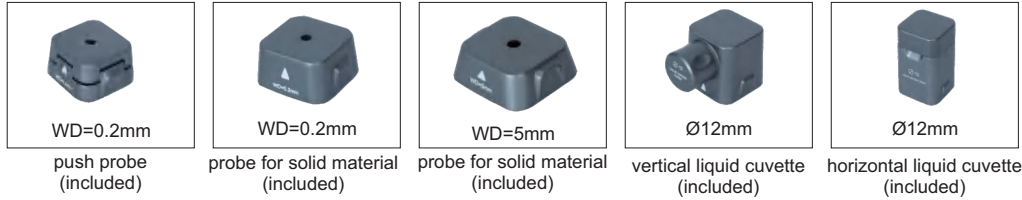

interchangeable probe



- Widely used in industry, medicine, environmental protection, food, public security, defense, etc.
- For the qualitative identification of inorganic and organic substances in various forms
- The 1064nm wavelength has the unique advantage of avoiding fluorescence interference
- Plastic types can be clearly distinguished, with the ability to create user-owned database
- Different sizes of probes and lenses to meet the testing of various samples
- Account privileges can be set to prevent unauthorized disclosure of data
- Compact size, lightweight, replaceable batteries, long battery life

SPECIFICATION

Operative system	android
Wavelength	1064nm
Wavenumber range	200~2500cm ⁻¹
Laser power	0~500mW adjustable
Resolution	14cm ⁻¹
Focus length	f=10mm*
Touch panel	6.3", 1920×1080, multi-touch
Laser class	class 3B
Fields of application	plastics: PP, PS, PVC, PA, ABS, etc.
	drugs: heroin, methamphetamine, cocaine, ketamine, fentanyl, alprazolam, etc.
	food safety: food additives, pesticide and veterinary drug residues, illegal additives, etc.
	gemstones and minerals: authenticity of gemstones, color identification, inclusions analysis, etc.
	petrochemicals: oil quality analysis, chemical raw materials, intermediate by-products, etc.
	pharmaceutical industry: identification of raw materials and excipients, identification of Chinese medicine additives, qualitative identification of drugs, etc.
Report output	others: scientific archaeology, biomedical diagnostics, environmental protection, etc.
Communication Interface	supports export of multi-information test reports (test results, mapping information, photo forensics, etc.)
Battery	bluetooth, WIFI
Work hours	5800mAh lithium battery
Operation temperature	4-6h
Dimension (L×W×H)	-20~50°C
Weight	209×95×55mm
	1350g

*Interchangeable focus lens with a focal length of 15mm

STANDARD DELIVERY

Main unit	1 pc
Battery	2 pc
Charger	1 pc
Sample spoon	1 pc
Disposable droppers	5 pcs
Focus lens (f=15mm)	1 pc
Vertical liquid cuvette (Ø12mm)	1 pc
Horizontal liquid cuvette (Ø12mm)	1 pc
Push probe (WD=0.2mm)	1 pc
Probe for solid material (WD=0.2mm)	1 pc
Probe for solid material (WD=5mm)	1 pc

The red curve is the 1064nm Raman spectrum, the peaks are clearly visible, and it is highly resistant to fluorescence interference. The black curve is the 785nm Raman spectrum, with large fluorescence interference.

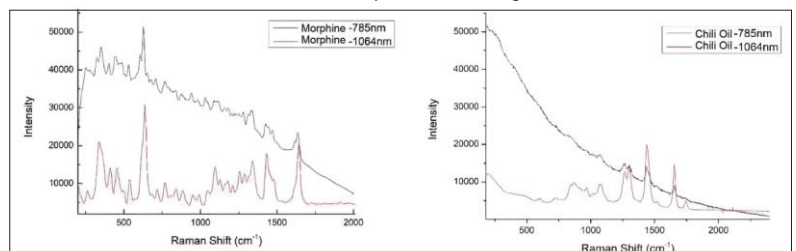

SPARK DIRECT READING SPECTROMETER (STANDARD TYPE) CODE OES-R420



- Widely used in metallurgy, casting, machinery, iron and steel and non-ferrous metal industries, etc.
- Can be used for sample analysis of metals and their alloys such as Fe, Al, Cu, Ni, Co, Mg, Ti, Zn, Pb, Sn, Mn, etc.
- It can automatically calibrate the pixel drift to ensure the stability of the optical system
- Fractional exposure is used to lower the detection limit of trace elements
- Equipped with a coaxial spinning air excitation stage, pressurized self-purge, excitation for thousands of times without cleaning
- Supports intelligent grade recognition, automatic carbon equivalent calculation, etc.
- The software is available in multiple languages (Chinese, English, German, Spanish)

30

SPECIFICATION

Curves	standard curve	carbon steel/low and medium alloy steel (A1), plain stainless steel (A2), Al-Si-Cu alloy (B1)
	customized curve	curves can be added or customized for special base materials (Mg, Ti, Pb, Sn, Mn, etc.)
Optical system	detector	multiple CCD detectors, unlimited maximum number of detection channels
	optical system construction	paschen-runge construction, grating focal length 500mm, roland circle diameter: 500mm
	raster scribing	2700 lines/mm
	spectral range	160~500nm
	resolution	better than 0.01nm (line resolution 0.7407nm/mm, pixel resolution 0.005926nm)
	pixel dimension	8 μ m
	dispersion	class I: 0.74nm/mm, class II: 0.37nm/mm
Excitation source	excitation frequency	20~1000Hz
	excitation current	90A
	excitation voltage	190V
Spark stand	discharge parameter	inductance: 120 μ H, resistance: 3.5 Ω , capacitance: 5 μ F, voltage: 380V
	dimension	125 \times 95mm, max. load 50kg
	lens	one-piece lens isolation valve
	excitation electrode	tungsten electrode
Gas supply	argon quality	purity: 99.999%, pressure: \geq 0.6MPa
	flow rate	tidal flushing mode, excitation: 8L/min, standby: 60ml/min
General analysis time		<40s
Data processing		after instrument excitation, acquisition and countback to independently control the integration exposure time of different CCDs
Work environment		20~25 $^{\circ}$ C, <70%RH
Power supply		AC220V, 50Hz, 1 \emptyset , 16A, 2.5KW, ground resistance <4 Ω
Dimension (L \times W \times H)		545 \times 380 \times 435mm
Weight		70kg

To be continued

Continued from previous page

STANDARD DELIVERY

Main unit	1 pc
Computer	1 set
Printer	1 pc
Voltage regulator	1 pc
Standardized sample	1 set
Electrode brush (OES-T350-BR)	1 set
Analysis and calibration software	1 set
Consumable and spare parts	1 set *

* Including polarimeter, pressure reducing valve, electrode brush and other consumable and spare parts



spectral sample grinder (optional)



lathe (optional)

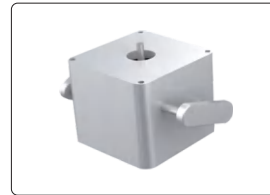

small sample fixture (optional)



gasket (optional)

OPTIONAL ACCESSORY

Spectral sample grinder	OES-MY100	Ø350mm, 380V
Lathe	OES-R420-LATHE	220×300mm, 220V
Small sample fixture	OES-R420-RODLIKE	Ø3.1~7mm regular bar sample
	OES-R420-FILIFORM	Ø0.5~3mm filament sample
Gasket	OES-R420-GASKET1	copper, ID6mm
	OES-R420-GASKET2	copper, ID8mm
	OES-R420-GASKET3	boron nitride, ID4mm
	OES-R420-GASKET4	boron nitride, ID6mm

30

IRON BASE CURVES

Curve number	A1	A2	A3	A4	A5
Elemental content (%)	Medium and * low alloy steel	Plain stainless steel	High speed tool steel	Cr-Mn stainless steel	Nodular iron **
C	0.0015-1.5	0.005-2.0	0.08-2.5	0.006-2.0	0.9-4.5
Si	0.005-2.0	0.005-2.0	0.005-2.0	0.003-2.0	0.1-5.5
Mn	0.005-2.5	0.002-2.5	0.005-2.0	2.0-25	0.005-2.5
P	0.001-0.1	0.002-0.1	0.003-0.1	0.003-0.2	0.003-1.0
S	0.001-0.1	0.001-0.1	0.001-0.1	0.003-0.1	0.003-0.2
Cr	0.001-5.0	5-35	0.01-7.9	0.005-30	0.005-5.0
Ni	0.002-5.0	0.004-30***	0.005-2.5	0.005-7	0.002-5.0
Mo	0.003-2.0	0.005-4.0	0.01-10.0	0.006-2.5	0.003-2.0
Cu	0.002-1.5	0.005-4.0	0.005-1.5	0.006-2.0	0.005-2.0
W	0.001-2.0	0.002-1.0	1.0-20.0	0.006-0.5	0.006-1.0
V	0.002-1.5	0.002-0.5	0.01-6.0	0.006-1.5	0.001-1.0
Ti	0.001-1.0	0.003-1.0	0.004-0.5	0.003-1.0	0.001-0.5
Nb	0.001-0.5	0.005-3.0	0.002-1.0	0.006-3.0	0.002-1.0
Al	0.001-1.5	0.004-1.5	0.005-0.2	0.004-0.5	0.001-0.4
Mg	—	—	—	—	0.001-0.1
Ce	—	—	—	—	0.001-0.1
Zr	0.004-0.5	—	—	—	0.003-0.1
Co	0.001-0.5	0.003-0.5	0.006-10	0.003-0.5	0.001-0.2
B	0.0008-0.02	0.002-0.02	—	0.002-0.02	0.003-0.2
Fe	REF	REF	REF	REF	REF
Description	La, As, Pb, Sn, Sb, Bi, Ca, Zn, Se, etc. in iron base can be customized				

* Including carbon steel curve

** Nodular iron samples are required to be whitening treated samples

*** Stainless steel in the nickel content of the standard configuration for the 0.004-30%, can be extended up to 40% according to requirements

To be continued

Continued from previous page

ALUMINUM BASE CURVES

Curve number	B1	B2	B3	B4
Elemental content (%)	Al-Si-Cu	Low-Al	Al-Mg-Si	Al-Zn
Cd	0.002-0.25	0.001-0.2	0.002-0.2	0.002-0.2
Cr	0.002-0.5	0.002-0.4	0.002-0.5	0.005-0.5
Cu	0.5-8.0	0.002-1.0	0.002-2.0	0.01-3.0
Fe	0.005-2.0	0.002-1.5	0.005-1.5	0.03-1.5
Mg	0.005-2.0	0.002-1.5	0.005-15.0	0.01-4.5
Mn	0.005-1.0	0.001-0.5	0.005-1.0	0.01-1.0
Ni	0.005-1.5	0.003-0.5	0.005-1.0	0.01-1.0
P	0.005-0.02	0.005-0.02	0.005-0.02	0.005-0.02
Pb	0.005-0.4	0.002-0.2	0.005-0.5	0.005-0.2
Si	1.0-16.0	0.005-1.5	0.01-25.0	0.01-1.0
Sn	0.0005-1.0	0.003-0.2	0.005-0.5	0.005-0.2
Ti	0.003-0.5	0.003-0.3	0.003-0.5	0.003-0.5
Zn	0.005-3.0	0.005-1.5	0.01-3.0	0.01-10.0
Al	REF	REF	REF	REF
Description	Sb, Sr, V, Zr, Ag, As, B, Be, Ca, Ce, Ga, Co, etc. in aluminum base can be customized			

NICKEL BASE CURVES

Curve number	D1	D2	D3	D4
Elemental content (%)	Nimonic alloy	Inconel alloy	Monel alloy	Hartz alloy
Al	0.005-6.0	0.005-6.0	0.005-4.5	0.005-1.0
C	0.005-0.3	0.005-0.2	0.005-0.5	0.005-0.25
Co	0.01-20.0	0.005-1.0	0.005-0.5	0.005-3.0
Cr	8.0-25.0	10.0-25.0	0.005-0.5	15.0-25.0
Cu	0.005-0.5	0.005-0.5	20.0-32.0	0.005-1.5
Fe	0.015-3.5	0.01-20.0	0.005-4.0	0.5-20.0
Mg	0.005-0.05	0.005-0.05	0.005-0.1	–
Mn	0.005-1.2	0.005-1.2	0.005-3.0	0.005-1.5
Mo	0.01-10.0	0.01-10.0	0.005-0.1	5.0-23.0
Nb	0.005-0.5	0.005-7.0	0.005-0.5	–
Si	0.005-1.0	0.005-0.5	0.005-4.5	0.005-1.3
Ti	0.005-6.0	0.005-3.0	0.005-1.5	0.005-0.5
V	0.005-0.6	0.005-0.5	–	0.005-0.5
W	0.002-4.5	0.005-0.5	–	0.5-6.0
Zr	0.005-0.15	0.005-0.05	0.005-0.1	–
Ni	REF	REF	REF	REF
Description	P, S, Pb, Ce, B, etc. in nickel base can be customized			

COPPER BASE CURVES

Curve number	C1	C2	C3	C4	C5	C6	C7
Elemental content (%)	Zn-Brass	Pb-Brass	Sn-Bronze	P-Bronze	Al-Bronze	Cu-Ni alloy	Cu-Ni-Zn alloy
Al	0.001-0.5	0.05-1.0	0.001-0.2	0.001-0.1	0.5-12.0	0.001-0.5	0.001-0.1
As	0.003-0.2	0.003-0.3	0.003-0.2	0.003-0.2	0.003-0.1	0.003-0.05	0.003-0.1
Bi	0.002-0.01	0.002-0.01	0.002-0.1	–	–	0.001-0.02	0.001-0.01
Cd	0.001-0.15	–	0.001-0.01	–	–	–	–
Co	–	–	0.003-0.15	–	–	0.006-0.2	0.006-0.25
Fe	0.003-0.5	0.003-1.0	0.003-0.35	0.003-0.35	0.005-6.5	0.03-1.0	0.03-1.0
Mg	–	–	–	0.005-0.01	0.005-0.1	0.003-0.15	0.003-0.15
Mn	–	0.001-0.2	0.003-0.2	0.005-0.5	0.005-3.0	0.005-1.5	0.005-1.0
Ni	0.005-0.5	0.01-1.0	0.005-2.0	0.005-1.5	0.01-7.0	0.5-35.0	5.0-20.0
P	0.003-0.05	0.003-0.1	0.003-0.6	0.01-1.0	0.003-0.05	0.003-0.05	0.01-0.1
Pb	0.005-0.5	0.2-5.0	0.005-10.0	0.005-1.5	0.002-0.2	0.002-0.05	0.002-2.0
S	0.001-0.01	0.001-0.01	–	0.002-0.1	–	0.002-0.1	0.002-0.1
Sb	0.001-0.1	0.001-0.1	0.001-0.6	0.001-0.5	–	0.001-0.02	0.001-0.02
Si	0.001-0.2	0.001-0.2	0.004-0.15	0.004-0.15	0.004-0.5	0.002-0.2	0.002-1.0
Sn	0.005-0.1	0.005-1.0	0.01-12.0	0.1-12.0	0.005-0.3	0.005-0.1	0.005-0.2
Zn	0.5-42.0	0.5-42.0	0.005-12.0	0.002-1.5	0.003-2.0	0.005-1.0	10.0-35.0
Cr	–	–	–	–	0.001-0.1	–	–
Cu	REF	REF	REF	REF	REF	REF	REF
Description	Be, Ti, Te, Se, C, B, Au, Ag, etc. in copper base can be customized						

COBALT BASE CURVES

Curve number	E1	E2	E3	E4
Elemental content (%)	Co-Cr-W alloy	Co-Cr-Ni-W alloy	Co-Ni-Cr-Mo alloy	Co-Cr-Mo alloy
Al	0.005-0.48	0.005-0.48	0.005-0.48	0.005-0.48
C	0.005-1.0	0.005-1.0	0.005-0.5	0.005-0.5
Cr	18.0-31.0	18.0-31.0	18.0-31.0	18.0-31.0
Cu	0.005-0.3	0.005-0.3	0.005-0.05	0.005-0.05
Fe	0.005-9.0	0.005-3.0	0.03-1.0	0.005-3.0
Mn	0.005-2.0	0.005-2.0	0.005-0.3	0.005-1.0
Mo	0.005-1.5	0.005-1.0	1.0-10.0	1.0-8.5
Nb	0.005-4.2	0.005-0.5	0.005-0.5	0.005-0.5
Ni	0.005-3.0	8.0-25.0	10.0-36.0	0.005-5.0
Si	0.005-1.0	0.005-1.0	0.005-1.0	0.005-1.0
Ti	0.005-3.0	0.005-0.05	–	0.005-0.05
W	3.0-16.0	3.0-16.0	0.005-0.1	0.005-0.1
Co	REF	REF	REF	REF
Description	V, P, S, Ta, Sn, B, etc. in cobalt base can be customized			

ZINC BASE CURVES

Curve number	F1	F2
Elemental content (%)	Die-casting zinc alloy	Zinc-Aluminum alloy
Al	0.05-6.0	6.0-30.0
Cd	0.005-0.04	0.005-0.04
Cu	0.005-3.0	0.005-3.0
Fe	0.005-0.1	0.005-0.1
Mg	0.005-0.1	0.005-0.1
Ni	0.005-0.05	0.005-0.05
Pb	0.005-0.03	0.005-0.03
Si	0.005-0.05	0.005-0.05
Sn	0.005-0.01	0.005-0.02
Ti	0.005-0.3	0.005-0.3
Zn	REF	REF
Description	Sb, etc. in zinc base can be customized	



SPARK DIRECT READING SPECTROMETER (BASIC TYPE) CODE OES-T350



printer (included)



filter element (included)



AC voltage regulator (included)



calibration sample (included)



electrode brush (included)



pressure valve (included)



gray iron control sample (optional)



15# steel control sample (optional)

- Widely used in metallurgy, casting, scientific research, commodity inspection, automobile, shipbuilding, aviation, nuclear power, etc.
- Ability to analyze trace elements such as carbon (C), phosphorus (P), sulfur (S), etc.
- The analysis speed is fast, and the element composition of all channels is measured within 20 seconds
- Paschen-Runge structure with full wavelength coverage, the most concise and stable optical system structure
- Perfect aberration correction, so that the spectrometer has excellent resolution, minimize the cross interference of different elements
- Argon-filled optical chamber, effectively reducing the attenuation of P and S rays in the far ultraviolet region
- The software has automatic spectrum correction technology, can store database, trace historical data, output and print reports
- Report format can be customized, data can be sent out

STANDARD DELIVERY

Main unit	1 pc
Computer	1 pc
Software	1 pc
Printer	1 pc
Calibration sample	1 pc
Electrode brush (OES-T350-BR)	2 pcs
Filter element	2 pcs
AC voltage regulator	1 pc
Pressure valve	1 pc

OPTIONAL ACCESSORY

15# steel control sample	OES-KY235
Gray iron control sample	OES-KY282
Spectroscopic grinder	OES-MY100
Argon purifier	OES-T350-PURIFIER

To be continued

Continued from previous page

SPECIFICATION

Curves	standard curve	low alloy steel (A1), cast iron (A2), plain stainless steel (A3)
	customized curve	curves can be added or customized for special base materials (Ti, Pb, Sn, Co, etc.)
Optical system	optical structure	paschen-runge structure
	rowland circle of diameter	350mm
	wavelength range	160~510nm
	detector	multi high resolution CCD detectors
	pixel resolution	20pm
	full spectrum	cover the full range of element analysis
	light room temperature	34±0.5°C (be controlled automatically)
Spark source	type	digital arc and spark source/new plasma generator
	spark frequency	100~1000Hz
	plasma current	1~80A
	ignition voltage	>7000V
Spark stand	spray discharge electrode technology reduces argon consumption and improves argon use efficiency good heat dissipation, continuous excitation for 100 times, the temperature of the excitation table does not rise more than 5°C	
Operation temperature	10~30°C, 23±2°C is recommended	
Argon quality	99.999% high purity argon, argon pressure≥4MPa	
Argon consumption	5L/min during spark mode	
Operation humidity	20%~80%RH	
Power supply	AC220V, 50Hz	
Power consumption	excitation: 300W, stand by: 40W	
Dimension (L×W×H)	700×660×340mm	
Weight	30kg	

30

IRON BASE CURVES

Curve number	A1	A2	A3	A4	A5	A6	A7
Elemental content (%)	Low alloy steel	Cast iron*	stainless steels	High Mn steel	High Cr* cast iron	High speed tool steel	High Ni* cast iron
C	0.006-1.19	1.75-4.04	0.0035-1.0	0.0085-2.38	1.16-3.43	0.003-2.94	1.75-4.04
Si	0.013-3.86	0.2-3.88	0.095-2.41	0.091-1.69	0.055-2.48	0.014-0.967	0.2-3.88
Mn	0.034-2.2	0.08-1.67	0.131-16.13	5.3-22.96	0.201-1.95	0.018-0.846	0.08-6.72
P	0.0019-0.13	0.021-0.699	0.0057-0.065	0.0064-0.188	0.024-0.369	0.0038-0.098	0.0067-0.699
S	0.0009-0.364	0.003-0.22	0.0006-0.095	0.0047-0.108	0.0047-0.123	0.0005-0.076	0.003-0.22
Cr	0.016-4.83	0.021-2.48	6.8-32.58	0.084-29.22	1.17-33.9	0.023-14.16	0.021-2.56
Ni	0.0082-4.4	0.013-1.89	0.09-32.3	0.045-15.34	0.129-2.57	0.07-0.436	0.013-21.26
Mo	0.004-4.19	0.0018-1.08	0.026-6.09	0.0095-3.15	0.086-3.53	0.022-8	0.0011-1.08
Al	0.0021-1.27	0.0073-0.214	0.0057-0.403	0.009-0.403	-	0.032-0.128	0.0073-0.214
Cu	0.0032-0.8	0.018-1.83	0.014-4.22	0.025-1.9	0.154-1.57	0.018-0.364	0.018-7.46
Co	0.004-0.504	0.008-0.034	0.0067-0.69	0.007-0.107	-	0.014-12.3	0.0063-0.034
Ti	0.001-1.18	0.024-0.51	0.002-2.11	0.0041-0.545	0.08-0.3	0.003-1.47	0.024-0.51
Nb	0.004-1.04	0.023-0.576	0.024-2.41	0.0006-0.613	0.01-0.686	0.003-2.33	0.0006-0.576
V	0.0082-0.9	0.014-0.701	0.015-1.4	0.024-0.837	0.059-1.01	0.01-7.54	0.0085-0.701
W	0.005-2.07	0.023-0.574	0.0065-2.2	0.002-1.45	0.015-1.99	0.01-18.68	0.0002-0.574
Pb	0.003-0.26	0.002-0.105	0.0001-0.0037	0.0005-0.002	-	-	0.0022-0.105
Mg	-	0.0006-0.104	-	-	-	-	0.0006-0.104
B	0.0003-0.019	0.012-0.086	0.0007-0.016	0.0007-0.017	0.015-0.177	-	0.012-0.086
Sn	0.0016-0.039	0.0018-0.3	0.0007-0.054	0.0007-0.023	-	0.001-0.005	0.0003-0.3
Zn	-	0.0009-0.0045	0.0011-0.0084	-	-	-	0.0009-0.0045
As	0.007-0.174	0.0021-0.035	0.0013-0.03	0.0013-0.0116	-	-	0.0021-0.035
Bi	0.0019-0.021	-	0.00004-0.0029	0.0013-0.0029	-	-	-
Zr	0.004-0.57	-	-	-	-	0.003-0.01	-
Ca	0.0004-0.0015	-	0.0004-0.0010	0.0004-0.001	-	-	0.00035-0.2
Fe	REF	REF	REF	REF	REF	REF	REF

* Cast iron samples need to be whitened samples

To be continued



Continued from previous page

ALUMINUM BASE CURVES

Curve number	B1	B2	B3	B4	B5
Elemental content (%)	Al low alloy	Al-Si alloy	Al-Zn alloy	Al-Cu alloy	Al-Mg alloy
Si	0.0084-1.58	3.69-20.5	0.027-8.23	0.029-1.57	0.021-0.885
Fe	0.0066-1.26	0.026-1.9	0.049-0.749	0.066-1.61	0.074-0.718
Cu	0.0041-0.99	0.01-8.04	0.005-2.71	0.465-6.57	0.0078-0.308
Mn	0.011-2.38	0.019-0.967	0.047-0.821	0.05-1.5	0.0085-0.865
Mg	0.004-1.5	0.049-1.8	0.01-3.96	0.0079-2.68	0.624-10.32
Cr	0.043-0.36	0.004-0.28	0.087-0.349	0.0099-0.272	0.0093-0.349
Ni	0.0084-0.152	0.0051-1.77	0.012-0.188	0.0084-1.55	0.0015-0.239
Zn	0.003-0.367	0.0064-2.93	0.955-16.5	0.0028-0.728	0.0071-0.571
Ti	0.0021-0.175	0.0071-0.31	0.0059-0.205	0.006-0.415	0.006-0.3
Pb	0.0011-0.0192	0.0025-0.31	-	-	-
Bi	-	-	-	-	-
Ca	-	0.0006-0.034	-	-	-
Cd	-	0.0013-0.12	0.003-0.04	0.062-0.245	-
Co	-	0.003-0.043	-	-	-
Ga	0.012-0.045	0.0054-0.2	-	-	-
Sn	-	0.0024-0.5	-	-	-
Sr	-	0.0002-0.167	-	-	-
V	-	0.005-0.175	-	0.017-0.253	-
Zr	-	0.0043-0.193	0.0084-0.241	0.0058-0.301	-
Ag	-	-	-	-	-
Be	-	0.0047-0.21	-	-	0.00056-0.013
In	-	-	0.014-0.084	-	-
p	-	0.0018-0.0074	-	-	-
B	-	-	-	0.0076-0.056	-
Al	REF	REF	REF	REF	REF

30

COBALT BASE CURVES

Curve number	C1	C2	C3	C4	C5	C6	C7	C8
Elemental content (%)	Brass	Aluminum Bronze	Sn-Pb-Cu Alloy	Red Copper/Pure Copper	Chromium Bronze	Beryllium Bronze	Silicon Bronze	Mn Brass
Zn	3.06-41.76	0.18-1.46	0.064-13.79	0.0006-0.0138	0.0068-0.111	0.0068-0.111	0.04-2.2	25.97-41.06
Pb	0.0082-4.48	0.013-0.094	0.159-21.42	0.0005-0.0426	0.0046-0.0718	0.0016-0.0718	0.01-0.2	0.054-0.51
Sn	0.032-1.02	0.025-0.22	2.33-18.96	0.00026-0.133	0.0072-0.0324	0.0072-0.0324	0.086-2.45	-
Mn	0.0046-0.464	0.31-1.8	0.001-0.067	0.001-0.0056	-	-	0.086-2.45	0.33-3.08
Fe	0.016-0.579	0.62-5.62	0.0014-0.467	0.0017-0.0782	0.033-0.124	0.014-0.124	0.065-0.51	0.69-3.28
Ni	0.0019-0.421	0.56-5.95	0.061-1.931	0.0011-0.05	0.014-0.192	0.0066-0.314	0.1-3.96	-
Si	0.0012-0.0938	0.032-0.26	0.0008-0.04	0.00088-0.0272	0.0066-0.153	0.0066-0.153	0.25-4.21	-
Mg	-	-	-	-	0.0014-0.126	0.0014-0.126	-	-
Cr	-	-	-	0.74-0.79	0.424-1.5	0.0074-1.5	0.021-0.37	-
As	0.0053-0.1	-	0.0111-1.07	0.0003-0.0376	0.0048-0.066	0.0048-0.066	-	-
Sb	0.0017-0.029	-	0.001-0.589	0.0001-0.0182	-	-	-	-
Cd	-	-	-	0.001-0.0272	-	-	-	-
Bi	0.00076-0.0122	-	0.0119-0.13	0.001-0.0095	-	-	-	-
Ag	-	-	0.0016-0.495	0.003-0.199	-	-	-	-
Co	-	-	0.0051-0.443	-	-	0.01-2.36	-	-
Al	0.015-0.81	7.8-11.88	0.001-0.052	0.0009-0.0023	0.0017-0.0223	0.0017-0.093	0.003-0.1	-
P	0.0018-0.044	0.011-0.1	0.002-1.208	0.00092-0.0695	-	-	-	-
S	-	-	0.0012-0.091	0.0034-0.127	-	-	-	-
Zr	-	-	-	0.113-0.203	-	-	-	-
Be	-	-	-	-	-	0.583-2	-	-
Cu	REF	REF	REF	REF	REF	REF	REF	REF

To be continued

Continued from previous page

NICKEL BASE CURVES

Curve number	D1	D2	D3	D4	D5	D6
Elemental content (%)	Monel Alloy	Inconel Alloy	Hastelloy Alloy	GH30 Alloy	GH4169 Alloy	DZ125 Alloy
C	0.0494-0.13	0.01-0.169	0.01-0.169	0.137-0.241	-	0.0322-0.152
Si	0.146-2.52	0.036-0.85	0.2-0.85	0.311-0.895	-	0.016-0.042
Mn	0.993-1.437	0.05-1.19	0.249-1.19	0.156-0.777	-	0.0022-0.024
P	0.0106-0.019	0.0004-0.038	0.007-0.038	0.001-0.0152	-	0.0023-0.0024
S	0.0006-0.023	0.0002-0.034	0.0086-0.034	0.0034-0.0145	-	0.0005-0.0006
Cr	0.0057-0.2	14.86-29.5	15.42-19.71	16.81-20.56	14.87-22.21	6.57-19.62
Mo	0.0024-0.102	0.0025-20.91	15.59-20.91	-	2.29-4.03	0.63-4.32
Fe	1.053-2	1.2-18.51	2.6-7.3	0.229-1.780	-	0.022-1.023
W	-	0.0011-12.7	0.09-0.498	-	-	0.041-8.8
V	-	0.005-0.498	0.03-0.72	-	-	-
Al	0.0231-1.399	0.03-0.72	0.159-2.6	0.065-0.267	0.14-0.68	1.476-6.13
Co	0.032-0.156	0.0056-2.6	0.046-0.642	-	1.02-1.04	0.024-14.79
Cu	21.53-33	0.0072-0.642	-	0.082-0.245	0.0015-0.002	-
Nb	-	0.0039-5.16	-	-	3.85-6.79	0.028-2.04
Sn	-	-	-	-	-	-
Ta	-	-	-	-	-	2.74-4.82
Ti	0.064-1.005	0.017-0.93	0.06-0.264	-	0.59-1.42	0.62-5.1
B	-	0.0001-0.01	-	-	-	0.0062-0.0242
Mg	0.0026-0.0217	0.0021-0.022	-	-	-	-
Zr	-	0.0018-0.004	-	-	-	0.014-0.06
Pb	0.0004-0.02	-	-	-	-	-
Ni	REF	REF	REF	REF	43.89-60	REF

30

ZINC BASE CURVES

Curve number	E1	E2
Elemental content (%)	Pure Zn	Zn-Al Alloy
Al	0.00036-0.007	0.00036-27.4
Cd	0.00044-0.0132	0.00044-0.3
Cu	0.00012-0.004	0.00012-6.05
Fe	0.00012-0.004	0.00053-0.1
Mg	-	0.0014-0.179
Mn	-	0.001-1.39
Ni	-	0.0019-0.06
Pb	0.00045-0.0152	0.00045-2.87
Sb	-	0.0012-0.309
Sn	0.0004-0.0033	0.0004-2.38
Ti	-	0.0008-0.278
Si	-	0.0013-0.0191
Cr	-	0.0007-0.142
Ag	-	-
Bi	-	0.0027-0.027
Fe	REF	REF

MAGNESIUM BASE CURVES

Curve number	F1	F2
Elemental content (%)	Pure Mg	Mg/Al/Mn/Zn Alloy
Al	0.005-1.06	1.09-11.02
Zn	0.00044-0.0132	0.0068-4.1
Mn	0.017-0.148	0.02-0.61
Si	0.012-0.062	0.019-1.83
Fe	0.0069-0.027	0.0012-0.033
Cu	0.00097-0.025	0.00072-0.291
Ni	0.00026-0.0052	0.00042-0.02
Be	-	0.00011-0.0029
Ti	0.0001-0.0025	-
Pb	0.0011-0.037	-
Mg	REF	REF



PORTABLE SPARK DIRECT READING SPECTROMETER CODE OES-P200



30

- Widely used in metallurgy, foundry, machining, automobile manufacturing, metal processing, furnace testing, etc.
- Ability to accurately analyze the elemental content of metallic materials such as C, P, S, B, etc.
- Automatically eliminates spectral drift due to temperature and pressure changes for accurate measurements
- Ability to add desired measurement curves without adding hardware
- Unique jet electrode technology, can save the use of argon gas, reduce the use of costs
- Replaceable lithium batteries, long battery life, hundreds of consecutive excitation times, to ensure the integrity of the field work
- The instrument is easy to carry, analysis is not limited, more convenient to complete outdoor work

STANDARD DELIVERY

Main unit	1 pc
Computer	1 pc
Analysis software	1 pc
Battery	2 pcs
Electrode brush (OES-T350-BR)	2 pcs
Pressure valve	1 pc
Mobile cart	1 pc
Charger	1 pc
Consumable and spare parts	1 set *



spectral sample grinder
(optional)

OPTIONAL ACCESSORY

Spectral sample grinder	OES-MY100
-------------------------	-----------

* Including quartz mirror, mirror paper, wrench, air connection line and other common consumables

To be continued

Continued from previous page

SPECIFICATION

Curves	standard curve	low and medium alloy steel (A1), chrome/nickel stainless steel (A2)
	customized curve	curves can be added or customized for special base materials (Ni, Mg, Zn, etc.)
Optical system	detector	high performance CMOS
	optical system construction	paschen-runge double optical chamber structure
	visible room temperature	34°C±0.5°C
	UV room temperature	34°C±0.5°C
	raster scribing	3600 lines/mm
	spectral range	165~580nm
	average resolution	≤10pm/pixel
	visible focal length	300mm
	ultraviolet focal length	298mm
Excitation source	light source	high energy excitation light source
	frequency	100~1000Hz
	excitation voltage	300V
	excitation current	400A
Excitation stand	gas supply	argon (purity≥99.9995%, pressure: ≥0.3MPa)
	flow rate	excitation: 3L/min, standby: 0.3L/min
	electrode	tungsten electrode
	purge	automatic cleaning
	design	self-compensating thermal deformation design
	analysis interval	2.8mm
Analysis software	1. automatic calibration control according to the given deviation and number of excitations 2. the analyzed results show the percentage, light intensity values, intensity ratios 3. electrode cleaning according to set data, display and corresponding deviation 4. ability to store and print test element results	
Transmission	DM9000A-based ethernet data transmission	
Work hours	standby: 10h, continuous excitation: 160~180 times	
Work environment	5~35°C	
Power supply	replaceable lithium battery, 24V	
Dimension (L×W×H)	840×700×1050mm	
Weight	50kg	

30

IRON BASE CURVES

Curve number	A1	A2	A3	A4	A5	A6	A7
Elemental content (%)	Low alloy steel	Cr/Ni stainless steel	High speed tool steel	High Mn steel	High Cr cast** iron	High Ni cast** iron	Cast iron**
C	0.006-1.3	0.008-2.5	0.08-2.2	0.5-2.4	0.9-3.4	1.2-3.8	1.8-4.5
Si	0.01-2.9	0.09-4.0	0.04-1.5	0.3-1.7	0.2-2.5	0.04-3.5	0.2-4.2
Mn	0.03-14	0.12-16	0.04-1.7	5.3-23	0.1-2.4	0.001-6.8	0.06-4.7
P	0.002-0.12	0.003-0.3	0.004-0.007	0.01-0.2	0.01-0.3	0.0015-0.56	0.02-0.8
S	0.002-0.46	0.001-0.4	0.001-0.06	0.006-0.11	0.01-0.15	0.0015-0.24	0.003-0.2
Cr	0.01-12.5	7.4-32	1.8-8.1	0.08-3.8	0.4-34	0.0015-9.1	0.03-2.8
Ni	0.004-4.4	0.8-40	0.07-0.55	0.04-3.5	0.05-2.75	0.9-36.6	0.05-5.1
Mo	0.004-1.76	0.08-4.2	0.02-9.4	0.1-2.0	0.1-4	0.0015-1.5	0.01-2.1
Al	0.003-0.5	0.005-1.7	0.005-1.6	0.008-0.12	—	—	0.002-0.25
Cu	0.002-0.7	0.05-4.5	0.04-0.5	0.02-0.6	0.06-1.5	0.005-0.3	0.06-2.0
Co	0.001-0.5	0.008-0.62	0.008-16	0.007-0.1	—	—	0.008-0.03
Ti	0.002-0.5	0.005-1.1	—	0.004-0.4	0.01-0.14	—	0.007-0.7
Nb	0.002-0.53	0.02-2.0	—	0.08-0.42	0.1-0.7	0.003-0.38	0.002-0.7
V	0.003-0.9	0.02-0.58	0.03-2.5	0.01-0.84	0.02-1.2	—	0.01-0.7
Ca	—	—	—	—	—	—	—
B	0.006-0.02	0.007-0.02	—	—	—	—	0.002-0.3
Sn	0.001-0.09	0.003-0.05	—	—	—	—	0.003-0.3
As	0.001-0.1	0.004-0.04	—	—	—	—	0.008-0.09
Sb	0.002-0.02	—	—	—	—	—	0.004-0.2
Fe	REF	REF	REF	REF	REF	REF	REF

** Cast iron samples need to be whitened samples

To be continued



Continued from previous page

ALUMINUM BASE CURVES

Curve number	B1	B2	B3	B4	B5
Elemental content (%)	Al low alloy	Al-Si alloy	Al-Zn alloy	Al-Cu alloy	Al-Mg-Si alloy
Si	0.01-1.63	0.02-24	0.02-9.4	0.02-7	0.02-2.3
Fe	0.01-1.65	0.02-4	0.03-1	0.05-1.9	0.07-0.80
Cu	0.002-1	0.005-6	0.01-4.3	0.01-13	0.07-1
Mn	0.001-1	0.005-1	0.02-1	0.05-1	0.03-2.4
Mg	0.002-1	0.01-1.5	0.01-4	0.01-2.7	0.006-10.2
Cr	0.001-0.15	0.005-0.5	0.01-0.4	0.01-0.14	0.01-0.4
Ni	0.001-0.16	0.02-2.5	0.01-0.2	0.01-2.3	0.005-0.25
Zn	0.002-0.5	0.005-3.5	0.01-12	0.05-3.5	0.01-1
Ti	0.001-0.15	0.005-0.4	0.005-0.3	0.001-0.2	0.007-0.3
Ca	–	0.002-0.03	–	–	–
Cd	0.01-0.3	0.001-0.3	0.002-0.3	0.01-0.3	0.01-0.3
Ga	0.002-0.06	0.005-0.2	–	–	0.009-0.02
Pb	0.02-0.5	0.005-0.5	0.005-0.5	0.01-0.5	0.001-0.5
Sb	–	0.005-0.4	–	–	–
Sn	0.01-0.2	0.003-0.5	0.005-0.2	0.02-0.3	0.007-0.2
V	0.004-0.05	0.005-0.2	0.005-0.03	0.01-0.03	0.002-0.03
Zr	0.001-0.12	0.005-0.2	0.01-0.3	0.001-0.2	0.003-0.12
P	–	0.002-0.005	–	–	–
Al	REF	REF	REF	REF	REF

30

COBALT BASE CURVES

Curve number	C1	C2	C3	C4	C5	C6	C7
Elemental content (%)	Brass	Copper	Al-Cu alloy	Beryllium bronze	Sn-Pb-Cu alloy	Pure copper	Si-Bronze
Zn	0.5-43.0	0.01-23.0	0.04-2.2	0.005-0.23	0.003-0.7	0.001-0.3	0.2-6.0
Pb	0.01-6.0	0.002-0.13	0.002-0.068	0.005-0.3	0.001-21	0.001-1.5	0.01-0.8
Sn	0.009-4.8	0.009-0.13	0.003-0.35	0.005-0.18	0.005-11.2	0.001-0.3	0.05-0.7
P	0.002-0.14	0.003-0.07	–	–	0.001-0.42	0.001-0.078	0.005-0.08
Mn	0.001-5.3	0.009-1.1	0.001-3.1	–	0.001-0.4	0.001-0.1	0.2-1.8
Fe	0.02-3.0	0.03-1.03	0.005-6.0	0.02-0.28	0.003-0.028	0.001-0.2	0.1-1.7
Ni	0.009-1.8	5.5-32.5	0.005-6.0	0.005-0.35	0.001-1.0	0.001-0.5	0.05-1.0
Si	0.001-4.6	0.009-0.46	0.004-0.3	0.02-0.3	0.002-0.009	0.001-0.055	1.5-5.0
Mg	0.001-0.01	0.003-0.14	–	0.003-0.7	–	0.001-0.01	–
Cr	0.001-0.2	–	–	–	–	0.001-0.081	–
As	0.001-0.2	0.003-0.05	–	–	0.004-0.2	0.005-0.3	–
Sb	0.001-0.4	0.001-0.012	–	–	0.001-0.6	0.005-0.35	0.005-0.07
Ag	–	–	–	–	0.001-0.14	0.006-0.13	–
Co	0.004-0.1	–	–	–	0.001-0.1	–	–
Al	0.001-6.7	–	3.0-12.9	0.02-0.2	0.01-0.1	–	–
S	0.001-0.15	0.004-0.06	–	–	0.001-0.14	0.001-0.05	–
Cu	REF	REF	REF	REF	REF	REF	REF

X-RAY FLUORESCENCE SPECTROMETER/PLATING THICKNESS INSTRUMENT (ADVANCED TYPE) CODE XRF-PT230



MANUAL ZOOM

- Application fields: electroplating coating thickness analysis, inspection of electronic components such as connectors, fastener industry, automotive parts, hardware industry (household equipment and accessories, such as Cr/Ni/CuZn(ABS)), new energy industry (photovoltaic welding wire, etc.), thickness analysis of accessories, Ni/Cu/Ni/FendB on rubidium iron boron magnets, metal cation detection in electroplating solution, etc.
- It can detect 90 coating elements and analyze 77 elements in alloys
- Equipped with a micro-focus X-ray generator and an advanced light path conversion focusing system, the minimum measurable area is up to 0.03mm²
- It has non-destructive manual zoom detection technology, which can perform non-destructive testing on various shaped and irregular grooved parts from 0 to 30mm
- Equipped with Si-Pin semiconductor detector, high resolution, fast testing speed, stable data, equipped with micro-light focusing technology, ranging spot diffusion less than 10%
- The core EFP algorithm allows for the simultaneous analysis of 23 coating and 24 elements. It can quickly, accurately, and stably analyze multiple layers and multiple elements, including the same element in different layers
- User-friendly closed software, automatically identifies faults, provides calibration and operation steps, and avoids misoperations



SPECIFICATION

Coating layer analysis	elemental analysis range	Li(3)-U(92)
	detection limit	0.005μm (detection limit for different elements is different)
	analysis thickness	0.01-80μm (detection limit for different elements is different)
Composition analysis	elemental analysis range	S(16)-U(92)
	detection limit	2ppm (detection limit for different elements is different)
	content analysis range	0.1%~99% (detection limit for different elements is different)
EFP algorithm	standard configuration	
Measuring time	5~300s	
Detector	Si-Pin semiconductor detector	
X-ray source	micro-focusing X-ray tube	
Collimator	standard: Ø0.3mm (Ø0.5mm, Ø0.3mm, Ø0.2mm, 0.1×0.3mm) four collimators optional, customized acceptable	
Nearest ranging spot diffusion	<10%	
Camera	1/2.7" color CCD, zoom function	
Measuring distance	zoom lens 0~30mm	
Focus method	high-sensitivity lens, manual focus	
Max. sample height	180mm	
XY stage	manual high-precision XY stage	
Available moving range	45mm×45mm	
Operation environment	15~30°C, <70%RH	
Power supply	AC220V, 50Hz, 95W	
Dimension (L×W×H)	545×380×435mm	
Weight	41kg	

STANDARD DELIVERY

Main unit	1 pc
Computer	1 pc
Printer	1 pc
Accessory box	1 pc
Twelve element plate	1 set
Ni standard tablet	1 pc
Ag standard tablet	1 pc

OPTIONAL ACCESSORY

Electroplating solution measuring cup	XRF-PT230-MC
Solution test membrane	XRF-PT230-SF
Au standard tablet	MSS-P01
Cr standard tablet	MSS-P02
Cu standard tablet	MSS-P03
Zn standard tablet	MSS-P04

CALIBRATION CURVE CAN BE CUSTOMIZED ACCORDING TO CUSTOMER REQUIREMENTS



X-RAY FLUORESCENCE SPECTROMETER (RoHS DETECTOR/ALLOY ANALYZER /PLATING THICKNESS INSTRUMENT) CODE XRF-B210

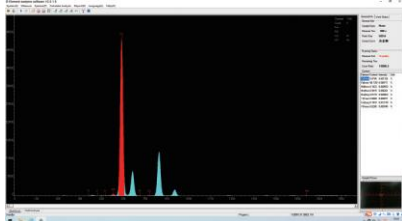

alloy composition analysis software (included)

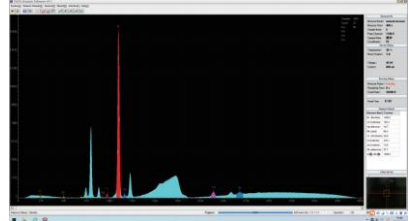

RoHS test software (included)



plating thickness detection software (included)

30

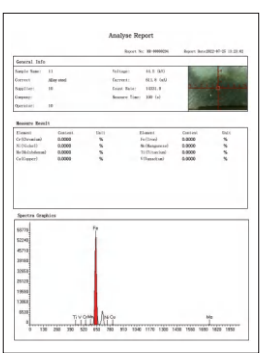

alloy composition analysis report (included)

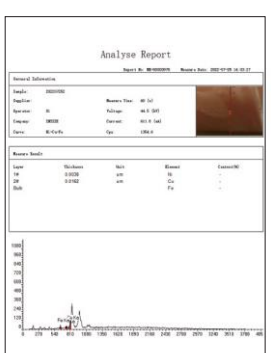

plating thickness test report (included)

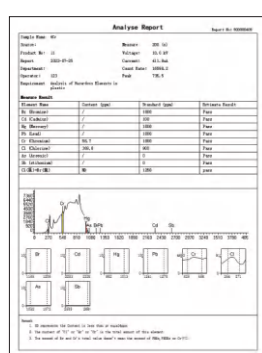

RoHS test report (included)

- Used for RoHS detection, alloy element analysis, coating thickness measurement
- Using SI-PIN detector with electric cooling, small size, accurate data analysis and low maintenance cost
- Seven optical path correction and collimation system, automatically switch according to different samples
- Multiple radiation leakage prevention design
- The temperature monitoring technology ensures the safe and reliable operation of the X-ray source
- Dedicated software, standard window design, friendly interface, easy to operate
- Can display multiple spectrograms at the same time and print multiple report forms
- USB3.0 interface to ensure accurate, high-speed and efficient data transmission

To be continued

Continued from previous page

SPECIFICATION

Detector	type	Si-PIN electrical refrigeration semiconductor detector	
	resolution	149±5eV	
	amplifier circuit module	detect the sample characteristic X-ray, further enlarge the information collected by detection	
X ray excitation device	maximum output current	1mA	
	power	50W, air cooling	
High and low voltage power	maximum output voltage	50kV, built-in voltage overload protection	
	minimum output voltage	5kV	
Multi-channel pulse amplitude analyzer		maximum channel number: 4096	
Optical path filter module		reduce interference light path in the process of sending x-rays, guarantee the accuracy of the detector signal integrate the collimator with the filter	
Collimator automatic switching module		7 kinds, Ø0.5~Ø8mm	
Filter automatic switching module		5 kinds (free to choose and switch)	
RoHS analysis software	elemental analysis range	S-U	
	harmful element analysis	Cd, Pb, Hg, Br, Cr, Cl, As, Sb	
	test time	60~200s	
	detection limit	2PPM	
	content analysis range	2PPM~99.9%	
Alloy analysis software	elemental analysis range	Ti-U	
	detection limit	100PPM	
	content analysis range	100PPM~99.9%	
	repeatability	0.1%	
	stability	0.1%	
Metal coating analysis software	elemental analysis range	Ti-U	
	detection limit	0.01µm	
	analysis thickness	single layer thickness	0.01~30µm
		3 layer thickness	≤10µm
	repeatability	0.1µm (for outside coating less than 1µm)	
	stability	0.1µm (for outside coating less than 1µm)	
light spot	within 0.2mm		
Operation temperature		10~30°C	
Relative humidity		10%~90%	
Power supply		AC 220V±5V	
Dimension (L×W×H)		700×460×370mm	
Weight		49kg	

STANDARD DELIVERY

Main unit	1 pc
Standard sample	1 pc
Silver calibration	1 pc
Sample cup	2 pcs
Test film	50 pcs
Computer	1 pc
Printer	1 pc
Collimator (built-in)	7 pcs
Software	RoHS test software, alloy composition analysis software, plating thickness detection software

CAN BE CUSTOMIZED

STANDARD SHEETS FOR XRF PLATING THICKNESS INSTRUMENTS

**INSPECTION
CERTIFICATE**



MSS-P01



MSS-P08



MSS-P14

- Can be used for standardised calibration of XRF plating thickness instruments
- Can be used to create plating measurement curves of XRF plating thickness instruments
- Supplied with manufacturer inspection certificate

STANDARD SHEETS (WITHOUT SUBSTRATE)

Code	Material	Thickness*
MSS-P01	Au	0.04-6µm
MSS-P02	Ni	0.1-20µm
MSS-PO3	Cu	1-18µm
MSS-P04	Zn	1-18µm
MSS-PO5	Al	10-75µm
MSS-P06	Cr	0.05-7.5µm
MSS-P07	Ag	0.2-20µm

* The thickness of the product is shown in the inspection certificate

SINGLE PLATING STANDARD SHEETS (WITH SUBSTRATE)

Code	Plating/Substrate	Plating thickness**
MSS-P08	Ni/Fe	2-18µm
MSS-P09	Cu/Fe	1-6.5µm
MSS-P10	Cu/Zn	12-24µm
MSS-P11	Ni/Cu	2-11µm
MSS-P12	Zn/Fe	1-40µm

MULTI-PLATING STANDARD SHEETS (WITH SUBSTRATE)

Code	Plating/Plating/Substrate	Plating thickness**
MSS-P13	Cu/Ni/Fe	3-8µm/2-6µm
MSS-P14	Sn/Ni/Cu	2-10µm/0.8-4µm
MSS-P15	Sn/Cu/Fe	2-6.5µm/0.6-4.5µm
MSS-P16	Sn/Ni/Al	4-6µm/0.1-10µm
MSS-P17	Sn/Ni/Fe	4-11µm/0.1-10µm

** The plating thickness of the product is shown in the inspection certificate

STANDARD SAMPLES FOR SPECTRAL ANALYSIS

CAN BE CUSTOMIZED



MSS-FE01



MSS-AL01



MSS-CU01

- Can be used for calibration and quality control of spectrograph measurement curves
- Can be customized based on the required range of element content
- Supplied with manufacturer inspection certificate

IRON-BASED STANDARD

(ELEMENTAL CONTENT* : %)

Alloy type	Carbon steel	Low alloy steel	Medium alloy steel	Stainless steel	High Cr cast iron	Cast iron	Pig iron
Code	MSS-FE01	MSS-FE02	MSS-FE03	MSS-FE04	MSS-FE05	MSS-FE06	MSS-FE07
C	0.066	0.436	0.322	0.044	1.63	3.59	0.0025
Si	0.136	0.208	0.613	0.392	1.76	3.01	0.021
Mn	0.464	0.495	0.83	1.24	0.722	0.622	0.143
P	0.032	0.016	0.018	0.032	0.041	0.075	0.0084
S	0.017	0.026	0.017	0.0018	0.076	0.0094	0.006
Cr	0.013	1.51	8.63	18.15	33.9	0.213	0.019
Ni	0.0075	0.127	0.148	8.21	0.366	0.204	0.009
Mo	–	0.182	0.016	0.043	0.332	–	0.002
V	–	0.0037	0.014	0.122	0.417	0.102	0.001
Als	–	1.06	0.023	0.014	–	–	–
Alt	–	1.1	0.027	0.016	–	–	–
Cu	0.001	0.096	0.47	0.197	0.223	0.246	0.0041
Co	–	0.0085	0.019	0.222	–	–	0.0016
W	–	0.0026	0.004	0.0091	–	–	0.0019
Ti	–	0.0023	0.076	0.0023	0.055	0.036	0.0005
As	–	–	0.0054	–	–	0.0025	0.0024
B	–	–	0.0002	–	–	–	0.001
Sn	–	–	0.0037	–	–	–	–
Sb	0.0013	–	0.0018	–	–	–	–
Zn	–	–	0.0034	–	–	–	–
Nb	–	–	–	0.002	0.161	–	0.001

ALUMINUM-BASED STANDARD

(ELEMENTAL CONTENT* : %)

Alloy type	Pure aluminum	Al-Cu alloy	Al-Mn alloy	Al-Si alloy	Al-Mg alloy	Al-Mg-Si alloy	Al-Zn-Mg-Cu alloy
Code	MSS-AL01	MSS-AL02	MSS-AL03	MSS-AL04	MSS-AL05	MSS-AL06	MSS-AL07
Si	0.09	0.036	0.224	7.29	0.102	1.09	0.03
Fe	0.119	0.052	0.395	0.123	0.282	0.206	0.068
Cu	0.0029	4.2	0.19	0.039	0.052	0.045	1.62
Mn	0.0023	0.589	1.04	0.045	0.371	0.775	0.034
Mg	0.012	1.34	1.16	0.414	4.68	1.07	1.39
Cr	–	0.034	–	0.039	0.041	0.114	–
Ni	–	0.032	0.044	0.035	0.028	0.055	0.031
Zn	0.0063	0.115	0.106	0.041	0.142	0.123	7.26
Ti	0.0044	0.086	0.036	0.147	0.019	0.05	0.035
Zr	–	–	–	–	–	–	0.117
Pb	0.0013	–	–	0.039	–	–	–

To be continued

Continued from previous page

COPPER-BASED STANDARD

(ELEMENTAL CONTENT*: %)

Alloy type	Pure copper	Brass	Beryllium bronze	Cu-Sn alloy	Cu-Zn-Si alloy	Cu-Al alloy
Code	MSS-CU01	MSS-CU02	MSS-CU03	MSS-CU04	MSS-CU05	MSS-CU06
Cu	99.97	61.88	97.27	92.69	80.34	81.47
Pb	0.0002	0.108	0.012	0.01	0.0005	0.0003
Zn	0.0002	37.53	0.034	0.44	15.94	0.014
P	0.00003	0.039	0.013	0.109	0.005	0.0014
Fe	0.0009	0.116	0.096	0.071	0.022	3.82
Sn	0.0002	0.0051	0.059	6.00	0.0011	0.0012
Sb	0.00002	0.0046	—	0.0016	0.0002	0.0002
As	0.00011	0.0038	—	—	0.00014	0.0003
Ni	0.00016	0.0032	0.108	0.475	0.0011	4.48
Si	0.0002	0.0029	0.086	0.0008	3.56	0.081
Bi	0.00004	0.0028	—	0.0009	0.0003	—
S	0.0013	—	—	0.0065	—	0.0009
Al	0.0003	—	0.071	0.0001	0.001	9.82
Ag	—	—	—	0.0073	0.001	0.067
Be	—	—	1.94	—	—	—
Mn	—	—	0.003	—	0.0005	—
Co	—	—	0.292	—	0.0003	—
Cd	—	—	—	—	0.0001	—

*The actual value of the content may be slightly different when delivered, it is detailed in the inspection certificate



aluminum oxide sanding disc (included)



silicon carbide sanding disc (included)

- Widely used for making specimens for spectral analysis and grinding of metal, ceramic, glass and other devices
- Compact machine structure, single disc with two speeds, can be equipped with different grits and hardnesses of grinding wheels for grinding
- The machine has smooth rotation, low noise, convenient operation and high working efficiency, and is suitable for factories and laboratories of scientific research units

SPECIFICATION

Disc diameter	350mm
Rotation speed	level 1: 1400r/min, level 2: 2800r/min (two fixed speed)
Power supply	AC380V, 50Hz, 2kW
Dimensions (L×W×H)	480×450×900mm
Weight	77kg

STANDARD DELIVERY

Main unit	1 set
Silicon carbide sanding disc	1 pc (60mesh)
Aluminum oxide sanding disc	1 pc (30mesh)

OPTIONAL ACCESSORY

Code	Material	Application	Granularity (mesh)	Diameter	Package (pcs/box)
OES-SCG60	silicon carbide	cast iron and non-ferrous metals	60	350mm	25
OES-ALG30	aluminium oxide	ferrous metals (non-cast iron)	30	350mm	30

**SPECTRAL SAMPLE GRINDER
CODE OES-MY100**



VIDEO



FOURIER TRANSFORM INFRARED SPECTROMETER CODE FTI-A170

NO SAMPLE PREPARATION REQUIRED



ZnSe crystals ATR attachment
(included)

- Widely used in medicine, chemical industry, petroleum, environmental protection, food industry, materials, public security, national defense, semiconductor, optical and other fields
- Qualitative identification of human and veterinary drugs, polymer materials, adhesives and binders, rubber, polyurethane, acrylic resins, concrete admixtures and so on
- Quantitative testing of mineral insulating oils, structural groups in lubricating oils, trans fatty acids in food and grease, atypical additives in petrol, petroleum hydrocarbons in solid waste, oils in water, etc.
- Versatile accessory options, easy replacement and installation, large sample compartment for easy expansion of other infrared accessories, such as ATR accessories, liquid test set, etc.
- With over 200,000 standard infrared spectra

SPECIFICATION

Spectral range	7800~350cm ⁻¹
Resolution	better than 1.0cm ⁻¹
Signal-to-noise ratio	better than 30000:1
Detector	infrared detector
Beam splitter	multi-coated potassium bromide, with humidity resistant coating
Scanning speed	microcomputer control and selection of different scanning speeds, gear continuously adjustable
Source of infrared light	long-life, high-intensity air-cooled infrared light source
Wavenumber precise	0.01cm ⁻¹
Software function	<ol style="list-style-type: none"> with spectrum annotation function with spectrum search and comparison function spectrogram self-addition function, spectrogram matching analysis function with tools for peak labeling/differential spectra (quadratic operation of spectra)/smoothing, etc. with peak height/peak area measurement tools export report provide at least 200,000 infrared spectra of commonly used compounds
Working environment	20%~50%RH
Weight	14kg
Dimension (L×W×H)	450×350×210mm
Power supply	AC220V, 50Hz

STANDARD DELIVERY

Main unit	1 pc
Computer	1 pc
Software	1 pc
ZnSe crystals ATR attachment	1 pc

OPTIONAL ACCESSORY

Diamond crystal ATR attachment	FTI-A170-ATRND
Solid powder tablet press machine	FTI-A170-TPM-1
Tablet press moulds	FTI-A170-TPM-2
KBr (SP grade)	FTI-A170-KBR-1
KBr mortar	FTI-A170-KBR-2
Removable liquid test set	FTI-A170-FLU
Electronic moisture-proof box	FTI-A170-MPB



removable liquid test set
(optional)



electronic moisture-proof box
(optional)

CAN BE CUSTOMIZED FOR HIGH SULPHUR CHANNEL
ACCORDING TO REQUIREMENTS

CARBON AND SULFUR ANALYZER CODE CSA-R300



- Widely used in iron and steel metallurgy, powder metallurgy, magnetic materials, new energy, third-party testing, research institutes, etc.
- Analysis of carbon and sulfur in steel, cast iron, alloys, cement, sand, glass, lime, rubber, catalysts, soil, semiconductors, electronic materials, metal ores, ceramics and other solid materials
- Adoption of high-end infrared detection system and the core components of the air circuit system ensures the stability and accuracy of detection
- The high-frequency heating system adopts special high-frequency capacitors to ensure the long-term reliability of high-frequency work
- Adopt German imported special external metal dust filter, easy to dismantle, easy to clean
- Electronic balance for accurate weighing, auto-matic tare of crucible mass, auto-matic input of sample weight
- The software can monitor solenoid status, signal acquisition status, high frequency status, baseline status, etc.
- With data management and storage, query and statistics, printing projects, generating reports



SPECIFICATION

Detector	pyroelectric solid state infrared detectors
Light source	infrared light source
Channel configuration	standard with high carbon, low carbon, low sulfur
Thermostatic	gas chamber thermostat control
Analysis range	low carbon: 0.6ppm~0.1%, high carbon: 0.1%~50%, low sulfur: 0.6ppm~0.3%*
Analysis accuracy	carbon: 1ppm or RSD≤0.5%, Sulfur: 1ppm or RSD≤1.0%
Sensitivity	0.01ppm
Analysis time	30s~40s
Sample weighing	recommended range 0.1g~0.5g, can be changed according to the sample content
Combustion furnace	18MHz, 2.7KVA
Carrier gas	oxygen concentration ≥99.5%
Motive gas	nitrogen concentration ≥99.5%
Power supply	AC220V±10%, 50Hz, 16A
Dimensions (L×W×H)	545×380×435mm
Weight	70kg

* Changing the weighing volume can extend the analysis range up to 100%, can be customized for high sulfur channel with 0.3-30% analysis range

STANDARD DELIVERY

Main unit	1 pc
Computer	1 pc
Software	1 pc
Dust catcher	1 pc
Electronic balance	1 pc
Printer	1 pc
Pressure valve	1 pc
Standard sample	3 pcs
Soda lime (CSA-R300-SL)	1 pc
Tungsten flux (CSA-R300-TF)	1 pc
Desiccant (CSA-R300-DE)	1 pc
Crucible (CSA-R300-CR)	1000 pcs
Toolkit*	1 set

* Including allen wrench, crucible tweezer, tungsten grain spoon, sample spoon, cotton wool and vacuum silicone grease, etc.

GAS CHROMATOGRAPHY (RoHS2.0 O-BENZENE FAST SIFTER) CODE GCT-2400



STANDARD DELIVERY

Main unit	1 pc
Computer	1 pc
Thermal cracker	1 pc
Software	1 pc
Standard sample	2 pcs
Air generator	1 set
Hydrogen generator	1 set
Consumable and spare parts	1 set*

* Including injection needles, injection pads, graphite pads, gas connection lines and other common consumables and tools



thermal cracker
(included)

- Easy to operate and requires just 20 minutes for sample analysis
- No need to handle samples during use, no chemical reagents are used, and no waste liquid or gas is generated
- The instrument adopts a microcomputer system to control temperature with high precision, high reliability, and anti-interference
- The instrument has a network remote control function with ethernet communication interface to analyze the data

30

SPECIFICATION

Analysis material	Di (2-ethylhexyl) phthalate (DEHP), Benzyl butyl phthalate (DBP), Dibutyl phthalate (BBP), Diisobutyl phthalate (DIBP)
Temperature control area	8 signals
Temperature control range	above room temperature 4-450°C, incremental 1°C, accurate: ±0.1°C
Program temperature rise step	20th step
Program temperature rise rate	0.1-60°C/min
Measurement range	0-0.25Mpa (pressure), 0-1000ml/min (flow rate)
Injection valve	automation
Sampler type	capillary injection
Capillary column	Ø0.53mm×30m×0.50µm (shunt)
Detector	hydrogen flame ionization detector (FID)
Detection limit	≤3×10 ⁻¹² g/S (n-hexadecane)
Baseline noise	≤1×10 ⁻¹⁴ A (after 2 hours of instrument stabilization)
Baseline drift	≤1×10 ⁻¹³ A/30min (after 2 hours of instrument stabilization)
Linear range	≥10 ⁶
Carrier gas	N ₂ ≥99.9995%
Natural gas	H ₂ ≥99.9995%
Combustion gas	dry oil-free air
Data processing	1. can simultaneously process data from up to 5000 chromatographs 2. can automatically generate chromatograph files 3. can name chromatograph folders by time and shift sequence
Communication interface	ethernet: IEEE802.3
Working environment	5~35°C, 0~85%RH
Power supply	AC220V±10%, 50Hz (±0.5Hz), 3kW
Dimension (L×W×H)	600×560×500mm
Weight	55kg



hydrogen generator
(included)



air generator
(included)

OPTIONAL ACCESSORY

Electronic balance	8304-120	maximum weighing capacity 120g, resolution 0.1mg
	8304-220	maximum weighing capacity 220g, resolution 0.1mg
Capillary column	GCT-2400-CC	Ø0.53mm×30m×0.50µm
Standard sample	GCT-2400-BY	mixed standard of 4 phthalates (1000µg/mL)



ANALYSIS METHODS AND CONFIGURATIONS CAN BE CUSTOMIZED ACCORDING TO INSPECTION REQUIREMENTS

GAS CHROMATOGRAPHY (ADVANCED TYPE) CODE GCT-3600

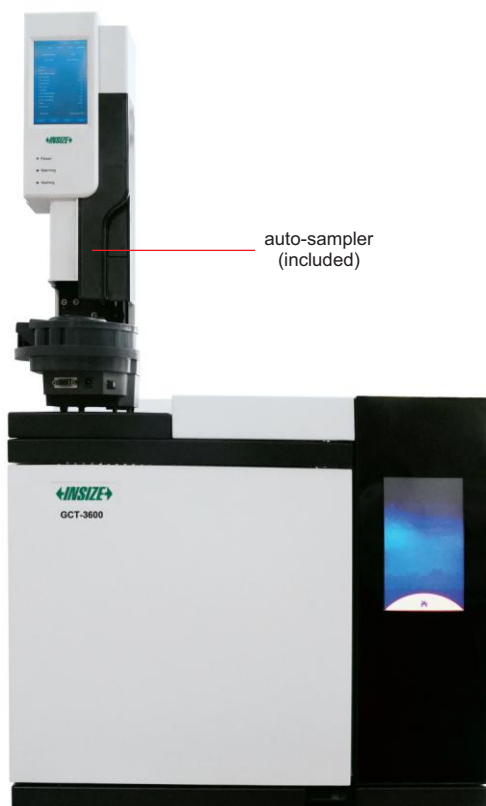

hydrogen generator
(included)



air generator
(included)



electronic balance
(optional)

DETECTORS

Thermal conductivity detector (TCD)	code	GCT-D-TCD
	sensitivity	$\geq 10000 \text{mv} \cdot \text{mL/mg}$ (Benzene/Toluene)
	baseline noise	$\leq 20 \mu\text{v}$
	baseline drift	$\leq 20 \mu\text{v}/30 \text{min}$
	TC bridge road	air break protection: protects the tungsten filament from damage
	analysis material	purity of industrial gases such as oxygen, nitrogen, helium, etc. and VOCs
Flame photometric detector (FPD)	code	GCT-D-FPD
	detection limit	(S) $\leq 5 \times 10^{-11} \text{g/s}$ (Thiophene/Ethanol), (P) $\leq 1 \times 10^{-12} \text{g/s}$ (Methyl Parathion/Ethanol)
	baseline noise	$\leq 3 \times 10^{-13} \text{A}$
	baseline drift	$\leq 2 \times 10^{-12} \text{A}/30 \text{min}$
	linear range	$S \geq 10^2, P \geq 10^3$
analysis material	sulfur and phosphorus containing compounds	
Electron capture detector (ECD)	code	GCT-D-ECD
	detection limit	$\leq 1 \times 10^{-14} \text{g/mL}$ (Propyl Hexahydroxy/Isooctane)
	baseline noise	$\leq 0.03 \text{mV}$
	baseline drift	$\leq 0.2 \text{mV}/30 \text{min}$
	radiation source	Ni^{63}
analysis material	halogenated compounds, peroxides, nitro compounds, metal-organic compounds, steroidal compounds, polycyclic aromatic compounds, etc.	
Nitrogen phosphorus detector (NPD)	code	GCT-D-NPD
	detection limit	(P) $\leq 5 \times 10^{-13} \text{g/s}$ (Malathion/Isooctane), (N) $\leq 7 \times 10^{-13} \text{g/s}$ (Azobenzene/Isooctane)
	baseline noise	$\leq 3 \times 10^{-13} \text{A}$
	baseline drift	$\leq 2 \times 10^{-12} \text{A}/30 \text{min}$
	linear range	$\geq 10^3$
analysis material	organic compounds containing nitrogen and phosphorus	

To be continued

Continued from previous page

- Widely used in petrochemical, environmental analysis, food analysis, drug analysis, polymer analysis, etc.
- The instrument is equipped with a 7" screen, supports hot-swappable, can be used as a handheld controller
- The instrument adopts a microcomputer system to control temperature with high precision, high reliability, and anti-interference
- The instrument is equipped with an electronic flow control unit (EFC) and an electronic pressure control unit (EPC) to improve stability and repeatability
- Chromatography microcomputer system with MODBUS/TCP standard protocol, can be interfaced with DCS system

SPECIFICATION

Analysis material		hydrocarbons, carbonaceous organic matter (COC), volatile organic compound (VOCs), etc.
Control system	temperature control area	8 signals
	temperature control range	above room temperature 4-450°C, incremental 1°C, accurate: ±0.1°C
	program temperature rise rate	0.1-120°C/min
	air circuit control	full electronic pressure flow control
	measurement range	0-100Psi (pressure), 0-1000mL/min (flow rate)
	resolution	0-0.1Psi (pressure), 0-1mL/min (flow rate)
	external control	8 signals, auxiliary control output 2 signals
Detector	program temperature rise step	16 steps
	type	hydrogen flame ionization detector (FID)
	detection limit	≤3×10 ⁻¹² g/S (n-hexadecane)
	baseline noise	≤1×10 ⁻¹⁴ A (after 2 hours of instrument stabilization)
Auto-sampler	baseline drift	≤1×10 ⁻¹³ A/30min (after 2 hours of instrument stabilization)
	syringe specifications	1, 5, 10, 25, 50, 100, 250, 500 (μL)
	vial position	24 bits (customizable expansion to 160 bits)
	solvent bottle position	2 bits (customizable expansion to 11 bits)
	vial volume	2mL
	injection volume	0.1-250μL
	feed rate	fast, slow, user-defined
Gas supply	feed mode	general, continuous, PTV, user-defined
	carrier gas	N ₂ ≥99.999%
	natural gas	H ₂ ≥99.999%
Data processing	combustion gas	dry oil-free air
	1. can simultaneously process data from up to 5000 chromatographies 2. can automatically generate chromatography files 3. can name chromatography folders by time and shift sequence	
	Communication interface	ethernet: IEEE802.3
Working environment	15~30°C, ≤85%RH	
Power supply	AC 220V, 50Hz, 3kW	
Dimension (L×W×H)	560×530×480mm	
Weight	60kg	

STANDARD DELIVERY

Main unit	1 pc
Auto-sampler	1 pc
Computer	1 pc
Software	1 pc
Detector (FID)	1 pc
Hydrogen generator	1 pc
Air generator	1 pc
Gas purifier	1 pc
Column(SE-54)	1 pc
Consumable and spare parts	1 set*

* Including injection needles, injection pads, graphite pads, gas connection lines and other common consumables and tools

OPTIONAL ACCESSORY

Electronic balance	8304-220
Thermal conductivity detector**	GCT-D-TCD
Flame photometric detector**	GCT-D-FPD
Electron capture detector**	GCT-D-ECD
Nitrogen phosphorus detector**	GCT-D-NPD

** The detector needs to be ordered with the main unit together, up to two detectors can be ordered



ANALYSIS METHODS AND CONFIGURATIONS CAN BE CUSTOMIZED ACCORDING TO INSPECTION REQUIREMENTS

LIQUID CHROMATOGRAPHY CODE HLC-3000

- Ultraviolet-Visible detector (included)

 - Highly accurate, self-calibrating analog-to-digital converter and optical path system improves the signal-to-noise ratio of the detector
 - With automatic wavelength calibration and the ability to optimize the deuterium lamp energy
 - Digital and analog signal output at the same time, more practical
 - Dual wavelength simultaneous detection for more accurate results

- Auto-sampler (included)

 - The patented inlet design and unique cleaning method ensure ultra-low sample residue
 - The cooling function of the sample tray makes the sample analysis process more stable
 - Support high-speed sampling mode, the fastest can be realized within 1s

- High pressure pump (included)

 - Patented low-pulsation, high-precision, tandem, dual-plunger, high-pressure, constant-current pump designed to minimize pulsation
 - The special seal design makes the maximum pressure resistance of the pump up to 90 MPa, which meets the requirements of many kinds of analytical experiments
 - Multi-stage microporous mixing with labyrinth design mixer for more uniform mixing and lower pulsation



column oven (included)



evaporative light-scattering detector (optional)



fluorescence detector (optional)



photo-diode array detector (optional)



refractive index detector (optional)

- Widely used in drug discovery, food safety, environmental testing, life sciences, etc.
- Various temperature control modes of the column temperature chamber make the temperature more accurate
- The auto-sampler has a high-speed injection mode that makes the analysis process faster
- The cooling function ensures the stability of the analysis process even for biological samples
- EMC electromagnetic compatibility function can avoid other electromagnetic interference, and makes the instrument more stable

To be continued

Continued from previous page

SPECIFICATION

Detector	analysis material	organic compounds, inorganic ions, biomolecules (such as DNA, proteins) with UV-visible absorption properties
	type	Ultraviolet-Visible detector
	wavelength range	190~800nm
	baseline noise	$\leq 1.5 \times 10^{-5}$ AU
	baseline drift	$\leq 2.0 \times 10^{-4}$ AU/h
	light source	deuterium lamp, tungsten lamp
	bandwidth	8nm
	minimum detection concentration	$\leq 1.0 \times 10^{-9}$ g/mL
	linear range	≥ 2.5 AU
	wavelength accuracy	± 1 nm
	wavelength repeatability	$\leq \pm 0.2$ nm
	detection cell temperature control	5-55°C, setting step 0.1°C
	detection cell optical range	10nm
detection cell pressure	≤ 0.1 Mpa	
High pressure pump	pump type	binary high pressure constant current pump
	gradient mixing accuracy	$\pm 0.5\%$
	gradient mixing precision	$\leq 0.1\%$
	flow range	0.001~10.000mL/min
	maximum working pressure	90Mpa
	flow stability	$\leq 0.06\%$
	gradient composition ratio	0~100%, programmable range
	pressure pulsation	≤ 0.1 Mpa
Auto-sampler	temperature control range	4~40°C
	special function	empty bottle detection and false tie alarm
	injection method	full loop injection, lossy injection, lossless injection
	input range	0~100 μ L
	vial quantity and specification	210th (1mL vial) 120th (2mL vial) 72th (4mL vial) double 96-well plate (support base magnetic plate option)
	input residue	$< 0.002\%$
	sample repeatability	$< 0.03\%$
feed rate	support high-speed sampling mode, the fastest can realize 1s sampling	
Column oven	temperature range	heating mode: 10~85°C cooling mode: 4~35°C smart mode: 4~85°C
	heating method	pall paste element plus air circulation for temperature control
	temperature accuracy	$\pm 0.1^\circ\text{C}$
	optional valves	optional 2 six-position seven-way valves or 2-position 6-way valve or 2-position 10-way valve
temperature control accuracy	$\leq 0.1^\circ\text{C}$	
Power supply	110~220V, 50/60Hz, 1400W	
Dimensions (L×W×H)	600×540×540mm	
Weight	75kg	

STANDARD DELIVERY

High pressure pump	1 pc
Auto-sampler	1 pc
Column oven	1 pc
Ultraviolet-Visible detector	1 pc
Solvent bottle tray	1 pc
Sample cell	1 pc
Chromatography data workstation	1 set
Column (5 μ m 4.6×250mm)	1 pc
Mobile phase solvent bottles	2 pcs
Computer	1 pc
Consumables and spare parts	1 set*

* Including common consumable tools such as connecting pipes and pipe joints

To be continued

Continued from previous page

OPTIONAL ACCESSORY

Name	Code	Analysis material
Evaporative light-scattering detector (ELSD)	HLC-D-ELSD	sugars, alcohols, amino acids, etc.
Fluorescence detector (FLD)	HLC-D-FLD	analysis of compounds with fluorescent properties, such as pesticide residues, veterinary drug residues, certain biomolecules, etc.
Photo-diode array detector (PDA)	HLC-D-PDA	proteins, nucleic acids and other biomolecules
Refractive index detector (RID)	HLC-D-RID	sugars, polymers, etc.

SOFTWARE (INCLUDED)

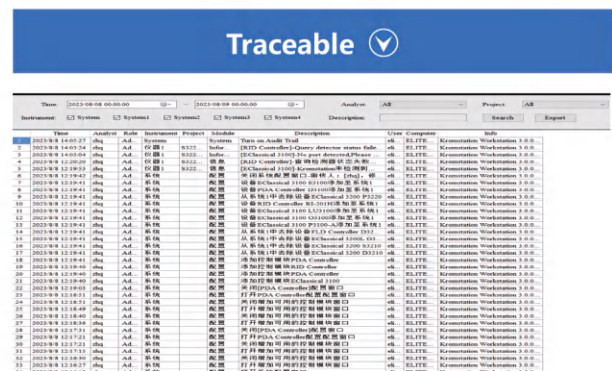
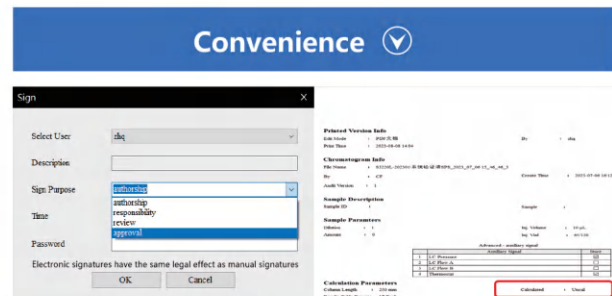
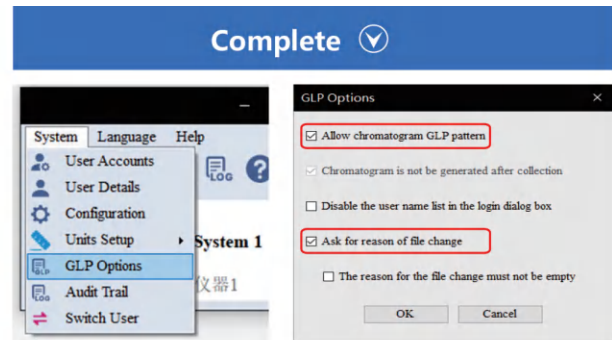
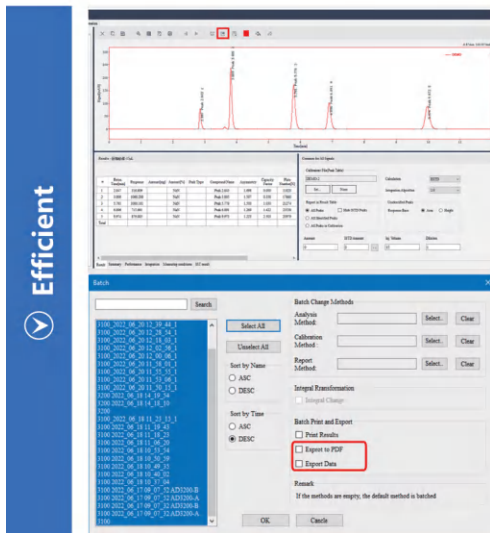
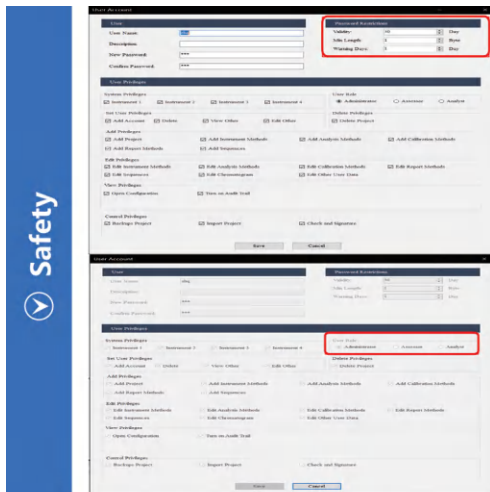



Universal Testing Machines
Page 947-955



High And Low Temperature Test Chambers For Electronic Universal Testing Machines
Page 949



Extensometers
Page 955



Video Extensometers
Page 956-957

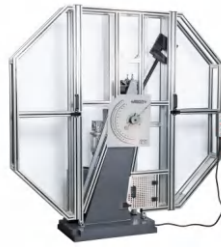

Impact Testing Machines
Page 960-963



Impact Standard Samples
Page 964



Impact Specimen Notch Broaching Machines
Page 965



Impact Broaches
Page 965



Friction And Wear Testing Machines
Page 966



Friction/Peel Testers
Page 967



Pneumatic Key Life Testers
Page 968



Tensile And Compression Testing Machines
Page 969

TESTING MACHINES, FORCE GAUGES, TENSION METERS



Digital Spring Testers
Page 970



Force Gauges
Page 971-974/979



Test Stands For Force Gauges
Page 973-978



Tensile/Compression Sensors
Page 980



Tube Force Gauges
Page 981



Dial Tension Gauges
Page 981



Wire Tension Meters
Page 982



Belt Tension Meters
Page 983



Spindle Tension Meters
Page 984-985

ELECTRONIC UNIVERSAL TESTING MACHINES



computer and software (included)

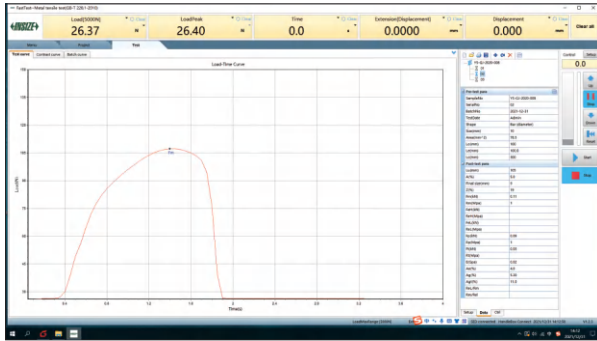

flat jaws (included)



V-shaped jaws (included)



UTM-E50

- For testing and researching the mechanical properties of metals, ceramics, plastics, rubber and composite materials
- For research and quality control of mechanical properties of materials for a wide range of products such as mechanical components, electronic components, food packaging materials, chemical fibres, films and new energy batteries

SPECIFICATION

Code	UTM-E10	UTM-E20	UTM-E30	UTM-E50
Max. test force	10kN	20kN	30kN	50kN
Accuracy class	class 0.5			
Accuracy of test force	±0.5% of indicated value			
Range of test force	0.2%~100%FS			
Resolution of test force	1/500000FS			
Crossbeam displacement accuracy	±0.5% of indicated value			
Crossbeam displacement resolution	0.025µm			
Range of speed adjustment	0.001~500mm/min			
Accuracy of crossbeam speed	±1% of the set value (speed<0.5mm/min) ±0.1% of the set value (speed≥0.5mm/min)			
Range of force control speed	0.005~5%FS/s			
Accuracy of crossbeam speed	±1% of the set value (speed<0.05%FS/s) ±0.5% of the set value (speed≥0.05%FS/s)			
Compression fixture	Ø100mm	Ø100mm	Ø100mm	Ø100mm
Wedge tension fixture	flat jaw: 0~7mm	flat jaw: 0~7mm V-jaw: Ø4~Ø9mm	flat jaw: 0~7mm V-jaw: Ø4~Ø9mm	flat jaw: 0~14mm V-jaw: Ø4~Ø14mm
Effective test width *	400mm	440mm	440mm	440mm
Vertical test space *	1030mm	970mm	970mm	970mm
Effective compression height *	800mm	700mm	700mm	700mm
Dimension (W×D×H)	715×500×1680mm	820×620×1880mm	820×620×1880mm	820×620×1880mm
Weight	230kg	350kg	350kg	350kg
Power supply	AC 220V, 50Hz, 0.4kW~1kW			

* Can be customized according to test requirements

To be continued

Continued from previous page

SPECIFICATION

Code	UTM-E100	UTM-E200	UTM-E300	UTM-E600
Max. test force	100kN	200kN	300kN	600kN
Accuracy class	class 0.5			
Accuracy of test force	±0.5% of indicated value			
Range of test force	0.2%~100%FS			
Resolution of test force	1/500000FS			
Crossbeam displacement accuracy	±0.5% of indicated value			
Crossbeam displacement resolution	0.025µm			
Range of speed adjustment	0.001~500mm/min			0.001~250mm/min
Accuracy of crossbeam speed	±1% of the set value (speed<0.5mm/min) ±0.1% of the set value (speed≥0.5mm/min)			
Range of force control speed	0.005~5%FS/s			
Accuracy of crossbeam speed	±1% of the set value (speed<0.05%FS/s) ±0.5% of the set value (speed≥0.05%FS/s)			
Compression fixture	Ø160mm	Ø150mm	Ø150mm	Ø200mm
Wedge tension fixture	flat jaw: 0~20mm V-jaw: Ø8~Ø26mm	flat jaw: 0~30mm V-jaw: Ø8~Ø36mm	flat jaw: 0~30mm V-jaw: Ø8~Ø36mm	flat jaw: 0~30mm V-jaw: Ø8~Ø46mm
Effective test width *	600mm	600mm	600mm	750mm
Vertical test space *	1250mm	1000mm	1000mm	1100mm
Effective compression height *	700mm	600mm	600mm	650mm
Dimension (W×D×H)	1070×855×2180mm	1070×920×2550mm	1070×920×2550mm	1140×1580×2980mm
Weight	1000kg	1500kg	1500kg	5000kg
Power supply	AC380V, 3Ø, 50Hz, 2kW~5kW			

* Can be customized according to test requirements

SPECIFICATION OF LARGE DEFORMATION EXTENSOMETER (OPTIONAL)

Code	UTM-EY1	UTM-EY2
Range of deformation	10~800mm	
Accuracy of deformation	±1%	
Resolution of deformation	0.01mm	0.004mm
Type of blade	flat blade	
Range of clamp	thicknesses<10mm, width<30mm	

STANDARD DELIVERY

Main unit	1 pc
Control box	1 pc
Measuring software	1 pc
Computer	1 pc
Printer	1 pc
Compression fixture	1 set
Wedge tension fixture	1 set

OPTIONAL ACCESSORY

Fixture	UTM-F series (customized, selection of specifications according to test requirements)
Extensometer	UTM-EX series (customizable)
Video extensometer	UTM-M series
Large deformation extensometer	UTM-EY series (customizable)
Security door	customized, available in plexiglass or wire mesh



large deformation extensometer (optional)

HIGH AND LOW TEMPERATURE TEST CHAMBERS FOR ELECTRONIC UNIVERSAL TESTING MACHINES



UTT-M63-E50

- For UTM-E□□□ electronic universal testing machines
- For tensile, compression, bend, shear tests in high and low temperature environment

SPECIFICATION

Code	for UTM-E10	UTT-M03-E10	UTT-M33-E10	UTT-M63-E10
	for UTM-E50	UTT-M03-E50	UTT-M33-E50	UTT-M63-E50
	for UTM-E100	UTT-M03-E100	UTT-M33-E100	UTT-M63-E100
Temperature range		(room temperature+10)~300°C	-30~300°C	-60~300°C
Temperature accuracy *		±1°C		
Temperature fluctuation *		±0.5°C		
Temperature uniformity *		≤2°C		
Temperature resolution		0.1°C		
Cooling system		no	compressor or liquid nitrogen	
Cooling time (room temperature@25°C)			1~2°C/min (no-load)	
Warming up time		1~3°C/min (no-load)		
Temperature control		PID automatic temperature control		
Heating system		magnesium powder heating tube		
Aperture size		Ø50mm		
Chamber dimension **		240×430×530mm (suitable for electronic universal testing machines with column spacing of 400mm and above)		
Power supply		AC 220V, 60Hz		
Total power		1.8kW	2.2kW	2.8kW

*The applicable range of temperature accuracy, uniformity and fluctuation is Ø100×200mm

** Customized according to UTM-E□□□ electronic universal testing machine and customer requirements



ELECTRONIC UNIVERSAL TESTING MACHINES (ADVANCED TYPE)



UTM-X010

wired hand control box (included)



- Equipped with a variety of test software, can be for metal, ceramics, plastics, rubber and composite materials and other related mechanical properties of the test and research
- Can be used for research and quality control of mechanical properties of various products such as mechanical parts, electronic parts, food packaging materials, chemical fibres, films, new energy batteries and so on
- The rigidity of the host, loading speed and load, deformation measurement accuracy, data reliability, adoption rate and closed-loop control rate are excellent

test interface



test and calibration interface

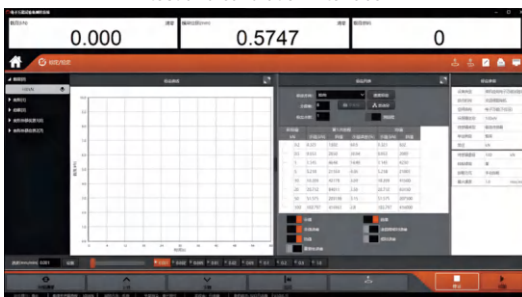

fully automatic extensometer (optional) (class 0.5 high-precision fully-automatic extensometer with a wide measuring range for automatic testing and full strain measurement)



security door (optional)



compression fixture (optional)



tensile fixture (optional)

To be continued

Continued from previous page



high and low temperature environment box (optional)



constant temperature and humidity box (optional)



high temperature furnace (optional)



high precision axial extensometer (optional) (a variety of scales can be selected to fully meet the requirements of variety of materials, the accuracy meets class 0.5)

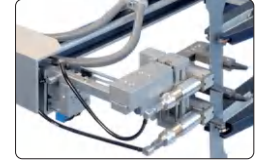

width gauge (optional) (widely used for r-value and poisson's ratio measurements, meets the requirements of ASTM E517 and ISO10113)

SPECIFICATION

Code	UTM-X001	UTM-X005	UTM-X010	UTM-X050	UTM-X100	UTM-X300	
Max. test force	1kN	5kN	10kN	50kN	100kN	300kN	
Accuracy class	class 0.5						
Accuracy of test force	±0.5% of indicated value						
Range of test force	0.2%~100%FS						
Test force resolution	0.002N	0.02N	0.02N	0.2N	0.2N	0.5N	
Crossbeam displacement accuracy	±0.1% of indicated value						
Crossbeam displacement resolution	0.1μm						
Velocity accuracy	±0.1% of indicated value						
Range of speed adjustment	0.001~1000mm/min			0.001~800mm/min		0.001~500mm/min	
Effective test width	420mm			600mm		1450mm	
Vertical test space	standard model	1200mm			1255mm		1450mm
	heightened 250mm (optional)	1450mm			1505mm		1700mm
	heightened 500mm (optional)	1700mm			—		—
Dimension (W×D×H)	standard model	748×582×1600mm			1100×724×2160mm		1180×756×2440mm
	heightened 250mm (optional)	748×582×1850mm			1100×724×2410mm		1180×756×2690mm
	heightened 500mm (optional)	748×582×2100mm			—		—
Weight	standard model	160kg			610kg		965kg
	heightened 250mm (optional)	185kg			660kg		1015kg
	heightened 500mm (optional)	210kg			—		—
Power supply	AC220V, 50Hz, 1kW			AC380V, 3Ø, 50Hz, 4kW	AC380V, 3Ø, 50Hz, 4.5kW	AC380V, 3Ø, 50Hz, 6kW	
Environment requirements	temp: 5~40°C, humidity level: 5~85%RH, non-condensing no vibration						

STANDARD DELIVERY

Main unit	1 pc
Control box	1 pc
Computer	1 pc
Software	1 pc
Printer	1 pc

OPTIONAL ACCESSORY

Security door *	customizable
Fixture *	
Extensometer *	
Width gauge *	
High temperature furnace *	
Constant temperature and humidity box *	
High and low temperature environment box *	

* Selection of specifications according to test requirements

ELECTRONIC UNIVERSAL TESTING MACHINES



computer and software (included)

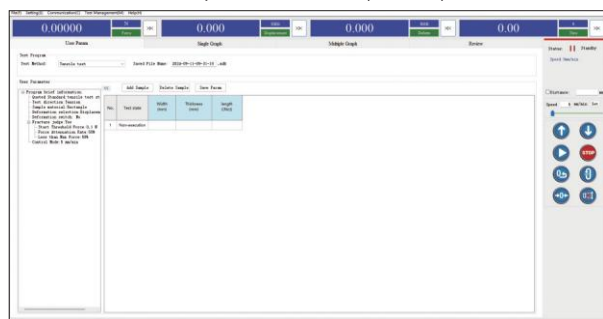

UTM-Z500

- Applicable to metal, non-metal and composite materials for tensile, compression, bending and other mechanical properties test analysis and analytical research
- Automatically obtain the maximum force, breaking force, yield strength, upper and lower yield strength, tensile strength, compressive strength, elongation at break, tensile modulus of elasticity, bending modulus of elasticity and other test data
- Test standards and test parameters can be managed and imported or exported test standards
- Overload emergency shutdown protection device, up and down travel limit protection device
- Crossbeam movement collision mitigation function

SPECIFICATION

Code	UTM-Z50	UTM-Z500	UTM-Z1000	UTM-Z2000	UTM-Z5000
Max. test force *	50N	500N	1000N	2000N	5000N
Accuracy class	class 0.5				
Range of test force	0.4%~100%FS				
Accuracy of test force	±0.5% of indicating value				
Resolution of test force	1/300000FS				
Accuracy of displacement	±0.5% of indicating value				
Resolution of displacement	0.2µm				
Range of crossbeam speed	0.001~1000mm/min				
Accuracy of crossbeam speed	±0.5% of indicating value				
Range of force control speed	0.05%~10%FS/s				
Accuracy of force control speed	±0.5% of indicating value				
Effective tensile travel *	550mm				
Effective compression travel *	700mm				
Dimension (W×D×H)	500×380×1150mm				
Power supply	AC 220V, 50Hz				
Weight	100kg				

STANDARD DELIVERY

Main unit	1 pc
Computer	1 set
Software	1 set
Control box	1 pc
Tensile fixture	1 set

OPTIONAL ACCESSORY

Fixture *	customized
Extensometer *	
Large deformation extensometer *	
Security cover *	

* Can be customized according to test requirements

ELECTRONIC UNIVERSAL TESTING MACHINES



computer and software (included)

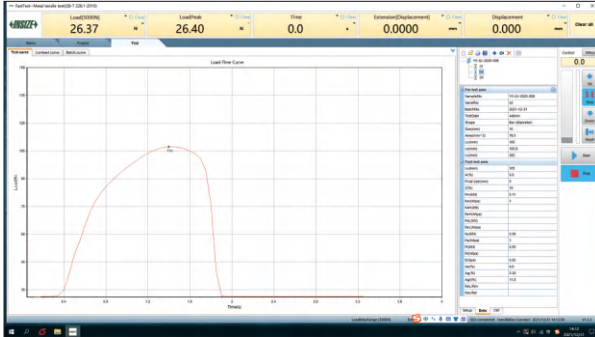

UTM-S5KA

- For testing and researching the mechanical properties of metals, ceramics, plastics, rubber and composite materials
- For research and quality control of mechanical properties of materials for a wide range of products such as mechanical components, electronic components, food packaging materials, chemical fibres, films and new energy batteries

31

SPECIFICATION

Code	UTM-S200A	UTM-S500A	UTM-S1KA	UTM-S2KA	UTM-S5KA
Max. test force	200N	500N	1kN	2kN	5kN
Accuracy class	class 0.5				
Accuracy of test force	±0.5% of indicated value				
Range of test force	0.2%~100%FS				
Resolution of test force	1/500000FS				
Crossbeam displacement accuracy	±0.5% of indicated value				
Crossbeam displacement resolution	0.025µm				
Range of speed adjustment	0.001~500mm/min				
Accuracy of crossbeam speed	±1% of the set value (speed<0.5mm/min) ±0.1% of the set value (speed≥0.5mm/min)				
Range of force control speed	0.005~5%FS/s				
Accuracy of constant load force	±1% of the set value (speed<0.05%FS/s) ±0.5% of the set value (speed≥0.05%FS/s)				
Vertical test space *	1120mm				
Effective compression height *	800mm				
Dimension (W×D×H)	510×510×1580mm				
Weight	150kg				
Power supply	AC220V, 50Hz, 0.4kW				

* Can be customized according to test requirements

STANDARD DELIVERY

Main unit	1 pc
Control box	1 pc
Measuring software	1 pc
Computer	1 pc
Printer	1 pc
Compression fixture (except UTM-S200A)	1 set
Tension fixture	1 set

OPTIONAL ACCESSORY

Fixture	UTM-F series (customized, selection of specifications according to test requirements)
Extensometer	UTM-EX series (customizable)
Video extensometer	UTM-M series
Large deformation extensometer	UTM-EY series (customizable, page 948)
Security door	customized



HYDRAULIC UNIVERSAL TESTING MACHINES

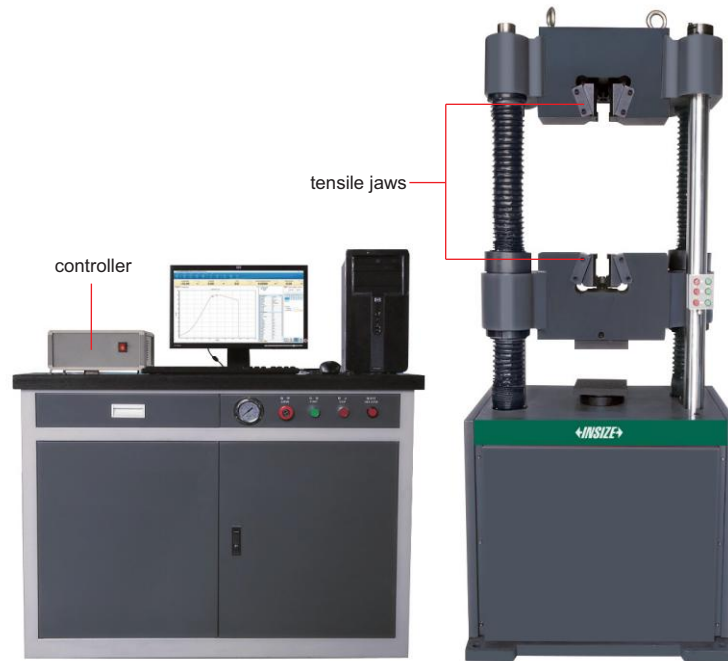

UTM-H300B

- For tensile, compression, bend, shear tests of metal and non-metal materials

SPECIFICATION

Code	UTM-H300B	UTM-H600B	UTM-H1000B	UTM-H2000B	UTM-H3000B	
Max. test force	300kN	600kN	1000kN	2000kN	3000kN	
Accuracy	±1%					
Test force measurement range	2%~100%FS					
Resolution of test force measurement	1/300000 of Max. test force (same resolution all the way)					
Deformation measurement device	extensometer					
Deformation measurement range	1%~100%FS					
Deformation measurement accuracy	±1%					
Deformation measurement resolution	1/300000					
Displacement accuracy	±1%					
Displacement resolution	0.01mm					
Displacement travel	200mm					
Max tensile space (including piston stroke)	600mm	600mm	680mm	600mm	900mm	
Max compression space (including piston stroke)	500mm	500mm	560mm	500mm	800mm	
Transmission mode	chain drive					
Safety protection device	software protection and mechanical limit protection					
Control function	special software, closed-loop of stress, strain and velocity					
Clamping range of round sample	Ø10~32mm	Ø13~40mm	Ø13~60mm	Ø20~70mm	Ø25~80mm	
Clamping range of flat sample	0~15mm	0~15mm*	0~20mm**	0~40mm	0~80mm	
Upper and lower pressure plate size	Ø188mm	Ø188mm	Ø208mm	Ø208mm	Ø208mm	
Bending branch roll width	140mm					
Total power	2.5kW	3.0kW	3.0kW	3.75kW	5.5kW	
Power supply	380V, 50Hz					
Dimension (mm)	host	800×620×1900	820×650×2000	940×780×2250	1100×760×3000	1250×930×3550
	oil source	1140×600×855				
Weight	2T	2.2T	3T	7.5T	12.6T	

*Customizable 0~30mm

**Customizable 0~40mm

To be continued

Continued from previous page

computer and software (included)

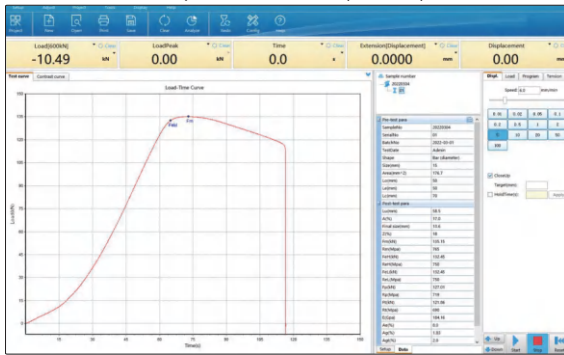

STANDARD DELIVERY

Main unit	1 pc
Electro hydraulic servo oil source	1 pc
Electro hydraulic servo valve	1 pc
High pressure oil pump	1 pc
Oil pressure sensor	1 pc
Control box	1 pc
Extensometer	1 pc
Computer	1 pc
Measuring software	1 set
Printer	1 pc
Tensile fixture	1 set
Compression fixture	1 set



acrylic safety shield (optional)



steel wire safety shield (optional)

OPTIONAL ACCESSORY

Acrylic safety shield	UTM-H-COVER1
Steel wire safety shield	UTM-H-COVER2

EXTENSOMETERS

- For universal testing machines

SPECIFICATION

Code	Gauge length	Deformation
UTM-EX25-5	25mm	5mm
UTM-EX25-10	25mm	10mm
UTM-EX25-25	25mm	25mm
UTM-EX50-5	50mm	5mm
UTM-EX50-10	50mm	10mm
UTM-EX50-25	50mm	25mm
UTM-EX100-5	100mm	5mm
UTM-EX100-10	100mm	10mm
UTM-EX100-25	100mm	25mm
UTM-EX200-5	200mm	5mm
UTM-EX200-10	200mm	10mm
UTM-EX200-25	200mm	25mm
UTM-EX-B	large deformation, customized according to the workpieces	

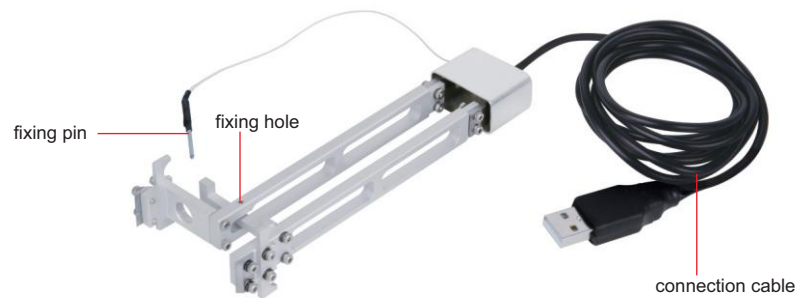

UTM-EX50-10

VIDEO EXTENSOMETERS



software (included)

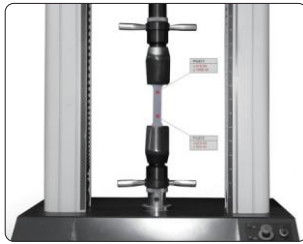

application

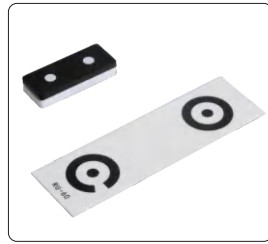

calibration card (included)



UTM-MB1

- Video extensometer is a non-contact, high-precision real-time measurement system, based on vision and image-related algorithms, which realizes real-time measurement of displacement and strain by photographing and analyzing the changes in the image characteristics of the specimen during the loading process. It has the advantages of high precision, wide measurement range, and visualization of the results
- It is used for testing and analyzing the performance of specimens in tension, compression, bending, creep, fatigue, etc. It includes strain (elongation) measurement, tensile/compressive strength measurement, modulus of elasticity measurement and Poisson's ratio measurement
- According to ISO 9513

SPECIFICATION

Code	UTM-MA1	UTM-MA2	UTM-MA3	UTM-MB1	UTM-MB2	UTM-MB3	UTM-MC1	UTM-MC2	UTM-MC3
Accuracy	±1.5μm or ±0.5% of indicated value			±1.0μm or ±0.5% of indicated value			±0.5μm or ±0.5% of indicated value		
Resolution	0.1μm								
Range of deformation	standard: 60~100mm extensions: 100~500mm (±1%)			standard: 60~150mm extensions: 150~1000mm (±1%)			standard: 60~240mm extensions: 240~1500mm (±1%)		
Range of scale	≤500mm			≤1000mm			≤1500mm		
Number of scales	≤2	≤10	≤10	≤2	≤10	≤10	≤2	≤10	≤10
Frame rate	≤100fps			≤200fps					

STANDARD DELIVERY

Code	UTM-MA1	UTM-MA2	UTM-MA3	UTM-MB1	UTM-MB2	UTM-MB3	UTM-MC1	UTM-MC2	UTM-MC3
Main unit	1 pc	1 pc	1 pc	1 pc	1 pc	1 pc	1 pc	1 pc	1 pc
Computer	1 pc	1 pc	1 pc	1 pc	1 pc	1 pc	1 pc	1 pc	1 pc
Control box	1 pc	1 pc	1 pc	1 pc	1 pc	1 pc	1 pc	1 pc	1 pc
Tripod	1 pc	1 pc	1 pc	1 pc	1 pc	1 pc	1 pc	1 pc	1 pc
Box	1 pc	1 pc	1 pc	1 pc	1 pc	1 pc	1 pc	1 pc	1 pc
Video extensometer module	√	√	√	√	√	√	√	√	√
2D-DIC module		√	√		√	√		√	√
Video strain module			√			√			√
Video displacement module			√			√			√
Video angle module			√			√			√
Fatigue extensometer module			√			√			√

To be continued

Continued from previous page

video extensometer module

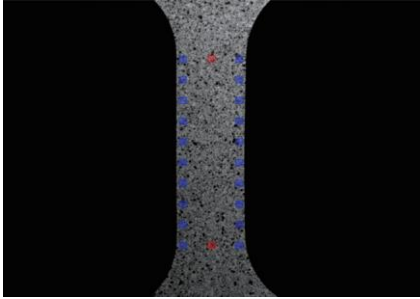

- It is suitable for a wide range of samples, including specimens, parts and machine deformations.
- It can measure different sizes of specimens, customizable from microns to around ten metres.
- It has a wide strain range, customizable from 0.002% to 1000%.
- It has high measurement accuracy and its core algorithms are accurate to sub-pixel level (0.01 pixels).
- Its distance can be customized, it has a wide range of distances to choose from, and the distance within the field of view can be set arbitrarily.
- It enables full-process tracking without downtime and without damaging the measuring device when the sample breaks.
- Its environment is very versatile. It can customize high and low temperature, high pressure, radiation and other scenarios.

2D-DIC module

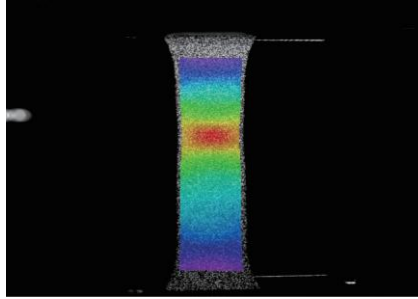

- It can measure over the entire area, which is equivalent to hundreds of virtual strain gauges.
- It is a single-phase frame, which can effectively save the hardware cost.
- It offers high measurement accuracy, with a maximum strain accuracy of better than 0.002%.
- It can measure specimens of different sizes, from a few millimeters to several meters.
- Its processes are traceable and it is possible to analyse the measurement process repeatedly.
- It is possible to select any measurement area for specific analysis of different areas.

video strain module

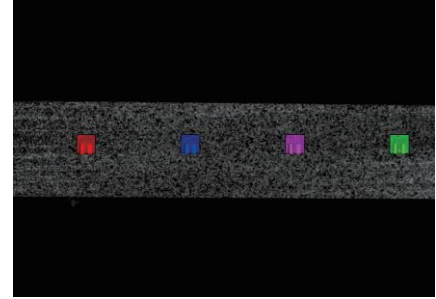

- It is a virtual strain gauge, it is non-contact measurement, it does not require a high material surface.
- It is adjustable in size, it can be set to adjust the size of different strain gauges.
- It has a large measuring range, its strain range is 0.002%~1000%.
- It can be used to measure small samples to solve the problem of conventional strain gauges pasting small samples.
- It can measure multiple data, strain X/Y/XY, maximum/small principal strain, etc.
- It can be used in high and low temperatures to replace the traditional strain gauge testing.
- It is very easy to use, no sanding, gluing, processing to use, it does not need to be set up.
- Its test procedure is traceable, and the measurement process can be repeated and analyzed retrospectively.

video displacement module

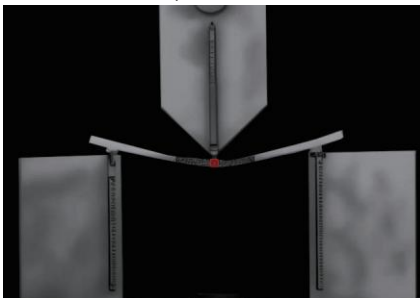

- It is a video sensor that can be adapted to non-contact displacement measurement and monitoring scenarios.
- It is a deflection meter, it can meet the various environments and various scales of deflection testing.
- It is a motion sensor, it can meet the needs of speed and acceleration testing.
- It can test deformable bodies. It is suitable for both rigid and deformable body testing.
- There is no limit to the number of test scenarios it can cover from microns to meters.
- It can perform high-precision testing, it can realize sub-pixel calculation accuracy, it is better than traditional vision.
- It can realize multiple data acquisition, it supports multiple measurement points and displacement X/Y/E test.

video angle module

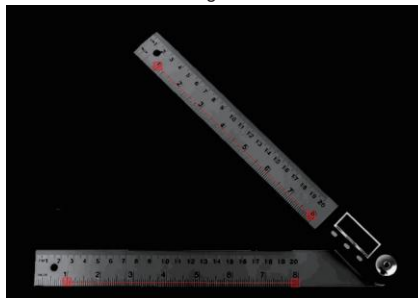

- It allows for non-contact measurements, it requires no hardware connection to the measuring device, and it is easy to use.
- It can perform dynamic angle measurement, it can provide real-time feedback on the change of angle during dynamic testing.
- It can perform single line angle measurement, it can realize the angle measurement in the dynamic change of single line mechanism.
- It can carry out double line angle measurement, it can realize the angle measurement in the dynamic change of double line angle.
- It can perform linearity measurements, which is used to characterize the linearity of the motion of the mechanism in the dynamic test.

fatigue extensometer module

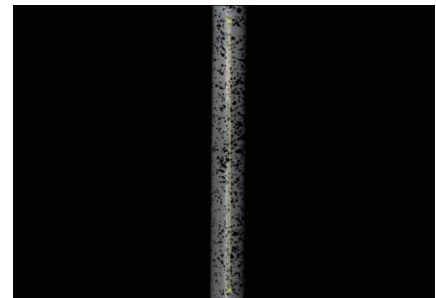















- It can perform non-contact measurements, it can avoid slipping of the jaws and so on.
- It can perform full-cycle testing, it can be a key to deal with low-week fatigue.
- It can run at high frame rates, and it can collect dozens of times the fatigue cycle.
- It can transmit for a long time, and it can realize stable output of large data.
- It can participate in the control, it can through the data on the test machine for the control of related actions.

CUSTOM-MADE

FIXTURES FOR ELECTRONIC UNIVERSAL TESTING MACHINES

- For **UTM-E** series and **UTM-S** series electronic universal testing machines

<p>UTM-F001</p> <ul style="list-style-type: none"> Wedge tensile fixture For tensile testing of non-metallic materials and thin metal specimens 	<p>UTM-F002</p> <ul style="list-style-type: none"> Hydraulic tensile fixture For tensile testing of metallic materials, round bar specimens 	<p>UTM-F003</p> <ul style="list-style-type: none"> 10kN wedge tensile fixture For tensile testing of metal specimens 
<p>UTM-F004</p> <ul style="list-style-type: none"> Pneumatic tensile fixture For tensile testing of non-metallic material specimens 	<p>UTM-F005</p> <ul style="list-style-type: none"> Insulation profile longitudinal shearing fixture Longitudinal shear test for insulation type materials 	<p>UTM-F006</p> <ul style="list-style-type: none"> Insulation profile transverse tensile fixture For transverse tensile testing of insulation-type materials 
<p>UTM-F007</p> <ul style="list-style-type: none"> Filament winding fixture For tensile testing of data wires, textile fabric wires, plastic wires 	<p>UTM-F008</p> <ul style="list-style-type: none"> Filament opposite fixture For tensile testing of wire specimens 	<p>UTM-F009</p> <ul style="list-style-type: none"> Pneumatic threadlet tensile fixture For tensile testing of non-metallic wire specimens 
<p>UTM-F010</p> <ul style="list-style-type: none"> Steel wire tensile fixture For tensile testing of fine steel wires and iron wires 	<p>UTM-F011</p> <ul style="list-style-type: none"> Threadlet winding fixture For tensile testing of filamentary metal specimens 	<p>UTM-F012</p> <ul style="list-style-type: none"> Fabric belt winding tensile fixture For tensile testing of non-metallic material specimens 
<p>UTM-F013</p> <ul style="list-style-type: none"> Film tensile fixture For tensile testing of paper, film and non-metallic materials 	<p>UTM-F014</p> <ul style="list-style-type: none"> Film tensile fixture For tensile testing of paper, film and non-metallic materials 	<p>UTM-F015</p> <ul style="list-style-type: none"> Thin film opposite fixture For tensile testing of paper, film and non-metallic materials 

To be continued

Continued from previous page

<p>UTM-F016</p> <ul style="list-style-type: none"> Thin plate opposite fixture For tensile testing of thin plates of non-metallic materials 	<p>UTM-F017</p> <ul style="list-style-type: none"> Annule tensile fixture For tensile testing of non-metallic annular material specimens 	<p>UTM-F018</p> <ul style="list-style-type: none"> Adhesive tensile shearing fixture For tensile shear testing of different adhesive specimens 
<p>UTM-F019</p> <ul style="list-style-type: none"> Surface bonding strength fixture Tensile testing for adhesive properties 	<p>UTM-F020</p> <ul style="list-style-type: none"> Leverage tensile fixture For tensile testing of rubber, silicone and other elastomers 	<p>UTM-F021</p> <ul style="list-style-type: none"> Rubber tensile fixture Specialized for tensile testing of rubber material specimens 
<p>UTM-F022</p> <ul style="list-style-type: none"> 90° rubber peel fixture Peel test for adhesion of rubber materials 	<p>UTM-F023</p> <ul style="list-style-type: none"> PCB plate 90° peel fixture Peel-off test for adhesion of sticky materials on PCBs 	<p>UTM-F024</p> <ul style="list-style-type: none"> Plastic bending fixture Specialized for flexural testing of plastic specimens 
<p>UTM-F025</p> <ul style="list-style-type: none"> Three-point bending fixture For bending test of various material specimens 	<p>UTM-F026</p> <ul style="list-style-type: none"> Waving fixture For tensile testing of non-metallic specimens 	<p>UTM-F027</p> <ul style="list-style-type: none"> Butt fixture For tensile testing of different materials 
<p>UTM-F028</p> <ul style="list-style-type: none"> Shear fixture For shear testing of different materials 	<p>UTM-F029</p> <ul style="list-style-type: none"> Ceramic shearing fixture Specialized for shear testing of ceramic materials 	<p>UTM-F030</p> <ul style="list-style-type: none"> Compressive fixture For compression testing of different materials 
<p>UTM-F031</p> <ul style="list-style-type: none"> Puncture fixture For film puncture testing 		

IMPACT TESTING MACHINES



ITM-S300J



low-temperature chamber (optional)

- According to GB/T 3808, GB/T 229, JJG 145, ASTM E23 (with American standard blade), ISO 148.1, ISO 148.2, ISO 148.3, ISO R83
- For testing the anti-impact performance of metal materials under dynamic load
- Capable of performing metal impact tests in large quantities on a continuous basis

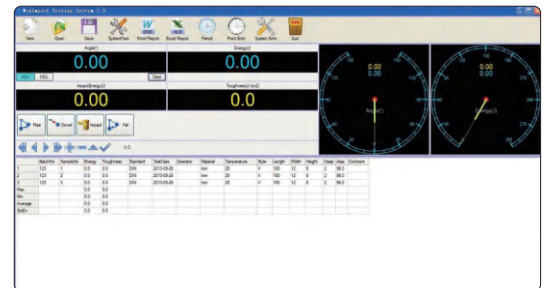

software (included)

SPECIFICATION

Code	ITM-S150J	ITM-S300J	ITM-S450J	ITM-S600J	ITM-S750J
Impact energy	150J	300J	450J	600J	750J
Dial range	0~150J	0~300J	0~450J	0~600J	0~750J
Dial graduation	1J	2J	3J	4J	5J
Pendulum moment	M=80.3848N·m	M=160.7695N·m	M=241.1543N·m	M=321.5390N·m	M=401.9238N·m
Pendulum preparing angle	150°				
Distance between pendulum shaft center and specimen center	750mm				
Impact speed	5.24m/s				
Span of specimen seat	40mm				
End face radius of specimen seat	R (1.0~1.5)mm				
Radius of impact blade	R (2.0~2.5)mm				
Inclination angle of support surface of specimen seat	11°±1°				
Angle of impact blade	30°±1°				
Thickness of impact blade	16mm				
Range of measuring angle	0~360°				
Angle resolution	≤0.06°				
Specimen size	10×10×55mm				
Base size	800×500mm		960×650mm		
Dimension of main body	2050×690×2015mm		2100×835×2200mm		
Weight	450kg		900kg		
Power supply	AC 380V, 3Ø, 50Hz				
Power	400W		1.5kW		

To be continued

Continued from previous page

SPECIFICATION OF LOW-TEMPERATURE CHAMBER (OPTIONAL)

Code	ITM-S-40	ITM-S-60	ITM-S-80	ITM-S-80S	ITM-S-100	ITM-S-196*
Range of temperature	room temperature ~-40°C	room temperature ~-60°C	room temperature ~-80°C	room temperature ~-80°C	room temperature ~-100°C	-20°C~-196°C
Accuracy of temperature control	±0.5°C					±2°C
Evenness	≤1.0°C					≤2.0°C
Resolution	0.1°C					0.1°C
Method of refrigeration	compressor refrigeration					liquid nitrogen refrigeration
Cooling medium	ethanol or other unfrozen liquid					liquid nitrogen
Number of specimen	≥60 pcs					
Cooling speed	+25°C~0°C about 1.5°C/min, 0°C~-20°C about 1.2°C/min, -20°C~-40°C about 1.0°C/min	+25°C~0°C about 1.8°C/min, 0°C~-20°C about 1.5°C/min, -20°C~-40°C about 1.3°C/min, -40°C~-60°C about 1.0°C/min	+25°C~0°C about 1.5°C/min, 0°C~-20°C about 1.3°C/min, -20°C~-60°C about 0.8°C/min		+25°C~0°C about 2.0°C/min, 0°C~-40°C about 1.5°C/min, -40°C~-80°C about 1.3°C/min, -80°C~-100°C about 0.8°C/min	1°C~-3°C
Heating speed	3°C/min					
Timekeeping device	1min~9999min, resolution: 1min					
Volume of refrigeration room (W×D×H)	275×160×120mm					
Effective volume of refrigeration room (W×D×H)	150×140×110mm					
External dimension (W×D×H)	910×510×920mm			755×555×950mm	1105×705×1110mm	710×600×740mm
Material of the case	Iron shell spraying moulding			stainless steels	Iron shell spraying moulding	stainless steels
Power supply	AC220V, 3Ø, 50Hz, 1.8kW	AC220V, 3Ø, 50Hz, 2.3kW	AC220V, 3Ø, 50Hz, 2.5kW	AC220V, 3Ø, 50Hz, 2.5kW	AC 220V, 3Ø, 50Hz, 3.0kW	AC 220V, 3Ø, 50Hz, 100W

* For test >-20°C, ITM-T80 is recommended

STANDARD DELIVERY

Main unit	1 pc	
Control cabinet	1 pc	
Simply supported beam fixture (including jaws, anvil)	1 set	
Pendulum	ITM-S150J	150J pendulum
	ITM-S300J	300J pendulum and 150J pendulum
	ITM-S450J	450J pendulum and 150J pendulum
	ITM-S600J	600J pendulum and 150J pendulum
	ITM-S750J	750J pendulum and 150J pendulum
Span aligner	1 pc	
Tongs	1 pc	
Safety cover	1 set	
Software	1 set	
Computer	1 pc	
Printer	1 pc	

OPTIONAL ACCESSORY

Workbench	7911-15
150J pendulum	ITM-S-PE150J
300J pendulum	ITM-S-PE300J
450J pendulum	ITM-S-PE450J
600J pendulum	ITM-S-PE600J
750J pendulum	ITM-S-PE750J
ASTM standard impact blade	ITM-S-ASTM-IB
Sample recovery device	ITM-S-RD
Digital display screen	ITM-S-DDS
Impact specimen notch projector (GB/T 229, ASTM E23)	ITM-S-1
Low-temperature chamber	ITM-S-40
	ITM-S-60
	ITM-S-80
	ITM-S-80S
	ITM-S-100
ITM-S-196	
Impact specimen notch broaching machine (double broaches)	ITM-U32
Impact standard sample	ITM-BR series

LOW TEMPERATURE AUTOMATIC IMPACT TESTING MACHINES

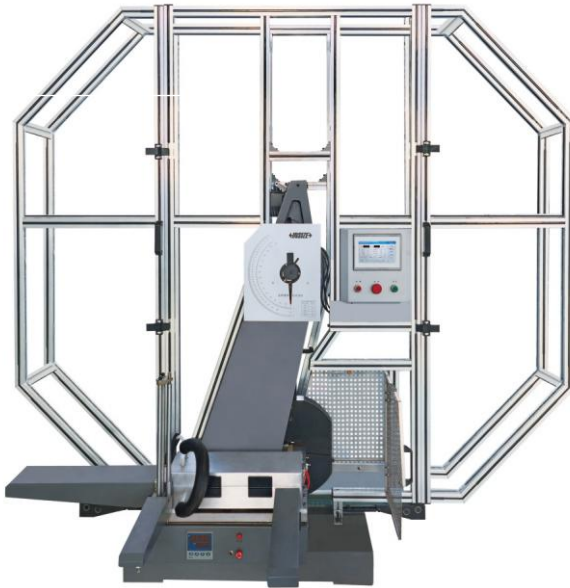

ITM-T300J

- According to GB/T 3808, GB/T 229, JJG 145, ASTM E23 (with American standard blade), ISO 148.1, ISO 148.2, ISO 148.3, ISO R83
- For testing the anti-impact performance of metal materials under dynamic load
- Capable of performing metal impact tests in large quantities on a continuous basis
- Automatic sample feeding and positioning

software (included)

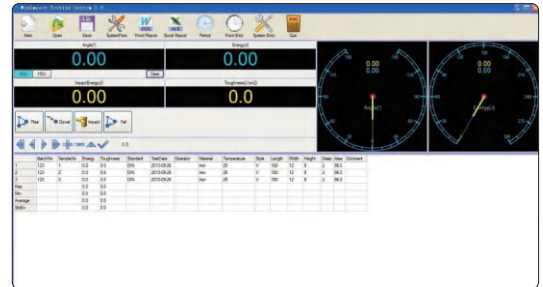

sample feeding and positioning device (included)



low-temperature chamber (optional)

SPECIFICATION

Code	ITM-T150J	ITM-T300J	ITM-T450J	ITM-T600J	ITM-T750J
Impact energy	150J	300J	450J	600J	750J
Dial range	0~150J	0~300J	0~450J	0~600J	0~750J
Dial graduation	1J	2J	3J	4J	5J
Pendulum moment	M=80.3848N·m	M=160.7695N·m	M=241.1543N·m	M=321.5390N·m	M=401.9238N·m
Pendulum preparing angle	150°				
Distance between pendulum shaft center and specimen center	750mm				
Impact speed	5.24m/s				
Span of specimen seat	40mm				
End face radius of specimen seat	R (1.0~1.5)mm				
Radius of impact blade	R (2.0~2.5)mm				
Inclination angle of support surface of specimen seat	11°±1°				
Angle of impact blade	30°±1°				
Thickness of impact blade	16mm				
Range of measuring angle	0~360°				
Angle resolution	≤0.06°				
Specimen size	10×10×55mm				
Base size	960×650mm				
Dimension of main body	2100×835×2200mm				
Weight	900kg				
Power supply	AC380V, 3Ø, 50Hz				
Power	1.5kW				

To be continued

Continued from previous page

SPECIFICATION OF LOW-TEMPERATURE CHAMBER (OPTIONAL)

Code	ITM-T-60	ITM-T-180	ITM-T-196
Range of temperature	room temperature~-60°C	-20°C~-180°C	room temperature~-196°C
Accuracy of temperature control	±0.5°C	±2°C	room temperature~-80°C: ±0.5°C, -80°C~-196°C: ±2°C
Evenness	≤1.0°C	≤2.0°C	room temperature~-80°C: ≤1.0°C, -80°C~-196°C: ≤2.0°C
Resolution	0.1°C	0.1°C	room temperature~-80°C: 0.1°C, -80°C~-196°C: 0.1°C
Method of refrigeration	compressor refrigeration	liquid nitrogen refrigeration	room temperature~-80°C: compressor refrigeration -80°C~-196°C: liquid nitrogen refrigeration
Cooling medium	ethanol or other unfrozen liquid	liquid nitrogen	room temperature~-80°C: compressor refrigeration -80°C~-196°C: liquid nitrogen refrigeration
Cooling speed	+25°C~0°C, about 1.8°C/min 0°C~-20°C, about 1.5°C/min -20°C~-40°C, about 1.3°C/min -40°C~-60°C, about 1.0°C/min	1°C~-3°C	+25°C~0°C, about 2.0°C/min 0°C~-40°C, about 1.5°C/min -40°C~-80°C, about 1.3°C/min -80°C~-196°C, 1°C~-3°C
Heating speed	3°C/min		
Timekeeping device	1min~999min, resolution: 1min		

31

STANDARD DELIVERY

Main unit	1 pc	
Control cabinet	1 pc	
Digital display screen	1 pc	
Sample feeding and positioning device	1 pc	
Sample recovery device	1 pc	
Simply supported beam fixture (including jaws, anvil)	1 set	
Pendulum	ITM-T150J	150J pendulum
	ITM-T300J	300J pendulum and 150J pendulum
	ITM-T450J	450J pendulum and 150J pendulum
	ITM-T600J	600J pendulum and 150J pendulum
	ITM-T750J	750J pendulum and 150J pendulum
Span aligner	1 pc	
Tongs	1 pc	
Safety cover	1 set	
Software	1 set	
Computer	1 pc	
Printer	1 pc	

OPTIONAL ACCESSORY

150J pendulum	ITM-T-PE150J
300J pendulum	ITM-T-PE300J
450J pendulum	ITM-T-PE450J
600J pendulum	ITM-T-PE600J
750J pendulum	ITM-T-PE750J
ASTM standard impact blade	ITM-T-1
Impact specimen notch projector (GB/T 229, ASTM E23)	ITM-T-2
Low-temperature chamber	ITM-T-60, ITM-T-180, ITM-T-196
Workbench	7911-15
Impact specimen notch broaching machine (double broaches)	ITM-U32
Impact standard sample	ITM-BR series

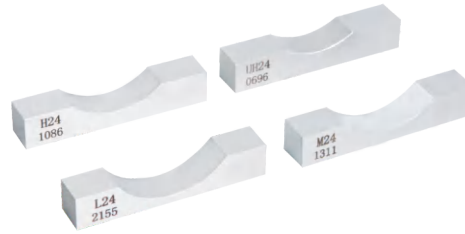

arc standard samples

- It can avoid the defects of the direct test method that cannot accurately evaluate the measurement accuracy of the impact testing machine
- It can comprehensively verify the measurement characteristics of the impact test machine
- It can quantitatively verify the accuracy of the measured value of the impact testing machine
- Ability to evaluate the uncertainty of the test machine
- It has two specifications, national standard R2 and American standard R8, with a size of 55×10×10mm
- Supplied with manufacturer inspection certificate

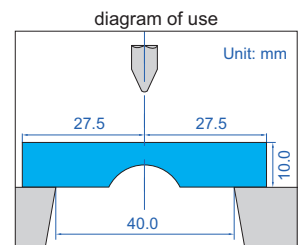

SPECIFICATION

Code	Type of notch	Energy level	Impact blade (mm)	Impact value *	Application temperature
ITM-BR1	arc notch	low: L	R2	28.6J	normal temperature
ITM-BR2	arc notch	medium: M	R2	81.9J	normal temperature
ITM-BR3	arc notch	high: H	R2	127J	normal temperature
ITM-BR5	arc notch	ultra-high: UH	R2	232J	normal temperature
ITM-BR6	arc notch	low: L	R8	29.6J	normal temperature
ITM-BR7	arc notch	medium: M	R8	93J	normal temperature
ITM-BR8	arc notch	high: H	R8	142J	normal temperature
ITM-BR10	arc notch	ultra-high: UH	R8	266J	normal temperature
ITM-BR11	V-notch	low: L	R2	20.7J	normal temperature
ITM-BR12	V-notch	medium: M	R2	107.8J	normal temperature
ITM-BR13	V-notch	high: H	R2	155.9J	normal temperature
ITM-BR14	V-notch	low: L	R8	13.6J	normal temperature
ITM-BR15	V-notch	medium: M	R8	106.1J	normal temperature
ITM-BR16	V-notch	high: H	R8	160J	normal temperature
ITM-BR17	V-notch	low: L	R2	28.6J	-30°C±1°C
ITM-BR18	V-notch	medium: M	R2	81.9J	-30°C±1°C
ITM-BR19	V-notch	high: H	R2	127J	-30°C±1°C
ITM-BR20	V-notch	low: L	R8	29.6J	-30°C±1°C
ITM-BR21	V-notch	medium: M	R8	93J	-30°C±1°C
ITM-BR22	V-notch	high: H	R8	142J	-30°C±1°C

*The actual value may be slightly different when delivered, please refer to the manufacturer inspection certificate

IMPACT SPECIMEN NOTCH BROACHING MACHINE (DOUBLE BROACHES) CODE ITM-U32



- Conforms with ISO 148, ISO 83 and EN 10045 standards
- One-time broaching forming, hydraulic transmission, special internal lubrication device to avoid damage of the broaches
- Dual-station broach, two specimen notches can be processed at the same time



raised broaches

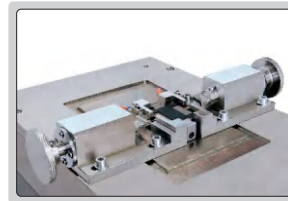

lowered broaches



ITM-U32

SPECIFICATION

Broach stroke	350mm (V2, U2, U3 broaches) 400mm (U5 broach)
Specimen size (T×W×L)	10×10×55mm
Broaching speed	0.35-2.5m/min
Driving method	hydraulic
Power supply	380V, 50Hz, 0.4kW
Dimension	660×400×1200mm
Weight	200kg

STANDARD DELIVERY

Main unit	1 pc
Broach	U2 and V2

OPTIONAL ACCESSORY

U3 broach	ITM-U32-U3
U5 broach	ITM-U32-U5

IMPACT BROACHES



- The broach is made of special material and special process, with high hardness, good wear resistance and long service life
- The processed V-notch and U-notch (2mm) can meet the relevant national standards of GB/T229-2007
- The processing consistency is excellent, which can ensure that the sample is qualified



ITM-UV2

SPECIFICATION

Code	Type of blade	Depth of notch	Radius of bottom	Material	Hardness of material to be cutted
ITM-UV1*	V-shaped	2mm	0.25mm	W ₁₈ Cr ₄ V	Below 42HRC
ITM-UV2*	U-shaped	2mm	1mm	W ₁₈ Cr ₄ V	Below 42HRC
ITM-UV3**	U-shaped	3mm	1mm	—	—
ITM-UV4**	U-shaped	5mm	1mm	—	—

* Hardness of ITM-UV1 and ITM-UV2 blade can be customized for special requirements

** ITM-UV3 and ITM-UV4 need to be customized



FRICION AND WEAR TESTING MACHINE CODE STM-C1

- According to NB/SH/T 0189, ASTM D3702, ASTM G99
- The friction simulation test between different friction parts can be realised under various conditions such as changing temperature, load, speed, friction part material, friction part surface roughness, hardness and lubrication status (oil-free lubrication, oil-drip lubrication or oil-immersion lubrication)
- The machine can simulate rolling, sliding and rolling-sliding compound motion friction form, with a variety of friction sub, such as pin disc (with a large disc and small disc, single needle and three needle) friction sub, four ball friction sub, thrust ring, ball disc and so on
- The machine can complete a variety of point, line and surface friction simulation experiments, can be used to evaluate the lubricant, metal, paint, coatings, rubber, ceramics and other materials friction and wear performance



STM-C1

SPECIFICATION

Maximum axial test force	1000N
Accuracy of axial force	±1%
Load rate of axial test force	400N/min
Retention capacity of axial test force	±1%
Range of friction sensor	200N
Length of friction arm	50mm
Maximum friction torque	2.5N·m
Accuracy friction torque	±2%
Range of spindle speed	5~2000r/min
Accuracy of spindle speed	±1%
Taper of tester spindle	1:7
Maximum distance between spindle and lower sub-disc	>75mm
Timekeeping device	10s~9999min
Range of RPM counter	(1~99)×10 ⁵ times
Dimension of main body	860×740×1560mm
Weight	550kg
Power supply	AC 220V, 50Hz

STANDARD DELIVERY

Main unit	1 pc
Pin and disc friction vice	1 set
Computer	1 pc
Printer	1 pc

OPTIONAL ACCESSORY

Ball and disc friction vice	STM-CF1
Disc and disc friction vice	STM-CF2
Tube heater	STM-CF3
Special accessories	customized

FRICITION/PEEL TESTERS



STM-A10

- According to GB/T 10006, GB/T 2790, GB/T 2791, GB/T 2792, ISO 8295, ISO 8510-2, ASTM D1894, ASTM D4917
- Suitable for plastic film, foil, paper, cardboard, fabrics, communication cables and cables with metal materials composite belt, conveyor belt, paper and other related materials, dynamic and static coefficient of friction and adhesive composite products, medical patches, paper, protective film and other products, peel strength determination
- Seven-inch industrial touch screen, man-machine interface stylish, convenient
- Wide-range, high-precision temperature control device easily realises testing of specimens at different temperatures
- Infinitely variable speed, multi-speed adjustable, to meet the different needs of customers
- The standard test bench and test slider are demagnetised and tested for residual magnetism, effectively reducing systematic testing errors
- The system is controlled by a computer and a microprocessor, making it easy for the user to carry out the test quickly
- Equipped with USB interface, professional measurement and control software, you can control the instrument through the software to complete the test

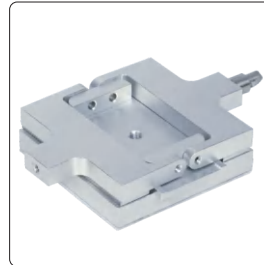

slider (200g)
(included)



connector
(included)



weight (300g)
(included)



retainer block
(included)



peel fixture (included)

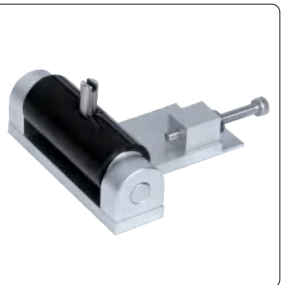

SPECIFICATION

Code	STM-A05	STM-A10	STM-A30
Max. test force	5N	10N	30N
Accuracy of test force	±0.5%		
Resolution of test force	0.001N		
Range of test force	0.5%~100%FS		
Range of speed adjustment	1~600mm/min		
Weight of slider	200g		
Dimension (W×D×H)	850×350×290mm		
Weight	30kg		
Power supply	AC 220V, 50Hz		

STANDARD DELIVERY

Main unit	1 pc
Slider (200g)	1 pc
Connector	1 pc
Weight (300g)	1 pc
Retainer block	1 pc
Peel fixture	1 set
Ø6 polyurethane tube (5m)	1 pc
Fuse	3 pcs
Test board (50×125mm)	3 pcs

OPTIONAL ACCESSORY

Professional software*	STM-AF1	
Communication cable	STM-AF2	
Standard press roller	STM-AF3	
Slider (100g)	STM-AF4	
Weight (800g)	STM-AF5	
Weight (1614g)	STM-AF6	
Weight (1800g)	STM-AF7	
Test board (40×180mm)	STM-AF8	
Stainless steel sampling knives	10mm	STM-AF9
	15mm	STM-AF10
	20mm	STM-AF11
	25mm	STM-AF12
Stainless steel sampling blade (10pcs)	25.4mm	STM-AF13
		STM-AF14
Non-standard fixture	customized, selection of specifications according to test requirements	

*STM-AF2 is required when purchasing STM-AF1

PNEUMATIC KEY LIFE TESTER CODE STM-B1



VIDEO



STM-B1

- Suitable for the life fatigue test of different types of keys such as computer keyboards, mice, mobile phones, calculators, e-books, electronic dictionaries, gamepads, remote controls, conductive rubber keys, and so on
- Multiple products can be tested at the same time, and each product can be tested with multiple points
- Individual switch for each probe
- Alarm at end of test and conductive failure

SPECIFICATION

Test stroke *	30mm
Lifting range of working table *	0~300mm
Number of probes *	40 pcs
Pressure *	100~1000g (controlled by adjusting air pressure)
Minimum distance between two probes of X axis *	15mm
Minimum distance between two probes of Y axis *	40mm
Duration of upward stay	0.1~99.9s
Duration of downward stay	0.1~99.9s
Number of tests	999999999 times
Dimension of main body	600×530×1200mm
Weight	110kg
Power supply	AC 110~220V, 50/60Hz

* Customizable

STANDARD DELIVERY

Main unit	1 pc
Plastic air tube	1 pc

ELECTRONIC TENSILE AND COMPRESSION TESTING MACHINES

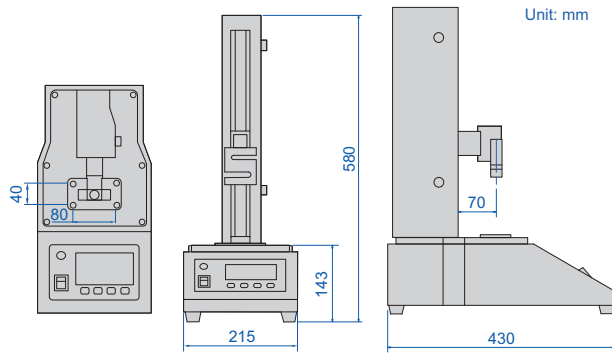

UTM-SC1000



compression fixture (included)



tensile fixture (included)

- Suitable for tensile, peeling and tearing tests of metal wires, metal foils, plastics, food packaging, textile fibres, wires and cables, adhesives, connectors and other industries
- Fixed force test, fixed displacement test, fixed deformation test and cycle test can be realised
- Automatically obtain the maximum force, tensile strength, compressive strength, elongation at break, average peeling strength, average peeling force and other test data
- Overload emergency shutdown protection device, up and down travel limit protection device
- Leakage automatic power-off system, automatic breakpoint stop function

test interface



SPECIFICATION

Code	UTM-SC100	UTM-SC200	UTM-SC500	UTM-SC1000
Max. test force	100N	200N	500N	1000N
Accuracy class	class 0.5			
Test force measurement range	0.4%~100%FS			
Test force measurement accuracy	±0.5% of indicating value			
Test force measurement resolution	0.01N			
Deformation measurement range	0.2%~100%FS			
Deformation measurement accuracy	±0.5% of indicating value			
Deformation measurement resolution	0.001mm			
Displacement range *	0~300mm			
Displacement accuracy	±0.5% of indicating value			
Displacement resolution	0.001mm			
Displacement speed adjustment range	0.1~500mm/min			
Effective tensile travel *	150mm			
Power supply	AC110~220V, 50/60Hz			
Dimension	430×215×580mm			
Weight	15kg			

* Can be customized according to test requirements

STANDARD DELIVERY

Main unit	1 pc
Tensile fixture	1 set
Compression fixture	1 set

OPTIONAL ACCESSORY

Fixture	customized, selection of specifications according to test requirements
---------	--

**DATA
OUTPUT**

- Peak hold and automatic release function
- Set upper and lower limits, red and green indicator and buzzer alarm
- Automatic conversion of three units: N, kgf, lbf
- Built in printer
- Automatic power off

ISF-S10

ISF-S500

ISF-S1000
SPECIFICATION

Code	ISF-S10	ISF-S20	ISF-S30	ISF-S50	ISF-S100	ISF-S200
Maximum load	10N	20N	30N	50N	100N	200N
Resolution	0.001N	0.002N	0.01N	0.01N	0.02N	0.05N
Range of digital scale	65mm	65mm	65mm	95mm	95mm	95mm
Resolution of digital scale	0.01mm	0.01mm	0.01mm	0.01mm	0.01mm	0.01mm
Disk diameter	Ø30mm	Ø30mm	Ø30mm	Ø49mm	Ø49mm	Ø49mm
Maximum free length of spring	65mm	65mm	65mm	95mm	95mm	95mm
Measuring range of force	5%~100% (maximum load)					
Accuracy of force	±1% (maximum load)					
Data output	RS232					
Power supply	220V, 50/60Hz					
Dimension	300×235×600mm	300×235×600mm	300×235×600mm	300×235×620mm	300×235×620mm	300×235×620mm
Weight	13.2kg	13.2kg	13.2kg	17.3kg	19.1kg	19.1kg

Code	ISF-S300	ISF-S500	ISF-S1000	ISF-S2000	ISF-S5000
Maximum load	300N	500N	1000N	2000N	5000N
Resolution	0.1N	0.1N	0.2N	0.5N	1N
Range of digital scale	95mm	95mm	150mm	150mm	150mm
Resolution of digital scale	0.01mm	0.01mm	0.01mm	0.01mm	0.01mm
Disk diameter	Ø49mm	Ø49mm	Ø108mm	Ø108mm	Ø108mm
Maximum free length of spring	95mm	95mm	200mm	200mm	200mm
Measuring range of force	5%~100% (maximum load)				
Accuracy of force	±1% (maximum load)				
Data output	RS232				
Power supply	220V, 50/60Hz				
Dimension	300×235×620mm	300×235×620mm	490×300×920mm	490×300×920mm	490×300×920mm
Weight	19.1kg	20.8kg	47.5kg	47.5kg	47.5kg

STANDARD DELIVERY

Main unit	1 pc
-----------	------

DIGITAL FORCE GAUGES (HIGH ACCURACY)

DATA
OUTPUT

INSPECTION
CERTIFICATE



software flash disk
(included)

printer (optional)



ISF-DF100A
type A



ISF-DF5KA
type B



ISF-DF10KC
type C

- Type A and B can be used for tension and pressure tests, type C is only used for pressure tests
- Peak (max.) and tracking mode
- Units for type A: mN, N, gf, kgf, ozf, lbf, type B: N, kgf, lbf, kN, MPa, type C: N, kgf, lbf, kN, tf, MPa
- Tolerance testing
- 1000 memories
- Automatic power off
- Metal case, touch buttons
- LCD display with backlight
- The display flips over when the bottom faces up
- Overload alarm
- Keyboard signal, can be transmitted to Excel

accessory for type B (included)



accessory for type A (included)

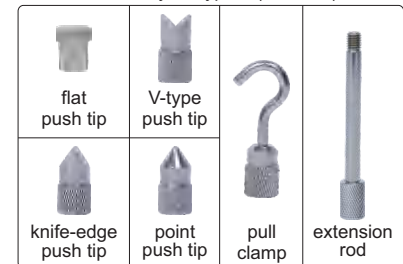

SPECIFICATION

Code	ISF-DF5A	ISF-DF10A	ISF-DF20A	ISF-DF50A	ISF-DF100A	ISF-DF200A	ISF-DF500A	ISF-DF1KA
Type	A (internal sensor)							
Load capacity (N)	5	10	20	50	100	200	500	1000
Resolution (N)	0.0005	0.001	0.005	0.005	0.01	0.05	0.05	0.1
Accuracy	±0.2% (of load capacity)							
Power supply	built-in rechargeable battery							

Code	ISF-DF1KB	ISF-DF2KA	ISF-DF5KA	ISF-DF10KA	ISF-DF20KA
Type	B (external sensor)				
Load capacity (N)	1000	2000	5000	10000	20000
Resolution (N)	0.1	0.5	0.5	1	5
Accuracy	±0.2% (of load capacity)				
Power supply	built-in rechargeable battery				

Code	ISF-DF10KC	ISF-DF20KC	ISF-DF50KC	ISF-DF100KC	ISF-DF200KC
Type	C (external sensor)				
Load capacity (kN)	10	20	50	100	200
Resolution (kN)	0.001	0.005	0.005	0.01	0.05
Accuracy	±0.2% (of load capacity)				
Power supply	built-in rechargeable battery				

STANDARD DELIVERY

Main unit	1 pc	
AC/DC adapter	1 pc	
Software and USB cable	1 pc	
Push/pull accessory	type A	6 pcs (flat push tip, V-type push tip, knife-edge push tip, point push tip, pull clamp, extension rod)
	type B	4 pcs (flat push tip, adapter, pull clamps)

OPTIONAL ACCESSORY

Printer	ISF-DF-PRINTER
Test stand	ISF-MT1K

FORCE GAUGE HANDLES CODE ISF-DFAT1

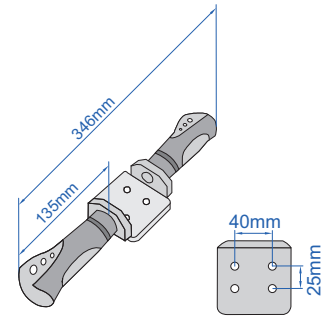

- For digital force gauges (code **ISF-DF**□□□)
- Push and pull test
- Maximum range 1000N

STANDARD DELIVERY

Handle	2 pcs
Base	1 pc

push test with single handle



pull test with two handles



SOFT PROBES FOR HUMAN BODY



ISF-DFAT2-C1

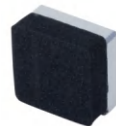

ISF-DFAT2-C2



ISF-DFAT2-C3



ISF-DFAT2-C4

- To measure muscle force
- For press test with digital force gauges (code **ISF-DF**□□□) and force gauge handles (code **ISF-DFAT1**)
- Maximum range 1000N

Code	Specification
ISF-DFAT2-C1	rectangle, 90×25mm, M6
ISF-DFAT2-C2	square, 25×25mm, M6
ISF-DFAT2-C3	arc-shaped, 90×25mm, R80mm, M6
ISF-DFAT2-C4	M6

application



DIGITAL FORCE GAUGES

POPULAR MODEL



DATA OUTPUT

INSPECTION CERTIFICATE



software flash disk (included)



ISF-1DF100

printer (optional)



- Push and pull test
- Units: N, gf, kgf, ozf, lbf
- 500 memories
- Automatic power off
- Metal case
- LCD display with backlight
- The display flips over when the bottom faces up
- Overload alarm

accessory (included)

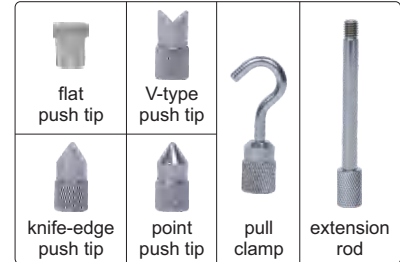

SPECIFICATION

Code	ISF-1DF10	ISF-1DF50	ISF-1DF100	ISF-1DF500	ISF-1DF1000
Load capacity (N)	10	50	100	500	1000
Resolution (N)	0.01	0.01	0.1	0.1	1
Accuracy	±0.3% (of load capacity)				
Measuring mode	tracking, peak (max.), tolerance testing				
Power supply	built-in rechargeable battery				
Dimension	150×73×33mm				
Weight	450g				

STANDARD DELIVERY

Main unit	1 pc
AC/DC adapter	1 pc
Software and USB cable	1 pc
Push/pull accessory	6 pcs (flat push tip, V-type push tip, knife-edge push tip, point push tip, pull clamp, extension rod)

OPTIONAL ACCESSORY

Printer	ISF-DF-PRINTER
Test stand	ISF-MT1K

TEST STAND FOR DIGITAL FORCE GAUGES CODE ISF-MT1K



- For digital force gauges (code ISF-1DF□□□ and ISF-DF□□□)
- To be used in vertical and horizontal orientation

SPECIFICATION

Load capacity	1000N
Travel	200mm (3mm vertical movement per revolution of handwheel)
Dimension	196×250×446mm
Weight	13kg

OPTIONAL ACCESSORY

Digital scale (range: 200mm, resolution: 0.01mm/0.0005")	ISF-MT1K-SCALE
--	----------------

force gauge is optional



digital scale (optional)



horizontal orientation test

FORCE GAUGES



ISF-F500

- Push and pull test
- Peak (max.) or tracking mode

accessory (included)

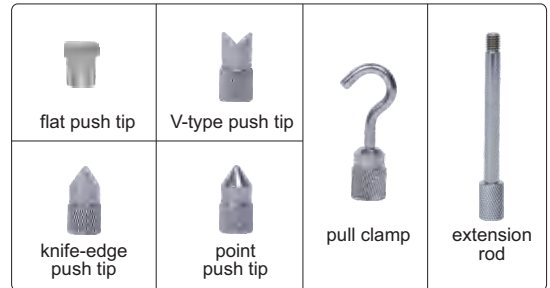

SPECIFICATION

Code		ISF-F10	ISF-F20	ISF-F30	ISF-F50	ISF-F100	ISF-F200	ISF-F300	ISF-F500
Capacity	N	10	20	30	50	100	200	300	500
	kgf	1	2	3	5	10	20	30	50
Graduation	N	0.05	0.1	0.2	0.25	0.5	1	2	2.5
Accuracy		±1% (of load capacity)							

STANDARD DELIVERY

Main unit	1 pc
Push tip	4 pcs (flat, V-type, knife-edge, point)
Pull clamp	1 pc
Extension rod	1 pc

OPTIONAL ACCESSORY

Test stand	ISF-MT500
------------	-----------



TEST STAND FOR FORCE GAUGE
CODE ISF-MT500

- For force gauges (code ISF-F□□□)
- To be used in vertical and horizontal orientation

force gauge is optional



horizontal orientation test

SPECIFICATION

Load capacity	500N
Travel	150mm (3mm vertical movement per revolution of handwheel)
Dimension	160×240×460mm
Weight	12kg

PUSH TIPS AND PULL CLAMPS FOR FORCE GAUGES

■ For force gauges (code ISF-DF□□□, ISF-1DF□□□ and ISF-F□□□)

Unit: mm

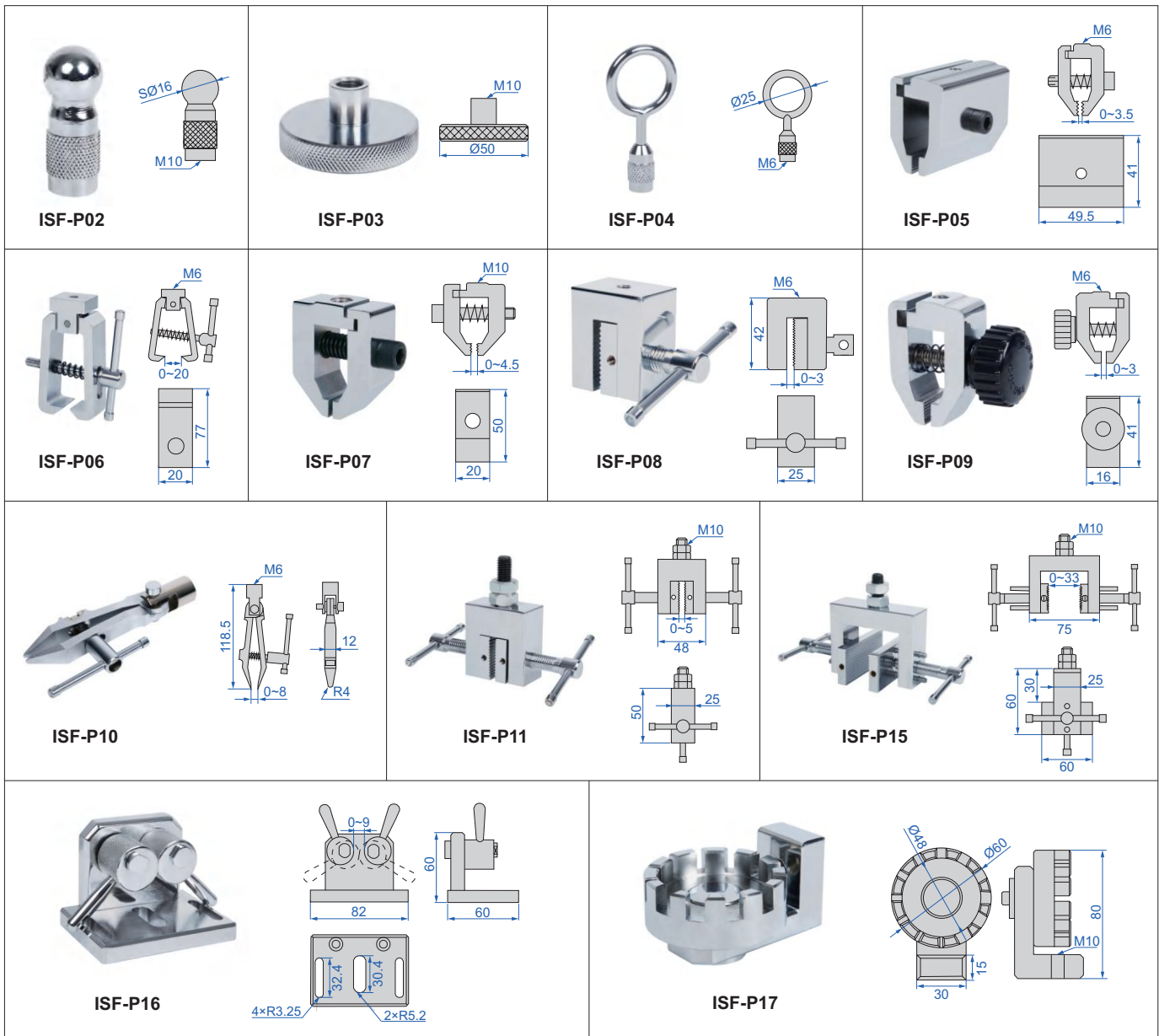

Push tips

Code	Max. load	Diameter	Weight
ISF-P02	5000N	16mm	33g
ISF-P03	3000N	50mm	17g

Pull ring

Code	Max. load	Diameter	Weight
ISF-P04	500N	25mm	158g

Special pull clamps

Code	Max. load	Opening size	Application	Weight
ISF-P16	2400N	0~9mm	for wire pull test	803g
ISF-P17	5000N	1.8~8.4mm	for wire terminal pull test	620g

Pull clamps

Code	Max. load	Jaw opening	Jaw width	Weight
ISF-P05	1100N	0~3.5mm	49.5mm	241g
ISF-P06	1000N	0~20mm	20mm	217g
ISF-P07	500N	0~4.5mm	20mm	190g
ISF-P08	500N	0~3mm	25mm	274g
ISF-P09	140N	0~3mm	16mm	87g
ISF-P10	230N	0~8mm	4mm	173g
ISF-P11	1500N	0~5mm	25mm	484g
ISF-P15	2000N	0~33mm	60mm	742g



MOTORIZED VERTICAL TEST STAND CODE ISF-RV61

- For digital force gauges (code **ISF-1DF** and **ISF-DF**)
- Push and pull test
- Automatic and manual test
- Programmable automatic operation (automatic cycle)
- Four operation modes: displacement cycle (D cycle), force cycle (F cycle), demo (teaching & playback) mode and positioning mode
- Alarm indications: stroke overrange alarm, force overrange alarm, motor block alarm

SPECIFICATION

Load capacity	650N (250lbf, 65kg)
Max. travel	220mm
Resolution of displacement	0.01mm
Accuracy of displacement	±0.3mm
Range of adjustable speed	30~720mm/min
Resolution of speed	1mm/min
Accuracy of speed	±2%
Data output	USB, RS232
Work temperature and relative humidity	10~40°C, 10%~80%RH
Power supply	100~230V
Dimension	340×180×630mm
Weight	15.5kg

digital force gauge
is optional



STANDARD DELIVERY

Test stand	1 pc
AC/DC adapter	1 pc
MD8 cable (for force gauges)	1 pc
Software and USB cable	1 pc



MOTORIZED HORIZONTAL TEST STAND CODE ISF-RH62

- For digital force gauges (code **ISF-1DF** and **ISF-DF**)
- Push and pull test
- Automatic and manual test
- Programmable automatic operation (automatic cycle)
- Four operation modes: displacement cycle (D cycle), force cycle (F cycle), demo (teaching & playback) mode and positioning mode
- Alarm indications: stroke overrange alarm, force overrange alarm, motor block alarm

SPECIFICATION

Load capacity	650N (250lbf, 65kg)
Max. travel	220mm
Resolution of displacement	0.01mm
Accuracy of displacement	±0.3mm
Range of adjustable speed	30~720mm/min
Resolution of speed	1mm/min
Accuracy of speed	±2%
Data output	USB, RS232
Work temperature and relative humidity	10~40°C, 10%~80%RH
Power supply	100~230V
Dimension	671×120×278mm
Weight	13kg

digital force gauge
is optional



STANDARD DELIVERY

Test stand	1 pc
AC/DC adapter	1 pc
MD8 cable (for force gauges)	1 pc
Software and USB cable	1 pc

MANUAL VERTICAL TEST STANDS FOR FORCE GAUGES



ATTENTION:
ONLY FOR PRESS TEST

force gauge
is optional



ISF-V10A

- For press test with force gauges

SPECIFICATION

Code	ISF-V10A	ISF-V10D
Apply to	dial force gauges (code ISF-F□□□)	digital force gauges (code ISF-1DF□□□ and ISF-DF□□□)
Load capacity	500N	
Maximum workpiece height	280mm	
Travel	70mm	
Dimension	152×235×425mm	
Weight	10.7kg	

MANUAL HORIZONTAL TEST STANDS FOR FORCE GAUGES



ATTENTION:
ONLY FOR PULL TEST

force gauge
is optional



ISF-H20A

- For pull test with force gauges

SPECIFICATION

Code	ISF-H20A	ISF-H20D
Apply to	dial force gauges (code ISF-F□□□)	digital force gauges (code ISF-1DF□□□ and ISF-DF□□□)
Load capacity	500N	
Travel	60mm	
Dimension	450×185×170mm	
Weight	9kg	



MANUAL HORIZONTAL TEST STAND FOR FORCE GAUGES CODE ISF-MH2



- For force gauges (code **ISF-F**□□□, **ISF-DF**□□□ and **ISF-1DF**□□□)
- Push and pull test

SPECIFICATION

Load capacity	1000N
Travel	250mm (1.5mm horizontal movement per revolution of handwheel)
Dimension	542×189×278mm
Weight	21.5kg



MANUAL STRIPPING FORCE TEST STANDS

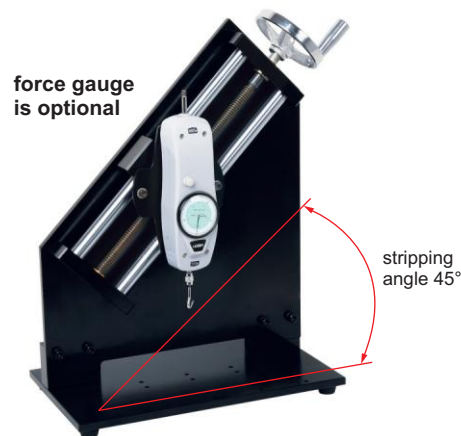

ISF-P30A

- For stripping force test with force gauges

SPECIFICATION

Code	ISF-P30A	ISF-P30D
Apply to	dial force gauges (code ISF-F □□□)	digital force gauges (code ISF-1DF □□□ and ISF-DF □□□)
Load capacity	500N	
Horizontal travel	170mm	
Dimension	420×215×480mm	
Weight	22kg	

FORCE GAUGES



ISF-YT100

accessory (included)

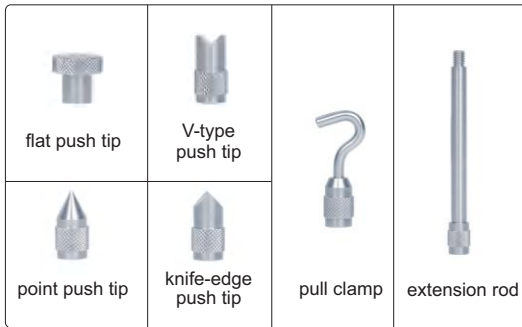

- Force unit: N, g, kg
- Sampling frequency: 50Hz~3200Hz, four adjustable steps, high sampling rate captures peak value accurately
- Select to display the real-time curve and the last historical curve
- Realtime automatic capture of peak value and valley value
- Parameter backup and restoration, even if the parameters are messed up, you can restore them with a single click
- Weightless calibration, just enter the sensor parameters and you are ready for calibration
- A variety of alarm options: upper limit alarm, lower limit alarm, peak and valley alarm, over 1.2 times of the range alarm
- Power supply 3.5V
- Temperature drift less than 20ppm

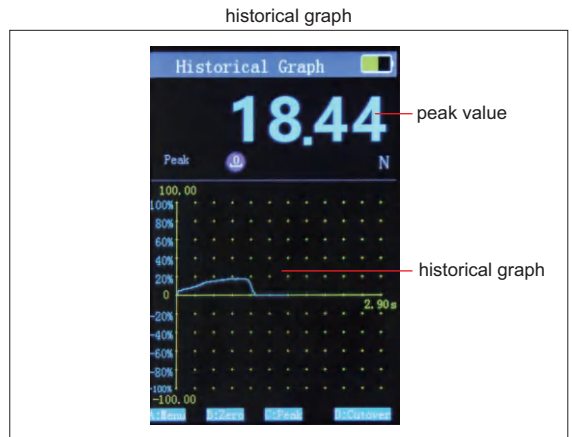
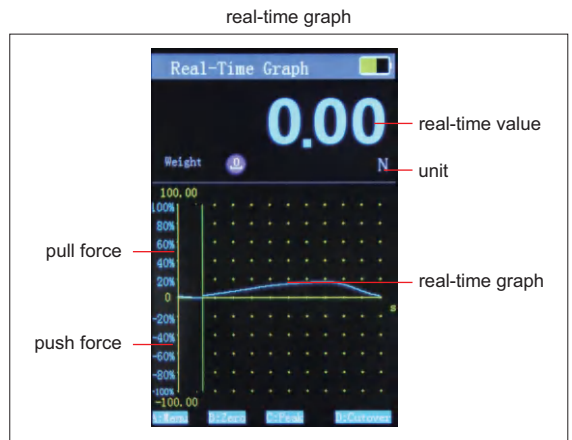
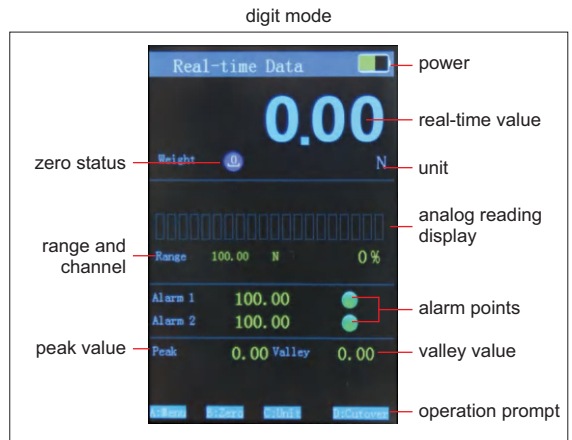

SPECIFICATION

Code	ISF-YT10	ISF-YT20	ISF-YT30	ISF-YT50	ISF-YT100	ISF-YT200	ISF-YT300	ISF-YT500
Type	internal sensor							
Load capacity	10N	20N	30N	50N	100N	200N	300N	500N
Resolution	0.001N	0.001N	0.001N	0.001N	0.01N	0.01N	0.01N	0.1N
Accuracy	±0.2%FS							
Power supply	built-in rechargeable battery							

STANDARD DELIVERY

Main unit	1 pc
Push/pull accessory	6 pcs (flat push tip, V-type push tip, knife-edge push tip, point push tip, pull clamp, extension rod)
Type-C cable	1 pc



S-TYPE TENSILE/COMPRESSION SENSORS

- Characteristic: bi-directional tension and compression, compact structure, high comprehensive precision, good long-term stability and nickel plating on the surface of high-quality alloy steel
- Application fields: universal material testing machines, hopper scales, hook scales, packaging scales, belt scales, plug-in force testers and other tension and pressure testing instruments as well as automation equipments



8650-10K

diagram of connector

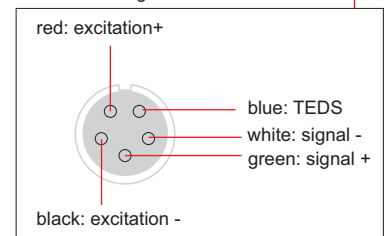

SPECIFICATION

Output sensitivity	2.0±10% mV/V
Zero output	±1%F.S.
Non-linearity	±0.03%F.S.
Hysteresis	±0.03%F.S.
Repeatability	±0.03%F.S.
Creep (30 minutes)	±0.03%F.S.
Temperature sensitivity drift	±0.03%F.S./10°C
Zero temperature drift	±0.05%F.S./10°C
Response frequency	10kHz
Material	alloy steel
Electrical impedance	350Ω
Insulation impedance	≥5000MΩ/100VDC
Operation voltage	5~15V
Working temperature	-20~80°C
Safety overload	150%
Extreme overload	200%
Cable specification	Ø5mm: ≤1T, 2m; >1T, 5m
Extreme cable pulling force	10kg

force diagram of sensor

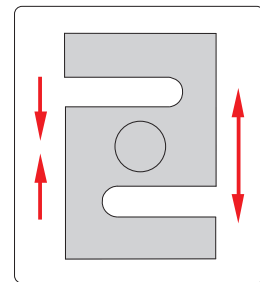

(mm)

Code	Maximum range	A	B	C	D
8650-50	50N/5kg	M18×1.25	12.7	50.8	63.5
8650-100	100N/10kg				
8650-200	200N/20kg				
8650-300	300N/30kg				
8650-500A	500N/50kg				
8650-500B	500N/50kg	M12×1.75	19	76.2	
8650-1K	1000N/100kg				
8650-2K	2000N/200kg				
8650-3K	3000N/300kg				
8650-5K	5000N/500kg				
8650-10K	10kN/1T	M18×1.5	25.4	76.2	108
8650-15K	15kN/1.5T				
8650-20K	20kN/2T				
8650-30K	30kN/3T				
8650-50K	50kN/5T				

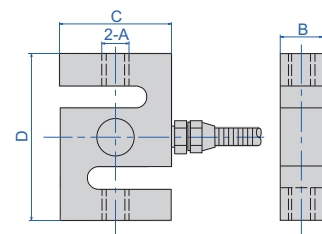

connected with handheld indicator



OPTIONAL ACCESSORY

Handheld force/torque indicator

ISF-DG series

TUBE FORCE GAUGES

- Suitable for measuring weight and tensile forces

SPECIFICATION

Code	8603-10	8603-20	8603-30	8603-50	8603-100	8603-200
Max. test force	10N/1kg	20N/2kg	30N/3kg	50N/5kg	100N/10kg	200N/20kg
Resolution	0.2N/0.02kg	0.4N/0.04kg	0.5N/0.05kg	1N/0.1kg	2N/0.2kg	4N/0.4kg
Unit	kg, N					
Accuracy	±2%FS					
Tube diameter (Ød)	22mm	22mm	22mm	22mm	25mm	32mm
Overall length (L)	280mm	280mm	280mm	280mm	340mm	340mm
Weight	280g	280g	280g	280g	480g	700g
Operation temperature	-10~40°C					
Operation humidity	30%~90%RH					
Maximum safe load	120%FS					
Limited overload	240%FS					

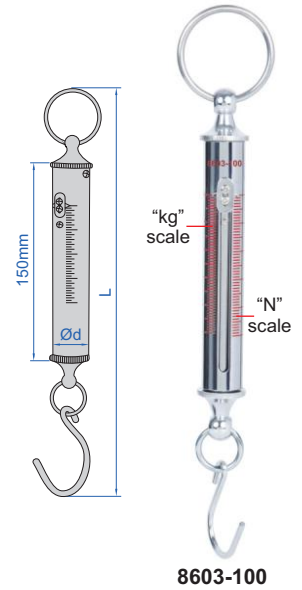

HANG SCALES

REFER TO PAGE
1179-1180 FOR DETAILS



8206-3T



8207-3T

DIAL TENSION GAUGES

- Clockwise and counter-clockwise use
- For electronic and precision mechanical industry, such as test the contact pressure of relay, adjust the tension or compression of spring

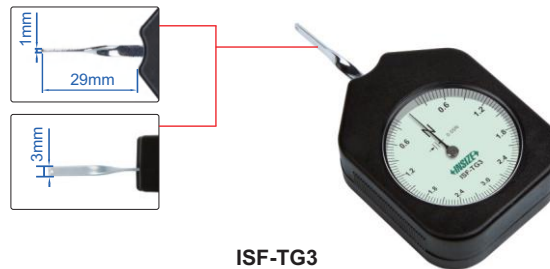

ISF-TG3

SPECIFICATION (Unit: N)

Code	ISF-TGD1	ISF-TGD3	ISF-TGD5	ISF-TG1	ISF-TG1D5	ISF-TG3	ISF-TG5
Range (N)	0.01~0.1	0.03~0.3	0.05~0.5	0.1~1	0.15~1.5	0.3~3	0.5~5
Graduation (N)	0.002	0.005	0.01	0.02	0.025	0.05	0.1
Accuracy	±2% (full scale)						
Dimension (L×W×H)	90×47×19mm						
Weight	60g						

SPECIFICATION (Unit: gf)

Code	ISF-TG10	ISF-TG30	ISF-TG50	ISF-TG100	ISF-TG150	ISF-TG300	ISF-TG500
Range (gf)	1~10	3~30	5~50	10~100	15~150	30~300	50~500
Graduation (gf)	0.2	0.5	1	2	2.5	5	10
Accuracy	±2% (full scale)						
Dimension (L×W×H)	90×47×19mm						
Weight	60g						

WIRE TENSION METERS

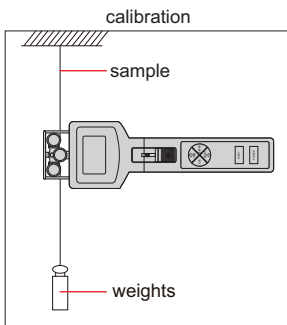

ISF-DT1000

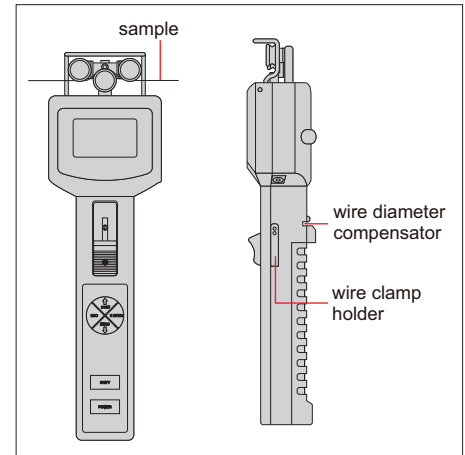

- Suitable for testing the tension of stranding machines, winding machines, wire cutting machines, carbon fibre winding equipments, fibre optic winding equipments, fibre optic cable production equipments, glass fibre winding equipments, steel cord production equipments, steel wire rope production equipments and so on
- Automatic zeroing, manual zeroing also possible
- Memory function for recording the current real-time value (up to 10 data), for recording phase data (max., min., average)
- 10 calibration channels, 6 groups of calibration points to choose from
- Fine-tunable compensation, compensation value range $\pm 10\%$ FS, 1% for one component
- Six units g, cN, N, lb, daN, kg are automatically converted
- 3 min no operation auto shutdown

STANDARD DELIVERY

Main unit 1 pc

SPECIFICATION

Code	ISF-DT200	ISF-DT500	ISF-DT1000	ISF-DT2000	ISF-DT2500	ISF-DT5000	ISF-DT10K	ISF-DT20K
Accuracy class	$\pm 2\%$ FS							
Range of test force	2.0~200.0cN	5.0~500.0cN	10~1000cN	20~2000cN	25~2500cN	50~5000cN	1.0~100.0N	2.0~200.0N
Test force resolution	0.1cN	0.1cN	1cN	1cN	1cN	1cN	0.1N	0.1N
Width of measuring head	65mm	65mm	65mm	116mm	116mm	116mm	116mm	216mm
Factory calibrated wire diameter	$\varnothing 0.2$ mm	$\varnothing 0.2$ mm	$\varnothing 0.4$ mm	$\varnothing 0.4$ mm	$\varnothing 0.4$ mm	$\varnothing 1.2$ mm	$\varnothing 1.2$ mm	$\varnothing 1.8$ mm
Range of diameter	0.05~0.3mm	0.05~0.3mm	0.1~0.5mm	0.3~0.7mm	0.3~0.7mm	0.4~1.0mm	0.7~1.2mm	1.0~1.8mm
Compensation for diameter	yes							
Frequency of display update	2 times/sec							
Maximum line speed	2000 m/min							
Power supply	built-in rechargeable battery							
Environmental requirement	temp: 10~45°C humidity: $\leq 90\%$ RH							

Code	ISF-DT30K	ISF-DT50K	ISF-DT60K	ISF-DT100K	ISF-DT200K
Accuracy class	$\pm 2\%$ FS				
Range of test force	3.0~300.0N	5.0~500.0N	6.0~600.0N	10~1000N	20~2000N
Test force resolution	0.1N	0.1N	0.1N	1N	1N
Width of measuring head	216mm	216mm	216mm	216mm	280mm
Factory calibrated wire diameter	$\varnothing 2$ mm wire rope	$\varnothing 2$ mm wire rope	$\varnothing 2$ mm wire rope	$\varnothing 2$ mm wire rope	$\varnothing 2$ mm wire rope
Range of diameter	≤ 3 mm	≤ 3 mm	≤ 3 mm	≤ 3 mm	≤ 3 mm
Compensation for diameter	yes				
Frequency of display update	2 times/sec				
Maximum line speed	2000 m/min				
Power supply	built-in rechargeable battery				
Environmental requirement	temp: 10~45°C humidity: $\leq 90\%$ RH				

LASER BELT TENSION METER CODE 5900-HZ18

- Laser sensor, direct measurement, easy to use
- Two sensors: internal and external, external sensor is suitable for measurement in narrow spaces
- Automatic power off

SPECIFICATION

Measuring range		10~800Hz
Input parameter range		maximum free belt length: 99.99m maximum belt weight: 9.999kg/m
Accuracy		±5%
Unit		N, lbf
Measuring distance		3~20mm
Operation temperature		10~50°C
Power supply		4×1.5V AAA batteries
Dimension	main unit	178×72×34mm
	external sensor	124×21×12mm
Weight		180g



external sensor

internal sensor

STANDARD DELIVERY

Main unit	1 pc
External sensor	1 pc

31

SONIC BELT TENSION METER CODE 5910-HZ5K

- The sonic belt tension meter uses a microphone probe to capture the sound waves generated by the belt vibration, and can measure the waveform period, and then calculate the tension value by the frequency of the weekly wave
- Can store 500 sets of measurement data, comes with 48 sets of belt data, no need to manually input every time
- Automatic filtering of noise interference, suitable for measurement in small spaces
- Easy operation, one-handed operation
- Lightweight and portable

SPECIFICATION

Frequency range		10~5000Hz
Tension range		0.01~99900N
Input parameter range	belt mass:	0~999.9g/m
	belt width:	0~999.9mm/R
	belt span:	0~9999mm
Unit		N
Accuracy		±1%
Operation temperature		10~50°C
Dimension		160×59×27mm
Power supply		2×1.5V AAA batteries
Weight		150g



hammer (included)

STANDARD DELIVERY

Main unit	1 pc
Standard sensor	1 pc
Hammer	1 pc

SPINDLE TENSION METERS



RFS-BT40

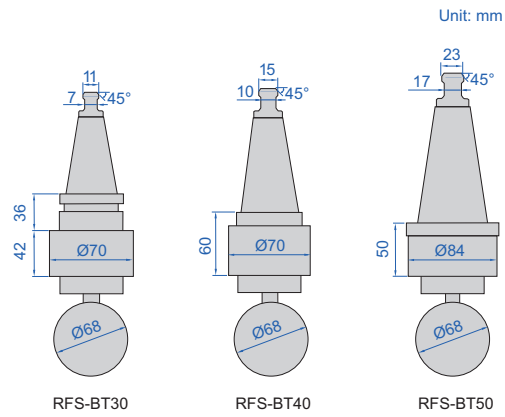

RFS-HSK63A

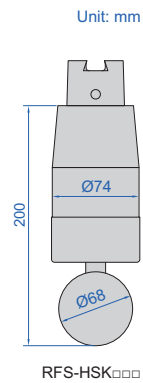

- Hydraulic mechanical structure, high stability
- To detect the tension of locking device

RFS-BT□□ SPECIFICATION

Code	Taper	Dial range*	Accuracy	Applicable tension of spindle	Rivet angle**
RFS-BT30	BT30	0~100kg/cm ²	±1.6kg/cm ²	200~500kgf	45°
RFS-BT40	BT40	0~160kg/cm ²	±2.6kg/cm ²	500~1100kgf	
RFS-BT50	BT50	0~250kg/cm ²	±4kg/cm ²	1500~2200kgf	

RFS-SK□□ SPECIFICATION

Code	Taper	Dial range*	Accuracy	Applicable tension of spindle
RFS-SK30	SK30/JT30	0~100kg/cm ²	±1.6kg/cm ²	200~500kgf
RFS-SK40	SK40/JT40	0~160kg/cm ²	±2.6kg/cm ²	500~1100kgf
RFS-SK50	SK50/JT50	0~250kg/cm ²	±4kg/cm ²	1500~2200kgf

To be continued

Continued from previous page

RFS-CAT□□ SPECIFICATION

Code	Taper	Dial range *	Accuracy	Applicable tension of spindle
RFS-CAT30	CAT30	0~100kg/cm ²	±1.6kg/cm ²	200~500kgf
RFS-CAT40	CAT40	0~160kg/cm ²	±2.6kg/cm ²	500~1100kgf
RFS-CAT50	CAT50	0~250kg/cm ²	±4kg/cm ²	1500~2200kgf

RFS-HSK□□ SPECIFICATION

Code	Taper	Dial range *	Accuracy	Applicable tension of spindle
RFS-HSK20A	HSK20A	0~100kg/cm ²	±1.6kg/cm ²	50~100kgf
RFS-HSK20C	HSK20C			
RFS-HSK20E	HSK20E			
RFS-HSK25A	HSK25A	0~100kg/cm ²	±1.6kg/cm ²	250~500kgf
RFS-HSK25C	HSK25C			
RFS-HSK25E	HSK25E			
RFS-HSK32A	HSK32A	0~100kg/cm ²	±1.6kg/cm ²	300~600kgf
RFS-HSK32B	HSK32B			
RFS-HSK32C	HSK32C			
RFS-HSK32D	HSK32D			
RFS-HSK32E	HSK32E			
RFS-HSK32F	HSK32F			
RFS-HSK40A	HSK40A	0~250kg/cm ²	±4.0kg/cm ²	750~1500kgf
RFS-HSK40B	HSK40B			
RFS-HSK40C	HSK40C			
RFS-HSK40D	HSK40D			
RFS-HSK40E	HSK40E			
RFS-HSK40F	HSK40F			
RFS-HSK50A	HSK50A	0~350kg/cm ²	±5.6kg/cm ²	1000~2000kgf
RFS-HSK50B	HSK50B			
RFS-HSK50C	HSK50C			
RFS-HSK50D	HSK50D			
RFS-HSK50E	HSK50E			
RFS-HSK50F	HSK50F			
RFS-HSK63A	HSK63A	0~350kg/cm ²	±5.6kg/cm ²	1500~3000kgf
RFS-HSK63B	HSK63B			
RFS-HSK63C	HSK63C			
RFS-HSK63D	HSK63D			
RFS-HSK63E	HSK63E			
RFS-HSK63F	HSK63F			
RFS-HSK80A	HSK80A	0~600kg/cm ²	±9.6kg/cm ²	2000~4000kgf
RFS-HSK80B	HSK80B			
RFS-HSK80C	HSK80C			
RFS-HSK80D	HSK80D			
RFS-HSK80E	HSK80E			
RFS-HSK80F	HSK80F			
RFS-HSK100A	HSK100A	0~600kg/cm ²	±9.6kg/cm ²	4000~5500kgf
RFS-HSK100B	HSK100B			
RFS-HSK100C	HSK100C			
RFS-HSK100D	HSK100D			
RFS-HSK100E	HSK100E			
RFS-HSK100F	HSK100F			

* The actual tension of spindle (kgf) is 10X of dial reading

** Can be customized for 60° and 90°



Torsion Testing Machines
Page 987-988



Torque Testers
Page 989



Bottle Cap Torque Testers
Page 990



Torque Testers
Page 991-993



Torque Wrench Test Stands
Page 994-995



Torque Sensors
Page 996-998



Handheld Force/Torque
Indicators
Page 999



Torque Screwdrivers
Page 1000-1001



Electric Screwdrivers
Page 1002-1004



Desktop Automatic
Tightening Machines
Page 1005



Torque Wrenches
Page 1006-1032



Torque Adapters
Page 1034



Torque Multipliers
Page 1035-1037

ELECTRONIC TORSION TESTING MACHINES

OPTIONAL ACCURACY CLASS:
CLASS 0.5



UTM-TT5
Type A



UTM-TT500
Type B

computer and software (included)

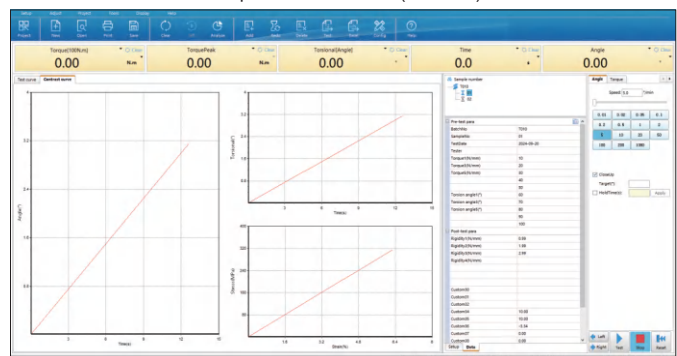

- Suitable for torsion testing of metallic and non-metallic materials, composite materials and components
- Servomotor drive for constant torsion speed
- Cycloid reducer drive for high efficiency and smoothness of transmission
- Electrical control system for high stability, smooth and reliable operation, fast response and low noise
- High-precision linear guide for the coaxiality and parallelism of the equipment
- Automatic torque and torsion angle tracking measurement, load rate indication, peak hold, etc.
- Efficient and professional control software
- Powerful data and curve analysis

To be continued



Continued from previous page

SPECIFICATION

Code	UTM-TT2	UTM-TT5	UTM-TT10	UTM-TT30	UTM-TT50
Max. test torque	2N.m	5N.m	10N.m	30N.m	50N.m
Type	A				
Accuracy class	class 1				
Accuracy of test torque	±1% of indicated value				
Range of test torque	2%~100%FS				
Min. resolution of test torque	0.0001N.m	0.0001N.m	0.001N.m	0.001N.m	0.001N.m
Accuracy of torsion angle	±1% of indicated value				
Range of torsion angle	0~9999°				
Resolution of torsion angle	0.01°				
Rated speed of torsion angle	2160°/min				
Accuracy of torsion angle speed	±1% of the set value				
Accuracy of constant load torque	±1% of the set value				
Direction of torsion test	clockwise and count-clockwise operation				
Height of spindle center *	108mm				
Max. distance between collets *	300mm				
Dimension (W×D×H) *	1100×330×450mm				
Weight *	130kg				
Power supply	AC 220V, 50Hz				

Code	UTM-TT200	UTM-TT500	UTM-TT1000	UTM-TT3000	UTM-TT5000
Max. test torque	200N.m	500N.m	1000N.m	3000N.m	5000N.m
Type	B				
Accuracy class	class 1				
Accuracy of test torque	±1% of indicated value				
Range of test torque	2%~100%FS				
Min. resolution of test torque	0.01N.m	0.01N.m	0.1N.m	0.1N.m	0.1N.m
Accuracy of torsion angle	±1% of indicated value				
Range of torsion angle	0~9999°				
Resolution of torsion angle	0.01°				
Rated speed of torsion angle	1080°/min				
Accuracy of torsion angle speed	±1% of the set value				
Accuracy of constant load torque	±1% of the set value				
Direction of torsion test	clockwise and count-clockwise operation				
Height of spindle center *	146mm			203mm	
Max. distance between collets *	500mm				
Dimension (W×D×H) *	1620×400×1020mm			2350×740×1390mm	
Weight *	260kg			680kg	
Power supply	AC 220V, 50Hz, 0.4kW~1kW			AC 380V, 3Ø, 50Hz, 2kW~4kW	

* Can be customized according to test requirements

STANDARD DELIVERY

Main unit	1 pc
Measuring software	1 set
Computer	1 pc
Printer	1 pc
Security cover	1 pc

OPTIONAL ACCESSORY

Torsion fixture	customized according to test requirements
-----------------	---

DIGITAL TORQUE TESTERS

DATA
OUTPUT



32

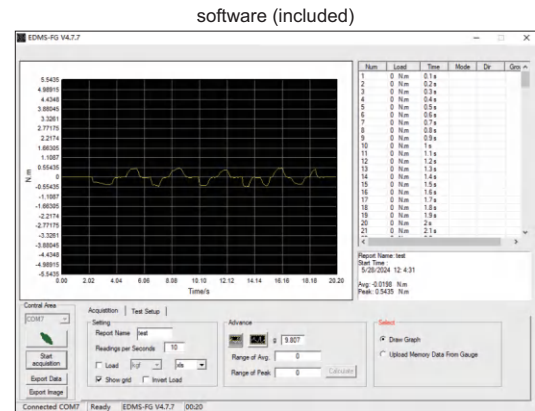
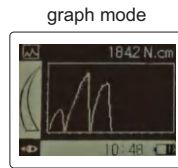
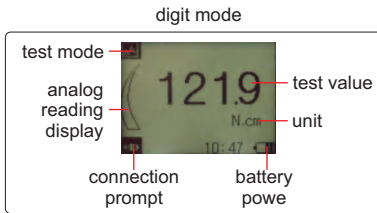

- External sensor
- Metal case, touch buttons
- Clockwise and counter-clockwise operation
- Test mode: track, peak, first peak, preset tolerance
- Unit: lbf.in, lbf.ft, N.m, N.cm, kgf.cm
- Set tolerance with judgement
- 1000 memories
- LCD display with backlight, can automatically turn 180°
- Overload alarm
- Automatic power off

SPECIFICATION

Code	IST-DTT1	IST-DTT5	IST-DTT10	IST-DTT1S	IST-DTT5S	IST-DTT10S
Load capacity	0.05~1N.m	0.25~5N.m	0.5~10N.m	0.05-1N.m	0.25-5N.m	0.5-10N.m
Resolution	0.0001N.m	0.0005N.m	0.001N.m	0.0001N.m	0.0005N.m	0.001N.m
Max. clamping diameter	Ø10mm	Ø10mm	Ø13mm	Ø50mm	Ø50mm	Ø50mm
Type	A			B		
Sampling frequency	2000Hz					
Accuracy	±0.3% (of load capacity)					
Output	USB, RS232, alarm signal					
Power supply	built-in rechargeable battery					
Dimension	145×73×34mm					
Weight	1.4kg					

STANDARD DELIVERY

Main unit	1 pc
External sensor	1 pc
AC/DC adapter	1 pc
Transmission cable (keyboard signal)	1 pc
Software and USB cable	1 set

OPTIONAL ACCESSORY

Printer	ISF-DF-PRINTER
RS232 cable	IST-DTT-CABLE
Wireless transmitter (receiver is needed)	7315-ISF-D

DIGITAL BOTTLE CAP TORQUE TESTERS



DATA
OUTPUT

two display modes

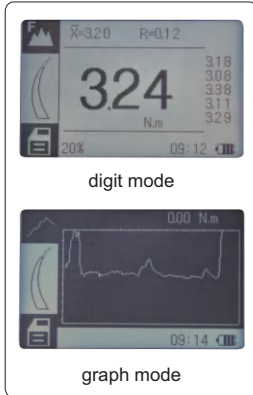

IST-DCT20



printer (optional)

- Measure the opening and tightening torque of bottle caps
- Unit: N.m, N.cm, kgf.cm, lbf.in, lbf.ft
- Clockwise and counter-clockwise operation
- Upper and lower tolerance limits can be set to determine pass or fail
- LCD display with backlight
- With calibration function
- Overload alarm
- Maximum overload of 120% of range
- Automatic power off

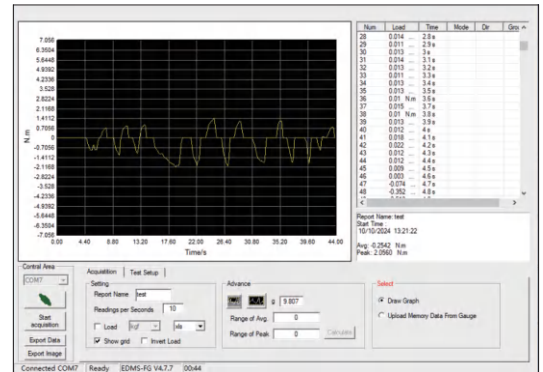

software (included)

SPECIFICATION

Code	IST-DCT2	IST-DCT5	IST-DCT10	IST-DCT20
Load capacity	2N.m	5N.m	10N.m	20N.m
Resolution	0.0002N.m	0.0005N.m	0.001N.m	0.002N.m
Clamping range	Ø19.5~190mm			
Sampling frequency	2000Hz			
Accuracy	±0.3% (of load capacity)			
Measuring mode	tracking, peak (max.), first peak, double peak, tolerance testing			
Output	USB, RS232			
Number of memory	1000 memories			
Power supply	built-in rechargeable battery			
Dimension	200×197×150mm			
Weight	2.5kg			

STANDARD DELIVERY

Main unit	1 pc
AC/DC adapter	1 pc
Transmission cable (keyboard signal)	1 pc
Measuring software	1 set

OPTIONAL ACCESSORY

Printer	ISH-DS-PRINTER
Wireless transmitter (receiver is needed)	7315-ISF-D

TORQUE TESTERS

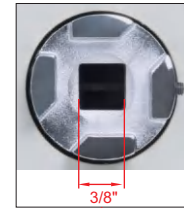
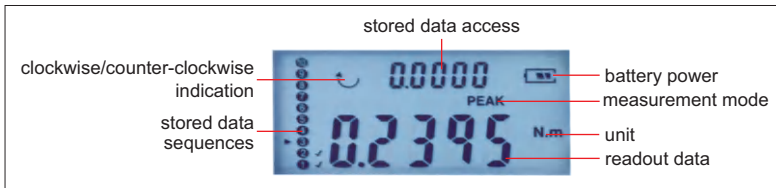

IST-HP1

- For testing electric, pneumatic and manual torque screwdrivers and torque wrenches and other torque tools
- Clockwise and counter-clockwise operation
- Peak and track working modes
- High-definition display, backlighting available
- High sampling frequency for accurate peak capture
- Unit: N.m, lb.in, kgf.cm
- Upper and lower limits can be set, automatic audible and visual alarm with red and green indicator lights and buzzer
- Store 10 sets of data and calculate the average value
- Serial RS232 output, connect to PC to view torque curves by test software
- Automatic zero setting, automatic shutdown

software (included)

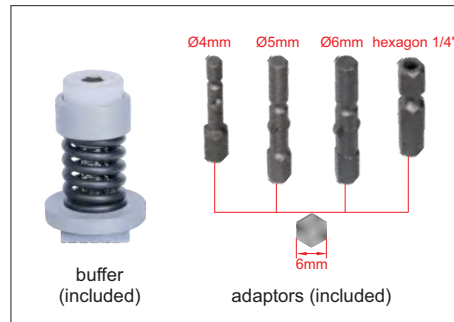
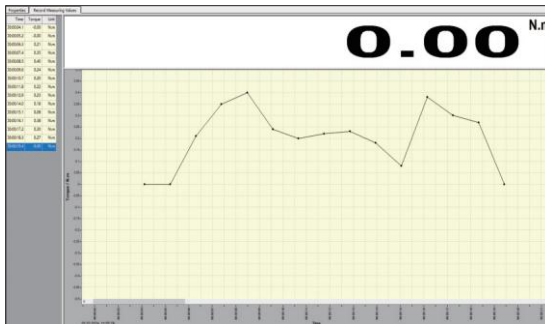

SPECIFICATION

Code	IST-HP1	IST-HP2	IST-HP5	IST-HP10	IST-HP20
Maximum range	1N.m	2N.m	5N.m	10N.m	20N.m
Resolution	0.0005N.m	0.001N.m	0.002N.m	0.005N.m	0.01N.m
Accuracy	±1%				
Maximum test speed	3000rpm				
Number of memory	10 groups				
Power supply	built-in rechargeable battery, can be used for 40 hours				
Dimension	230×110×50mm				
Weight	2.4kg				

STANDARD DELIVERY

Main unit	1 pc
Buffer	1 pc
Adaptor	4 pcs
Power adapter	1 pc
Software and RS232 cable	1 pc

ATTENTION: NOT SUITABLE FOR HIGH SPEED SHOCK TORQUE MEASUREMENT

DIGITAL TORQUE TESTERS



adaptor
(type A included)

IST-04TT350
type A

IST-04TT815
type B

- Test torque wrenches, torque screwdrivers and other torque tools
- Clockwise operation
- Peak, track and first peak working modes
- Tolerance testing
- LED indicator for target torque alarm:
 - Green LED light on when the value is within tolerance;
 - Red LED light on when the value is above the high tolerance
- Ability to upload data in real time, save data and export data to EXCEL
- Power off automatically in 2 minutes without any operations

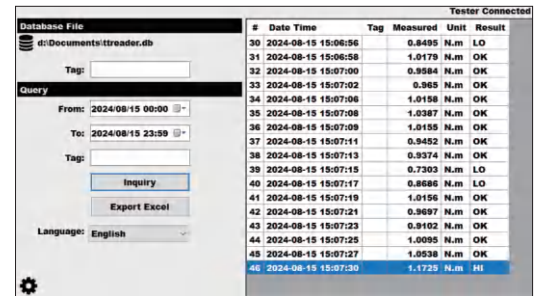

software (included)

SPECIFICATION

Code	IST-04TT5	IST-04TT28	IST-04TT68	IST-04TT350	IST-04TT815	IST-04TT1000	IST-04TT2000
Type	A				B		
Range	0.5~5N.m	2.8~28N.m	6.8~68N.m	35~350N.m	81.5~815N.m	100~1000N.m	200~2000N.m
Accuracy	±1% (clockwise)						
Resolution	0.001N.m	0.01N.m	0.01N.m	0.1N.m	0.1N.m	1N.m	1N.m
Unit	N.m, in.lb, ft.lb, kg.cm				N.m, ft.lb		
Square socket/hex driver	1/4"	3/8"	3/8"	1/2"	27mm	27mm	27mm
Adaptor	no	3/8" to 1/4"	3/8" to 1/4"	1/2" to 3/8" 3/8" to 1/4"	no		
Power supply	AC 100~240V, 50/60Hz						
Weight	0.75kg	0.75kg	1.1kg	1.1kg	5.1kg	5.1kg	5.1kg

STANDARD DELIVERY

Main unit	1 pc
Software and transmission cable	1 pc
AC/DC adapter	1 pc
Adaptor	refer to details

DIGITAL TORQUE TESTERS



ATTENTION: NOT SUITABLE FOR HIGH SPEED SHOCK TORQUE MEASUREMENT



IST-TT550



extension cable (included)



adaptor (included)



with 3 mounting holes on the bottom

- With external sensor, to test torque wrenches, torque screwdrivers and other torque tools
- Clockwise and counter-clockwise operation
- Peak, track and first peak working modes
- Tolerance testing
- LED indicator for target torque alarm:
 - Yellow LED light on when the value is below the low tolerance;
 - green LED light on when the value is within tolerance;
 - red LED light on when the value is above the high tolerance
 - The buzzer alarms when the maximum torque value is captured in the first peak mode
- Ability to upload data in real time, save data and export data to EXCEL
- Automatic power off

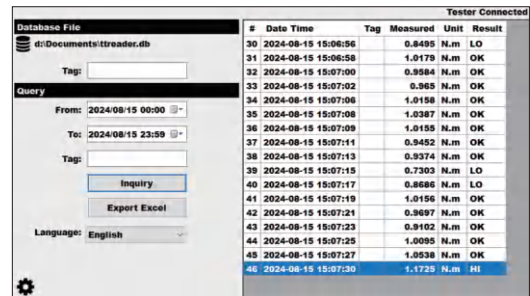

software (included)

SPECIFICATION

Code	IST-TT05	IST-TT5	IST-TT30	IST-TT50	IST-TT220	IST-TT550	IST-TT1000	IST-TT2200	IST-TT3000
Range	0.1~0.5N.m	0.5~5N.m	3~30N.m	5~50N.m	22~220N.m	55~550N.m	100~1000N.m	220~2200N.m	300~3000N.m
Accuracy	±1% (two-way)	±0.5% (two-way)							
Resolution	0.0001N.m	0.0001N.m	0.001N.m	0.001N.m	0.01N.m	0.01N.m	0.1N.m	0.1N.m	0.1N.m
Unit	in.lb, ft.lb, kg.cm, N.m						N.m, ft.lb		
Square socket (L)	1/4"	1/4"	3/8"	3/8"	1/2"	3/4"	1"	1"	1"
Power supply	AC 100~240V, 50/60Hz								
Adaptor	no	no	3/8" to 1/4"	3/8" to 1/4"	1/2" to 3/8" 3/8" to 1/4"	3/4" to 1/2" 1/2" to 3/8"	1" to 3/4" 3/4" to 1/2" 1/2" to 3/8"	1" to 3/4" 3/4" to 1/2"	1" to 3/4" 3/4" to 1/2"
Transducer dimension	63×63 ×65mm	63×63 ×65mm	89×89 ×75mm	89×89 ×75mm	109×109 ×83mm	140×140 ×107mm	160×160 ×126mm	160×160 ×126mm	160×160 ×126mm
Weight	0.75kg	0.75kg	1.1kg	1.1kg	1.4kg	2.9kg	5.0kg	5.1kg	5.2kg

STANDARD DELIVERY

Main unit	1 pc
Transducer with 1.5m cable	1 pc
Software and transmission cable	1 pc
Extension cable (1.2m)	1 pc
AC/DC adapter	1 pc
Adaptor	refer to details



TORQUE WRENCH TEST STANDS



IST-06TS350

digital torque tester (optional)



application example



- Rotate the wheel to apply force, rotary speed is adjustable
- Easy operation due to the gear box
- Used with digital torque testers (IST-TT series)

SPECIFICATION

Code	IST-06TS350	IST-06TS1100	IST-06TS2000
Max. torque value	350N.m	1100N.m	2000N.m
Arm length	197~686mm	380~1350mm	420~1690mm
Dimension	860×290×590mm	1760×350×590mm	2090×350×590mm
Weight	32.5kg	76kg	80kg

Can be customized according to test requirements

OPTIONAL ACCESSORY

Digital torque tester	IST-TT series
Adaptor	IST-06TS-BLOCK1 (necessary for IST-TT05, IST-TT5, IST-TT30, IST-TT50 and IST-TT220)
	IST-06TS-BLOCK2 (necessary for IST-TT550, IST-TT1000 and IST-TT2200)

SEMI-AUTOMATIC TORQUE WRENCH TEST STAND CODE IST-07TS3000



control buttons for motorized load

support plate

slide

IST-07TS3000

- Motorized load (constant speed of applied torque): maximum torque up to 1000N.m for testing torque wrenches and reducing test time
- Manual load (adjustable speed of applied torque): maximum torque up to 3000N.m for testing torque wrenches
- Easy operation due to the gear box
- The slide can be moved to adjust different length of torque wrenches and the support plate can be adjusted to keep the wrench level
- Used with digital torque testers **IST-TT series (optional)**

32

application example

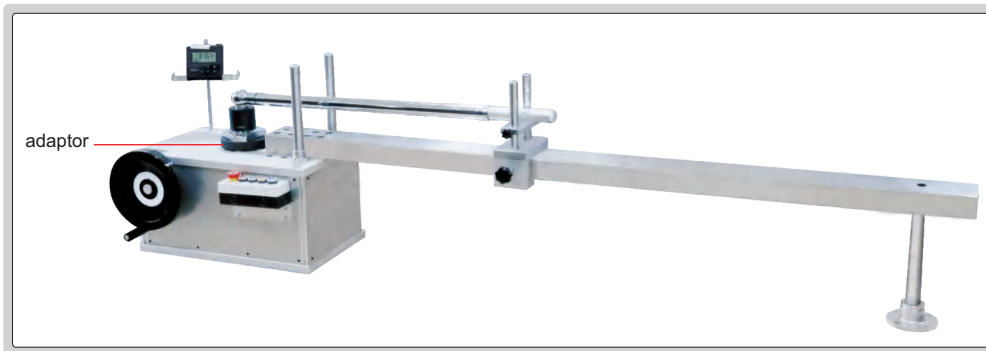

adaptor

SPECIFICATION

Max. torque value (manual load)	3000N.m
Arm length	420~2050mm
Power supply	220V, 50Hz
Dimension	2400×480×630mm
Weight	135kg

Can be customized according to test requirements

digital torque tester (optional)



OPTIONAL ACCESSORY

Digital torque tester	IST-TT550, IST-TT1000, IST-TT2200, IST-TT3000
Adaptor	IST-07TS-BLOCK (necessary for IST-TT550, IST-TT1000, IST-TT2200 and IST-TT3000)

ATTENTION: NOT SUITABLE FOR HIGH SPEED SHOCK TORQUE MEASUREMENT

DYNAMIC TORQUE SENSORS (COMPACT TYPE)



IST-IR100

- Wide range of applications, for testing electric, pneumatic and manual torque screwdrivers and torque wrenches and other torque tools and torque monitoring
- Clockwise and counter-clockwise operation
- High overall accuracy, good long-term stability

SPECIFICATION

RPM range	≤3000rpm
Torque signal	<2.0mV/V
Zero output	±0.5%F.S
Accuracy	0.1%F.S.
Hysteresis	0.5%F.S.
Repeatability	0.1%F.S.
Creep (30 minutes)	0.05%F.S
Temperature sensitivity drift	0.05%F.S./10°C
Zero temperature drift	0.05%F.S./10°C
Response time	1.0ms (50% response)
Response frequency	1kHz
Max. torsion angle	2.6×10rad (0.149°)
Inertial torque	0.38kg.cm
Intrinsic frequency of rotor vibration	19.4kHz
Torque constant	3.85×10N.m/rad
Material	stainless steel
Annual stability	0.3%/year
load resistance	>2kΩ
Power supply	DC5~15V
Working environment	-10~50°C ≤85%RH
Safety overload	150%
Extreme overload	200%
Cable specification	Ø5mm×3m
Extreme cable pulling force	10kg

example of torque test



example of torque monitoring

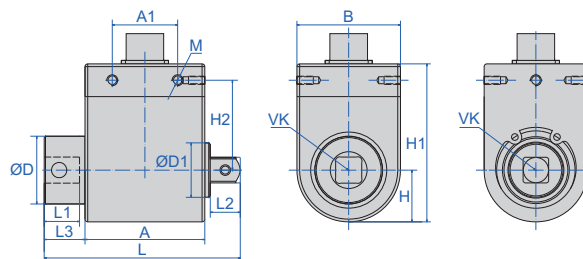
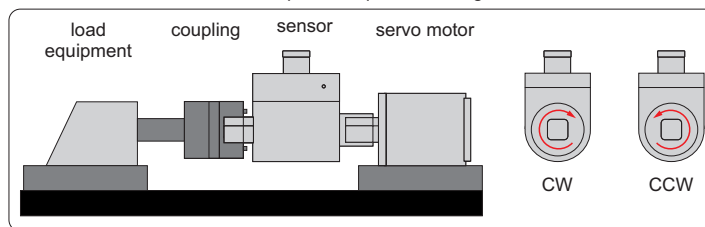

(mm)

Code	Maximum range	VK	A	B	L	L1	L2	L3	H	H1	H2	A1	ØD	ØD1	M
IST-IR10	10N.m	3/8"	44	38	72	13	11	15	19	58	33	24	25	20	5-M4 depth 8
IST-IR20	20N.m														
IST-IR30	30N.m														
IST-IR50	50N.m	1/2"	44	38	80	17	15	19	19	58	33	24	25	20	5-M4 depth 8
IST-IR100	100N.m														
IST-IR200	200N.m														

STANDARD DELIVERY

Torque sensor (with connecting cable)	1 pc
---------------------------------------	------

OPTIONAL ACCESSORY

Handheld force/torque indicator	ISF-DG4
---------------------------------	---------

DYNAMIC TORQUE SENSORS

- Real-time display of torque, RPM and power values
- Support RS485 communication, support active uploading protocols
- Communication rate up to 1000 Hz
- Torque signal is $\pm 5V$ transformed voltage output
- OLED display, resolution 128*64
- Simple calibration, zeroing, filtering, etc. can be performed

SPECIFICATION

RPM signal	120/60/10 pulses/rev.
Zero output	$\pm 0.1\%$ F.S.
Accuracy	0.1%F.S.
Hysteresis	0.5%F.S.
Repeatability	0.1%F.S.
Creep (30 minutes)	0.05%F.S.
Temperature sensitivity drift	0.05%F.S./10°C
Zero temperature drift	0.05%F.S./10°C
Response time	0.6ms (50% response)
Response frequency	1kHz
Max. torsion angle	$2.6 \times 10 \text{ rad}$ (0.149°)
Inertial torque	0.38kg.cm
Intrinsic frequency of rotor vibration	19.4kHz
Torque constant	$3.85 \times 10 \text{ N.m/rad}$
Material	stainless steel
Annual stability	0.3%/year
load resistance	>2k Ω
Power supply	DC24V 0.2A
Working environment	-10~50°C, $\leq 85\%$ RH
Safety overload	150%
Extreme overload	200%
Cable specification	$\varnothing 5\text{mm} \times 3\text{m}$
Extreme cable pulling force	10kg

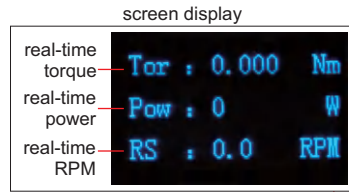

ATTENTION: CUSTOMIZATION IS REQUIRED FOR RPM EXCEEDING THE RATED RPM

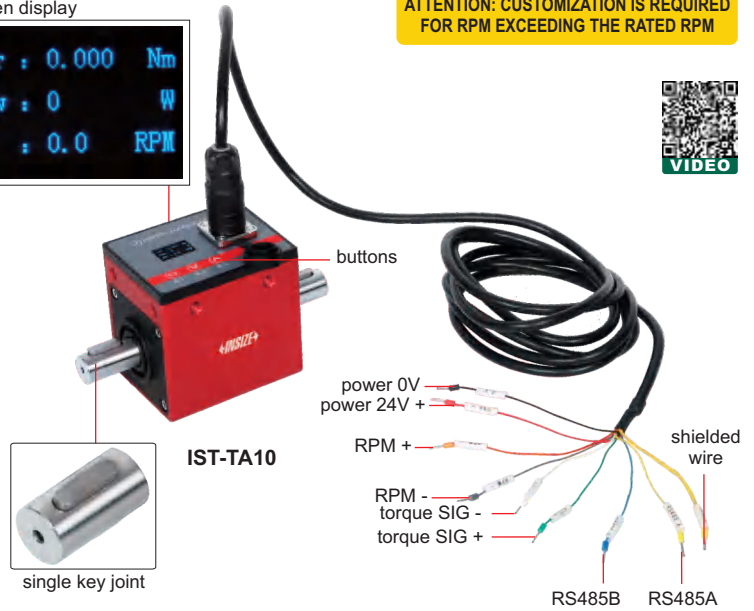

example of sensor usage

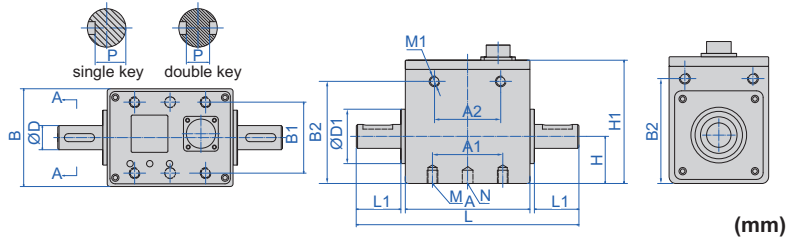
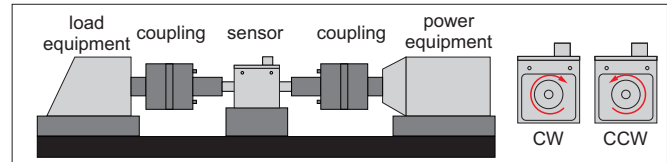

(mm)

Code	Maximum range	Rated RPM	ØD	B	L	L1	H	H1	A1	A2	B1	B2	ØD1	M	M1	N	Key size (L×W)	P
IST-TA1S	1N.m	8000rpm	10	51	108	18	25.5	68	58	/	43	/	12	4-M3 depth 6	/	/	single key 15×3	8.2
IST-TA2S	2N.m																	
IST-TA3S	3N.m																	
IST-TA5S	5N.m																	
IST-TA1L	1N.m	8000rpm	10	73	148	23.6	35.5	93	53	50	53	77	41	4-M8 depth 10	8-M8 depth 6	2-Ø8 depth 10	single key 10×3	8.2
IST-TA2L	2N.m																	
IST-TA3L	3N.m																	
IST-TA5L	5N.m																	
IST-TA10	10N.m	8000rpm	18	73	168	33.6	35.5	93	53	50	53	77	41	4-M8 depth 10	8-M8 depth 6	2-Ø8 depth 10	single key 22×6	14.5
IST-TA20	20N.m																	
IST-TA30	30N.m																	
IST-TA50	50N.m																	
IST-TA100	100N.m	7000rpm	28	73	208	53.5	35.5	93	53	50	53	77	51	4-M8 depth 10	8-M8 depth 6	2-Ø8 depth 10	single key 28×8	24
IST-TA200	200N.m																	
IST-TA300	300N.m																	
IST-TA500	500N.m																	
IST-TA800	800N.m	6000rpm	38	90	238	65.5	44	107.5	60	60	60	91	61	4-M8 depth 12	8-M8 depth 12	2-Ø8 depth 10	double key 45×10	28
IST-TA1000	1000N.m																	
IST-TA2000	2000N.m																	
IST-TA3000	3000N.m																	
IST-TA5000	5000N.m	4000rpm	60	120	258	75.5	60	138.5	60	70	75	122.5	93	4-M10 depth 15	8-M8 depth 15	2-Ø10 depth 15	double key 60×18	46
IST-TA10000	10000N.m																	
IST-TA20000	20000N.m																	
IST-TA30000	30000N.m																	
IST-TA100000	100000N.m	3000rpm	98	160	356	100.5	80	191.6	80	80	120	157	129	4-M12 depth 25	4-M12 depth 25	/	double key 90×28	78
IST-TA200000	200000N.m																	

application

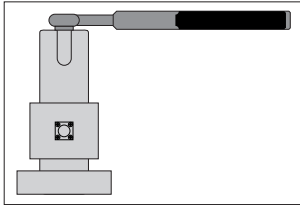

STATIC TORQUE SENSORS

- Wide range of applications: for testing electric, pneumatic and manual torque screwdrivers and torque wrenches and other torque tools and torque monitoring
- Clockwise and counter-clockwise operation
- High overall accuracy, good long-term stability

SPECIFICATION

Output sensitivity	1.0~2.0mV/V
Zero output	±1%F.S.
Linearity	±0.1%F.S.
Hysteresis	±0.5%F.S.
Repeatability	±0.3%F.S.
Creep (30 minutes)	±0.1%F.S.
Temperature sensitivity drift	±0.1%F.S./10°C
Zero temperature drift	±0.1%F.S./10°C
Response frequency	10kHz
Material	alloy steel / stainless steel
Electrical impedance	350±5/700±5Ω
Insulation impedance	≥5000MΩ/100VDC
Operation voltage	5~15V
Working temperature	-20~80°C
Safety overload	120%
Extreme overload	150%
Cable specification	Ø5mm×3m
Extreme cable pulling force	10kg

STANDARD DELIVERY

Torque sensor (with connecting cable)	1 pc
---------------------------------------	------

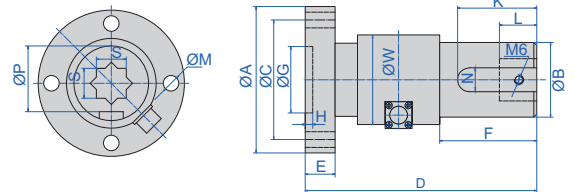

OPTIONAL ACCESSORY

Handheld force/ torque Indicators	ISF-DG series
-----------------------------------	---------------

(mm)

Code	Maximum range	ØA	ØB	ØC	ØW	D	E	F	K	L	N	S	ØP	ØM	ØG	H
IST-NJ10S	10N.m	98	50	80	58	90	15	33	33	25	16	20	44	4×Ø10.5 (4×Ø6 is optional)	/	/
IST-NJ20S	20N.m															
IST-NJ30S	30N.m															
IST-NJ50S	50N.m															
IST-NJ100S	100N.m															
IST-NJ200S	200N.m															
IST-NJ300S	300N.m															
IST-NJ500S	500N.m															
IST-NJ1000S	1000N.m															
IST-NJ10L	10N.m															
IST-NJ20L	20N.m															
IST-NJ30L	30N.m															
IST-NJ50L	50N.m															
IST-NJ100L	100N.m															
IST-NJ200L	200N.m															
IST-NJ300L	300N.m															
IST-NJ500L	500N.m															
IST-NJ1000L	1000N.m															
IST-NJ2000	2000N.m	125	75	105	83	150	20	65	60	30	20	25.5	67.5	8×Ø12	60	6
IST-NJ3000	3000N.m											40.5				
IST-NJ5000	5000N.m											40.5				

HANDHELD FORCE/TORQUE INDICATORS



- For use with force sensors and torque sensors
- Three modes of real-time value display, peak value display and valley value display
- Force unit: N, kN, kg, lb, t
- Torque unit: N.m, kg.cm, in.lb, ft.lb
- High sampling rate captures peak value accurately
- Select to display the real-time curve and the last historical curve
- Real-time automatic capture of peak value and valley value
- Parameter backup and restoration, even if the parameters are messed up, you can restore them with a single click
- Weightless calibration, just enter the sensor parameters and you are ready for calibration
- A variety of alarm options: upper limit alarm, lower limit alarm, peak and valley alarm, over 1.2 times of the range alarm
- Supply voltage 3.5V, analog signal input range -15~15mV

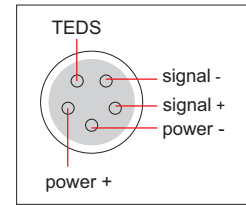

ISF-DG1

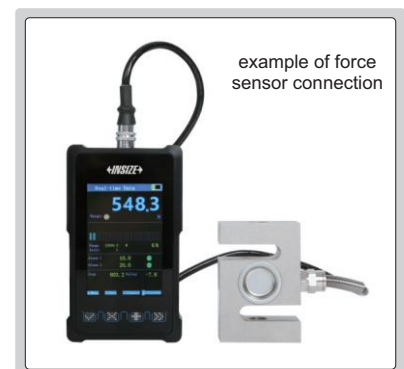
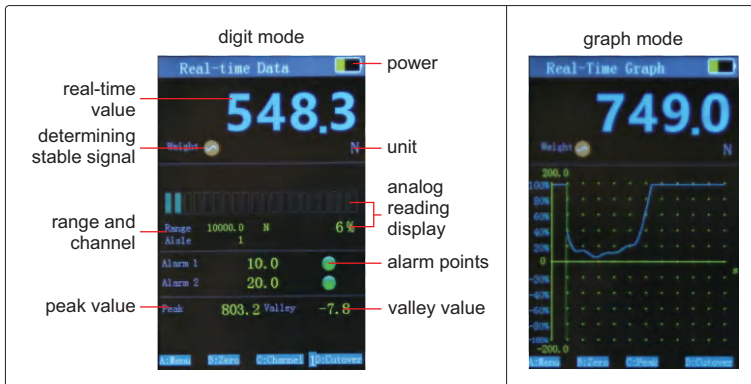

SPECIFICATION

Code	ISF-DG1	ISF-DG2	ISF-DG3	ISF-DG4
Number of channels	7 channels		single channel	
Max. sampling frequency	3200Hz	12800Hz	3200Hz	3200Hz
Type	force+torque		force	torque
Unit switch	switching units requires recalibration		units can be switched in real time	
Accuracy	±0.1% (of load capacity)			
Output	TYPE-C			
Number of memory	200 groups			
Power supply	built-in rechargeable battery, can be used for 15 hours			
Dimension	132×76×20mm			
Weight	300g			

STANDARD DELIVERY

Main unit	1 pc
Power adapter	1 pc



phillips screwdriver bits (included)



hex screwdriver bits (included)

- Clockwise and counter-clockwise operation
- Unit: cN.m, in.lb, kg.cm
- Peak and track working modes
- Target torque value can be set, with audible and visible alarm:
 - Green LED light on and buzzer sounds when target torque value is 90%~100% of target torque
 - Red LED light on and buzzer sounds when target torque value is reached
- Power off automatically in 5 minutes without any operations

DIGITAL TORQUE SCREWDRIVERS

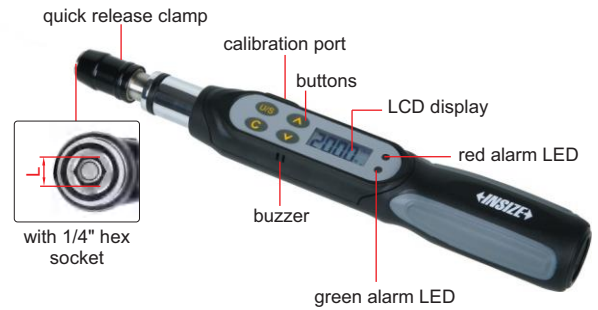

IST-SD200

SPECIFICATION

Code	IST-SD50	IST-SD200	IST-SD400
Range	10~50cN.m	40~200cN.m	80~400cN.m
Accuracy	clockwise	±2.5%	±2.5%
	counter-clockwise	±4%	±3.5%
Resolution	0.1cN.m	0.1cN.m	0.1cN.m
Size of hex socket (L)	1/4"	1/4"	1/4"
Power supply	1×AAA battery		
Length	193mm	203mm	203mm
Weight	190g	200g	200g

STANDARD DELIVERY

Torque screwdriver	1 pc
Phillips screwdriver bits	1 pc
Hex screwdriver bits	1 pc

OPTIONAL ACCESSORY

Calibration cable	IST-SD-CABLE
-------------------	--------------



BUILT-IN BLUETOOTH



BLUETOOTH DIGITAL TORQUE SCREWDRIVERS (KEYBOARD SIGNAL)



IST-3SD200



phillips screwdriver bits (included)



hex screwdriver bits (included)

Torque screwdrivers:

- Clockwise and counter-clockwise operation
- Unit: cN.m, in.lb, kg.cm
- Peak and track working modes
- Target torque value can be set, with audible and visible alarm:
 - Green LED light on and buzzer sounds when target torque value is 90%~100% of target torque
 - Red and green LED lights on and buzzer sounds when target torque value is reached
- Auto power off

Data transmission:

- Built-in Bluetooth module, which can be connected with computers (with Bluetooth function), mobile phones, tablets and other devices
- Keyboard signal, can be transmitted to Excel
- Transmission distance is 10 meters (no obstacles, no electromagnetic interference)
- Bluetooth connection and disconnection are respectively shown by indicator lights

SPECIFICATION

Code	IST-3SD50	IST-3SD200	IST-3SD400	IST-3SD600
Range	10~50cN.m	40~200cN.m	80~400cN.m	120~600cN.m
Accuracy	clockwise	±2%		
	counter-clockwise	±3%		
Resolution	0.1cN.m			
Size of hex socket (L)	1/4"			
Power supply	1×3.7V replaceable lithium battery			
Length	203mm			
Weight	190g			

STANDARD DELIVERY

Torque screwdriver	1 pc
Phillips screwdriver bits	1 pc
Hex screwdriver bits	1 pc

OPTIONAL ACCESSORY

Calibration cable	IST-SD-CABLE
-------------------	--------------

WIRED TRANSMISSION DIGITAL TORQUE SCREWDRIVERS (KEYBOARD SIGNAL)

DATA TRANSMISSION

INSPECTION CERTIFICATE



phillips screwdriver bits (included)



hex screwdriver bits (included)

Torque screwdrivers:

- Clockwise and counter-clockwise operation
- Unit: cN.m, in.lb, kg.cm
- Peak and track working modes
- Target torque value can be set, with audible and visible alarm:
 - Green LED light on and buzzer sounds when target torque value is 90%~100% of target torque
 - Red and green LED lights on and buzzer sounds when target torque value is reached
- Auto power off

Data transmission:

- Keyboard signal through a cable, can be transmitted to Excel, Word, Txt, etc.



IST-2SD200

SPECIFICATION

Code	IST-2SD50	IST-2SD200	IST-2SD400	IST-2SD600
Range	10~50cN.m	40~200cN.m	80~400cN.m	120~600cN.m
Accuracy	clockwise	±2%		
	counter-clockwise	±3%		
Resolution	0.1cN.m			
Size of hex socket (L)	1/4"			
Power supply	1×3.7V replaceable lithium battery			
Length	203mm			
Weight	190g			

STANDARD DELIVERY

Torque screwdriver	1 pc
Phillips screwdriver bits	1 pc
Hex screwdriver bits	1 pc

OPTIONAL ACCESSORY

Calibration cable	IST-SD-CABLE
Transmission cable	IST-HID-CABLE

TORQUE SCREWDRIVERS

ATTENTION: CLOCKWISE OPERATION ONLY

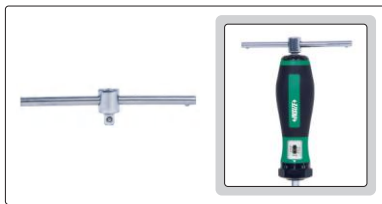

T-bar wrench (for IST-MG250, IST-MG360, IST-MG600)



IST-MG100

SPECIFICATION

Code	IST-MG100	IST-MG250	IST-MG360	IST-MG600
Range (clockwise)	20~100cN.m	50~250cN.m	60~360cN.m	1.0~6.0N.m
Graduation	2cN.m	5cN.m	5cN.m	0.1N.m
Head	1/4" hex socket			
Accuracy	±6%			
Length	172mm			
Weight	0.26kg			

STANDARD DELIVERY

Torque screwdriver	1 pc
T-bar wrench (for IST-MG250, IST-MG360, IST-MG600)	1 pc

ATTENTION: TORQUE TESTERS ARE NEEDED FOR CALIBRATION

INTELLIGENT ELECTRIC SCREWDRIVERS (CURRENT CONTROL)

ATTENTION: SPEED SHOULD BE BELOW 100RPM WHEN TIGHTENING IS ENDED



HES-E152



HES-E403



HES-E901A



controller type A



controller type B

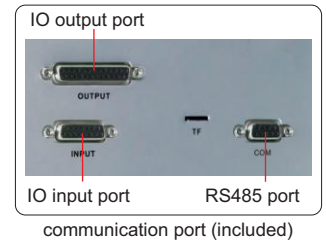

- Highly efficient heat dissipation setting, ultra-low noise handling
- Permanent magnet synchronous servo motor and high-precision reducer power transmission mechanism
- High-precision angle sensor (resolution 1°) and two-color LED indication of locking status
- The safety level conforms to the relevant provisions of GB3883/IEC60745 and other standards
- 12 task modes, each task can be configured with 8 different torque parameters
- Locked data is stored in EXCEL on the hard disk for 600 days
- Built-in servo drive for precise control of torque, angle and speed
- Provide graphical tool for process optimization and diagnostic
- Provide programmable IO and RS485 communication port for process control and data transmission
- Physical buttons for assisted operation and they are monitored by LED lights



balance arm (optional)

controller (included)

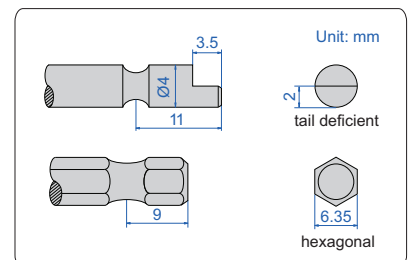
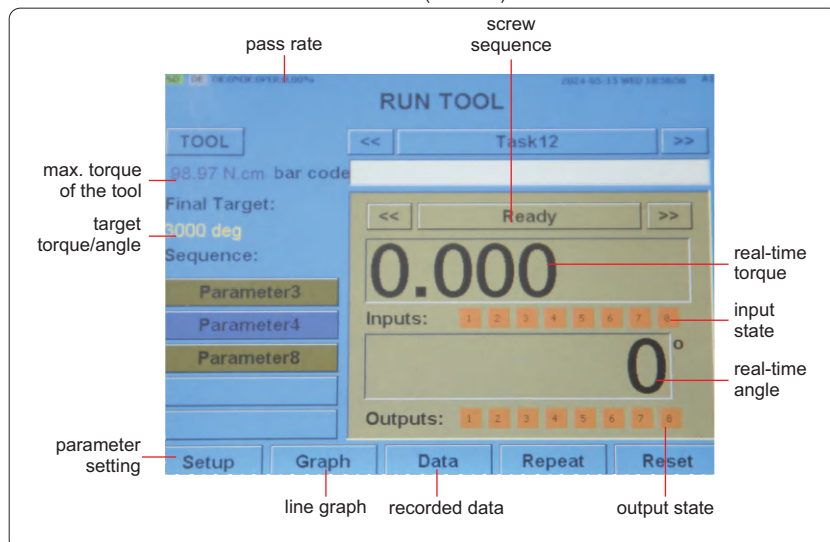

screwdriver head (optional)
(can be customized: cross, flathead, hexagonal, star-shaped)

To be continued

Continued from previous page

interface of tightening parameter setting

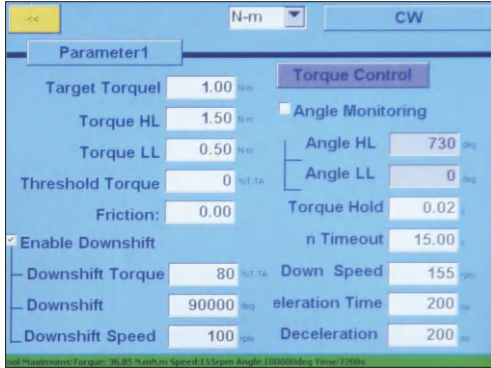

interface of screw sequence matching parameters

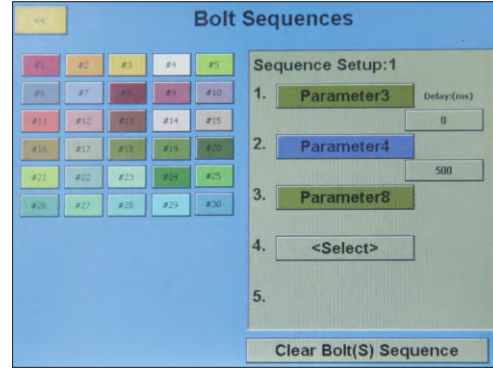

SPECIFICATION

Code	HES-E151	HES-E152	HES-E401	HES-E402	HES-E403	HES-E404
Torque range	0.01~0.13N.m	0.06~0.55N.m	0.02~0.23N.m	0.15~0.90N.m	0.20~1.20N.m	0.50~1.60N.m
Motor power	DC15W		DC40W			
Max. speed	5000rpm	1200rpm	5000rpm	1200rpm	1000rpm	800rpm
Applicable screw outside diameter	1.0~1.7mm	1.4~2.5mm	1.0~2.0mm	2.0~3.0mm	2.0~3.5mm	2.5~4.0mm
Applicable screwdriver head	Ø4mm tail deficient				6.35mm hexagonal	
Controller	type A					
Power supply	AC 85~264V, 47~63Hz					
Display operation interface	touch screen menu operation mode, 3 function buttons+3 LED indicators					
Torque accuracy	±5% at 30%~80% of maximum output torque, ±8% in other range					
Dimension	electric screwdriver	242×53×35mm	214×64.4×38mm	231×64.4×38mm		
	controller	151.5×185.8×221mm				
Weight	electric screwdriver	300g	400g	500g	600g	
	controller	3500g				

Code	HES-E901A	HES-E902A	HES-E903A	HES-E901B	HES-E902B	HES-E903B	
Torque range	0.10~0.70N.m	0.60~2.40N.m	0.60~3.00N.m	0.20~1.20N.m	0.80~4.30N.m	1.00~5.50N.m	
Motor power	DC90W			AC90W			
Max. speed	5000rpm	1200rpm	1000rpm	5000rpm	1500rpm	1200rpm	
Applicable screw outside diameter	2.0~2.5mm	3.5~4.5mm	3.5~5.0mm	2.0~3.5mm	3.5~5.5mm	4.0~6.0mm	
Applicable screwdriver head	6.35mm hexagonal						
Controller	type B						
Power supply	AC 200~230V±10%, 50~60Hz						
Display operation interface	touch screen menu operation mode, 3 function buttons+3 LED indicators						
Torque accuracy	±5% at 30%~80% of maximum output torque, ±8% in other range						
Dimension	electric screwdriver	317×59.5×47.5mm			235×160×345mm		
	controller	210×160×345mm			235×160×345mm		
Weight	electric screwdriver	900g	1060g	900g	1060g		
	controller	5500g					

STANDARD DELIVERY

Electric screwdriver	1 pc
Controller	1 pc
Cross screwdriver head	1 pc
Tool connection cable	1 pc
USB transmission cable	1 pc

OPTIONAL ACCESSORY

Ø4mm tail deficient screwdriver head	
6.35mm hexagonal screwdriver head	
Balance arm	HES-E-X*
QR code scanner	HES-E-S

* Not suitable for HES-E151, HES-E152

ATTENTION: TORQUE TESTERS ARE NEEDED TO SET TORQUE

INVERTER BRUSHLESS ELECTRIC SCREWDRIVERS



spring loaded balancer (optional)



cross screwdriver head (included)



- Adopting high performance, low inertia, low loosening, low power consumption, low impact brushless servo motor components, with ultra-long life and durability
- Frequency conversion and constant voltage function for stable torque, temperature and speed, low temperature rise
- Ergonomic design, small size and light weight, wider range torque, can be applied to a variety of screw locking requirements, reduce procurement cost
- The safety and durability of low-voltage frequency conversion and the convenience and stability of high-voltage direct plug-in, more flexible and economical in operation
- No toner spillage design, meets the requirements of the 3C industry and environmental protection

screwdriver head (optional)
(can be customized: cross, flathead, hexagonal, star-shaped)

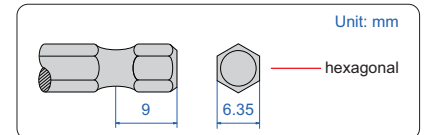

SPECIFICATION

Code	HES-S020	HES-S050	HES-S120	HES-S160	HES-S200	HES-S250	
Torque range	0.03~0.20N.m	0.05~0.50N.m	0.20~1.20N.m	0.20~1.60N.m	0.40~2.00N.m	0.50~2.50N.m	
	0.3~2.0kgf.cm	0.5~5.0kgf.cm	2.0~12.0kgf.cm	2.0~16.0kgf.cm	4.0~20.0kgf.cm	5.0~25.0kgf.cm	
Torque repeatability	5% (at 30%~80% of maximum output torque)						
Rated power	DC60W					DC75W	
Speed range	700~1000rpm	700~1000rpm	1400~2000rpm	700~1000rpm	700~1000rpm	500~750rpm	
Applicable screw outside diameter	mechanical	1.0~2.2mm	1.0~2.6mm	1.4~3.0mm	2.2~4.2mm	2.6~4.5mm	3.0~5.0mm
	self-tapping	1.0~2.0mm	1.0~2.3mm	1.4~2.6mm	2.0~3.2mm	2.3~3.5mm	2.6~4.0mm
Applicable screwdriver head	6.35mm hexagonal						
Power supply	AC100~240V, 50/60Hz						
Electric screwdriver dimension	238×45×40mm						
Electric screwdriver weight	450g						

STANDARD DELIVERY

Electric screwdriver	1 pc
AC adapter	1 pc
Cross screwdriver head	2 pcs

OPTIONAL ACCESSORY

6.35mm hexagonal screwdriver head	
Spring loaded balancer	HES-E-X

DESKTOP AUTOMATIC TIGHTENING MACHINE CODE ATM

CUSTOMIZED ACCORDING
TO WORKPIECES

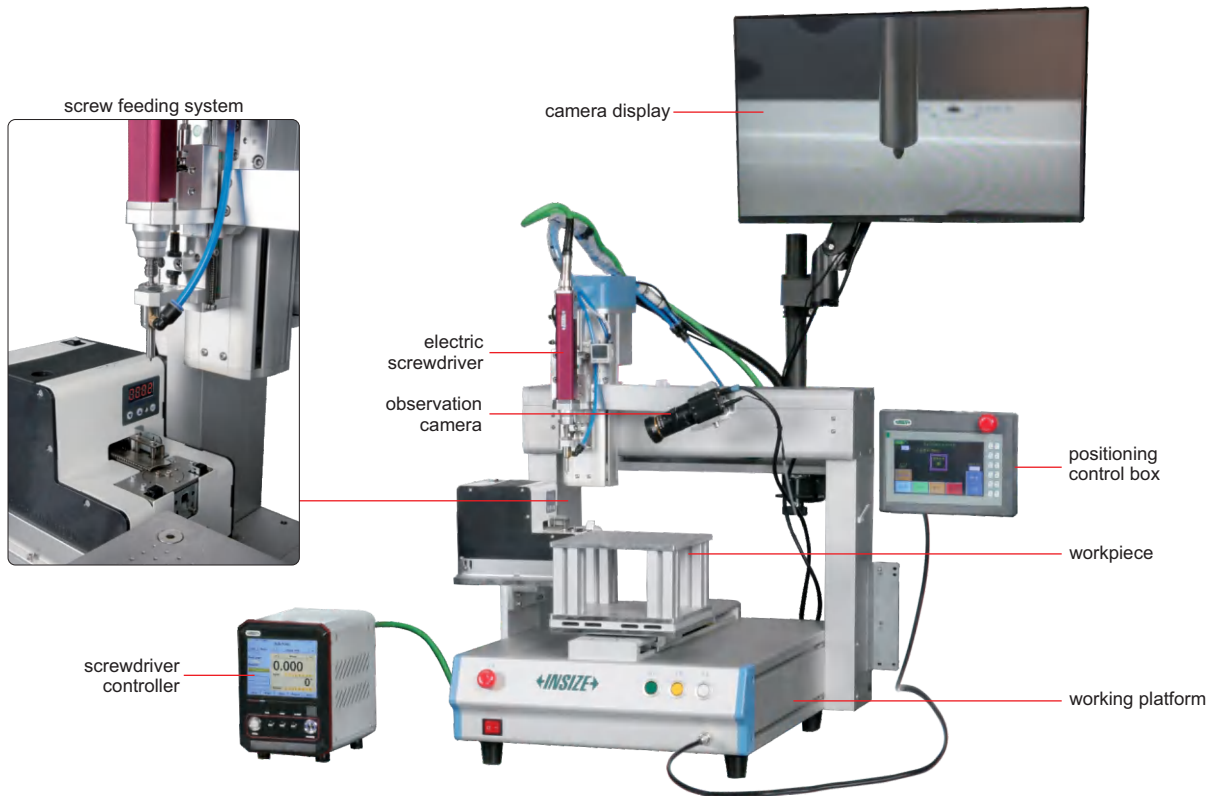

32

SPECIFICATION

Working platform	working direction		vertically down
	max. operation speed	XY-axis	800mm/s
		Z-axis	400mm/s
	max. load	XY-axis	10kg
		Z-axis	5kg
	positioning repeatability		±0.05mm
	control axis		XYZ axis
	number of preset positioning programs		80
number of positioning points for one program		350	
Intelligent electric screwdriver*	number of I/O ports		4 input, 4 output
	applicable torque range		0.01~7.50N.m
	applicable screw outside diameter		1.0~7.0mm
	torque accuracy		±5% at 30%~80% of maximum output torque, ±8% in other range
	resolution of angle		1°
	number of preset tightening programs		12
	number of preset callable parameters		8
number of I/O ports		8 input, 8 output	
Power supply		AC 220V, 50Hz	
Pressure supply		0.5~0.7Mpa	
Environmental requirement		temperature: 0~40°C, relative humidity: 20~85%	

- Working platform is equipped with servo motor for fast working speed and high positioning accuracy
- Intelligent screwdriver with precise control of torque, angle and speed
- Blow or suction automatic screw feeding system is efficient and stable
- Camera-assisted positioning for more convenient and accurate

steps

- Step 1: place the workpiece on positioning fixture and fix it firmly
- Step 2: press the reset button to return the platform and cylinder to the initial position
- Step 3: press the start button, according to the set program to complete tightening of all screws on the workpiece
- Step 4: replace workpiece

STANDARD DELIVERY

Working platform	main unit
	positioning control box
	positioning fixture
Intelligent electric screwdriver	electric screwdriver controller
	suitable screwdriver head
Screw feeding system	1 set
Camera-assisted positioning system	1 set
Control program	1 set

* Intelligent screwdrivers with different torque ranges for different tightening screws



SMALL RANGE DIGITAL TORQUE WRENCHES

- Ratchet head
- Clockwise and counter-clockwise operation
- Unit: N.m, in.lb, ft.lb, kg.cm
- Peak and track working modes
- Target torque value can be set, with audible and visible alarm:
 - Green LED light on and buzzer sounds when target torque value is 90%~100% of target torque
 - Red LED light on and buzzer sounds when target torque value is reached
- Power off automatically in 5 minutes without any operations
- Non-slip grip handle
- With overload record (once the torque reaches 110% of the maximum range)

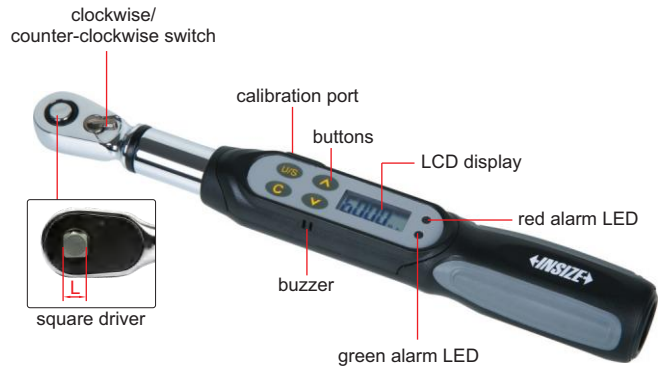

IST-WP6

SPECIFICATION

Code	IST-WP6	IST-WP12	IST-WP20
Range	1.2~6N.m	2.4~12N.m	4~20N.m
Accuracy	clockwise	±3%	
	counter-clockwise	±4%	
Resolution	0.001N.m	0.01N.m	0.01N.m
Square driver (L)	1/4"		
Power supply	1×AAA battery		
Length	260mm		
Weight	430g		

OPTIONAL ACCESSORY

Calibration cable	IST-SD-CABLE
-------------------	--------------



SHORT HANDLE DIGITAL TORQUE WRENCHES

- Ratchet head
- Clockwise and counter-clockwise operation
- Unit: N.m, in.lb, ft.lb, kg.cm
- Peak and track working modes
- Target torque value can be set, with audible and visible alarm:
 - Green LED light on and buzzer sounds when torque value is 90%~100% of target torque
 - Both green and red LED light on and buzzer sounds when target torque value is reached
- Power off in 5 minutes automatically
- Non-slip grip handle
- With damp record
- With overload record (once the torque reaches 110% of the maximum range)



IST-WS60

SPECIFICATION

Code	IST-WS12	IST-WS20	IST-WS30	IST-WS30A	IST-WS60	IST-WS85
Range	2.4~12N.m	4~20N.m	6~30N.m	6~30N.m	12~60N.m	17~85N.m
Accuracy	clockwise	±3%				
	counter-clockwise	±4%				
Resolution	0.01N.m	0.01N.m	0.01N.m	0.01N.m	0.01N.m	0.1N.m
Square driver (L)	1/4"	1/4"	1/4"	3/8"	3/8"	3/8"
Power supply	2×AAA batteries					
Length	215mm	215mm	215mm	215mm	225mm	271mm
Weight	750g	750g	750g	830g	917g	1000g

OPTIONAL ACCESSORY

Calibration cable	IST-SD-CABLE
-------------------	--------------

WIRED TRANSMISSION DIGITAL TORQUE WRENCHES (KEYBOARD SIGNAL)



TYPE B OPTIONAL ACCURACY:
CLOCKWISE: $\pm 1\%$
COUNTER-CLOCKWISE: $\pm 2\%$



**IST-17W12A
type A**

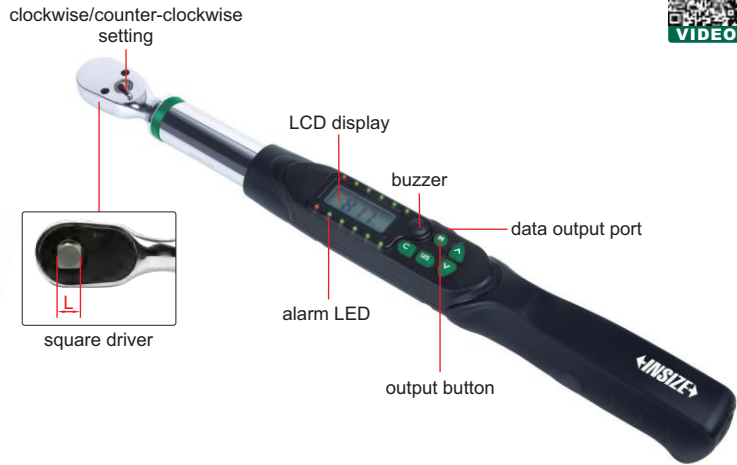

**IST-17W135A
type B**

32

Torque wrench:

- Ratchet head
- Unit: N.m, in.lb, ft.lb, kg.cm
- Clockwise and counter-clockwise operation
- Peak and track working mode
- Can set tolerance with judgement in peak working mode
- 9 target torque values can be set, with audible and visible alarm:
 - Green LED light on and buzzer sounds when torque value is 80%~99.5% of target torque
 - Both green and red LED light on and buzzer sounds when torque value is over 99.5% of target torque
- Power off in 2 minutes automatically
- Non-slip grip handle
- With overload record (once the torque reaches 110% of the maximum range)

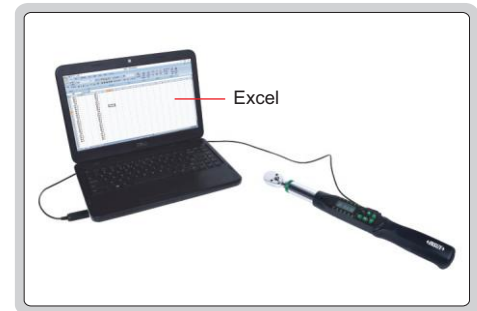

transmission cable (optional)
keyboard signal output via transmission cable

Data transmission:

- Keyboard signal through a cable, can be transmitted to Excel, Word, Txt, etc.
- Press the output button once to output a value

SPECIFICATION

Code	IST-17W06A	IST-17W12A	IST-17W20A	IST-17W30A	IST-17W135A	IST-17W200A	IST-17W340A
Type	type A (short handle)			type B (long handle)			
Range	1.2~6N.m	2.4~12N.m	4~20N.m	6~30N.m	27~135N.m	40~200N.m	68~340N.m
Accuracy	clockwise: $\pm 2\%$						
	counter-clockwise: $\pm 3\%$						
Tolerance setting range	-20%~+20% (target torque value)						
Resolution	0.001N.m	0.01N.m	0.01N.m	0.01N.m	0.1N.m	0.1N.m	0.1N.m
Square driver (L)	1/4"	1/4"	1/4"	1/4"	3/8"	1/2"	1/2"
Power supply	2×AAA batteries			2×AA batteries			
Length	215mm	215mm	215mm	390mm	415mm	530mm	650mm
Weight	750g	750g	750g	760g	940g	1340g	1540g

OPTIONAL ACCESSORY

Calibration cable	IST-SD-CABLE
Transmission cable (keyboard signal)	IST-HID-CABLE *
Transmission cable (serial port signal)	7305-IST *

*Torque wrench must be equipped with an optional transmission cable to enable data transmission

TYPE B OPTIONAL ACCURACY:
CLOCKWISE: $\pm 1\%$
COUNTER-CLOCKWISE: $\pm 2\%$

BUILT-IN BLUETOOTH



BLUETOOTH DIGITAL TORQUE WRENCHES (KEYBOARD SIGNAL)



IST-15W12A
type A

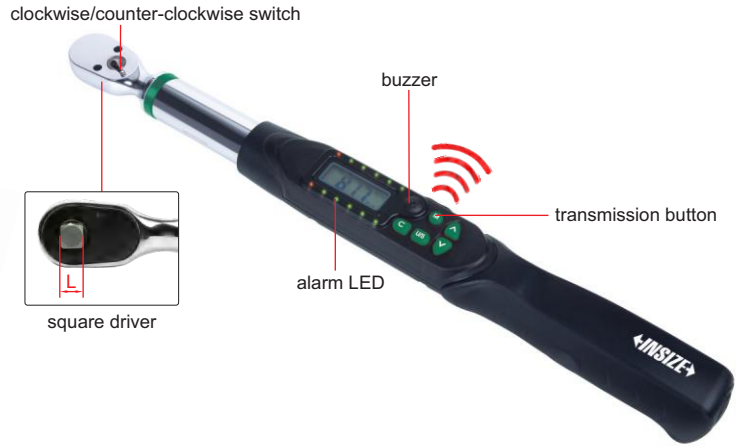

IST-15W135A
type B

Torque wrenches:

- Ratchet head
- Unit: in.lb, ft.lb, N.m, kg.cm
- Clockwise and counter-clockwise operation
- Peak and track working mode
- Can set tolerance with judgement in peak working mode
- 9 target torque values can be set, with audible and visible alarm:
LED lights up in sequence, and the buzzer gets louder and louder when torque value is 80%~99.5% of target torque
- Power off in 2 minutes automatically
- Non-slip grip handle
- With overload record (once the torque reaches 110% of the maximum range)

Data transmission:

- Built-in Bluetooth 4.0 module, which can be connected with computers (with Bluetooth function), mobile phones, tablets and other devices
- Keyboard signal, can be transmitted to Excel, Word, TXT
- Transmission distance is 10 meters (no obstacles, no electromagnetic interference)
- Bluetooth connection and disconnection are respectively shown by indicator lights



transmission distance is 10 meters
(no obstacles, no electromagnetic interference)

SPECIFICATION

Code	IST-15W06A	IST-15W12A	IST-15W20A	IST-15W30A	IST-15W135A	IST-15W200A	IST-15W340A
Type	type A (short handle)			type B (long handle)			
Range	1.2~6N.m	2.4~12N.m	4~20N.m	6~30N.m	27~135N.m	40~200N.m	68~340N.m
Accuracy	clockwise	$\pm 2\%$					
	counter-clockwise	$\pm 3\%$					
Tolerance setting range	-20%~+20% (target torque value)						
Resolution	0.001N.m	0.01N.m	0.01N.m	0.01N.m	0.1N.m	0.1N.m	0.1N.m
Square driver (L)	1/4"	1/4"	1/4"	1/4"	3/8"	1/2"	1/2"
Power supply	2xAAA batteries			2xAA batteries			
Length	215mm	215mm	215mm	390mm	415mm	530mm	650mm
Weight	750g	750g	750g	760g	940g	1340g	1540g

OPTIONAL ACCESSORY

Calibration cable	IST-SD-CABLE
-------------------	--------------

TWO-WAY BLUETOOTH DIGITAL TORQUE WRENCHES



**BUILT-IN
BLUETOOTH**

OPTIONAL ACCURACY:
CLOCKWISE: ±1%
COUNTER-CLOCKWISE: ±2%

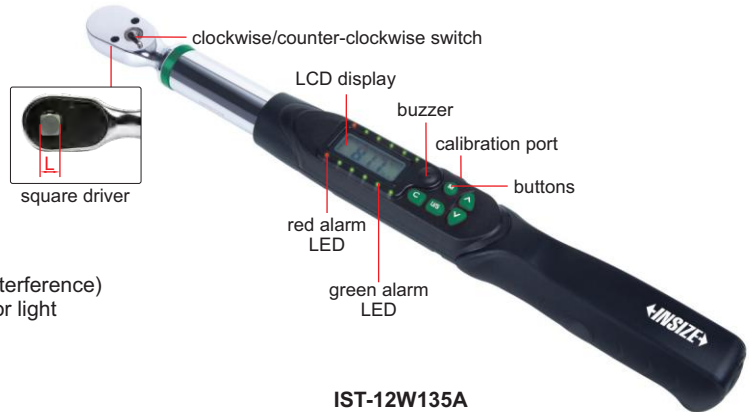

IST-12W135A

Data transmission:

- Data transmission via bluetooth (bluetooth 4.0)
- Two-way transmission and control
- Transmission distance: 10m (no obstacles, no electromagnetic interference)
- Bluetooth connection and disconnection are displayed by indicator light

Torque wrench:

- Ratchet head
- Unit: N.m, in.lb, ft.lb, kg.cm
- Clockwise and counter-clockwise operation
- Peak and track working mode
- Can set tolerance with judgement in peak working mode
- 9 target torque values can be set, with audible and visible alarm:
 - Green LED light on and buzzer sounds when torque value is 80%~99.5% of target torque
 - Both green and red LED light on and buzzer sounds when torque value is over 99.5% of target torque
- Power off in 2 minutes automatically
- Non-slip grip handle
- With overload record (once the torque reaches 110% of the maximum range)

Software:

- In Windows 10 system version 1709 or above
- Two operation mode:
 - Data transmission mode: wrench transmits actual torque value to software after operation
 - Program guidance mode: firstly set process on software (set sequence of tightening, select wrench and set torque values and tolerances). Then software shows which wrench the operator should use (indicator light of the selected wrench is on) and shows the target torque value, and serial number of the screw to be tightened (shows on the wrench); After the operation is finished, the actual torque value is sent to software
- Can select whether the wrench only sends qualified data after operation (in accordance with the tolerance)
- Two data transmission modes: automatic or press button to send
- When the wrench is disconnected, data is stored in the wrench and automatically sent to computer after connection via Bluetooth
- The data in software can be printed or exported to Excel



a computer can be connected with multiple wrenches, the transmission distance is 10 meters (no obstacles, no electromagnetic interference)

SPECIFICATION

Code	IST-12W30A	IST-12W135A	IST-12W200A	IST-12W340A
Range	6~30N.m	27~135N.m	40~200N.m	68~340N.m
Accuracy	clockwise: ±2%			
	counter-clockwise: ±3%			
Tolerance setting range	-20%~+20% (target torque value)			
Resolution	0.01N.m	0.1N.m	0.1N.m	0.1N.m
Square driver (L)	1/4"	3/8"	1/2"	1/2"
Power supply	2xAA batteries			
Length	390mm	415mm	530mm	650mm
Weight	760g	940g	1340g	1540g

OPTIONAL ACCESSORY

Calibration cable	IST-W-CABLE
-------------------	-------------

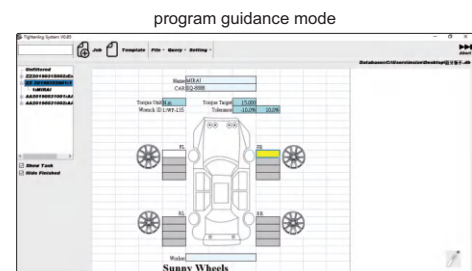
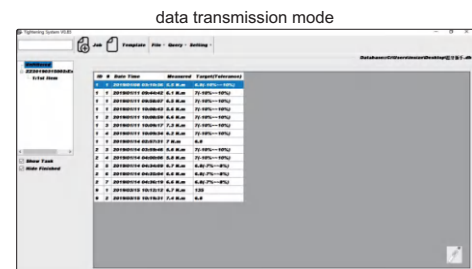

TWO-WAY WIRELESS DIGITAL TORQUE WRENCHES



IST-13W135A



two-way receiver

OPTIONAL ACCURACY:
CLOCKWISE: $\pm 1\%$
COUNTER-CLOCKWISE: $\pm 2\%$

TRANSMISSION DISTANCE
IS 300 METERS

INSPECTION
CERTIFICATE



Torque wrench:

- Ratchet head
- The test results can be transmitted wirelessly to the computer and PLC
- Unit: N.m, in.lb, ft.lb, kg.cm
- Clockwise and counter-clockwise operation
- Peak and track working mode
- Can set tolerance with judgement in peak working mode
- 9 target torque values can be set, with audible and visible alarm:
 - Green LED light on and buzzer sounds when torque value is 80%~99.5% of target torque
 - Both green and red LED light on and buzzer sounds when torque value is over 99.5% of target torque
- Power off in 2 minutes automatically
- Non-slip grip handle
- With damp record
- With overload record (once the torque reaches 110% of the maximum range)

Two-way receiver:

- A two-way receiver can be connected with up to 10 wrenches at the same time, and the maximum transmission distance is 300 meters

Software:

- In Windows10 system version 1709 or above
- Two operation mode:
 - Data transmission mode: wrench transmits actual torque value to software after operation
 - Program guidance mode: firstly set process on software (set sequence of tightening, select wrench and set torque values and tolerances). Then software shows which wrench the operator should use (indicator light of the selected wrench is on) and shows the target torque value, and serial number of the screw to be tightened (shows on the wrench); After the operation is finished, the actual torque value is sent to software.
- Can select whether the wrench only sends qualified data after operation (in accordance with the tolerance)
- Two data transmission modes: automatic or press button to send
- When the wrench is disconnected, data is stored in the wrench and automatically sent to computer after wireless connection
- The data in software can be printed or sent to Excel

TWO-WAY RECEIVER SPECIFICATION

Code	IST-13WREC	IST-13WREC-PLC
Signal output to	computer	PLC
Working frequency	ISM433MHz (432.0~433.8MHz, adjustable)	
Power supply	power adapter, 24V, 0.5A	
Dimension	200×108×31mm	
Weight	500g	

OPTIONAL ACCESSORY

Calibration cable	IST-SD-CABLE
-------------------	--------------

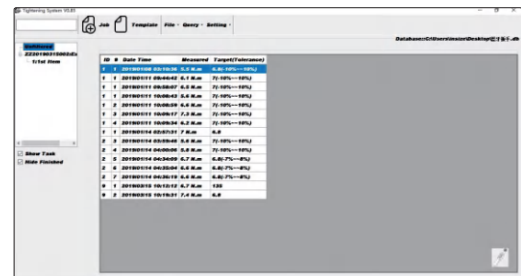

data transmission mode

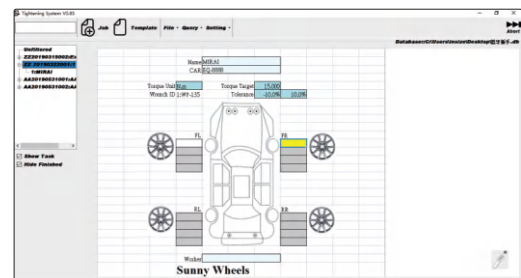

program guidance mode

SPECIFICATION

Code	Range	Accuracy	Unit	Resolution	Square driver (L)	Working frequency	Power supply	Length	Weight
IST-13W30A	6~30N.m	clockwise: $\pm 2\%$ counter-clockwise: $\pm 3\%$	N-m/ft-lb/ in-lb/kg-cm	0.01N.m	1/4"	ISM433MHz (432.0~433.8MHz, adjustable)	2×AA batteries	390mm	760g
IST-13W60A	12~60N.m			0.01N.m	3/8"			390mm	940g
IST-13W135A	27~135N.m			0.1N.m	3/8"			415mm	940g
IST-13W200A	40~200N.m			0.1N.m	1/2"			530mm	1340g
IST-13W340A	68~340N.m	clockwise: $\pm 2.5\%$ counter-clockwise: $\pm 3.5\%$	N-m/ft-lb	0.1N.m	1/2"			650mm	1540g
IST-13W1200A	240~1200N.m			1N.m	1"			1800mm	9000g
IST-13W1500A	300~1500N.m			1N.m	1"			1800mm	9000g
IST-13W2000A	400~2000N.m			1N.m	1"			1800mm	10500g

INTERCHANGEABLE HEAD BLUETOOTH DIGITAL TORQUE WRENCHES (KEYBOARD SIGNAL)

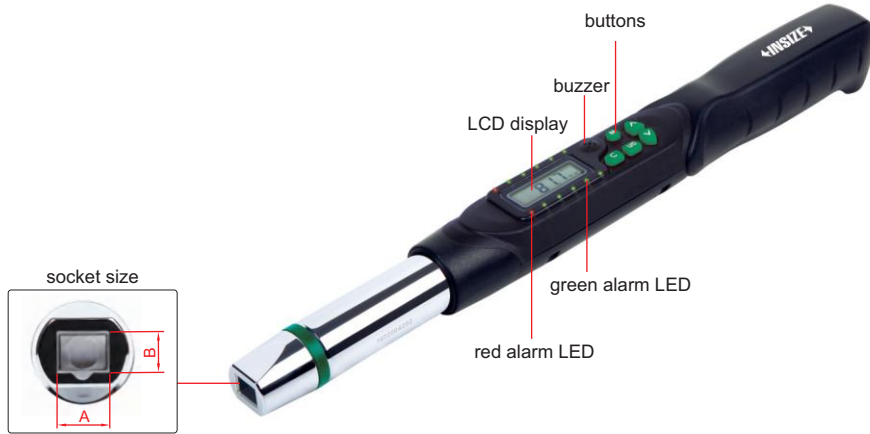

OPTIONAL ACCURACY:
CLOCKWISE: $\pm 1\%$
COUNTER-CLOCKWISE: $\pm 2\%$



IST-18W135A

32

Torque wrenches:

- Unit: N.m, in.lb, ft.lb, kg.cm
- Clockwise and counter-clockwise operation
- Peak and track working modes
- Can set tolerance with judgement in peak working mode
- 9 target torque values can be set, with audible and visible alarm:
 - Green LED light on and buzzer sounds when torque value is 80%~99.5% of target torque
 - Both green and red LED light on and buzzer sounds when torque value is over 99.5% of target torque
- Power off in 2 minutes automatically without any operations
- Non-slip grip handle
- With overload record (once the torque reaches 110% of the maximum range)

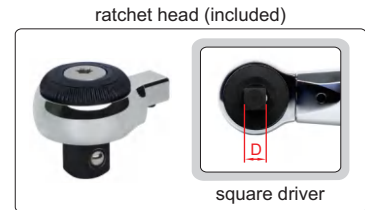

Data transmission:

- Built-in Bluetooth 4.0 module, which can be connected with computers (with Bluetooth function), mobile phones, tablets and other devices
- Keyboard signal, can be transmitted to Excel, Word, TXT
- Transmission distance is 10 meters (no obstacles, no electromagnetic interference)
- Bluetooth connection and disconnection are respectively shown by indicator lights

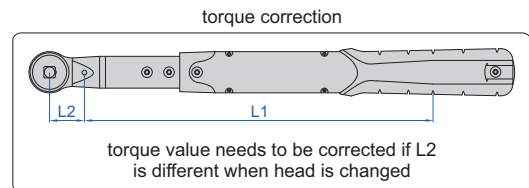

SPECIFICATION

Code	IST-18W30A	IST-18W135A	IST-18W200A	IST-18W340A
Range	6~30N.m	27~135N.m	40~200N.m	68~340N.m
Accuracy	clockwise	$\pm 2\%$		
	counter-clockwise	$\pm 3\%$		
Resolution	0.01N.m	0.1N.m	0.1N.m	0.1N.m
Socket size (A×B)	12×9mm	12×9mm	18×14mm	18×14mm
Arm length (L1)	272.7mm	287.7mm	381.2mm	501.2mm
Power supply	2×AA batteries, for 110 hours working			
Weight	1400g	1570g	2170g	2320g

RATCHET HEAD (INCLUDED) SPECIFICATION

For torque wrench	IST-18W30A	IST-18W135A	IST-18W200A	IST-18W340A
Square driver (D)	1/4"	3/8"	1/2"	1/2"
Length (L2)	29mm	29mm	40mm	40mm

To be continued



Continued from previous page

STANDARD DELIVERY

Torque wrench	1 pc
Ratchet head	1 pc



OPTIONAL ACCESSORY

Calibration cable	IST-W-CABLE
Interchangeable head	refer to details



RATCHET HEAD (optional)

Code	Square driver (D)	Applicable wrenches
IST-2W-R1	1/4"	IST-18W30A
IST-2W-R2	3/8"	IST-18W135A
IST-2W-R3	1/2"	IST-18W135A
IST-2W-R4	1/2"	IST-18W200A IST-18W340A

ADJUSTABLE SPANNER HEAD (optional)

Code	Open size	Applicable wrenches
IST-2W-A1	5~27mm	IST-18W30A IST-18W135A
IST-2W-A2	5-30mm	IST-18W200A
IST-2W-A3	10-41mm	IST-18W340A



OPEN END HEAD (optional)

Code	Open size	Applicable wrenches	
IST-2W-K7	7mm	IST-18W30A IST-18W135A	
IST-2W-K8	8mm		
IST-2W-K9	9mm		
IST-2W-K10	10mm		
IST-2W-K11	11mm		
IST-2W-K12	12mm		
IST-2W-K13	13mm		
IST-2W-K14	14mm		
IST-2W-K15	15mm		
IST-2W-K16	16mm		
IST-2W-K17	17mm		
IST-2W-K18	18mm		
IST-2W-K19	19mm		
IST-2W-K13A	13mm		IST-18W200A IST-18W340A
IST-2W-K14A	14mm		
IST-2W-K15A	15mm		
IST-2W-K16A	16mm		
IST-2W-K17A	17mm		
IST-2W-K18A	18mm		
IST-2W-K19A	19mm		
IST-2W-K21A	21mm		
IST-2W-K22A	22mm		
IST-2W-K24A	24mm		
IST-2W-K27A	27mm		

BOX END HEAD (optional)

Code	Open size	Applicable wrenches	
IST-2W-M7	7mm	IST-18W30A IST-18W135A	
IST-2W-M8	8mm		
IST-2W-M10	10mm		
IST-2W-M11	11mm		
IST-2W-M12	12mm		
IST-2W-M13	13mm		
IST-2W-M14	14mm		
IST-2W-M15	15mm		
IST-2W-M16	16mm		
IST-2W-M17	17mm		
IST-2W-M18	18mm		
IST-2W-M19	19mm		
IST-2W-M21	21mm		
IST-2W-M22	22mm		IST-18W200A IST-18W340A
IST-2W-M13A	13mm		
IST-2W-M14A	14mm		
IST-2W-M15A	15mm		
IST-2W-M16A	16mm		
IST-2W-M17A	17mm		
IST-2W-M18A	18mm		
IST-2W-M19A	19mm		
IST-2W-M21A	21mm		

INTERCHANGEABLE HEAD DIGITAL TORQUE WRENCHES

OPTIONAL ACCURACY:
CLOCKWISE: ±1%
COUNTER-CLOCKWISE: ±2%

**INSPECTION
CERTIFICATE**

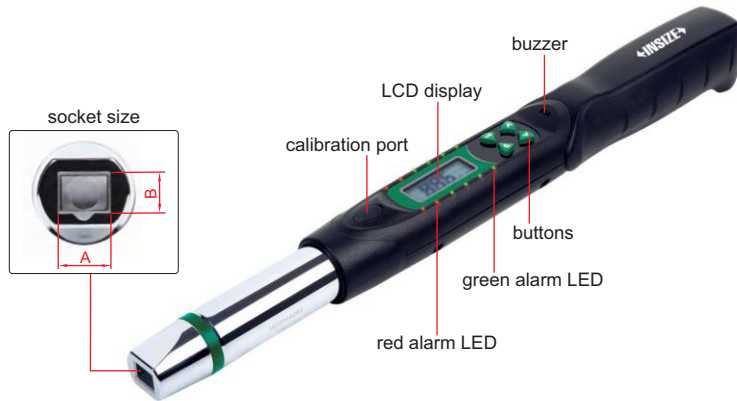

IST-2W135A

32

- Clockwise and counter-clockwise operation
- Unit: N.m, in.lb, ft.lb, kg.cm, degree
- Peak and track working modes
- Target torque value can be set, with audible and visible alarm:
 - Green LED light on and buzzer sounds when torque value is 90%~100% of target torque
 - Both green and red LED light on and buzzer sounds when target torque value is reached
- Power off in 5 minutes automatically without any operations
- Non-slip grip handle
- With damp record
- With overload record (once the torque reaches 110% of the maximum range)

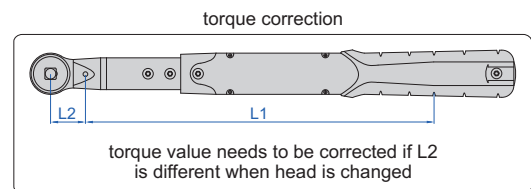
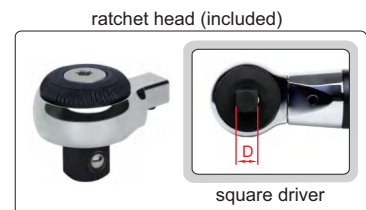

SPECIFICATION

Code	IST-2W30A	IST-2W135A	IST-2W200A	IST-2W340A	IST-2W410A
Range	6~30N.m	27~135N.m	40~200N.m	68~340N.m	82~410N.m
Accuracy	clockwise	±2%			
	counter-clockwise	±3%			
Resolution	0.01N.m	0.1N.m	0.1N.m	0.1N.m	0.1N.m
Socket size (A×B)	12×9mm	12×9mm	18×14mm	18×14mm	18×14mm
Arm length (L1)	272.7mm	287.7mm	381.2mm	501.2mm	501.2mm
Power supply	2xAA batteries, for 110 hours working				
Weight	1400g	1570g	2170g	2320g	2320g

STANDARD DELIVERY

Torque wrench	1 pc
Ratchet head	1 pc

OPTIONAL ACCESSORY

Calibration cable	IST-W-CABLE
Interchangeable head	refer to details

To be continued

Continued from previous page

RATCHET HEAD (INCLUDED) SPECIFICATION

For torque wrench	IST-2W30A	IST-2W135A	IST-2W200A	IST-2W340A	IST-2W410A
Square driver (D)	1/4"	3/8"	1/2"	1/2"	3/4"
Length (L2)	29mm	29mm	40mm	40mm	40mm



RATCHET HEAD (optional)

Code	Square driver (D)	Applicable wrenches
IST-2W-R1	1/4"	IST-2W30A
IST-2W-R2	3/8"	IST-2W135A
IST-2W-R3	1/2"	IST-2W135A
IST-2W-R4	1/2"	IST-2W200A IST-2W340A IST-2W410A

ADJUSTABLE SPANNER HEAD (optional)

Code	Open size	Applicable wrenches
IST-2W-A1	5~27mm	IST-2W30A IST-2W135A
IST-2W-A2	5-30mm	IST-2W200A IST-2W410A
IST-2W-A3	10-41mm	IST-2W340A IST-2W410A



OPEN END HEAD (optional)

Code	Open size	Applicable wrenches
IST-2W-K7	7mm	IST-2W30A IST-2W135A
IST-2W-K8	8mm	
IST-2W-K9	9mm	
IST-2W-K10	10mm	
IST-2W-K11	11mm	
IST-2W-K12	12mm	
IST-2W-K13	13mm	
IST-2W-K14	14mm	
IST-2W-K15	15mm	
IST-2W-K16	16mm	
IST-2W-K17	17mm	
IST-2W-K18	18mm	
IST-2W-K19	19mm	
IST-2W-K13A	13mm	
IST-2W-K14A	14mm	
IST-2W-K15A	15mm	
IST-2W-K16A	16mm	
IST-2W-K17A	17mm	
IST-2W-K18A	18mm	
IST-2W-K19A	19mm	
IST-2W-K21A	21mm	
IST-2W-K22A	22mm	
IST-2W-K24A	24mm	
IST-2W-K27A	27mm	

BOX END HEAD (optional)

Code	Open size	Applicable wrenches	
IST-2W-M7	7mm	IST-2W30A IST-2W135A	
IST-2W-M8	8mm		
IST-2W-M10	10mm		
IST-2W-M11	11mm		
IST-2W-M12	12mm		
IST-2W-M13	13mm		
IST-2W-M14	14mm		
IST-2W-M15	15mm		
IST-2W-M16	16mm		
IST-2W-M17	17mm		
IST-2W-M18	18mm		
IST-2W-M19	19mm		
IST-2W-M21	21mm		
IST-2W-M22	22mm		IST-2W200A IST-2W340A
IST-2W-M13A	13mm		
IST-2W-M14A	14mm		
IST-2W-M15A	15mm		
IST-2W-M16A	16mm		
IST-2W-M17A	17mm		
IST-2W-M18A	18mm		
IST-2W-M19A	19mm		
IST-2W-M21A	21mm		

DIGITAL ANGLE TORQUE WRENCHES



OPTIONAL ACCURACY:
 CLOCKWISE: ±1%
 COUNTER-CLOCKWISE: ±2%
 ONLY FOR RANGE 6~340N.m

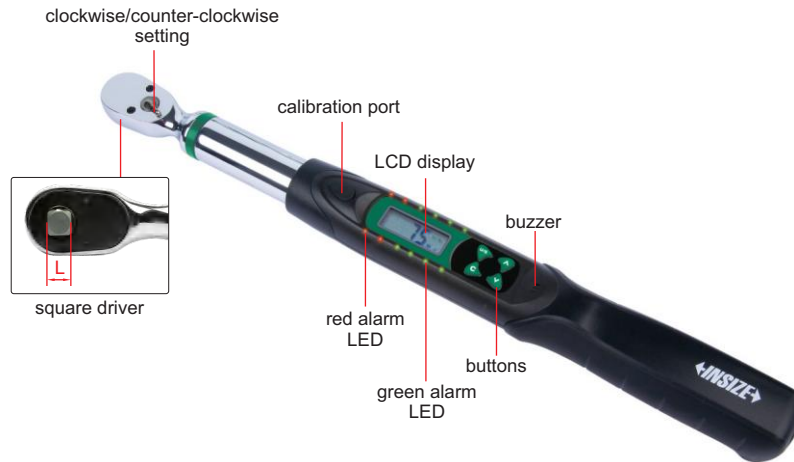

IST-1W135A

32

- Ratchet head
- Clockwise and counter-clockwise operation
- Set the desired torque first, after reaching the desired torque, set the angle and turn the wrench at this angle to apply extra torque
- Unit: N.m, in.lb, ft.lb, kg.cm, degree
- Peak and track working mode
- Target torque or angle value can be set, with audible and visible alarm:
 - Green LED light on and buzzer sounds when torque or angle value is 90%~100% of target torque or angle
 - Both green and red LED light on and buzzer sounds when target torque or angle value is reached
- Power off in 5 minutes automatically
- Non-slip grip handle
- With damp record
- With overload record (once the torque reaches 110% of the maximum range)



set the desired torque first, after reaching the desired torque, set the angle and turn the wrench at this angle to apply extra torque

SPECIFICATION

Code	Range		Accuracy	Resolution		Square driver (L)	Power supply	Length	Weight
	torque	angle		torque	angle				
IST-1W30A	6~30N.m	0~999°	clockwise: ±2% counter-clockwise: ±3% ±2° (rotate 90°)	0.01N.m	1°	1/4"	2×AA batteries	390mm	830g
IST-1W135A	27~135N.m			0.1N.m		3/8"		415mm	950g
IST-1W200A	40~200N.m			0.1N.m		1/2"		530mm	1.4kg
IST-1W340A	68~340N.m			0.1N.m		1/2"		650mm	1.6kg
IST-1W500A	100~500N.m			0.1N.m		3/4"		950mm	5kg
IST-1W850A	170~850N.m		clockwise: ±2.5% counter-clockwise: ±3.5% ±2° (rotate 90°)	0.1N.m		3/4"		1220mm	6kg
IST-1W1200A	240~1200N.m			1N.m		1"		1800mm	9.1kg
IST-1W1500A	300~1500N.m			1N.m		1"		1800mm	9.1kg
IST-1W2000A	400~2000N.m			1N.m		1"		1800mm	10.5kg
								1800mm	

OPTIONAL ACCESSORY

Calibration cable	IST-W-CABLE
-------------------	-------------

OPTIONAL ACCURACY:
CLOCKWISE: $\pm 1\%$
COUNTER-CLOCKWISE: $\pm 2\%$
ONLY FOR RANGE 6~340N.m

MEASURE THE TORQUE
OF TIGHTENED BOLTS

QUALITY INSPECTION TORQUE WRENCHES

**INSPECTION
CERTIFICATE**

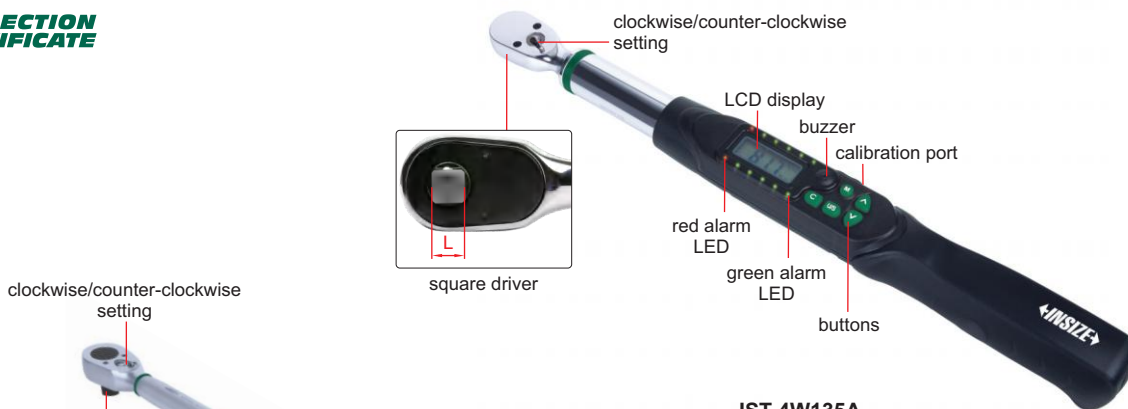

**IST-4W135A
type A**

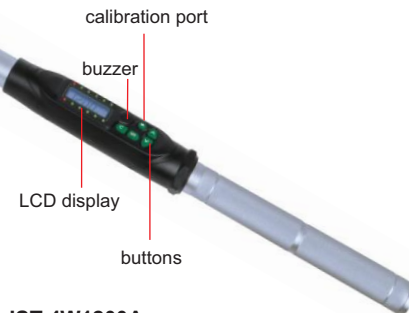
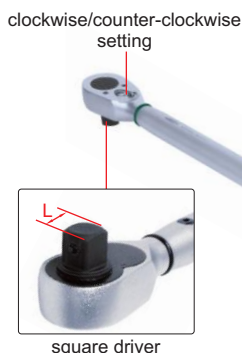

**IST-4W1200A
type B**

- Ratchet head
- Retighten the tightened bolts to measure the torque, read the torque value when the looseness is detected again
- Three measuring modes:
 - Angle mode: rotation angle can be set, when turning to the angle, 2 LED lights blinking and buzzer beeping, capturing torque values
 - Maximum value display mode: capturing peak torque values
 - Real-time value display mode: real-time tracking of torque values
- Unit: N.m, in.lb, ft.lb, kg.cm
- With audible and visible alarm, 9 preset usage modes
- In angle mode and maximum value mode, upper and lower tolerance limits can be set to determine pass or fail by LED lights
- Clockwise and count-clockwise operation
- Memory of 50 results
- Enter power saving mode after 2 minutes
- Non-slip grip handle
- With overload record (once the torque reaches 110% of the maximum range)

SPECIFICATION

Code	Type	Range	Accuracy	Resolution	Square driver (L)	Power supply	Length	Weight
IST-4W30A	A	6~30N.m	clockwise: $\pm 2\%$ counter-clock wise: $\pm 3\%$	0.01N.m	1/4"	2×AA batteries, for 110 hours working	390mm	760g
IST-4W135A		27~135N.m		0.1N.m	3/8"		415mm	940g
IST-4W200A		40~200N.m		0.1N.m	1/2"		530mm	1340g
IST-4W340A		68~340N.m		0.1N.m	1/2"		650mm	1540g
IST-4W850A	B	170~850N.m	clockwise: $\pm 2.5\%$ counter-clock wise: $\pm 3.5\%$	0.1N.m	3/4"		1220mm	6000g
IST-4W1200A		240~1200N.m		1N.m	1"		1800mm	9100g
IST-4W1500A		300~1500N.m		1N.m	1"		1800mm	9100g
IST-4W2000A		400~2000N.m		1N.m	1"		1800mm	10500g

OPTIONAL ACCESSORY

Calibration cable	IST-W-CABLE
-------------------	-------------

INTERCHANGEABLE HEAD QUALITY INSPECTION TORQUE WRENCHES



MEASURE THE TORQUE OF TIGHTENED BOLTS

OPTIONAL ACCURACY:
CLOCKWISE: ±1%
COUNTER-CLOCKWISE: ±2%

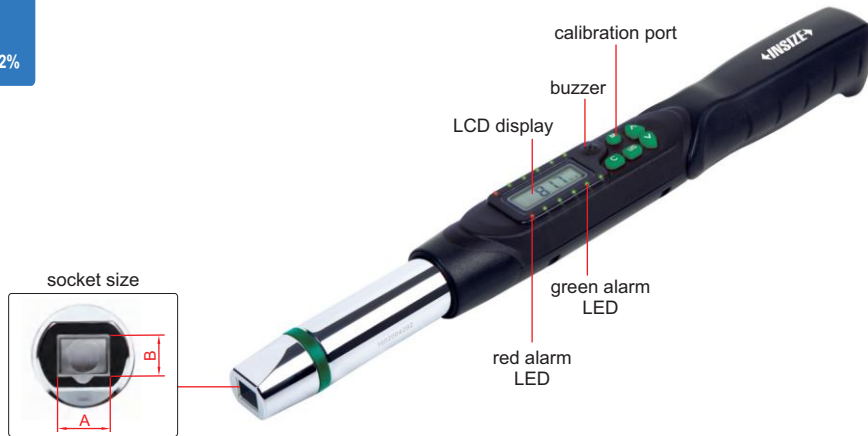

IST-16W135A

- Retighten the tightened bolt to measure the torque, the torque value can be displayed when the bolt is turned again
- Three measuring modes:
 - Angle mode: rotation angle can be set, when turning to the angle, 2 LED lights blinking and buzzer beeping, capturing torque values
 - Maximum value display mode: capturing peak torque values
 - Real-time value display mode: real-time tracking of torque values
- Unit: N.m, in.lb, ft.lb, kg.cm
- With audible and visible alarm, 9 preset usage modes
- In angle mode and maximum value mode, upper and lower tolerance limits can be set to determine pass or fail by LED lights
- Clockwise and count-clockwise operation
- Memory of 50 results
- Enter power saving mode after 2 minutes
- Non-slip grip handle
- With overload record (once the torque reaches 110% of the maximum range)

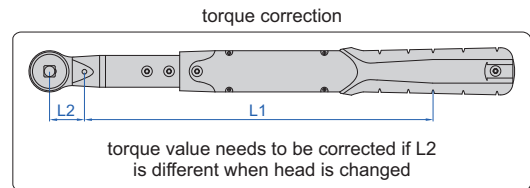
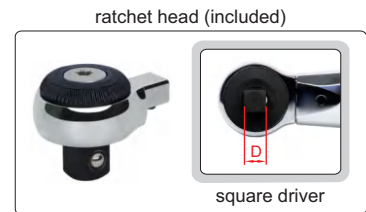

SPECIFICATION

Code	IST-16W30A	IST-16W135A	IST-16W200A	IST-16W340A
Range	6~30N.m	27~135N.m	40~200N.m	68~340N.m
Accuracy	clockwise	±2%		
	counter-clockwise	±3%		
Resolution	0.01N.m	0.1N.m	0.1N.m	0.1N.m
Socket size (A×B)	12×9mm	12×9mm	18×14mm	18×14mm
Arm length (L1)	272.7mm	287.7mm	381.2mm	501.2mm
Power supply	2×AA batteries			
Weight	1400g	1570g	2170g	2320g

RATCHET HEAD (INCLUDED) SPECIFICATION

For torque wrench	IST-16W30A	IST-16W135A	IST-16W200A	IST-16W340A
Square driver (D)	1/4"	3/8"	1/2"	1/2"
Length (L2)	29mm	29mm	40mm	40mm

To be continued

Continued from previous page

STANDARD DELIVERY

Torque wrench	1 pc
Ratchet head	1 pc



OPTIONAL ACCESSORY

Calibration cable	IST-W-CABLE
Interchangeable head	refer to details



RATCHET HEAD (optional)

Code	Square driver (D)	Applicable wrenches
IST-2W-R1	1/4"	IST-16W30A
IST-2W-R2	3/8"	IST-16W135A
IST-2W-R3	1/2"	IST-16W135A
IST-2W-R4	1/2"	IST-16W200A IST-16W340A

ADJUSTABLE SPANNER HEAD (optional)

Code	Open size	Applicable wrenches
IST-2W-A1	5~27mm	IST-16W135A
IST-2W-A2	5-30mm	IST-16W200A
IST-2W-A3	10-41mm	IST-16W340A



OPEN END HEAD (optional)

Code	Open size	Applicable wrenches
IST-2W-K7	7mm	IST-16W30A IST-16W135A
IST-2W-K8	8mm	
IST-2W-K9	9mm	
IST-2W-K10	10mm	
IST-2W-K11	11mm	
IST-2W-K12	12mm	
IST-2W-K13	13mm	
IST-2W-K14	14mm	
IST-2W-K15	15mm	
IST-2W-K16	16mm	
IST-2W-K17	17mm	
IST-2W-K18	18mm	
IST-2W-K19	19mm	
IST-2W-K13A	13mm	
IST-2W-K14A	14mm	
IST-2W-K15A	15mm	
IST-2W-K16A	16mm	
IST-2W-K17A	17mm	
IST-2W-K18A	18mm	
IST-2W-K19A	19mm	
IST-2W-K21A	21mm	
IST-2W-K22A	22mm	
IST-2W-K24A	24mm	
IST-2W-K27A	27mm	

BOX END HEAD (optional)

Code	Open size	Applicable wrenches
IST-2W-M7	7mm	IST-16W30A IST-16W135A
IST-2W-M8	8mm	
IST-2W-M10	10mm	
IST-2W-M11	11mm	
IST-2W-M12	12mm	
IST-2W-M13	13mm	
IST-2W-M14	14mm	
IST-2W-M15	15mm	
IST-2W-M16	16mm	
IST-2W-M17	17mm	
IST-2W-M18	18mm	
IST-2W-M19	19mm	
IST-2W-M21	21mm	
IST-2W-M22	22mm	
IST-2W-M13A	13mm	
IST-2W-M14A	14mm	
IST-2W-M15A	15mm	
IST-2W-M16A	16mm	
IST-2W-M17A	17mm	
IST-2W-M18A	18mm	
IST-2W-M19A	19mm	
IST-2W-M21A	21mm	

DIGITAL TORQUE WRENCHES



OPTIONAL ACCURACY:
CLOCKWISE: ±1%
COUNTER-CLOCKWISE: ±2%
ONLY FOR RANGE 6~850N.m

POPULAR MODEL



IST-W135A type A

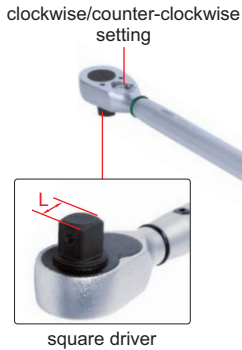

square driver



IST-W1200A type B

- Ratchet head
- Clockwise and counter-clockwise operation
- Unit: N.m, in.lb, ft.lb, kg.cm
- Peak and track working mode
- Target torque value can be set, with audible and visible alarm:
 - Green LED light on and buzzer sounds when torque value is 90%~100% of target torque
 - Both green and red LED light on and buzzer sounds when target torque value is reached
- Power off automatically in 5 minutes without any operations
- Non-slip grip handle
- With damp record
- With overload record (once the torque reaches 110% of the maximum range)

SPECIFICATION

Code	Type	Range	Accuracy	Resolution	Square driver (L)	Power supply	Length	Weight
IST-W30A	A	6~30N.m	clockwise: ±2% counter-clock wise: ±3%	0.01N.m	1/4"	2×AA batteries, for 110 hours working	390mm	830g
IST-W135A		27~135N.m		0.1N.m	3/8"		415mm	950g
IST-W200A		40~200N.m		0.1N.m	1/2"		530mm	1.4kg
IST-W340A		68~340N.m		0.1N.m	1/2"		650mm	1.6kg
IST-W500A*	B	100~500N.m	clockwise: ±2.5% counter-clock wise: ±3.5%	0.1N.m	3/4"		1285mm	7kg
IST-W850A		170~850N.m		0.1N.m	3/4"		1295mm	6kg
IST-W1200A		240~1200N.m		1N.m	1"		1920mm	13kg
IST-W1500A		300~1500N.m		1N.m	1"		1920mm	13kg
IST-W2000A		400~2000N.m		1N.m	1"	1920mm	14kg	

OPTIONAL ACCESSORY

Calibration cable IST-W-CABLE

* The accuracy of this code is not optional



SWING-HEAD DIGITAL TORQUE WRENCHES

- Ratchet head
- Unit: N.m, in.lb, ft.lb, kg.cm
- Clockwise and count-clockwise operation
- Peak and track working mode
- Target torque value can be set, with audible and visible alarm:
 - Green LED light on and buzzer sounds when torque value is 90%~100% of target torque
 - Both green and red LED light on and buzzer sounds when target torque value is reached
- Power off automatically in 5 minutes without any operations
- Non-slip grip handle
- With damp record
- With overload record (once the torque reaches 110% of the maximum range)



OPTIONAL ACCURACY:
CLOCKWISE: $\pm 1\%$
COUNTER-CLOCKWISE: $\pm 2\%$

IST-21W135A

OPTIONAL ACCESSORY

Calibration cable	IST-W-CABLE
-------------------	-------------

SPECIFICATION

Code	IST-21W30A	IST-21W135A	IST-21W200A	IST-21W340A
Range	6~30N.m	27~135N.m	40~200N.m	68~340N.m
Accuracy	clockwise: $\pm 2\%$ (when ratchet head is flush with grip) counter-clockwise: $\pm 3\%$ (when ratchet head is flush with grip)			
Resolution	0.01N.m	0.1N.m	0.1N.m	0.1N.m
Square driver (L)	1/4"	3/8"	1/2"	1/2"
Power supply	2×AA batteries			
Length	390mm	415mm	530mm	650mm
Weight	760g	940g	1340g	1540g



swing-head ratchet head



ADJUSTABLE OPEN HEAD DIGITAL TORQUE WRENCHES

ATTENTION: CLOCKWISE OPERATION ONLY

- The movable jaw of the adjustable open head has a protruding positioning design to ensure accuracy
- Unit: N.m, in.lb, ft.lb, kg.cm
- Peak and track working mode
- Target torque value can be set, with audible and visible alarm:
 - Green LED light on and buzzer sounds when torque value is 90%~100% of target torque
 - Both green and red LED light on and buzzer sounds when target torque value is reached
- Power off automatically in 5 minutes without any operations
- Non-slip grip handle
- With damp record
- With overload record (once the torque reaches 110% of the maximum range)



IST-24W135A26

OPTIONAL ACCESSORY

Calibration cable	IST-W-CABLE
-------------------	-------------

SPECIFICATION

Code	IST-24W60A26	IST-24W85A26	IST-24W135A26	IST-24W135A30	IST-24W200A30	IST-24W200A41	IST-24W340A41
Range	12~60N.m	17~85N.m	27~135N.m	27~135N.m	40~200N.m	40~200N.m	68~340N.m
Adjustable open range	5~26mm	5~26mm	5~26mm	5~30mm	5~30mm	10~41mm	10~41mm
Accuracy	clockwise: $\pm 3\%$						
Resolution	0.01N.m	0.1N.m	0.1N.m	0.1N.m	0.1N.m	0.1N.m	0.1N.m
Power supply	2×AA batteries						
Length	428mm	428mm	428mm	525mm	525mm	650mm	650mm
Weight	1190g	1190g	1190g	1400g	1400g	1600g	1600g

MECHANICAL TORQUE WRENCHES (DIGITAL SETTING)



ATTENTION: DISPLAY PRE-SET TORQUE VALUE (NOT REAL TIME TORQUE)

ATTENTION: CLOCKWISE OPERATION ONLY

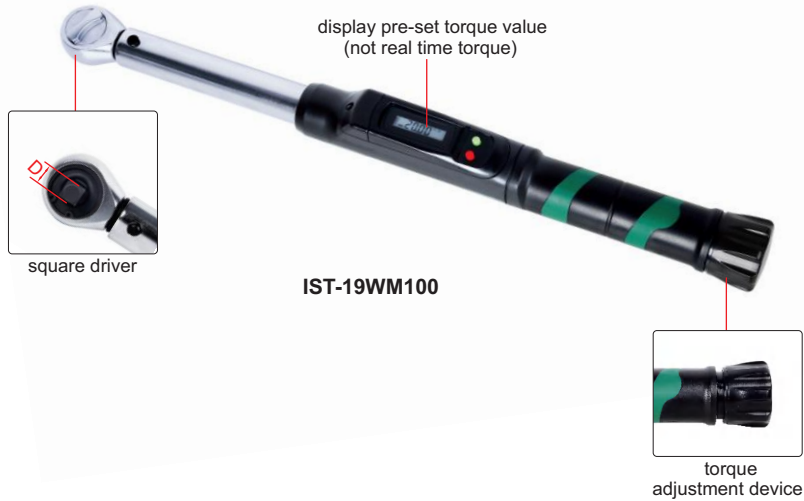

- Ratchet head
- Unit: N.m, in.lb, ft.lb, kg.cm
- Mechanical “click” torque wrench, the pre-set torque value is shown on the display

SPECIFICATION

Code	IST-19WM60	IST-19WM100	IST-19WM140	IST-19WM200	IST-19WM300
Range (clockwise)	12~60N.m	20~100N.m	28~140N.m	40~200N.m	60~300N.m
Accuracy	±3%	±3%	±3%	±3%	±3%
Resolution	0.1N.m	0.1N.m	0.1N.m	0.1N.m	0.1N.m
Square driver (D)	3/8"	3/8"	1/2"	1/2"	1/2"
Length	382mm	450mm	481mm	520mm	585mm
Weight	1.3kg	1.4kg	1.45kg	1.6kg	1.8kg

INTERCHANGEABLE HEAD MECHANICAL TORQUE WRENCHES (DIGITAL SETTING)

ATTENTION: DISPLAY PRE-SET TORQUE VALUE (NOT REAL TIME TORQUE)

ATTENTION: CLOCKWISE OPERATION ONLY



- Unit: N.m, in.lb, ft.lb, kg.cm
- Mechanical “click” torque wrench, the pre-set torque value is shown on the display

SPECIFICATION

Code	IST-25WM60	IST-25WM100	IST-25WM140	IST-25WM200	IST-25WM300
Range (clockwise)	12~60N.m	20~100N.m	28~140N.m	40~200N.m	60~300N.m
Accuracy	±3%	±3%	±3%	±3%	±3%
Resolution	0.1N.m	0.1N.m	0.1N.m	0.1N.m	0.1N.m
Socket size (A×B)	12×9mm	12×9mm	18×14mm	18×14mm	18×14mm
Length	408mm	431mm	492mm	510mm	568mm
Weight	1.3kg	1.4kg	1.45kg	1.5kg	1.7kg

To be continued

Continued from previous page



RATCHET HEAD (optional)

Code	Square driver	Applicable wrenches
IST-11WM-R1	1/4"	IST-25WM60 IST-25WM100
IST-11WM-R2	3/8"	IST-25WM60 IST-25WM100
IST-11WM-R3	1/2"	IST-25WM140 IST-25WM200 IST-25WM300
IST-11WM-R4	3/4"	IST-25WM140 IST-25WM200 IST-25WM300



HOOK HEAD (optional)

Hook head	customized according to customer requirements



OPEN END HEAD (optional)

Code	Open size	Applicable wrenches	
IST-11WM-K6	6mm	IST-25WM60 IST-25WM100	
IST-11WM-K7	7mm		
IST-11WM-K8	8mm		
IST-11WM-K9	9mm		
IST-11WM-K10	10mm		
IST-11WM-K11	11mm		
IST-11WM-K12	12mm		
IST-11WM-K13	13mm		
IST-11WM-K14	14mm		
IST-11WM-K15	15mm		
IST-11WM-K16	16mm		
IST-11WM-K17	17mm		
IST-11WM-K18*	18mm		
IST-11WM-K19*	19mm		
IST-11WM-K13A	13mm		IST-25WM140 IST-25WM200 IST-25WM300
IST-11WM-K14A	14mm		
IST-11WM-K15A	15mm		
IST-11WM-K16A	16mm		
IST-11WM-K17A	17mm		
IST-11WM-K18A	18mm		
IST-11WM-K19A	19mm		
IST-11WM-K20A	20mm		
IST-11WM-K21A	21mm		
IST-11WM-K22A	22mm		
IST-11WM-K23A	23mm		
IST-11WM-K24A	24mm		
IST-11WM-K27A*	27mm		
IST-11WM-K30A*	30mm		
IST-11WM-K32A*	32mm		



BOX END HEAD (optional)

Code	Open size	Applicable wrenches
IST-11WM-M8	8mm	IST-25WM60 IST-25WM100
IST-11WM-M10	10mm	
IST-11WM-M13	13mm	
IST-11WM-M14	14mm	
IST-11WM-M15	15mm	
IST-11WM-M17	17mm	
IST-11WM-M19	19mm	
IST-11WM-M13A	13mm	IST-25WM140 IST-25WM200
IST-11WM-M14A	14mm	
IST-11WM-M15A	15mm	
IST-11WM-M17A	17mm	
IST-11WM-M19A	19mm	
IST-11WM-M22A	22mm	
IST-11WM-M24A	24mm	
IST-11WM-M27A	27mm	
IST-11WM-M30A	30mm	
IST-11WM-M32A	32mm	

* Torque value needs to be corrected for these heads

ATTENTION: CLOCKWISE OPERATION ONLY

INTERCHANGEABLE HEAD TORQUE WRENCHES

INSPECTION CERTIFICATE



IST-29WM200

- According to DIN ISO 6789, ASME B107.300
- Non-slip grip handle
- Push-pull locking device, easy to operate
- Dual window design with clear scale

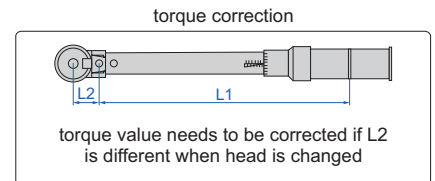

SPECIFICATION

Code	Range (clockwise)	Accuracy	Graduation	Socket Size (A×B)	Length	Weight
IST-29WM25	5~25N.m	±3%	0.2N.m	12×9mm	315mm	700g
IST-29WM50	10~50N.m	±3%	0.5N.m	12×9mm	376mm	820g
IST-29WM60	10~60N.m	±3%	0.5N.m	12×9mm	376mm	820g
IST-29WM100	20~100N.m	±3%	0.5N.m	12×9mm	417mm	900g
IST-29WM150	30~150N.m	±3%	1N.m	18×14mm	460mm	1150g
IST-29WM200	40~200N.m	±3%	1N.m	18×14mm	478mm	1200g
IST-29WM300	60~300N.m	±3%	1.5N.m	18×14mm	538mm	1200g
IST-29WM400	80~400N.m	±3%	2N.m	18×14mm	694mm	1600g
IST-29WM550	100~550N.m	±3% (≤500N.m) ±4% (>500N.m)	3N.m	32×24mm	919mm	2000g
IST-29WM750	150~750N.m	±3% (≤500N.m) ±4% (>500N.m)	5N.m	32×24mm	1070mm	4000g
IST-29WM850	200~850N.m	±3% (≤500N.m) ±4% (>500N.m)	5N.m	32×24mm	1137mm	4200g



RATCHET HEAD (optional)

Code	Square driver	Applicable wrenches
IST-11WM-R1	1/4"	IST-29WM25
IST-11WM-R2	3/8"	IST-29WM25, IST-29WM50, IST-29WM60, IST-29WM100
IST-11WM-R3	1/2"	IST-29WM150, IST-29WM200, IST-29WM300, IST-29WM400
IST-11WM-R4	3/4"	IST-29WM150, IST-29WM200, IST-29WM300, IST-29WM400
IST-11WM-R5	3/4"	IST-29WM550, IST-29WM750, IST-29WM850

To be continued

Continued from previous page

type A (optional)



type C (optional)



type O (optional)



ER WRENCH HEAD (optional)

Type C *	customized according to customer requirements
Type UM *	
Type M *	
Type O *	
Type A *	

type UM (optional)



type M (optional)



OPEN END HEAD (optional)

Code	Open size	Applicable wrenches
IST-11WM-K8	8mm	IST-29WM25 IST-29WM50 IST-29WM60 IST-29WM100
IST-11WM-K10	10mm	
IST-11WM-K13	13mm	
IST-11WM-K14	14mm	
IST-11WM-K15	15mm	
IST-11WM-K17	17mm	
IST-11WM-K19*	19mm	
IST-11WM-K13A	13mm	IST-29WM150 IST-29WM200 IST-29WM300 IST-29WM400
IST-11WM-K14A	14mm	
IST-11WM-K15A	15mm	
IST-11WM-K17A	17mm	
IST-11WM-K19A	19mm	
IST-11WM-K22A	22mm	
IST-11WM-K24A	24mm	
IST-11WM-K27A*	27mm	
IST-11WM-K30A*	30mm	
IST-11WM-K32A*	32mm	
IST-11WM-K22B	22mm	IST-29WM550 IST-29WM750 IST-29WM850
IST-11WM-K24B	24mm	
IST-11WM-K27B	27mm	
IST-11WM-K28B	28mm	
IST-11WM-K30B	30mm	
IST-11WM-K32B	32mm	
IST-11WM-K33B*	33mm	
IST-11WM-K36B*	36mm	
IST-11WM-K38B*	38mm	
IST-11WM-K40B*	40mm	

BOX END HEAD (optional)

Code	Open size	Applicable wrenches
IST-11WM-M8	8mm	IST-29WM25 IST-29WM50 IST-29WM60 IST-29WM100
IST-11WM-M10	10mm	
IST-11WM-M13	13mm	
IST-11WM-M14	14mm	
IST-11WM-M15	15mm	
IST-11WM-M17	17mm	
IST-11WM-M19	19mm	
IST-11WM-M13A	13mm	IST-29WM150 IST-29WM200 IST-29WM300 IST-29WM400
IST-11WM-M14A	14mm	
IST-11WM-M15A	15mm	
IST-11WM-M17A	17mm	
IST-11WM-M19A	19mm	
IST-11WM-M22A	22mm	
IST-11WM-M24A	24mm	
IST-11WM-M27A*	27mm	
IST-11WM-M30A*	30mm	
IST-11WM-M32A*	32mm	
IST-11WM-M22B	22mm	IST-29WM550 IST-29WM750 IST-29WM850
IST-11WM-M24B	24mm	
IST-11WM-K27B	27mm	
IST-11WM-M28B	28mm	
IST-11WM-M30B	30mm	
IST-11WM-M32B	32mm	
IST-11WM-M33B	33mm	
IST-11WM-M36B*	36mm	
IST-11WM-M38B*	38mm	
IST-11WM-M40B*	40mm	

*Torque value needs to be corrected for these heads

ATTENTION: CLOCKWISE OPERATION ONLY



- Ratchet head
- According to DIN ISO 6789, ASME B107.300
- All-metal construction, sturdy and durable



IST-9WM200

SPECIFICATION

Code	IST-9WM12	IST-9WM20	IST-9WM30	IST-9WM60	IST-9WM100
Range (clockwise)	2.5~12N.m	4~20N.m	6~30N.m	10~60N.m	20~100N.m
Accuracy	±3%	±3%	±3%	±3%	±3%
Graduation	0.1N.m	0.1N.m	0.2N.m	0.5N.m	0.5N.m
Square driver (D)	1/4"	1/4"	3/8"	3/8"	1/2"
Length	290mm	290mm	318mm	388mm	443mm
Weight	680g	680g	820g	960g	1040g

Code	IST-9WM125	IST-9WM200	IST-9WM335	IST-9WM500	IST-9WM800
Range (clockwise)	25~125N.m	40~200N.m	65~335N.m	100~500N.m	160~800N.m
Accuracy	±3%	±3%	±3%	±3%	±3% (≤500N.m) ±4% (>500N.m)
Graduation	0.5N.m	1N.m	1N.m	2.5N.m	4N.m
Square driver (D)	1/2"	1/2"	1/2"	3/4"	3/4"
Length	443mm	468mm	528mm	855mm	1055mm
Weight	1040g	1160g	1300g	5000g	5900g

Code	IST-9WM1000	IST-9WM1500	IST-9WM2000	IST-9WM3000
Range (clockwise)	200~1000N.m	300~1500N.m	400~2000N.m	600~3000N.m
Accuracy	±3% (≤500N.m) ±4% (>500N.m)	±3% (≤500N.m) ±4% (>500N.m)	±3% (≤500N.m) ±4% (>500N.m)	±4%
Graduation	5N.m	5N.m	10N.m	15N.m
Square driver (D)	3/4"	1"	1"	1"
Length	1055mm	1260mm	1260mm	1260mm
Weight	5900g	9200g	9200g	10500g

ATTENTION: CLOCKWISE OPERATION ONLY



- Ratchet head
- According to DIN ISO 6789, ASME B107.300
- All-metal construction, sturdy and durable

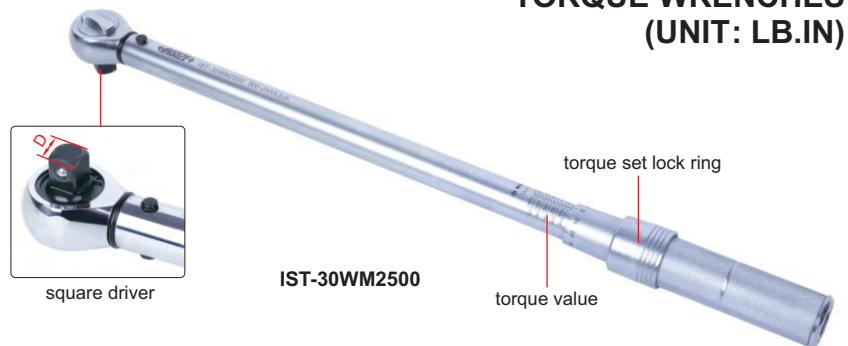

IST-30WM2500

TORQUE WRENCHES (UNIT: LB.IN)

SPECIFICATION

Code	Range (clockwise)	Accuracy	Graduation	Square driver (D)	Length	Weight
IST-30WM50	10~50lb.in	±4%	0.5lb.in	1/4"	183mm	320g
IST-30WM100	20~100lb.in		1lb.in	1/4"	195mm	340g
IST-30WM150	30~150lb.in		1.5lb.in	1/4"	207mm	360g
IST-30WM200	40~200lb.in		1lb.in	1/4"	280mm	680g
IST-30WM250	50~250lb.in		1lb.in	3/8"	315mm	820g
IST-30WM500	100~500lb.in		1lb.in	3/8"	390mm	940g
IST-30WM750	150~750lb.in		1.5lb.in	3/8"	428mm	1040g
IST-30WM1000	200~1000lb.in		2.5lb.in	3/8"	441mm	1130g
IST-30WM2500	500~2500lb.in		10lb.in	1/2"	525mm	1300g

INTERCHANGEABLE HEAD TORQUE WRENCHES

ATTENTION: CLOCKWISE OPERATION ONLY



IST-11WM200

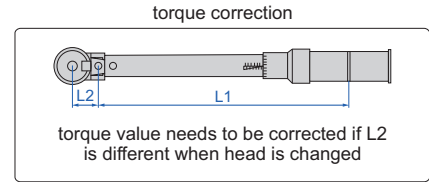

- According to DIN ISO 6789, ASME B107.300
- All-metal construction, sturdy and durable

32

SPECIFICATION

Code	Range (clockwise)	Accuracy	Graduation	Socket size (A×B)	Arm length (L1)	Length (L2)	Weight
IST-11WM12	2.5~12N.m	±3%	0.05N.m	12×9mm	225mm	28.42mm	580g
IST-11WM30	6.0~30N.m	±3%	0.1N.m	12×9mm	243mm	28.42mm	720g
IST-11WM60	10~60N.m	±3%	0.5N.m	12×9mm	314mm	28.42mm	860g
IST-11WM125	25~125N.m	±3%	0.5N.m	12×9mm	367mm	28.42mm	940g
IST-11WM200	40~200N.m	±3%	1N.m	18×14mm	402mm	38.97mm	1060g
IST-11WM335	65~335N.m	±3%	1N.m	18×14mm	458mm	38.97mm	1200g
IST-11WM500	100~500N.m	±3%	2.5N.m	32×24mm	734mm	59mm	5000g
IST-11WM800	160~800N.m	±3% (≤500N.m) ±4% (>500N.m)	4N.m	32×24mm	934mm	59mm	5900g
IST-11WM1000	200~1000N.m	±3% (≤500N.m) ±4% (>500N.m)	5N.m	32×24mm	934mm	59mm	5900g
IST-11WM1500	300~1500N.m	±3% (≤500N.m) ±4% (>500N.m)	5N.m	36×27mm	1128mm	74mm	9000g
IST-11WM2000	400~2000N.m	±3% (≤500N.m) ±4% (>500N.m)	10N.m	36×27mm	1128mm	74mm	9000g
IST-11WM3000	600~3000N.m	±4%	15N.m	36×27mm	1136mm	74mm	10300g

type A (optional)



type C (optional)



type O (optional)



ER WRENCH HEAD (optional)

Type C *	customized according to customer requirements
Type UM *	
Type M *	
Type O *	
Type A *	

type UM (optional)



type M (optional)



To be continued

Continued from previous page



RATCHET HEAD (optional)

Code	Square driver	Applicable wrenches
IST-11WM-R1	1/4"	IST-11WM12, IST-11WM30
IST-11WM-R2	3/8"	IST-11WM12, IST-11WM30, IST-11WM60, IST-11WM125
IST-11WM-R3	1/2"	IST-11WM200, IST-11WM335
IST-11WM-R4	3/4"	IST-11WM200, IST-11WM335
IST-11WM-R5	3/4"	IST-11WM500, IST-11WM800, IST-11WM1000
IST-11WM-R6	1"	IST-11WM1500, IST-11WM2000, IST-11WM3000



OPEN END HEAD (optional)

Code	Open size	Applicable wrenches
IST-11WM-K8	8mm	IST-11WM12 IST-11WM30 IST-11WM60 IST-11WM125
IST-11WM-K10	10mm	
IST-11WM-K13	13mm	
IST-11WM-K14	14mm	
IST-11WM-K15	15mm	
IST-11WM-K17	17mm	
IST-11WM-K19*	19mm	IST-11WM200 IST-11WM335
IST-11WM-K13A	13mm	
IST-11WM-K14A	14mm	
IST-11WM-K15A	15mm	
IST-11WM-K17A	17mm	
IST-11WM-K19A	19mm	
IST-11WM-K22A	22mm	
IST-11WM-K24A	24mm	
IST-11WM-K27A*	27mm	
IST-11WM-K30A*	30mm	
IST-11WM-K32A*	32mm	IST-11WM500 IST-11WM800 IST-11WM1000
IST-11WM-K22B	22mm	
IST-11WM-K24B	24mm	
IST-11WM-K27B	27mm	
IST-11WM-K28B	28mm	
IST-11WM-K30B	30mm	
IST-11WM-K32B	32mm	
IST-11WM-K33B*	33mm	
IST-11WM-K36B*	36mm	
IST-11WM-K38B*	38mm	
IST-11WM-K40B*	40mm	IST-11WM1500 IST-11WM2000 IST-11WM3000
IST-11WM-K30C	30mm	
IST-11WM-K32C	32mm	
IST-11WM-K34C	34mm	
IST-11WM-K36C	36mm	
IST-11WM-K38C	38mm	
IST-11WM-K41C	41mm	
IST-11WM-K45C	45mm	
IST-11WM-K50C*	50mm	
IST-11WM-K55C*	55mm	
IST-11WM-K60C*	60mm	

BOX END HEAD (optional)

Code	Open size	Applicable wrenches
IST-11WM-M8	8mm	IST-11WM12 IST-11WM30 IST-11WM60 IST-11WM125
IST-11WM-M10	10mm	
IST-11WM-M13	13mm	
IST-11WM-M14	14mm	
IST-11WM-M15	15mm	
IST-11WM-M17	17mm	
IST-11WM-M19	19mm	IST-11WM200 IST-11WM335
IST-11WM-M13A	13mm	
IST-11WM-M14A	14mm	
IST-11WM-M15A	15mm	
IST-11WM-M17A	17mm	
IST-11WM-M19A	19mm	
IST-11WM-M22A	22mm	
IST-11WM-M24A	24mm	
IST-11WM-M27A*	27mm	
IST-11WM-M30A*	30mm	
IST-11WM-M32A*	32mm	IST-11WM500 IST-11WM800 IST-11WM1000
IST-11WM-M22B	22mm	
IST-11WM-M24B	24mm	
IST-11WM-K27B	27mm	
IST-11WM-M28B	28mm	
IST-11WM-M30B	30mm	
IST-11WM-M32B	32mm	
IST-11WM-M33B	33mm	
IST-11WM-M36B*	36mm	
IST-11WM-M38B*	38mm	
IST-11WM-M40B*	40mm	IST-11WM1500 IST-11WM2000 IST-11WM3000
IST-11WM-M30C	30mm	
IST-11WM-M32C	32mm	
IST-11WM-M34C	34mm	
IST-11WM-M36C	36mm	
IST-11WM-M38C	38mm	
IST-11WM-M41C	41mm	
IST-11WM-M45C	45mm	
IST-11WM-M50C	50mm	
IST-11WM-M55C*	55mm	
IST-11WM-M60C*	60mm	

*Torque value needs to be corrected for these heads

EXTENDED HANDLE TORQUE WRENCHES

ATTENTION: CLOCKWISE OPERATION ONLY

ATTENTION: MUST BE USED WITH EXTENDED HANDLE

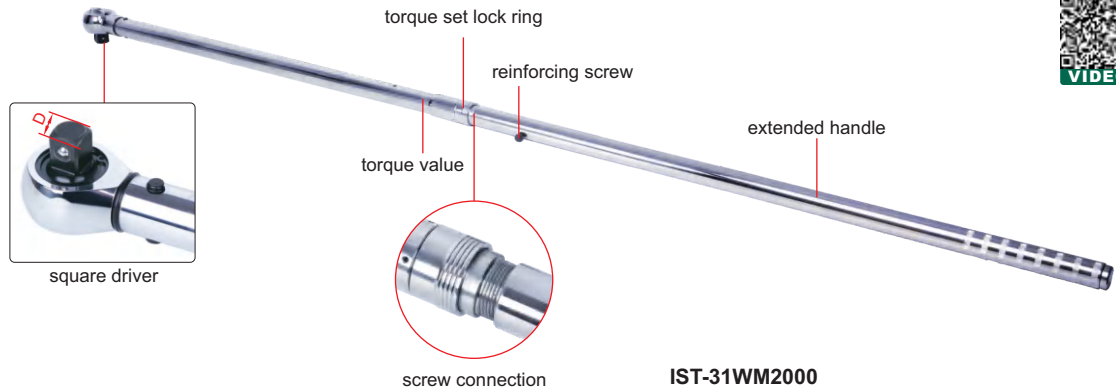

- Ratchet head
- According to DIN ISO 6789, ASME B107.300
- All-metal construction, sturdy and durable
- Extended handle for less force

IST-31WM2000

SPECIFICATION

Code	Range (clockwise)	Accuracy	Graduation	Square driver (D)	Length	Weight
IST-31WM1500	300~1500N.m	±4%	5N.m	1"	2200mm	12100g
IST-31WM2000	400~2000N.m		10N.m	1"	2200mm	12100g
IST-31WM3000	600~3000N.m		15N.m	1"	2780mm	15500g

EXTENDED HANDLE INTERCHANGEABLE HEAD TORQUE WRENCHES

ATTENTION: CLOCKWISE OPERATION ONLY

ATTENTION: MUST BE USED WITH EXTENDED HANDLE

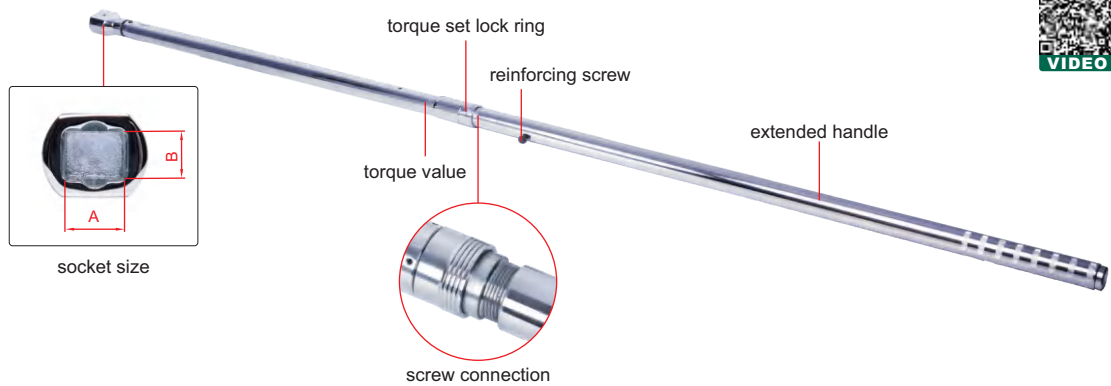

- According to DIN ISO 6789, ASME B107.300
- All-metal construction, sturdy and durable
- Extended handle for less force

IST-32WM2000

SPECIFICATION

Code	Range (clockwise)	Accuracy	Graduation	Socket size (A×B)	Length	Weight
IST-32WM1500	300~1500N.m	±4%	5N.m	36×27mm	2200mm	12500g
IST-32WM2000	400~2000N.m		10N.m	36×27mm	2200mm	12500g
IST-32WM3000	600~3000N.m		15N.m	36×27mm	2780mm	15300g

To be continued

Continued from previous page

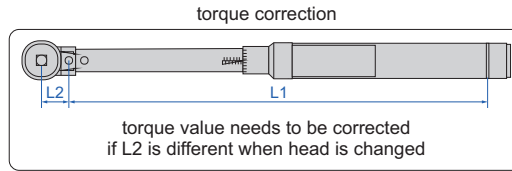

type A (optional)



type C (optional)



type O (optional)



ER WRENCH HEAD (optional)

Type C *	customized according to customer requirements
Type UM *	
Type M *	
Type O *	
Type A *	

type UM (optional)



type M (optional)



RATCHET HEAD (optional)

Code	Square driver	Applicable wrenches
IST-11WM-R6	1"	IST-32WM1500, IST-32WM2000, IST-32WM3000



OPEN END HEAD (optional)

Code	Open size	Applicable wrenches
IST-11WM-K30C	30mm	IST-32WM1500 IST-32WM2000 IST-32WM3000
IST-11WM-K32C	32mm	
IST-11WM-K34C	34mm	
IST-11WM-K36C	36mm	
IST-11WM-K38C	38mm	
IST-11WM-K41C	41mm	
IST-11WM-K45C	45mm	
IST-11WM-K50C *	50mm	
IST-11WM-K55C *	55mm	
IST-11WM-K60C *	60mm	

BOX END HEAD (optional)

Code	Open size	Applicable wrenches
IST-11WM-M30C	30mm	IST-32WM1500 IST-32WM2000 IST-32WM3000
IST-11WM-M32C	32mm	
IST-11WM-M34C	34mm	
IST-11WM-M36C	36mm	
IST-11WM-M38C	38mm	
IST-11WM-M41C	41mm	
IST-11WM-M45C	45mm	
IST-11WM-M50C	50mm	
IST-11WM-M55C *	55mm	
IST-11WM-M60C *	60mm	

*Torque value needs to be corrected for these heads

PRESET TORQUE WRENCHES

ATTENTION: CLOCKWISE OPERATION ONLY



IST-PW20

- Ratchet head
- Torque is preset, to prevent adjustment by mistake during use
- The torque is set at the factory before delivery. Customers can also set the torque with torque adjustment tool (IST-PW-TOOL, optional) and digital torque testers (IST-TT□□□, optional)
- Clockwise operation only



torque adjustment tool (optional)

SPECIFICATION

Code	IST-PW12	IST-PW20	IST-PW30	IST-PW60
Adjustable range*	2.5~12N.m 22~105in.lb	4~20N.m 36~175in.lb	6~30N.m 55~265in.lb	10~60N.m 8~44ft.lb
Accuracy	±3%	±3%	±3%	±3%
Square driver (D)	1/4"	1/4"	3/8"	3/8"
Length	184mm	184mm	214mm	255mm
Weight	450g	450g	500g	560g

Code	IST-PW125	IST-PW200	IST-PW340	IST-PW500
Adjustable range*	25~125N.m 20~90ft.lb	40~200N.m 30~145ft.lb	65~340N.m 50~250ft.lb	100~500N.m 75~365ft.lb
Accuracy	±3%	±3%	±3%	±3%
Square driver (D)	3/8"	1/2"	1/2"	3/4"
Length	366mm	457mm	691mm	910mm
Weight	790g	1200g	1960g	2800g

Code	IST-PW650	IST-PW800	IST-PW1000A	IST-PW1000B
Adjustable range*	150~650N.m 110~475ft.lb	160~800N.m 120~585ft.lb	200~1000N.m 150~735ft.lb	200~1000N.m 150~735ft.lb
Accuracy	±4%	±4%	±4%	±4%
Square driver (D)	3/4"	3/4"	3/4"	1"
Length	910mm	1037mm	1265mm	1265mm
Weight	2800g	5000g	6000g	6000g

OPTIONAL ACCESSORY

Torque adjustment tool	IST-PW-TOOL
------------------------	-------------

* Adjust to a fixed torque value according to customer requirements before delivery



DIAL TORQUE WRENCHES

- Clockwise and counter-clockwise operation
- According to DIN ISO 6789, ASME B107.300



IST-DW70

SPECIFICATION

Code	IST-DW1D8	IST-DW3D5	IST-DW9	IST-DW18	IST-DW35
Range	0.36~1.8N.m 3~16in.lb	0.7~3.5N.m 6~30in.lb	1.8~9N.m 15~75in.lb	3.6~18N.m 30~150in.lb	7~35N.m 60~300in.lb
Accuracy	±4%	±4%	±4%	±4%	±4%
Graduation	0.02N.m 0.2in.lb	0.05N.m 0.5in.lb	0.1N.m 1in.lb	0.2N.m 2in.lb	0.5N.m 5in.lb
Square driver (D)	1/4"	1/4"	1/4"	3/8"	3/8"
Length	254mm	254mm	254mm	254mm	254mm
Weight	480g	480g	480g	480g	480g

Code	IST-DW70	IST-DW140	IST-DW240	IST-DW350	IST-DW480
Range	14~70N.m 120~600in.lb	28~140N.m 20~100ft.lb	48~240N.m 35~175ft.lb	70~350N.m 50~250ft.lb	96~480N.m 70~350ft.lb
Accuracy	±4%	±4%	±4%	±4%	±4%
Graduation	1N.m 10in.lb	2N.m 1ft.lb	3N.m 2.5ft.lb	2.5N.m 2.5ft.lb	6N.m 5ft.lb
Square driver (D)	3/8"	1/2"	1/2"	1/2"	3/4"
Length	378mm	546mm	546mm	546mm	708mm
Weight	820g	1300g	1300g	1300g	4030g

WRENCH SOCKETS

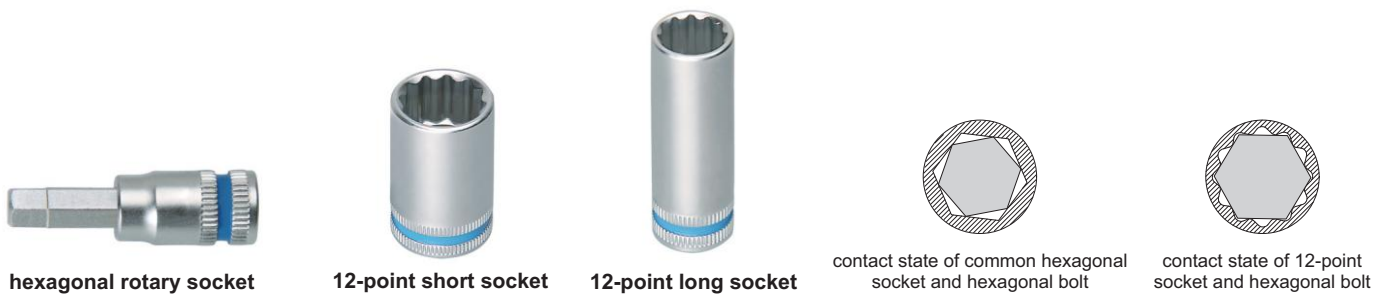

- Cold extrusion molding of 6150# Cr-V steel, withstand 25%-50% more torque than carbon steel socket
- 12-point socket, arc inner corner design, so that the socket and bolt contact surface for edge contact, do not damage the bolt, improve the life of the bolt

To be continued

Continued from previous page

1/4" 12-POINT SHORT SOCKET

Code	Capacity	Length
IST-S-A4	4mm	24.5mm
IST-S-A4D5	4.5mm	24.5mm
IST-S-A5	5mm	24.5mm
IST-S-A5D5	5.5mm	24.5mm
IST-S-A6	6mm	24.5mm
IST-S-A7	7mm	24.5mm
IST-S-A8	8mm	24.5mm
IST-S-A9	9mm	24.5mm
IST-S-A10	10mm	24.5mm
IST-S-A11	11mm	24.5mm
IST-S-A12	12mm	24.5mm
IST-S-A13	13mm	24.5mm
IST-S-A14	14mm	24.5mm

3/8" 12-POINT SHORT SOCKET

Code	Capacity	Length
IST-S-D6	6mm	25mm
IST-S-D7	7mm	25mm
IST-S-D8	8mm	25mm
IST-S-D9	9mm	25mm
IST-S-D10	10mm	25mm
IST-S-D11	11mm	25mm
IST-S-D12	12mm	25mm
IST-S-D13	13mm	25mm
IST-S-D14	14mm	25mm
IST-S-D15	15mm	25mm
IST-S-D16	16mm	25mm
IST-S-D17	17mm	25mm
IST-S-D18	18mm	25mm
IST-S-D19	19mm	28mm
IST-S-D20	20mm	28mm
IST-S-D21	21mm	28mm
IST-S-D22	22mm	31.5mm
IST-S-D24	24mm	31.5mm

1/2" 12-POINT SHORT SOCKET

Code	Capacity	Length
IST-S-G8	8mm	37.8mm
IST-S-G9	9mm	37.8mm
IST-S-G10	10mm	37.8mm
IST-S-G11	11mm	37.8mm
IST-S-G12	12mm	37.8mm
IST-S-G13	13mm	37.8mm
IST-S-G14	14mm	37.8mm
IST-S-G15	15mm	37.8mm
IST-S-G16	16mm	37.8mm
IST-S-G17	17mm	37.8mm
IST-S-G18	18mm	37.8mm
IST-S-G19	19mm	37.8mm
IST-S-G20	20mm	37.8mm
IST-S-G21	21mm	37.8mm
IST-S-G22	22mm	40mm
IST-S-G23	23mm	40mm
IST-S-G24	24mm	40mm
IST-S-G27	27mm	43mm
IST-S-G30	30mm	43mm
IST-S-G32	32mm	43mm

1/4" 12-POINT LONG SOCKET

Code	Capacity	Length
IST-S-B4	4mm	49mm
IST-S-B5	5mm	49mm
IST-S-B6	6mm	49mm
IST-S-B7	7mm	49mm
IST-S-B8	8mm	49mm
IST-S-B9	9mm	49mm
IST-S-B10	10mm	49mm
IST-S-B11	11mm	49mm
IST-S-B12	12mm	49mm
IST-S-B13	13mm	49mm

3/8" 12-POINT LONG SOCKET

Code	Capacity	Length
IST-S-E8	8mm	63.5mm
IST-S-E9	9mm	63.5mm
IST-S-E10	10mm	63.5mm
IST-S-E11	11mm	63.5mm
IST-S-E12	12mm	63.5mm
IST-S-E13	13mm	63.5mm
IST-S-E14	14mm	63.5mm
IST-S-E15	15mm	63.5mm
IST-S-E16	16mm	63.5mm
IST-S-E17	17mm	63.5mm
IST-S-E18	18mm	63.5mm
IST-S-E19	19mm	63.5mm
IST-S-E20	20mm	63.5mm
IST-S-E21	21mm	63.5mm
IST-S-E22	22mm	63.5mm

1/2" 12-POINT LONG SOCKET

Code	Capacity	Length
IST-S-H8	8mm	77mm
IST-S-H9	9mm	77mm
IST-S-H10	10mm	77mm
IST-S-H11	11mm	77mm
IST-S-H12	12mm	77mm
IST-S-H13	13mm	77mm
IST-S-H14	14mm	77mm
IST-S-H15	15mm	77mm
IST-S-H16	16mm	77mm
IST-S-H17	17mm	77mm
IST-S-H18	18mm	77mm
IST-S-H19	19mm	77mm
IST-S-H20	20mm	77mm
IST-S-H21	21mm	77mm
IST-S-H22	22mm	77mm
IST-S-H23	23mm	77mm
IST-S-H24	24mm	77mm
IST-S-H25	25mm	77mm
IST-S-H26	26mm	77mm
IST-S-H27	27mm	77mm
IST-S-H28	28mm	77mm
IST-S-H29	29mm	77mm
IST-S-H30	30mm	77mm
IST-S-H32	32mm	77mm

1/4" HEXAGONAL ROYARY SOCKET

Code	Capacity	Length
IST-S-C3	3mm	37mm
IST-S-C4	4mm	37mm
IST-S-C5	5mm	37mm
IST-S-C6	6mm	37mm
IST-S-C8	8mm	37mm

3/8" HEXAGONAL ROYARY SOCKET

Code	Capacity	Length
IST-S-F3	3mm	50mm
IST-S-F4	4mm	50mm
IST-S-F5	5mm	50mm
IST-S-F6	6mm	50mm
IST-S-F7	7mm	50mm
IST-S-F8	8mm	50mm
IST-S-F10	10mm	50mm

1/2" HEXAGONAL ROYARY SOCKET

Code	Capacity	Length
IST-S-I5	5mm	180mm
IST-S-I6S	6mm	70mm
IST-S-I6	6mm	140mm
IST-S-I6L	6mm	250mm
IST-S-I7	7mm	100mm
IST-S-I8	8mm	120mm
IST-S-I10	10mm	140mm
IST-S-I17	17mm	50mm

3/4" 12-POINT SOCKET

Code	Capacity	Length
IST-S-J19	19mm	50mm
IST-S-J21	21mm	50mm
IST-S-J22	22mm	50mm
IST-S-J23	23mm	50mm
IST-S-J24	24mm	51mm
IST-S-J25	25mm	52mm
IST-S-J26	26mm	52mm
IST-S-J27	27mm	52mm
IST-S-J28	28mm	52mm
IST-S-J29	29mm	54mm
IST-S-J30	30mm	56mm
IST-S-J32	32mm	56mm
IST-S-J33	33mm	56mm
IST-S-J34	34mm	56mm
IST-S-J35	35mm	58mm
IST-S-J36	36mm	58mm
IST-S-J38	38mm	60mm
IST-S-J41	41mm	64mm
IST-S-J46	46mm	68mm
IST-S-J50	50mm	72mm
IST-S-J55	55mm	76mm
IST-S-J60	60mm	78mm



DIGITAL TORQUE ADAPTERS (WITH ANGLE DETECTION)

working with mechanical wrenches



- Clockwise and counter-clockwise operation
- After reaching the desired torque, turn the wrench at a angle to apply extra torque
- Unit: N.m, in.lb, ft.lb, kg.cm, degree
- Peak and track working modes
- Target torque or angle value can be set, with audible and visible alarm:
 - Green LED light on and buzzer sounds when torque or angle value is 80%~100% of target torque or angle
 - Both green and red LED light on and buzzer sounds when target torque or angle value is reached
- Power off in 2 minutes automatically
- Memory 50 measurement values for browsing
- With overload record (once the torque reaches 110% of the maximum range)



IST-5W135A

SPECIFICATION

Code		IST-5W30A	IST-5W135A	IST-5W200A	IST-5W340A
Range	torque	6~30N.m	27~135N.m	40~200N.m	68~340N.m
	angle	0~999°			
Accuracy	clockwise	±3%			
	counter-clockwise	±4%			
	angle	±2° (rotate at 90°)			
Resolution	torque	0.01N.m	0.1N.m	0.1N.m	0.1N.m
	angle	1°			
Square driver (L)		1/4"	3/8"	1/2"	1/2"
Power supply		2xAAA batteries			
Dimension		Ø85×60mm	Ø85×75mm	Ø85×80mm	Ø85×80mm
Weight		150g	220g	240g	240g

OPTIONAL ACCESSORY

Calibration cable	IST-SD-CABLE
-------------------	--------------

REFER TO PAGE 410 FOR DETAILS

DIGITAL ANGLE METER CODE 2177-121



TORQUE MULTIPLIERS



IST-TM2000

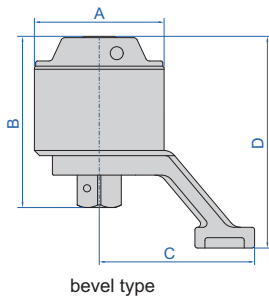

IST-TM3500P

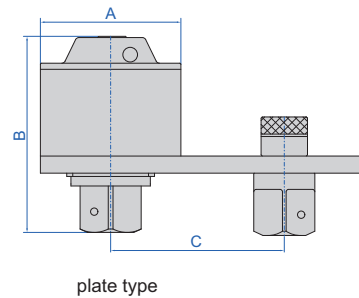

32

application

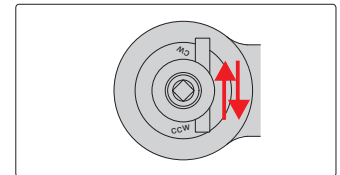

after tightening, toggle the anti-bounce reversing dowel, turn the wrench in the anticlockwise direction, then remove the wrench from torque multiplier

Input to output accuracy: ±5%

Z TYPE (BEVEL TYPE) TORQUE MULTIPLIER

Code	Capacity	Torque ratio	Square socket	Square driver	Dimension (A×B×C×D)	For bolt	For nut	Weight
IST-TM1000	1000N.m	1:4	1/2"	1"	82×98.5×97×122.4mm	M20~30	S30~46	2.1kg
IST-TM2000	2000N.m	1:13	1/2"	1"	82×120×105×147mm	M22~35	S32~55	3.15kg
IST-TM3500	3500N.m	1:16	1/2"	1"	98×131×120×163mm	M30~45	S46~70	4.9kg
IST-TM5500	5500N.m	1:20.5	1/2"	1 1/2"	115×163.5×137×199mm	M38~52	S55~80	8.1kg
IST-TM7500	7500N.m	1:23	1/2"	1 1/2"	127×173×146×215mm	M42~60	S65~90	10.6kg
IST-TM10000	10000N.m	1:28	1/2"	1 1/2"	141×170×164×238mm	M52~72	S80~105	14kg

L TYPE (PLATE TYPE) TORQUE MULTIPLIER

Code	Capacity	Torque ratio	Square socket	Square driver	Dimension (A×B×C)	For bolt	For nut	Weight
IST-TM1000P	1000N.m	1:4	1/2"	1"	82×91×(76.7~127.3)mm	M20~30	S30~46	2.4kg
IST-TM2000P	2000N.m	1:13	1/2"	1"	82×120×(92.7~129.3)mm	M22~35	S32~55	3.5kg
IST-TM3500P	3500N.m	1:16	1/2"	1"	98×128×(102.7~145.3)mm	M30~45	S46~70	5.0kg
IST-TM5500P	5500N.m	1:20.5	1/2"	1 1/2"	115×157×(134.05~165.95)mm	M38~52	S55~80	8.7kg
IST-TM7500P	7500N.m	1:23	1/2"	1 1/2"	127×168×(139.05~190.95)mm	M42~60	S65~90	11.7kg
IST-TM10000P	10000N.m	1:28	1/2"	1 1/2"	141×186×(144.05~215.95)mm	M52~72	S80~105	15.2kg
IST-TM15000P	15000N.m	1:50	3/4"	2 1/2"	156×246×(155.25~244.75)mm	M60~85	S80~120	24.1kg
IST-TM20000P	20000N.m	1:76	3/4"	2 1/2"	170×264×(163.75~276.25)mm	M72~100	S105~145	27.8kg

SPLINE-TYPE TORQUE MULTIPLIERS



after tightening, toggle the anti-bounce reversing dowel, turn the wrench in the anticlockwise direction, then remove the wrench from torque multiplier

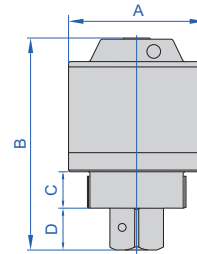
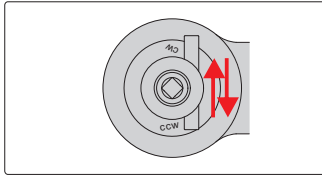

IST-ST2000

application



- High efficiency gear set with small input torque and large output torque
- Can be installed directly on the workpieces or through different options to form different installation types

plate type

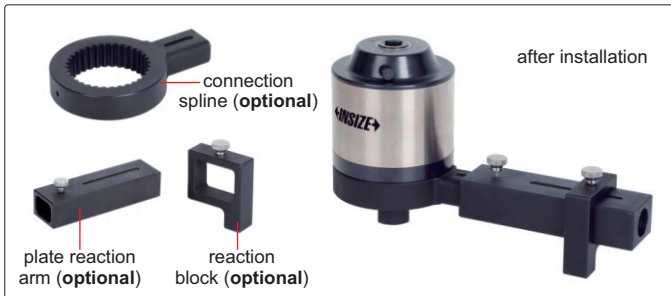

bevel type



SPECIFICATION

Code	Capacity	Accuracy	Torque ratio	Square socket	Square driver	Dimension (A×B×C×D)	For bolt	For nut	Weight	
IST-ST2000	2000N.m	±5%	1:13.3 (plate)	1/2"	1"	82×135×18×26mm	M22~35	S32~55	3.2kg	
			1:12 (bevel)							
IST-ST3500	3500N.m		1:16 (plate)	1/2"	1"	98×150×25×26mm	M30~45	S46~70		4.8kg
			1:15 (bevel)							
IST-ST5500	5500N.m		1:21.5 (plate)	1/2"	1 1/2"	115×180×29×39mm	M38~52	S55~80		7.8kg
			1:18.5 (bevel)							
IST-ST7500	7500N.m	1:24 (plate)	1/2"	1 1/2"	127×198×34×39mm	M42~60	S65~90	10.8kg		
		1:20 (bevel)								



CONNECTION SPLINE (optional)

Code	Dimension (mm)			
	R	L	L1	M
IST-ST2000-C1	41	78	18	5
IST-ST3500-C2	49	95	23	5
IST-ST5500-C3	58	112	28.5	6
IST-ST7500-C4	63.5	123.5	29	6

PLATE REACTION ARM (optional)

Code	Dimension (mm)			
	L	L1	L2	M
IST-ST2000-P1	120	38	25.5	4
IST-ST3500-P2	145	42	32	5
IST-ST5500-P3	150	53	45	6
IST-ST7500-P4	175	60	49	8

To be continued

Continued from previous page

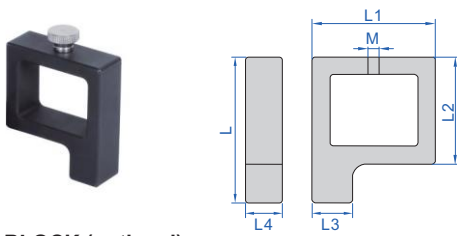

REACTION BLOCK (optional)

Code	Dimension (mm)					
	L	L1	L2	L3	L4	M
IST-ST2000-R1	53.5	52	39.5	15	18	4
IST-ST3500-R2	66	58	48	18	20	5
IST-ST5500-R3	94.5	73	65	22	25	6
IST-ST7500-R4	98	83	72	28	25	8

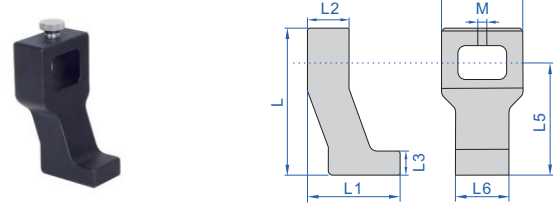

BEVEL REACTION ARM (optional)

Code	Dimension (mm)								
	L	L1	L2	L3	L4	L5	L6	M	
IST-ST2000-B1	85	51	18	14	44	60	25	4	
IST-ST3500-B2	87.5	52	20	15	50	67	30	5	
IST-ST5500-B3	110	70	30	16	59	86	35	6	
IST-ST7500-B4	123	78	35	20	68	94	45	6	

TWO-USE TORQUE MULTIPLIERS

32



IST-DT2000

- High efficiency gear set with small input torque and large output torque
- The reaction arm can adjust the position of the applied force according to the operation conditions
- Plate reaction arm and bevel reaction arm are included

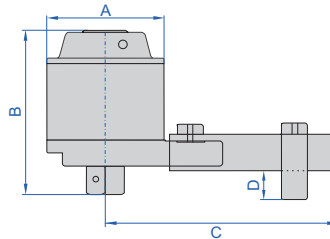
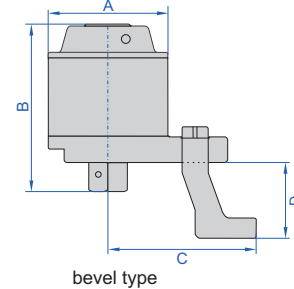
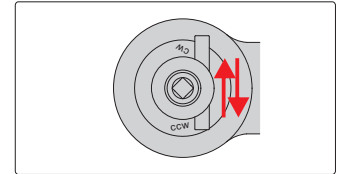

plate type



bevel type

after tightening, toggle the anti-bounce reversing dowel, turn the wrench in the anticlockwise direction, then remove the wrench from torque multiplier



application



torque wrench

plate type

bevel type



SPECIFICATION

Code	Capacity	Accuracy	Torque ratio	Square socket	Square driver	Dimension (A×B×C×D)	For bolt	For nut	Weight
IST-DT2000	2000N.m	±5%	1:13.3 (plate)	1/2"	1"	82×120×160×21mm	M22~35	S32~55	4.1kg
			1:12 (bevel)			82×120×93×52mm			
IST-DT3500	3500N.m		1:16 (plate)	1/2"	1"	98×133×152×26mm	M30~45	S46~70	6.4kg
			1:15 (bevel)			98×133×117×56mm			
IST-DT5500	5500N.m		1:21.5 (plate)	1/2"	1 1/2"	115×165×210×39.5mm	M38~52	S55~80	11.4kg
			1:18.5 (bevel)			115×165×134×72mm			
IST-DT7500	7500N.m		1:24 (plate)	1/2"	1 1/2"	127×174×243×38mm	M42~60	S65~90	16kg
			1:20 (bevel)			127×174×146×80mm			



Coating Thickness Gauges
Page 1039-1046



Plating Thickness Instruments
Page 1047



Surface Profile Gauges
Page 1048-1049



Wet Film Gauges
Page 1049



Gloss Meters
Page 1050-1053



Holiday Detectors
Page 1054



Spectrophotometers
Page 1055-1064



Digital Adhesion Testers
Page 1065



Pencil Hardness Testers
Page 1066



Rotational Abrasion Testers
Page 1066



Cross Cut Adhesion Testers
Page 1067



Conical Mandrel Test Apparatus
Page 1068



Paint Film Flexibility Testers
Page 1068



Impact Testers
Page 1069

COATING THICKNESS GAUGE (HIGH PRECISION) CODE ISO-8000FN

SUITABLE FOR THIN COATING
BELOW 10µm

FOR MAGNETIC AND
NON-MAGNETIC SUBSTRATES



calibration foils (included)



zero calibration plate (included)



stand (optional)



eddy current probe N2000 (optional)



eddy current probe N1500 (optional)



VIDEO



magnetic induction probe F500 (included)

33

- Can measure thickness of thin coating below 10µm
- High repeatability
- Magnetic induction probe measures the thickness of non-magnetic coating and non-metallic coating on magnetic metal substrate
Substrate: iron, steel, magnetic stainless steel (not for non-magnetic stainless steel)
Coating: zinc, aluminum, copper, chrome, tin, plastic, powder, paint (not for nickel)
- Eddy current probe measures the thickness of non-conductive coating on non-magnetic metal substrate
Substrate: copper, aluminum, zinc, non-magnetic stainless steel
Coating: plastic, powder, paint, anodizing (not for chrome and zinc plating)
- Maximum, minimum, average and variance values can be calculated automatically

SPECIFICATION

Probe	F500 (included) magnetic induction probe	N1500 (optional) eddy current probe	N2000 (optional) eddy current probe
Measuring range	0~500µm	0~1500µm	0~2000µm
Resolution	0.1µm (range<100µm) 1µm (100µm≤range≤500µm)	0.1µm (range<100µm) 1µm (100µm≤range<1000µm) 0.01mm (1.00mm≤range≤1.50mm)	0.1µm (range<100µm) 1µm (100µm≤range<1000µm) 0.01mm (1.00mm≤range≤2.00mm)
Accuracy*	±(0.5µm+2%L)		
Repeatability*	≤(0.2µm+0.8%L)		≤(0.2µm+1%L)
Measuring mode	single and continuous		
Measuring interval	single mode	1.5s	0.8s
	continuous mode	0.4s	0.4s
Calibration mode	zero calibration and multi-points calibration (1~5 points)		
Minimum substrate thickness	0.1mm	0.05mm	
Minimum measuring area	Ø7mm		Ø25mm
Minimum radius of curvature workpieces	convex surface	1.5mm	
	concave surface	10mm	
Unit	µm/mil		
Power supply	4×1.5V AAA batteries		
Dimension	148×76×26mm		
Weight	148g		

*L is measuring thickness in µm

STANDARD DELIVERY

Main unit	1 pc
Magnetic induction probe	1 pc
Zero calibration plate	1 pc
Calibration foils (5.6µm, 11.6µm, 24.6µm, 50.0µm, 100µm, 252µm, 390µm)	1 set
1.5V AAA battery	4 pcs

OPTIONAL ACCESSORY

Eddy current probe (with zero calibration plate and standard foil)	ISO-8000FN-N1500**
	ISO-8000FN-N2000
Stand	ISO-8000FN-STAND

**For precision measurement of thin coating below 10µm, please use the stand for eddy current probe



POPULAR MODEL

BLUETOOTH

FOR MAGNETIC AND NON-MAGNETIC SUBSTRATES

DATA OUTPUT



COATING THICKNESS GAUGE CODE 9501-1200



eddy current probe **NFE (optional)** with zero calibration block



magnetic induction probe **FE90** for bores and grooves (**optional**)



calibration foils (included)



magnetic induction probe **FE10** for large range (**optional**)



zero calibration block for **FE** (included)



receiver (**optional**)



magnetic induction probe **FE** (included)

- Magnetic induction probe (FE) measures the thickness of non-magnetic coating and non-metallic coating on magnetic metal substrate.
Substrate: iron, steel, magnetic stainless steel (not for non-magnetic stainless steel)
Coating: zinc, copper, chrome, tin, plastic, powder, paint (not for nickel)
- Eddy current probe (NFE) measures the thickness of non-conductive coating on non-magnetic metal substrate.
Substrate: copper, aluminum, zinc, non-magnetic stainless steel
Coating: plastic, powder, paint, anodizing (not for chrome and zinc plating)
- Tolerance measurement
- Data statistic, including average, variance, maximum and minimum values
- Data can be sent to Excel by connecting to computers via bluetooth or cable of receiver
- Support bluetooth printer
- Automatic power off

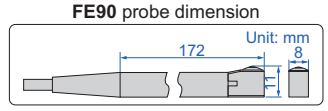

33

SPECIFICATION

Probe type	FE (included) magnetic induction probe	NFE (optional) eddy current probe	FE90 (optional) magnetic induction probe for bores and grooves	FE10 (optional) magnetic induction probe for large range
Measuring range	0~1250µm	0~1250µm	0~1250µm	500~10000µm
Accuracy *	±(3%L+1)µm (range≤1250µm) ±(3%L+10)µm (range>1250µm)			
Resolution	0.1µm (range<100µm) 1µm (range≥100µm)			
Measuring mode	continuous and single			
Minimum substrate thickness	0.5mm	0.3mm	0.5mm	2mm
Minimum measuring area	Ø7mm	Ø15mm	Ø7mm	Ø40mm
Minimum curvature radius of convex workpiece	1.5mm	3mm	—	10mm
Memory	600			
Output	USB			
Power supply	2×1.5V AA batteries			
Dimension	135×77×32mm			
Weight	172g			

* L is measuring thickness in µm

STANDARD DELIVERY

Main unit	1 pc
Magnetic induction probe (FE)	1 pc
Zero calibration block for FE probe	1 pc
Calibration foils (50/100/250/500/1000µm)	1 set
1.5V AA battery	2 pcs
Software and USB cable	1 pc

OPTIONAL ACCESSORY

Receiver	ISR-C300-RECEIVER
Cable of receiver	9501-1200-CABLE
Bluetooth printer	ISR-C002-PRINTER
Eddy current probe (NFE) with zero calibration block	9501-1200-NFE
Magnetic induction probe (FE90) for bores and grooves	9501-1200-FE90
Magnetic induction probe (FE10) for large range	9501-1200-FE10

COATING THICKNESS GAUGE CODE 5401-TC11

TEMPERATURE
COMPENSATION

DATA
OUTPUT



eddy current probe
NM (optional)

- Magnetic induction probe (FM) measures the thickness of non-magnetic coating and non-metallic coating on magnetic metal substrate.
Substrate: steel, iron, alloy, hard magnetic steel, etc.
Coating: zinc, aluminum, chrome, copper, rubber, paint, etc.
- Eddy current probe (NM) measures the thickness of non-conductive coating on non-magnetic metal substrate.
Substrate: copper, aluminum, zinc, tin, etc.
Coating: rubber, paint, plastic, anodized film, etc.
- Real-time temperature compensation guarantees high accuracy, thin plating and oxide layer less than 20µm can be measured accurately
- Reduces the effects of electromagnetic interference and hand-held operation
- Probe can be re-matched after abrasion
- Tolerance measurement with adjustable alarm threshold
- USB interface for data transmission
- Coupling status indication
- Support cable printer



magnetic induction probe
FM (included)

33

SPECIFICATION

Probe		FM (included) magnetic induction probe	NM (optional) eddy current probe
Range		0~1500µm	0~1500µm (chrome plating on copper: 0~40µm)
Resolution		0.1µm (<100µm) 1µm (100µm~1500µm)	
Accuracy*	zero calibration	±(1µm+2%L)	
	one-point calibration	±(1µm+2%L)	
	two-point calibration	±[1µm+(1~2)%L]	
	multi-point calibration	±(1µm+1%L)	
Measuring mode		single point measurement, scan mode, differential mode, average mode	
Calibration mode		zero calibration, one-point calibration, two-point calibration, multi-point calibration	
Test frequency		3 times per second	
Minimum substrate thickness		0.5mm	0.3mm
Minimum measuring area		Ø7mm	Ø5mm
Minimum curvature radius of convex workpiece		1.5mm	3mm
Data storage		500 groups	
Interface		USB	
Operation temperature		-10°C~50°C	
Power supply		3×1.5V AAA batteries	
Dimension		150×70×30mm	
Weight		160g	

* L is the measured value in µm

STANDARD DELIVERY

Main unit	1 pc
Magnetic induction probe (FM)	1 pc
Zero calibration block for FM probe	1 pc
Calibration foils(12/50/100/250/500/1000µm)	6 pcs
AAA battery	3 pcs
Software and USB cable	1 pc

OPTIONAL ACCESSORY

Eddy current probe (NM) (with zero calibration block for NM probe)	5401-TC11-NM
Cable printer	5401-TC11-PRINTER

TEMPERATURE
COMPENSATION

ONLINE MEASUREMENT
IN REAL TIME

BLUETOOTH

COATING THICKNESS GAUGE (ADVANCED TYPE) CODE 5402-TC21



- Magnetic induction probe (FM) measures the thickness of non-magnetic coating and non-metallic coating on magnetic metal substrate.
Substrate: steel, iron, alloy, hard magnetic steel, etc.
Coating: zinc, aluminum, chrome, copper, rubber, paint, etc.
- Eddy current probe (NM) measures the thickness of non-conductive coating on non-magnetic metal substrate.
Substrate: copper, aluminum, zinc, tin, etc.
Coating: rubber, paint, plastic, anodized film, etc.
- Real-time temperature compensation guarantees high accuracy, thin plating and oxide layer less than 20µm can be measured accurately
- Reduces the effects of electromagnetic interference and hand-held operation
- Probe can be re-matched after abrasion
- Tolerance measurement with adjustable alarm threshold
- USB and bluetooth interface for data transmission and online measurement in real-time
- Coupling status indication
- Support cable printer



magnetic
induction probe
FM (included)



mid-range magnetic
induction probe
FL (optional)



high-range magnetic
induction probe
FX (optional)



low-range magnetic
induction probe
FS (optional)



high-temp magnetic
induction probe
FH (optional)



eddy current probe
NM (optional)

SPECIFICATION

Probe	FM (included) magnetic induction probe	FL (optional) mid-range magnetic induction probe	FX (optional) high-range magnetic induction probe	FS (optional) low-range magnetic induction probe	FH (optional) high-temp magnetic induction probe	NM (optional) eddy current probe	
Range	0~1500µm	0~3000µm	0~10000µm	0~500µm	0~3000µm	0~1500µm	
Resolution	0.1µm (<100µm) 1µm (100µm~10000µm)						
Accuracy *	zero calibration	±(1µm+2%L)	±(1µm+3%L)	±(2µm+5%L)	±(1µm+2%L)	±(1µm+3%L)	±(1µm+2%L)
	multi-point calibration	±(1µm+1%L)	±(1µm+2%L)	±(1µm+3%L)	±(1µm+1%L)	±(1µm+2%L)	±(1µm+1%L)
Measuring mode	single point measurement, scan mode, differential mode, average mode						
Calibration mode	zero calibration, one-point calibration, two-point calibration, multi-point calibration						
Minimum substrate thickness	0.5mm	0.5mm	2mm	0.2mm	0.5mm	0.3mm	
Minimum measuring area	Ø7mm	Ø7mm	Ø40mm	Ø3mm	Ø7mm	Ø5mm	
Minimum curvature radius of convex workpiece	1.5mm	1.5mm	10mm	1mm	1.5mm	3mm	
Data storage	500 groups						
Interface	USB, bluetooth						
Operation temperature	-10°C~50°C						
Power supply	3×1.5V AAA batteries						
Dimension	150×70×30mm						
Weight	160g						

* L is the measured value in µm

To be continued

Continued from previous page

STANDARD DELIVERY

Main unit	1 pc
Magnetic induction probe (FM)	1 pc
Zero calibration block for FM probe	1 pc
Calibration foils (12/50/100/250/500/1000µm)	6 pcs
AAA battery	3 pcs
Software and USB cable	1 pc

OPTIONAL ACCESSORY

Eddy current probe (NM) (with zero calibration block for NM probe)	5401-TC11-NM
Mid-range magnetic induction probe (FL)	5402-TC21-FL
High-range magnetic induction probe (FX)	5402-TC21-FX
Low-range magnetic induction probe (FS)	5402-TC21-FS
High-temp magnetic induction probe (FH)	5402-TC21-FH
Cable printer	5401-TC11-PRINTER

**COATING THICKNESS GAUGE (BASIC TYPE)
CODE ISO-1000FN**

FOR MAGNETIC AND
NON-MAGNETIC SUBSTRATES



33

- Probe is suitable for both magnetic and non-magnetic metal substrates
- Can measure the thickness of non-magnetic coating and non-metallic coating on magnetic metal substrate
Substrate: iron, steel, magnetic stainless steel (not for non-magnetic stainless steel)
Coating: zinc, aluminum, copper, chrome, tin, plastic, powder, paint (not for nickel)
- Can measure the thickness of non-conductive coating on non-magnetic metal substrate
Substrate: copper, aluminum, zinc, non-magnetic stainless steel
Coating: plastic, powder, paint, anodizing (not for chrome and zinc plating)
- 3 measuring modes: Fe, NFe, Fe/NFe
- Store 9 measuring records
- Small and portable, easy for operation



ruby contact point

SPECIFICATION

Measuring range	0~5000µm	
Resolution	0.1µm (range<100µm)	
	1µm (100µm≤range<1000µm)	
	0.01mm (1mm≤range≤5mm)	
Accuracy *	<2000µm: ±(2µm+3%L)	
	2000µm~5000µm: ±(2µm+5%L)	
Measure interval	0.5s	
Calibration mode	zero calibration	
Measuring mode	Fe, NFe, Fe/NFe	
Minimum substrate thickness	Fe	0.2mm
	NFe	0.05mm
Minimum measuring area	Ø25mm	
Minimum radius of curvature workpieces	convex surface	5mm
	concave surface	25mm
Unit	µm/mil	
Power supply	2×1.5V AAA batteries	
Dimension	101×62×28mm	
Weight	79g	

* L is the measured value in µm

STANDARD DELIVERY

Main unit	1 pc
Fe zero calibration plate	1 pc
NFe zero calibration plate	1 pc
Standard foil (100µm)	1 pc
1.5V AAA battery	2 pcs



standard foil (included)



Fe zero calibration plate (included)



NFe zero calibration plate (included)



FOR MAGNETIC AND
NON-MAGNETIC SUBSTRATES

COATING THICKNESS GAUGE (BASIC TYPE) CODE ISO-1200FN

- Probe is suitable for both magnetic and non-magnetic metal substrates
- Can measure the thickness of non-magnetic coating and non-metallic coating on magnetic metal substrate
Substrate: iron, steel, magnetic stainless steel (not for non-magnetic stainless steel)
Coating: zinc, aluminum, copper, chrome, tin, plastic, powder, paint (not for nickel)
- Can measure the thickness of non-conductive coating on non-magnetic metal substrate
Substrate: copper, aluminum, zinc, non-magnetic stainless steel
Coating: plastic, powder, paint, anodizing (not for chrome and zinc plating)
- 3 measuring modes: Fe, NFe, Fe/NFe
- Store 9 measuring records
- Small and portable, easy for operation



ruby contact point

33

SPECIFICATION

Measuring range	0~5000μm	
Resolution	0.1μm (range<100μm) 1μm (100μm≤range<1000μm) 0.01mm (1mm≤range≤5mm)	
Accuracy *	<2000μm: ±(2μm+3%L) 2000μm~5000μm: ±(2μm+5%L)	
Measure interval	0.5s	
Calibration mode	zero calibration	
Measuring mode	Fe, NFe, Fe/NFe	
Minimum substrate thickness	Fe	0.2mm
	NFe	0.05mm
Minimum measuring area	Ø25mm	
Minimum radius of curvature workpieces	convex surface	5mm
	concave surface	25mm
Unit	μm/mil	
Power supply	2×1.5V AAA batteries	
Main unit dimension	101×62×28mm	
Probe dimension	71×26×22mm	
Weight	114g	

* L is the measured value in μm



Fe zero calibration plate
(included)



NFe zero calibration plate
(included)



standard foil (included)

STANDARD DELIVERY

Main unit	1 pc
Fe zero calibration plate	1 pc
NFe zero calibration plate	1 pc
Standard foil (100μm)	1 pc
1.5V AAA battery	2 pcs

COATING THICKNESS GAUGE CODE 5403-QM32



FOR INDOOR OR OUTDOOR
LOW TEMPERATURE USE

BLUETOOTH



ruby probe

- Suitable for both magnetic and non-magnetic metal substrates
- Can measure the thickness of non-magnetic coating and non-metallic coating on magnetic metal substrate
Substrate: iron, steel, magnetic stainless steel
Coating: zinc, aluminum, copper, chrome, tin, plastic, powder, paint (not for nickel)
- Can measure the thickness of non-conductive coating on non-magnetic metal substrate
Substrate: copper, aluminum, zinc, non-magnetic stainless steel
Coating: plastic, powder, paint, anodizing (not for chrome and zinc plating)
- Can quickly detect the paint thickness of iron and aluminum body of car, three colors of backlight indication, can identify non-metal shell and iron powder putty layer
- Can connect to mobile APP, measure and generate test reports in real time, and save or share the report
- Built-in multiple languages
- Store 9 measuring records
- Small and portable, easy for operation

33

car body paint thickness detection

<p>53.0 μm AUTO Fe</p> <p>paint thickness < 170 μm, blue backlight indicates "normal thick"</p>	<p>255.1 μm AUTO Fe</p> <p>paint thickness between 170 μm and 350 μm, yellow backlight indicates "slightly thick"</p>	<p>503.4 μm AUTO Fe</p> <p>paint thickness > 350 μm, red backlight indicates "ultra thick"</p>
--	---	---

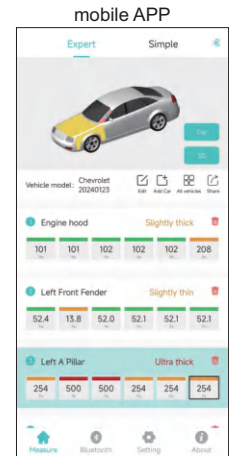

SPECIFICATION

Measuring range	0~3000 μm
Resolution	0.1 μm (range < 100 μm) 1 μm (100 μm ≤ range < 1000 μm) 0.01 mm (1 mm ≤ range < 3 mm)
Accuracy	±(2 μm + 3%L) L is measuring thickness in μm
Measure interval	0.5s
Calibration mode	zero calibration
Display	LCD
Working temperature	-20~50 °C
Unit	μm/mil
Language	Chinese, English, Turkish, Ukrainian
Power supply	2×1.5V AAA batteries
Dimension	100×60×24 mm
Weight	80g

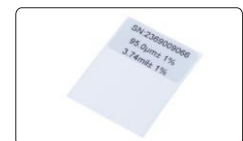

standard foil (included)



Fe zero calibration plate (included)



NFe zero calibration plate (included)

STANDARD DELIVERY

Main unit	1 pc
Fe zero calibration plate	1 pc
NFe zero calibration plate	1 pc
Standard foil (100 μm)	1 pc
1.5V AAA battery	2 pcs



FOR INDOOR OR OUTDOOR
LOW TEMPERATURE USE

BLUETOOTH

DOUBLE SCREEN COATING THICKNESS GAUGE CODE 5404-QM42

- Probe is suitable for both magnetic and non-magnetic metal substrates
- Can measure the thickness of non-magnetic coating and non-metallic coating on magnetic metal substrate
Substrate: iron, steel, magnetic stainless steel
Coating: zinc, aluminum, copper, chrome, tin, plastic, powder, paint (not for nickel)
- Can measure the thickness of non-conductive coating on non-magnetic metal substrate
Substrate: copper, aluminum, zinc, non-magnetic stainless steel
Coating: plastic, powder, paint, anodizing (not for chrome and zinc plating)
- Can quickly detect the paint thickness of iron and aluminum body of car, three colors of backlight indication, can identify non-metal shell and iron powder putty layer
- Can connect to mobile APP, measure and generate test reports in real time, and save or share reports
- Double screen, easy reading and normal use at -40°C low temperature
- Built-in multiple languages
- Store 9 measuring records
- Small and portable, easy for operation



ruby probe

car body paint thickness detection

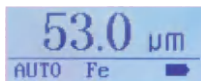

paint thickness $< 170\mu\text{m}$,
blue backlight indicates
"normal thick"

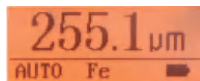

paint thickness between
 $170\mu\text{m}$ and $350\mu\text{m}$, yellow
backlight indicates "slightly thick"



paint thickness $> 350\mu\text{m}$,
red backlight indicates
"ultra thick"



OLED screen

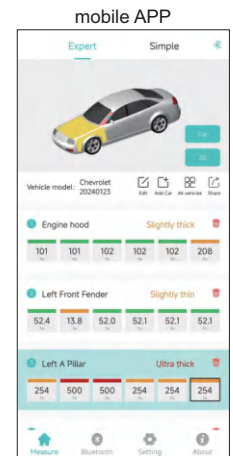

SPECIFICATION

Measuring range	0~3000 μm
Resolution	0.1 μm (range $< 100\mu\text{m}$) 1 μm ($100\mu\text{m} \leq \text{range} < 1000\mu\text{m}$) 0.01mm ($1\text{mm} \leq \text{range} < 3\text{mm}$)
Accuracy	$\pm(2\mu\text{m}+3\%L)$ L is measuring thickness in μm
Measure interval	0.5s
Calibration mode	zero calibration
Display	front screen LCD, top screen OLED
Working temperature	$-20\sim 50^{\circ}\text{C}$ (LCD screen), $-40\sim 50^{\circ}\text{C}$ (OLED screen)
Unit	$\mu\text{m}/\text{mil}$
Language	Chinese, English, Turkish, Ukrainian
Power supply	2 \times 1.5V AAA batteries
Dimension	100 \times 60 \times 24mm
Weight	80g



standard foil (included)



Fe zero calibration plate (included)



NFe zero calibration plate (included)

STANDARD DELIVERY

Main unit	1 pc
Fe zero calibration plate	1 pc
NFe zero calibration plate	1 pc
Standard foil (100 μm)	1 pc
1.5V AAA battery	2 pcs

CALIBRATION FOILS FOR COATING THICKNESS GAUGES



- To calibrate or check the accuracy of coating thickness gauges
- Increase the measurement accuracy after foil calibration
- Uniformity: $\pm 0.3\mu\text{m}$ ($\leq 50\mu\text{m}$), $\pm 0.6\%$ ($> 50\mu\text{m}$)
- Dimension: $45 \times 30\text{mm}$ (thickness $\leq 2000\mu\text{m}$), $50 \times 30\text{mm}$ (thickness $> 2000\mu\text{m}$)
- Supplied with manufacturer inspection certificate

Code	Thickness	Deviation *	Uniformity
9503-FL1	11.5 μm	$\pm 5\%$	$\pm 0.3\mu\text{m}$
9503-FL2	23 μm	$\pm 5\%$	$\pm 0.3\mu\text{m}$
9503-FL3	50.5 μm	$\pm 5\%$	$\pm 0.6\%$
9503-FL4	102 μm	$\pm 5\%$	$\pm 0.6\%$
9503-FL5	250 μm	$\pm 5\%$	$\pm 0.6\%$
9503-FL6	495 μm	$\pm 3\%$	$\pm 0.6\%$
9503-FL7	995 μm	$\pm 2\%$	$\pm 0.6\%$
9503-FL8	1780 μm	$\pm 5\%$	$\pm 0.6\%$
9503-FL9	3725 μm	$\pm 4\%$	$\pm 0.6\%$
9503-FL10	7650 μm	$\pm 2\%$	$\pm 0.6\%$
9503-FL11	780 μm	$\pm 5\%$	$\pm 0.6\%$
9503-FL12	1400 μm	$\pm 3\%$	$\pm 0.6\%$

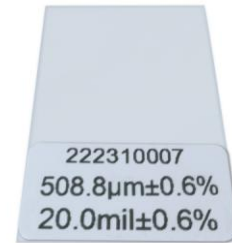

9503-FL6

* Deviation between the ordered thickness and the thickness marked on the calibration foils when supplied

33

X-RAY FLUORESCENCE SPECTROMETER (RoHS DETECTOR/ALLOY ANALYZER /PLATING THICKNESS INSTRUMENT) CODE XRF-B210

REFER TO PAGE
932-933 FOR DETAILS



X-RAY FLUORESCENCE SPECTROMETER/PLATING THICKNESS INSTRUMENT (ADVANCED TYPE) CODE XRF-PT230

REFER TO PAGE
931 FOR DETAILS



SURFACE PROFILE GAUGE

measure peak-to-valley height of blast cleaned surfaces

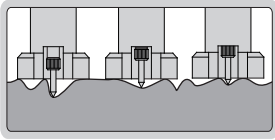

2344-1

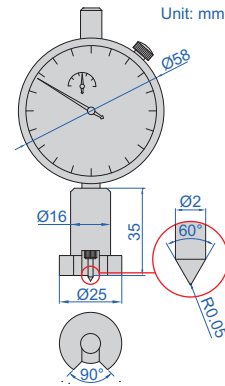

VIDEO

- Measure peak-to-valley height of blast cleaned surface. If the profile is too low, the adhesion of the coating to the surface will be reduced. If the profile is too high, there is the danger that the profile peaks will remain uncoated, allowing rust spots to occur.
- Meet ASTM D 4417-B
- Zero set block is included, set zero before measurement
- Stainless steel base

Code	Range	Dial indicator stroke	Dial indicator graduation	Accuracy
2344-1	0-1mm	1mm	0.001mm	±0.005mm

set zero



zero set block (included)

33

DIGITAL SURFACE PROFILE GAUGE

measure peak-to-valley height of blast cleaned surfaces

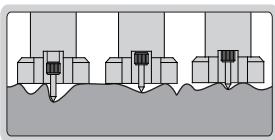

2843-10

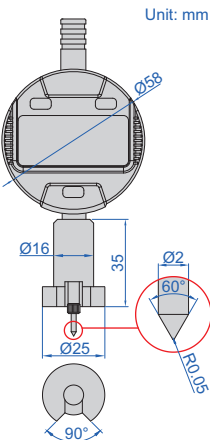

DATA OUTPUT



VIDEO

- Measure peak-to-valley height of blast cleaned surface. If the profile is too low, the adhesion of the coating to the surface will be reduced. If the profile is too high, there is the danger that the profile peaks will remain uncoated, allowing rust spots to occur.
- Meet ASTM D 4417-B
- Zero set block is included, set zero before measurement
- Button function: on/off, zero, mm/inch, absolute/incremental measurement
- CR2032 battery, automatic power off (time is adjustable)
- Data output
- Stainless steel base
- Optional accessory: wireless transmitter code **7315-50M** (receiver is needed) page 6, bluetooth transmitter code **7214-50M** page 12, data output cable code **7302-40M** page 21

Code	Range	Digital indicator stroke	Digital indicator resolution	Accuracy
2843-10	0-12.7mm/0-0.5"	12.7mm/0.5"	0.001mm/0.00005"	±0.005mm

set zero



zero set block (included)

DIGITAL SURFACE PROFILE GAUGE



DATA
OUTPUT

DISPLAY MAXIMUM, MINIMUM, DIFFERENCE
VALUE BETWEEN MAXIMUM AND MINIMUM

measure peak-to-valley height
of blast cleaned surfaces

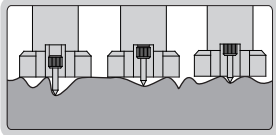

2844-10

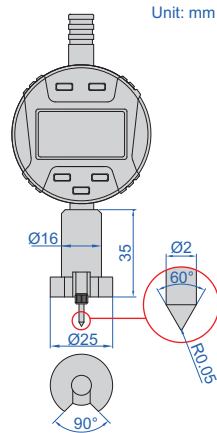

33

- Measure peak-to-valley height of blast cleaned surface.
If the profile is too low, the adhesion of the coating to the surface will be reduced.
If the profile is too high, there is the danger that the profile peaks will remain uncoated, allowing rust spots to occur.
- Meet ASTM D 4417-B
- Zero set block is included, set zero before measurement
- Button function: tolerance Go and No-Go display, data preset, measuring direction change, max./min./TIR measurement, inch/metric conversion, absolute/incremental measurement
- CR2032 battery
- Automatic power off (time is adjustable)
- Data output
- Stainless steel base
- Optional accessory:
wireless transmitter code **7315-50M** (receiver is needed) page 6,
bluetooth transmitter code **7214-50M** page 12,
data output cable code **7302-40M** page 21

Code	Range	Digital indicator stroke	Digital indicator resolution	Accuracy
2844-10	0-12.7mm/0-0.5"	12.7mm/0.5"	0.001mm/0.00005"	±0.005mm



WET FILM GAUGES

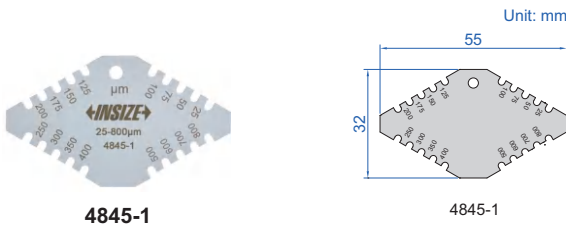

4845-1

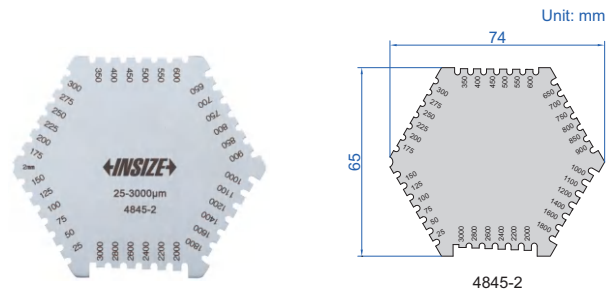

4845-2

- Made of stainless steel

Code	Range	Accuracy	Thickness
4845-1	25-800µm	±5µm	1.8mm
4845-2	25-3000µm	25-100µm: ±5µm 100µm-3000µm: ±5%	1mm



DATA
OUTPUT

GLOSS METERS

- According to JIG 696, ISO 2813, ASTM D2457, ASTM D523, GB/T 9754
- To measure the gloss level of material surfaces such as paint, wood, stone, plastic, paper, leather, metal, etc.
- Automatic judgement after setting high and low limits
- Automatic power off

SPECIFICATION

Code	5702-DG6	5702-DG8
Measuring angle	60°	20°, 60°, 85°
Measuring range	0~200GU	20°: 0~2000GU, 60°: 0~1000GU, 85°: 0~160GU
Measuring spot	9mm×15mm	20°: 9mm×9mm, 60°: 9mm×15mm, 85°: 5mm×38mm
Minimum measurement size	20mm×10mm	57mm×10mm
Accuracy	0~100GU: ±1.5GU 100~200GU: ±1.5%	0~100GU: ±1.5GU 100~2000GU: ±1.5%
Repeatability	0~100GU: 0.2GU 100~200GU: 0.2%	0~100GU: 0.2GU 100~2000GU: 0.2%
Resolution	0.1GU	
Zero value error	0.1GU	
Data port	USB (Type-C)	
Power supply	3.7V rechargeable Li-ion battery	
Dimension	135×45×75mm	
Weight	237g	



5702-DG8

base with calibration block
(included)



software (included), test can be controlled from
the software, display test data and report

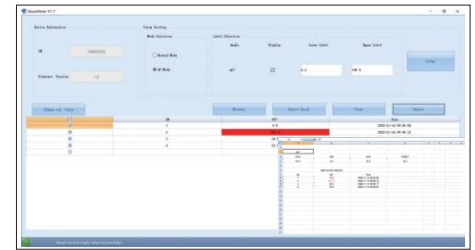

STANDARD DELIVERY

Main unit	1 pc
Base with calibration block	1 pc
U disk	1 pc
AC/DC adapter	1 pc
USB data cable	1 pc



- To test the gloss of coating, such as painting, varnish, printing ink, etc.
- To test the material surfaces, such as metal, granite, ceramic, plastic, paper, etc.
- According to ISO 2813, ASTM D2457, ASTM D523
- Automatic power off

SPECIFICATION

Incidence angle	60°
Measuring range	0~150GU
Resolution	0.1GU
Accuracy	±1.2GU
Repeatability	0.4GU
Zero set error	0.2GU
Measuring area	20×10mm
Output	bluetooth
Power supply	1×1.5V AA battery
Dimension	123×38×65mm
Weight	300g

STANDARD DELIVERY

Main unit	1 pc
Base with calibration block	1 pc
Spare calibration block	1 pc

60° GLOSS METER CODE ISQ-DG6



base with calibration block
(included)



connect mobile phone via bluetooth
(only Android system)



MICROPOROUS GLOSS METER (BASIC TYPE) CODE 5712-SG60

CAN BE OPERATED BY
COMPUTERS OR MOBILE PHONES

DATA
OUTPUT

BLUETOOTH

SPOT SIZE
1.5×3mm

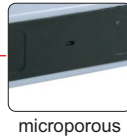

connect to mobile phone via Bluetooth
(only Android system)



connect to computer via Bluetooth

Bluetooth receiver
(included)



- According to ISO 2813, ASTM D2457, ASTM D523, GB/T 9754
- For measuring the gloss level of small and curved surfaces
- To measure the gloss level of material surfaces such as paint, wood, stone, plastic, paper, leather, metal, etc.
- Automatic power off

SPECIFICATION

Measuring angle	60°
Measuring range	0~199.9GU
Resolution	0.1GU
Accuracy	±1.5GU
Zero value error	±0.2GU
Repeatability	±0.4GU
Measuring spot	1.5mm×3mm
Minimum measurement size	2mm×4mm
Data output	Bluetooth
Software support	Windows, Android
Power supply	1×1.5AA battery
Dimension	123×65×38mm
Weight	300g

STANDARD DELIVERY

Main unit	1 pc
Base with calibration block	1 pc
USB flash disk	1 pc
Bluetooth receiver	1 pc

software (included), test can be controlled from the software

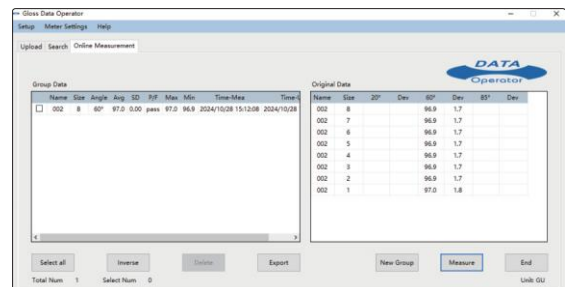

DATA OUTPUT

QUALITY INSPECTION

SPOT SIZE 1.5*3mm

MICROPOROUS GLOSS METER (ADVANCED TYPE) CODE 5711-SG60

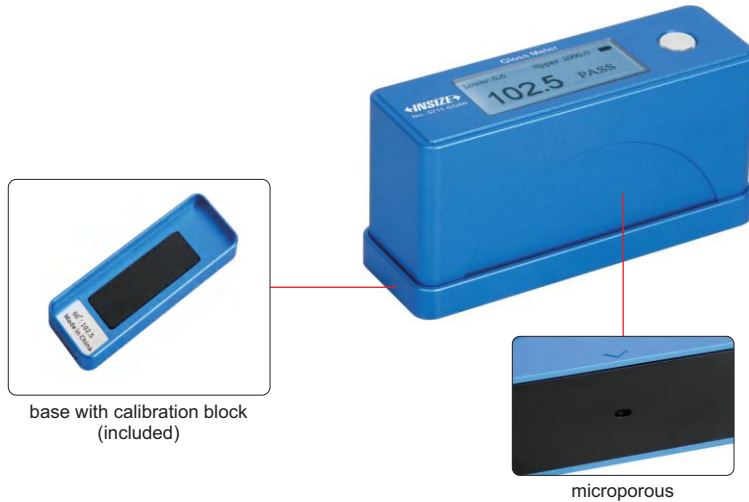

base with calibration block (included)

microporous

- According to ISO 2813, ASTM D2457, ASTM D523, GB/T 9754
- For measuring the gloss level of small and curved surfaces up to 1000GU
- To measure the gloss level of material surfaces such as paint, wood, stone, plastic, paper, leather, metal, etc.
- The normal mode is for immediate measurement and fast readings, the quality control mode with customizable upper and lower limits is for rapid incoming inspection
- Self-contained calibration board with freely definable calibration values



connect to computer via USB cable

SPECIFICATION

Measuring angle	60°
Measuring range	0~1000GU
Resolution	0.1GU
Accuracy	0~100GU: ±1.5GU 100~1000GU: ±1.5%
Zero value error	±0.2GU
Repeatability	0~100GU: ±0.2GU 100~1000GU: ±0.2%
Measuring spot	1.5mm×3mm
Minimum measurement size	3mm×6mm
Data output	USB (Type-C)
Software support	Windows
Power supply	Li-ion battery, 3.7V
Dimension	102×35×51mm
Weight	300g

software (included), test can be controlled from the software

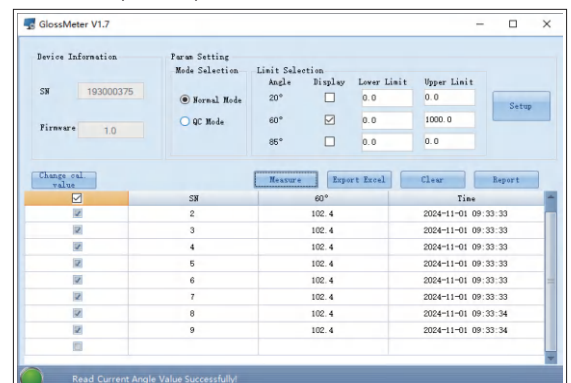

STANDARD DELIVERY

Main unit	1 pc
Base with calibration block	1 pc
USB flash disk	1 pc
Data cable	1 pc

20°/60°/85° GLOSS METER CODE ISQ-DG8

DATA
OUTPUT

BLUETOOTH

CAN BE OPERATED BY
COMPUTERS OR MOBILE PHONES



software flash disk
(included)



connect to mobile phone via bluetooth
(only Android system)



operate and output data by mobile phone



base with calibration block
(included)

connect to computer via bluetooth or USB cable

bluetooth receiver
(included)



- To test the gloss of coating, such as painting, varnish, printing ink, etc.
- To test the material surfaces, such as metal, granite, ceramic, plastic, paper, etc.
- According to ISO 2813, ASTM D2457, ASTM D523
- Memory of 10000 measurement results for browsing and output
- Automatic power off

SPECIFICATION

Incidence angle	20°	60°	85°
Measuring range	0~2000GU	0~1000GU	0~160GU
Resolution	0.1GU (range≤119.9GU) 1GU (range>119.9GU)		
Accuracy	±1.5GU (range≤119.9GU) ±1.5% (range>119.9GU)		
Repeatability	0.2GU (range≤119.9GU) 0.2% (range>119.9GU)		
Zero set error	0.2GU		
Measuring area	10×9mm	16×9mm	39×5mm
Output	USB and bluetooth		
Power supply	1×1.5V AA battery		
Dimension	155×48×75mm		
Weight	400g		

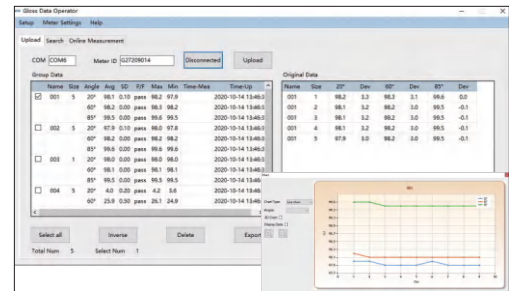

software (included), test can be controlled from the software,
display test data, output to Excel

STANDARD DELIVERY

Main unit	1 pc
Base with calibration block	1 pc
Software and USB cable	1 pc
Bluetooth receiver	1 pc

GLOSS PLATES

- Used to calibrate work gloss meters
- The high gloss plates are made of polished black glass or other materials.
The medium and low glossplates are made of ceramic

CUSTOMIZED

SPECIFICATION

Code	5721-LGU	5721-MGU	5721-HGU
Gloss range	low gloss	medium gloss	high gloss
Incidence angle*	20°, 45°, 60°, 75°, 85°		
Material	polished black glass, ceramic, mirror reflective glass etc.		
Flatness (black glass plate)	interference aperture ≤15, partial aperture ≤3		
Spectrum reflection neutral error (ceramic plate)	±12%		
Annual variation	±1GU		
Environment	temperature 5~45°C, relative humidity <85%RH		
Dimension	80×50×11mm		
Weight	according to different materials		



5721-LGU

* Different incidence angles are available according to customer requirements

HOLIDAY DETECTOR CODE 9511-HA30



strip brush (included)

- Inspect anti-corrosion coating status of different thickness with adjustable pulse high-voltage, coating includes insulating paint, glass lining, rubber lining, glass fiber reinforced plastic, coal tar epoxy, etc.
- When the brush with pulse high-voltage moves near the crack, pinhole or thin area on the coating surface, which results in gap gas breakdown and discharge spark, sound and light alarm will appear on the probe and the alarm sound can be heard with the headphone
- LCD display with light-control backlight
- Built-in rechargeable battery, easy to carry and suitable for outdoor inspection
- Automatic power off



headphone (included)



flat brush (included)

SPECIFICATION

Measuring range	0.05~10mm (customization for inspecting coating thicker than 10mm is available)
Output voltage	0.6~30.0kV (stepless adjustable)
Resolution	0.1kV
Power	≤5W
Power supply	12V rechargeable Ni-MH battery
Dimension	220×130×88mm
Weight	2.5kg

STANDARD DELIVERY

Main unit	1 pc
Probe	1 pc
Strip brush*	1 pc
Flat brush	1 pc
Ground wire	1 pc
Ground rod	1 pc
Headphone	1 pc
AC/DC adapter	1 pc

* Arc brush and circular probe can be customized

SPECTROPHOTOMETER SELECTION TABLE

Code	5700-LS35	5701-D40	9710-30	5707-DS78	5701-D45	5705-MS45	5706-DS01
Optical geometry *	d/8	d/8	d/8	d/8	45/0	15°, 25°, 45°, 75°, 110°	d/8
Observer angle	2°	2°/10°	2°/10°	2°/10°	2°/10°	2°/10°	2°/10°
Minimum measurement size	Ø8mm	1×3mm	Ø4mm	Ø3mm	1×3mm	Ø12mm	Ø3mm
Repeatability (ΔE*ab)	≤0.03	≤0.025	≤0.03	≤0.01	≤0.025	≤0.03	≤0.015
Portable	√	√	√	√	√	√	
Apertures switching		√	√	√	√		√
Multi illumination		√	√	√	√	√	√
Specular component include	√	√	√	√			√
Specular component exclude		√	√	√			√
Data output		USB Bluetooth	USB	USB Bluetooth	USB Bluetooth	USB	USB

* d/8 the sample is diffusely illuminated by the integrating sphere, receive reflected light at 8° to the sample normal
45/0 illuminate the sample with the light source at 45° to the sample normal, receive reflected light in the normal direction

SPECTROPHOTOMETER CODE 5706-DS01



33

- Highly stable UV source for stable fluorescence measurements
- Grating spectroscopy, 7" IPS touch screen
- Two types of light sources: pulsed lamp and LED, can measure SCI and SCE simultaneously and quickly
- 24 standard light sources, more than 40 measurement indicators
- Temperature and humidity compensation function

SPECIFICATION

Optical geometry	reflect: D/8 (diffused illumination, 8° direction reception), transmission: D/0 (diffused illumination, vertical reception), SCI (specular reflective light included), SCE (specular reflective light not included)
Integrating sphere diameter	Ø152mm
Light source	pulsed xenon lamp and LED
Spectrophotometric mode	concave grating
Sensor	double array CMOS image sensor
Wavelength range	360nm~780nm
Wavelength interval	10nm
Reflectance measuring range	0~200%
Reflectance resolution	0.01%
Transmission measurement	width and height unlimited, thickness≤50mm
Measuring aperture	reflect: XLAV Ø25.4mm/Ø30mm, LAV Ø15mm/Ø18mm, MAV Ø8mm/Ø11mm, SAV Ø3mm/Ø6mm transmission: Ø17mm/Ø25mm
Color space	L*a*b, L*C*h, Hunter Lab, Yxy, XYZ
Color difference formula	ΔE^*ab , ΔE^*CH , ΔE^*uv , ΔE^*cmc , ΔE^*94 , ΔE^*00 , ΔEab (Hunter), 555 color classification
Colorimetric index	WI (ASTM E313-00, ASTM E313-73, CIE/ISO, AATCC, Hunter, Taube, Berger Stensby), YI (ASTM D1925, ASTM E313-00, ASTM E313-73), Tint (ASTM E313-00), metamerism index Milm, staining fastness, color fastness, ISO luminance, R457, A density, T density, Edensity, M density, APHA/Hazen/Pt-Co, Gardner, Saybolt, Astm color, haze, total transmittance, coverage, power, strength
Observer angle	2°/10°
Illuminant	A, C, D50, D55, D65, D75, F1, F2, F3, F4, F5, F6, F7, F8, F9, F10, F11, F12, CWF, U30, DLF, NBF, TL83, TL84
Measuring time	SCI or SCE <2 seconds, SCI and SCE simultaneous measuring <4 seconds
Repeatability*	$\Delta E^*ab \leq 0.015$; reflect / transmittance $\leq 0.1\%$
Inter-instrument error	XLAV $\Delta E^*ab \leq 0.25$ (based on average of 12 swatches of BCRA series at 23°C)
Data port	RS232, USB, USB-B
Power supply	power adapter (24V/2.5A)
Dimension	465×240×260mm
Weight	10.8kg

* After calibration, measure the white plate for 30 times at 5-second intervals with XLAV aperture, the standard deviation of the measurement results.

To be continued

Continued from previous page

software (included), can control the test by software, display test data and generate reports



connect to computer

upward measurement

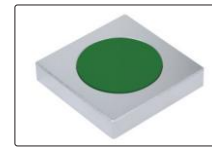
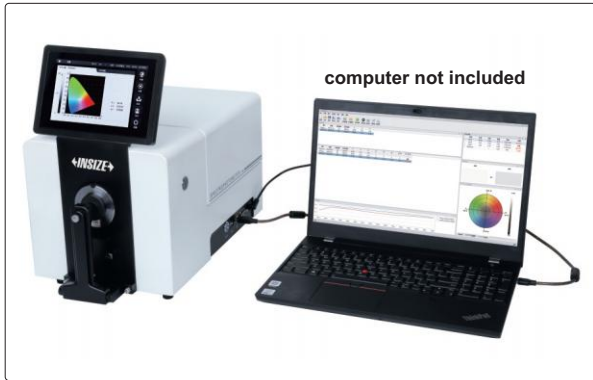

green plate (included)

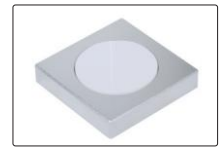

white plate (included)



black cavity (included)



cuvette (included)

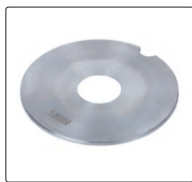

measuring aperture (included)



heated transmission clamp (optional)



small sample fixture (optional)



protective plate (optional)



vertical stand (optional)



cuvette support (optional)



fiber test holder (optional)

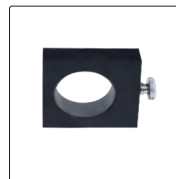

film test clamp (optional)

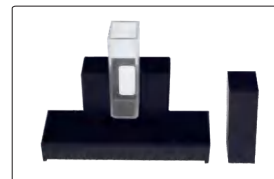

microtransmission clamp (optional)

STANDARD DELIVERY

Main unit	1 pc
Black cavity	1 pc
White plate	1 pc
Green plate	1 pc
Measuring aperture	4 pcs
Cuvette	1 pc
USB flash disk	1 pc
Data cable	2 pcs
Damping handle	1 pc
Support platform	1 pc
Transmission fixture	1 pc
Power adapter	1 pc

OPTIONAL ACCESSORY

Heated transmission clamp	5706-DS01-CLAMP1
Small sample fixture	5706-DS01-FIXTURE
Cuvette support	5706-DS01-SUPPORT
Vertical stand	5706-DS01-STAND
Protective plate	5706-DS01-PLATE
Fiber test holder	5706-DS01-HOLDER
Microtransmission clamp	5706-DS01-CLAMP2
Film test clamp	5706-DS01-CLAMP3

MULTI-ANGLE SPECTROPHOTOMETER CODE 5705-MS45

CONCAVE GRATING
SPECTROPHOTOMETRIC

DATA
OUTPUT

BLUETOOTH



Angle	Y:	x:	y:	RGB
15°	60.46	0.44008	0.46548	
25°	60.37	0.44016	0.46573	
45°	60.24	0.44020	0.46593	
75°	60.10	0.44117	0.46719	
110°	56.18	0.44302	0.46659	

specimen recording interface

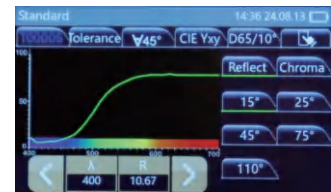

specimen reflectance
recording interface

33

- Adopt 5 illumination sources, 1 receiver to measure 5 measurement angles at the same time
- Touch screen can display all angle measurement results, more intuitive view of the comprehensive data
- Full spectrum illumination measurement is more professional to avoid spectrum loss
- Provide 6 color spaces, multiple observation light sources
- Using concave grating spectrophotometric technology, with higher resolution, makes color measurement more accurate
- Built-in color camera positioning, can accurately judge the object measured position, and improve the measurement efficiency and accuracy
- Multiple functions, the screen can display various data intuitively



black light trap
(included)



white board
(included)



bluetooth receiver
(included)



wireless printer
(optional)



wired printer
(optional)

STANDARD DELIVERY

Main unit	1 pc
Black light trap	1 pc
White board	1 pc
Software and USB cable	1 pc
Power adapter	1 pc
Bluetooth receiver	1 pc

OPTIONAL ACCESSORY

Wired printer	5705-MS45-PRINTER-A
Wireless printer	5705-MS45-PRINTER-B

To be continued

Continued from previous page

SPECIFICATION

Measurement geometry	5 measurement angles (5 illumination sources, 1 receiver)
Measuring angle	45° receiver: 45as15°, 45as25°, 45as45°, 45as75°, 45as110°
Lighting source	full spectrum LED light source with blue enhancement
Lamp life	5 years, 3 million times measurements
Spectrophotometric mode	concave grating
Sensor	256 image element double array CMOS image sensor
Wavelength range	400nm~700nm
Wavelength interval	10nm
Measurement range	0~600%
Semiband width	10nm
Measuring aperture	illuminant Ø23mm/sampling Ø12mm
Color space	CIE LAB, XYZ, Yxy, Lch, βxy, DIN Lab99
Color difference formula	ΔE^*ab , ΔE^*94 , ΔE^*cmc (2: 1), ΔE^*cmc (1: 1), ΔE^*00 , DIN $\Delta E99$, ΔE DIN6175
Other colorimetric index	flop index
Observer angle	2°/10°
Illuminant	D65, A, C, D50, D55, D75, F1, F2 (CWF), F3, F4, F5, F6, F7 (DLF), F8, F9, F10 (TPL5), F11 (TL84), F12 (TL83/U30)
Measuring time	approx, 1 second for one angle, approx, 5 seconds for all angles
Repeatability	spectral reflectance: standard deviation within 0.08% chromaticity value: ΔE^*ab 0.03 (when a white calibration plate is measured 30 times at 5 second intervals after white calibration)
Reproducibility	$\Delta E^* < 0.10$, avg on the gray tile of BCRA tile set, $\Delta E^* < 0.25$, avg on the color BCRA tile set
Spectrophotometric mode	0.2 ΔE^*00 (avg on reference series II BCRA tile set)
Trigger mode	pressure sensing, trigger, key trigger, software trigger
Measuring mode	single measurement, average measurement (1~99), continuous measurement (1~99)
Locating method	color camera preview
Power supply	Li-ion battery, 3.7V, 3200mAh, continuous test 6000 times within 8 hours of full charge
Display screen	3.5-inch TFT color LCD, capacitive touch screen
Interface	USB, bluetooth 5.0
Data storage	standard 1000 pcs, sample 4000 pcs
Calibration	built-in white board parameters, external white board, black light trap
Calibration interval	4 hours, 8 hours, 24 hours, startup calibration
Dimension	195×83×128mm
Weight	1kg

FOUR APERTURES SWITCHING



BLUETOOTH

DATA OUTPUT

PORTABLE SPECTROPHOTOMETER (EXCELLENT TYPE) CODE 5707-DS78

- The wavelength range of conventional spectrophotometer is 400~700nm, for more accurate colour measurement, the wavelength of this spectrophotometer is extended to 360~780nm
- Xenon lamp and LED light system for longer than expected life
- Four aperture sizes can be switched at will, allowing for easy measurement of even the smallest objects or curved samples
- Automatic wavelength accuracy correction using reference grade BCRA green boards
- No need to manually calibrate, just put it on the calibration base, the instrument will be automatically calibrated according to its own state and environmental factors, to ensure that the instrument is always in a stable state
- Built-in colour camera to take the view of the positioning, accurate determination of the object to be measured part
- Single measurement, continuous uninterrupted measurement, averaging possible



calibration cavity (included)

To be continued

Continued from previous page

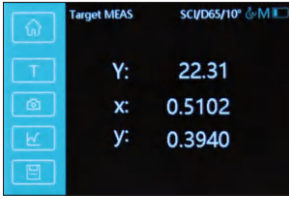

specimen measurement interface

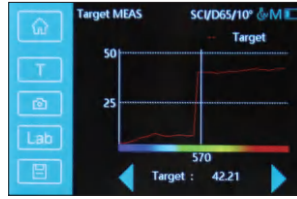

specimen reflectance measurement interface

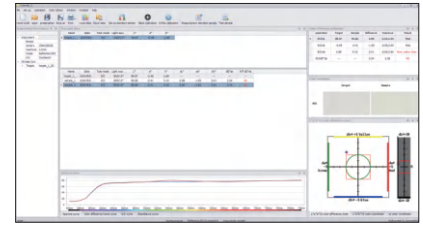

software (included), test can be controlled from the software, display test data

SPECIFICATION

Optical geometry	D/8 (diffused illumination/8° direction reception) SCI+SCE (specular component included+specular component excluded)
Integrating sphere size	Ø40mm
Lighting source	full-band balanced LED + xenon lamp
Sensor	dual-row high-precision CMOS image sensor
Calibration mode	BCRA certified black and white board energy calibration, green board wavelength accuracy calibration
Spectrophotometric mode	grating
Display accuracy	0.01
Light source lifetime	10 million times measurements
Wavelength range	360nm~780nm
Wavelength interval	10nm
Measurement range	0-200%
Reflectance resolution	0.01%
Measuring aperture	Ø11mm, Ø10mm, Ø6mm, Ø3mm
Repeatability	0.01 ΔE*ab (after instrument calibration, the white board was measured 30 times at 5s intervals with the MAV calibre)
Inter-instrument error	0.2 ΔE*ab (BCRA series II 12 colour plates MAV calibre measurement average)
Observer angle	2°/10°
Colorimetric index	spectral reflectivity, CIE-Lab, CIE-LCh, HunterLab, CIE-Luv, XYZ, Yxy, RGB (ΔE*ab, ΔE*cmc, ΔE*94, ΔE*00), Whiteness (ASTM E313-00, ASTM E313-73, CIE, ISO2470/R457, AATCC, Hunter, Taube Berger Stensby), Yellowness (ASTM D1925, ASTM E313-00, ASTM E313-73), Blackness (My, dM), Strength, Fastness, Tint (ASTM E313-00), CMYK (A, T, E, M), Milm, Munsell, Opacity, Color strength
Illumination	A, B, C, D50, D55, D65, D75, F1, F2, F3, F4, F5, F6, F7, F8, F9, F10, F11, F12, CWF, U30, U35, DLF, NBF, TL83, TL84, ID50, ID65, LED-B1, LED-B2, LED-B3, LED-B4, LED-B5, LED-BH1, LED-RGB1, LED-V1, LED-V2
Measuring time	1s
Data storage	instrument: 10000pcs, app: mass storage
Locating method	color camera preview
Display screen	3.5-inch full-colour screen, capacitive touch screen
Interface	USB, bluetooth
Calibration	automatic intelligent calibration
Software support	Andriod, iOS, Windows
Power supply	Li-ion battery, 7.2V, 3000mAh, fully charged continuous test 8000 times
Dimension	233×77×93mm
Weight	600g

STANDARD DELIVERY

Main unit	1 pc
Calibration cavity	1 pc
Software and USB cable	1 pc
Measuring aperture	4 pcs
Power adapter	1 pc

PORTABLE SPECTROPHOTOMETER (ADVANCED TYPE) CODE 9710-30

DATA OUTPUT BLUETOOTH

Ø8/4mm DUAL APERTURE

CONCAVE GRATING SPECTROPHOTOMETRIC

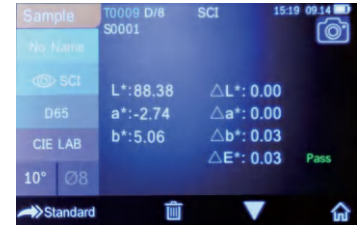

measurement



software flash disk (included)



white and black calibration cavity (included)



printer (optional)



reflectivity

- Concave grating spectrophotometric
- 3.5 inch TFT color LCD, capacitive touch screen, 256 image element double arrays CMOS image sensor
- D/8 geometrical optics, conforms with CIE No.15, ISO7724/1, ASTM E1164, DIN5033 Teil 7
- Use long life and low power consumption combined LED light source
- Camera locating function, switchable 8mm/4mm aperture, support both SCI and SCE at the same time
- Large capacity storage space, over 20,000 measurement data
- USB port and Bluetooth 4.0
- Two standard observer angles, a variety of illuminant, a variety of color indexes, conforms with a variety of standard colorimetric data
- Measure sample spectra, accurate Lab data, can be used in color matching and accurate color transmission

STANDARD DELIVERY

Main unit	1 pc
White and black calibration cavity	1 pc
Software and USB cable	1 pc
AC/DC adapter	1 pc

OPTIONAL ACCESSORY

Printer	9710-PRINTER
Powder test box	9710-POWDERBOX
Universal test kit	9710-TESTKIT

To be continued

Continued from previous page

SPECIFICATION

Optical geometry	reflect: di: 8°, de: 8° (diffused illumination, 8-degree viewing angle)	
Integrating sphere size	Ø48mm	
Light source	combined LED light, UV light	
Spectrophotometric mode	concave grating	
Sensor	256 image element double array CMOS image sensor	
Wavelength range	400~700nm	
Wavelength interval	10nm	
Semiband width	10nm	
Measured reflectance range	0~200%	
Measuring aperture	dual aperture: MAV: Ø8mm; SAV: Ø4mm	
Specular component	SCI&SCE	
Color space	CIE LAB, XYZ, Yxy, LCh, CIE LUV, hunter LAB	
Color difference formula	ΔE^*ab , ΔE^*uv , ΔE^*94 , ΔE^*cmc (2:1), ΔE^*cmc (1:1), ΔE^*00v , ΔE (Hunter)	
Other colorimetric index	WI (ASTM E313, CIE/ISO, AATCC, hunter), YI (ASTM D1925, ASTM 313), metamerism index MI, staining fastness, color fastness, colorstrength, opacity	
Observer angle	2°/10°	
Illumination	A, C, D50, D55, D65, D75, F1, F2, F3, F4, F5, F6, F7, F8, F9, F10, F11, F12, CWF, U30, T183, T184, U35	
Displayed data	spectrogram/values, samples chromaticity values, color difference values/graph, PASS/FAIL result, color offset	
Measuring time	2.6s	
Repeatability	spectral reflectance	MAV/SCI, within 0.08% of standard deviation (400~700nm: 0.18%)
	colorimetric values	MAV/SCI: $\Delta E^* \leq 0.03$
Inter-instrument error	MAV/SCI: $\Delta E^* \leq 0.15$	
Measurement mode	single measurement, average measurement	
Data port	USB, bluetooth 4.0	
Data storage	standard 1000 pcs, sample 28000 pcs	
Illuminant life span	5 years, more than 3 million times measurements	
Power supply	Li-ion battery, 5000 measurements within 8 hours	
Dimension	184×77×105mm	
Weight	600g	

33

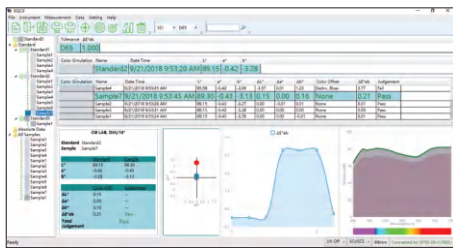

software

measurement data is sent to Excel

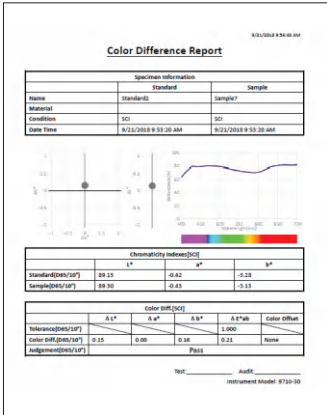

report

software (included), test can be controlled from the software, display test data, report



FOUR KINDS OF APERTURE

DATA OUTPUT



GRATING SPECTROPHOTOMETRIC

MATCHING COLOR CARD QUICKLY

HANDHELD SPECTROPHOTOMETERS (STANDARD TYPE)

- Conforms with CIE No.15, ISO7724-1, ASTM E1164 and DIN5033 Teil7 standards
- Grating spectrophotometric, 3.5" IPS full color screen, dual optical path high precise CMOS array sensor
- Use long life and low power consumption combined LED light source, include UV and exclude UV measurement
- Camera locating function, switchable four apertures
- Large capacity storage space, over 20000 measurement data
- Two standard observer angles, a variety of illuminant, a variety of color indexes, conforms with a variety of standard colorimetric data
- Measure sample spectra, accurate Lab data, can be used in color matching and accurate color transmission



5701-D40

33

white calibration cavity (included)



connect to computer

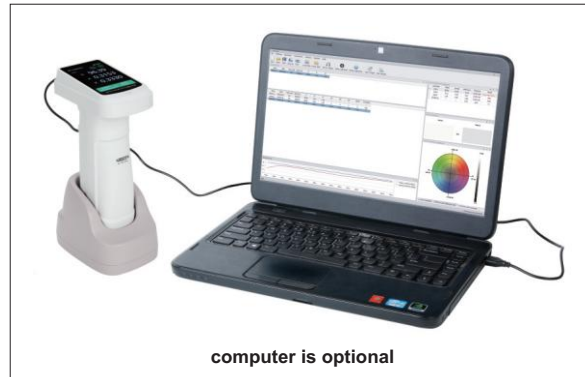

computer is optional

software (included), test can be controlled from the software, display test data, report

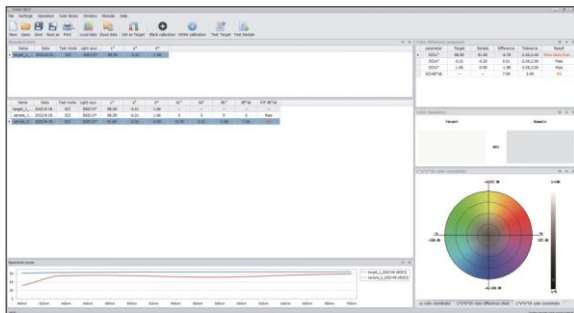

software

Report No: _____ Date: _____

Device name: _____ Test date: 2022-02-02

Item	Unit	Test result	SP	DP	DP	DP	DP	DP	DP	DP	DP	DP	DP	DP	DP	DP	DP	DP	DP	DP	
2022-02-02-01	SP	50.00	-0.25	1.00	0	0	0	0	0	0	0	0	0	0	0	0	0	0	0	0	0
2022-02-02-02	DP	50.00	-0.25	1.00	0	0	0	0	0	0	0	0	0	0	0	0	0	0	0	0	0
2022-02-02-03	DP	50.00	-0.25	1.00	0	0	0	0	0	0	0	0	0	0	0	0	0	0	0	0	0
2022-02-02-04	DP	50.00	-0.25	1.00	0	0	0	0	0	0	0	0	0	0	0	0	0	0	0	0	0

pure data report

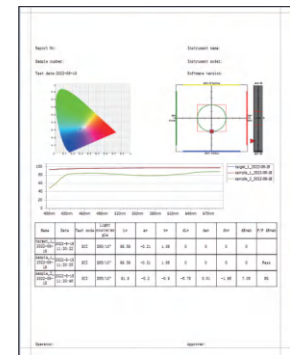

graphic report

To be continued

Continued from previous page

SPECIFICATION

Code	5701-D40	5701-D45
Optical geometry	D/8 (diffused illumination/8° direction reception), SCI+SCE (specular component included+specular component excluded)	45/0 (45° illumination/vertical reception)
Integrating sphere size	Ø40mm	ring lighting strips
Light source	LED (full band balanced LED)+UV	LED (full band balanced LED)
Spectrophotometric mode	grating	
Sensor	dual optical path high precise CMOS array sensor	
Wavelength range	400~700nm	
Wavelength interval	10nm	
Reflectance measurement range	0~200%	
Reflectance resolution	0.01%	
Display resolution	0.01	
Illumination area/aperture	MAV: Ø11mm; SAV: Ø6mm, Ø3mm; MINI: 1×3mm	
Color space	CIE-Lab, CIE-LCh, HunterLab, CIE Luv, XYZ, Yxy, RGB	
Color difference formula	ΔE^*ab , ΔE^*cmc , ΔE^*94 , ΔE^*00 , ΔE^*ch , ΔE^*uv , ΔEab	
Other colorimetric index	whiteness (ASTM E313-00, ASTM E313-73, CIE/ISO, AATCC, hunter, taube berger stensby), yellowness (ASTM D1925, ASTM 313-00, ASTM E313-73), blackness (My, dM), color fastness, tint (ASTM E313-73) color density CMYK (A, T, E, M), milm, munsell, opacity, color strength	
Observer angle	2°/10°	
Illumination	A, B, C, D50, D55, D65, D75, F1, F2, F3, F4, F5, F6, F7, F8, F9, F10, F11, F12, CWF, U30, U35, DLF, NBF, T183, T184, ID50, ID65, LED-B1, LED-B2, LED-B3, LED-B4, LED-B5, LED-BH1, LED-RGB1, LED-V1, LED-V2	
Measuring time	about 1.5s	
Repeatability	spectral reflectance	within 0.08% of standard deviation
	colorimetric values	$\Delta E^*ab \leq 0.025$ (after whiteboard correction, measuring the whiteboard 30 times at 5s interval)
Inter-instrument error	$\Delta E^*ab \leq 0.25$ (BCRA series II, average value of 12 color plates)	
Data port	USB, bluetooth	
Light source lifetime	10 years, more than 1 million times measurements	
Power supply	3.7V/3000mAh, rechargeable 8000 times continuous tests	
Dimension	95×129×231mm	
Weight	750g	

STANDARD DELIVERY

Main unit	1 pc
White calibration cavity	1 pc
Measuring aperture	9 pcs
USB cable	1 pc
USB disk	1 pc
AC/DC adapter	1 pc
Black light trap	1 pc



white calibration cavity
(included)



COLORIMETER (BASIC TYPE) CODE 5700-LS35



- Conforms with CIE 15, CIE S 005, ISO 7724-1 and ISO 13655 standards
- 3.5-inch IPS display and capacity touch panel
- Contains multiple color cards and can match the closest color code quickly
- QC testing function, can set color difference threshold
- Able to store 1000 colors and 1000 color comparison
- 3.7V/4000mAh battery, 10000 continuous measurements

SPECIFICATION

Illumination geometry	D/8, specular component include (SCI)
Illumination light source	full spectrum LED light source
Measurement conditions	light source D65, field of view 10°
Measuring time	about 1s
Color space	CIE Lab, Luv, LCh, Yxy, CMYK, RGB, Hex
Color difference formula	ΔE^*ab , ΔE^*uv , ΔE^*94 , $\Delta E^*cmc (2:1)$, $\Delta E^*cmc (1:1)$, ΔE^*00
Repeatability	standard deviation ΔE^*ab is within 0.03 (measurement condition: the average value of 30 measurements on the whiteboard at an interval of 3s after calibration)
Charging interface	USB (Type-C)
Dimension	86×63×158mm
Weight	245g

STANDARD DELIVERY

Main unit	1 pc
White calibration cavity	1 pc
USB cable	1 pc
AC/DC adapter	1 pc
Cleaning cloth	1 pc
Locating plate	1 pc



5704-CP01

- To calibrate color measuring instruments
- Made of ceramic
- Wear resistance, corrosion resistance, high optical stability
- Supplied with ISO17025 calibration certificate from National Institute of Metrology, China

COLOR STANDARD PLATES



calibration certificate (included)

SPECIFICATION

Code	5704-CP01	5704-CPB	5704-CPG	5704-CPW	5704-CPR	5704-CPY
Color	blue, green, white, red, yellow (full set)	blue	green	white	red	yellow
Spectral reflectance factor	spectral reflectance factor in the wavelength range of 380 nm to 780 nm					
Standard illuminant	D65, A, etc.					
Viewing angle	2°, 10°					
Color space	CIE-Lab, XYZ, etc.					
Annual variation	$\Delta x, \Delta y \leq 0.005$					
Dimension	50×50mm					

STANDARD DELIVERY

Calibration certificate	1 pc
--------------------------------	------

DIGITAL ADHESION TESTER CODE SPT-AD21

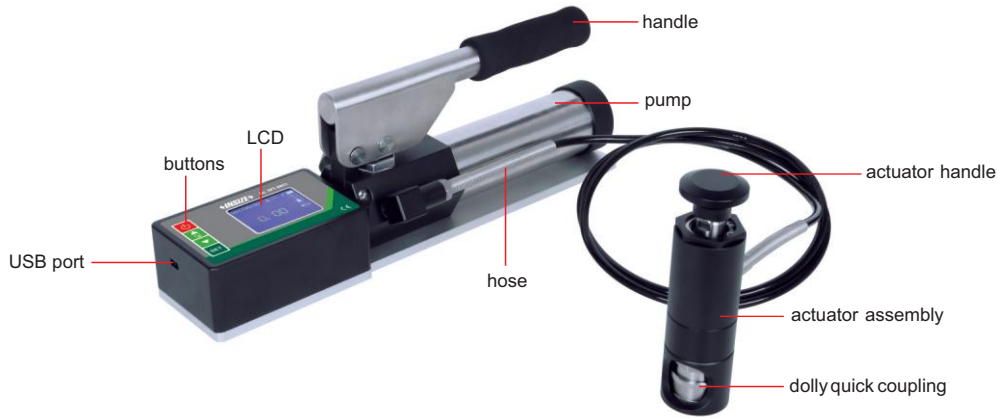

Ø20mm dolly (included)



glue gun and glue (included)



cutting tool (included) for Ø10mm, Ø14mm, Ø20mm dolly

- Pull-off test
- Built-in rechargeable lithium battery, no need external power source
- Portable design, can be used anywhere
- Standard USB interface, can directly transmit the stored data to computer, no need to install software
- Conforms to GB/T 5210, ASTM D4541/D7234, ISO 4624/16276-1
- Store all test results, includes maximum pull-off force, pull-off rate, dolly size and time
- Built in real-time clock, all saved data have corresponding date and time
- Selectable four different sizes dolly for different resolution and testing range
- No need conversion, the instrument can calculate pull-off force according to the dolly size
- Get the testing results from LCD directly
- Two units MPa and psi for selection and can be converted automatically

SPECIFICATION

Range	0~20MPa
Dolly diameter	Ø20mm
Resolution	0.01MPa (1psi)
Accuracy	±1% full scale
Pull-off force	0.7~20MPa
Power supply	built-in rechargeable lithium battery
Dimension (L×W×H)	360×75×115mm
Weight	3kg

STANDARD DELIVERY

Main unit	1 pc
Ø20mm dolly	20 pcs
Cutting tool	1 pc
Charger	1 pc
USB cable	1 pc
Glue gun	1 pc
3M glue	1 pc

OPTIONAL ACCESSORY

Ø10mm dolly	SPT-AD21-10	10 pcs/package pull-off force: 2.8~80MPa
Ø14mm dolly	SPT-AD21-14	10 pcs/package pull-off force: 1.4~40MPa
Ø20mm dolly	SPT-AD21-20	10 pcs/package pull-off force: 0.7~20MPa
Ø50mm dolly	SPT-AD21-50*	10 pcs/package pull-off force: 0.4~3.5MPa
Cutting tool	SPT-AD21-CUTTER1	for Ø10mm, Ø14mm, Ø20mm dolly
Cutting tool	SPT-AD21-CUTTER2*	for Ø50mm dolly
Sleeve	SPT-AD21-SLEEVE*	for Ø50mm dolly
Glue	SPT-AD21-GLUE	3M DP420 epoxy glue/50ml

*Ø50mm dolly requires corresponding cutter and sleeve



VIDEO

PENCIL HARDNESS TESTER CODE PHT-C751

- For flat coating surfaces
- Conform to ASTM D3363, ISO 15184, BS3900-E19 and ECCA-T4/1

SPECIFICATION

Pressure of pencil on coating	500g, 750g, 1000g (main unit is 500g, one weight is 750g, two weights are 1000g)
Angle between pencil and measured surface	45°
Dimension (L×W×H)	95×80×110mm
Weight	2kg

STANDARD DELIVERY

Main unit	1 pc
Weights	2 pcs
Leveling rod	1 pc
Level	1 pc
Pencil	12 pcs (4B, 3B, 2B, B, HB, F, H, 2H, 3H, 4H, 5H, 6H)
Pencil sharpener	1 pc

OPTIONAL ACCESSORY

Pencil (12 pcs: 4B-6H)	PHT-C751-P
400 grade abrasive paper	PHT-C751-S



VIDEO

- To test flat paint film
- Comply with ISO 7784-2, ISO 9352, GB/T1768, ASTM D3884, ASTM D1175 standards

ROTATIONAL ABRASION TESTER CODE QMY-AP32

SPECIFICATION

Platform rotary speed	60±2 r/min, 72±2 r/min (selectable)
Load weight	500g, 750g, 1000g
Sample size	Ø100mm
Grinding wheel	external diameter (51.6±0.1)mm, thickness (12.7±0.1)mm
Counting range of platform rotation	0~9999 times
Motor power	25W
Power supply	220V, 50Hz
Dimension	260×410×280mm
Weight	14kg



STANDARD DELIVERY

Main unit	1 pc
Vacuum cleaner	1 pc
1000g weight	2 pcs
750g weight	2 pcs
500g weight	2 pcs
TABER CS-10 grinding wheel	1 pair
Sandpaper	10 pcs
Glass plate	5 pcs

OPTIONAL ACCESSORY

TABER CS17 grinding wheel (1 pair)	QMY-AP32-CS17
Glass plate (Ø100mm with a 9mm center hole, 100 pcs/box)	QMY-AP32-GP
Aluminum plate (Ø100mm with a 9mm center hole, 100 pcs/box)	QMY-AP32-AP
180# emery cloth strip (100 pcs/box)	QMY-AP32-EC

CROSS CUT ADHESION TESTERS



VIDEO

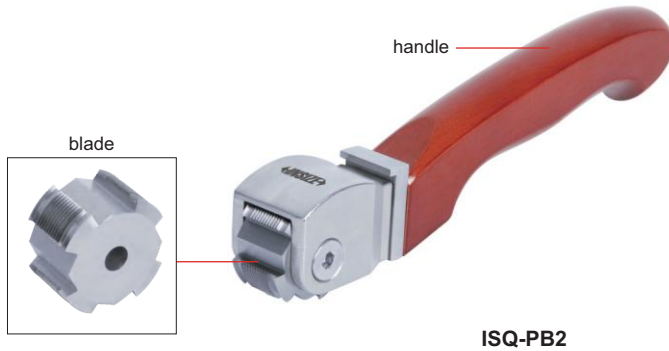

ISQ-PB2



test tape (included)



2X magnifier (included)



brush (included)



step 1: make grid cutting on surface



step 2: paste and remove the tape

0	The edges of the cuts are completely smooth, none of the squares of the lattice is detached.	
1	Detachment of small flakes of the coating at the intersections of the cuts. A cross-cut area greater than 5% is affected.	
2	The coating has flaked along the edges and/or at the intersections of the cuts. A cross-cut area greater than 5%, but not greater than 15%, is affected.	
3	The coating has flaked along the edges of the cuts partly or wholly in large ribbons, and/or it has flaked partly or wholly on different parts of the squares. A cross-cut area greater than 15%, but not greater than 35%, is affected.	

step 3: according to the shedding status, judge the adhesion grade

- To test the adhesion of paint coating on metal, wood, plastic, etc.
- According to ASTM D3359, BS 3900E6, BS/EN ISO 2409

SPECIFICATION

Code	ISQ-PB1	ISQ-PB2	ISQ-PB3	ISQ-PB4	ISQ-PB5
Type	octahedral blade				
Number of blade teeth	6	11	6	11	6
Blade pitch	1mm		2mm		3mm
Applied paint thickness	on hard substrate (like metal)		61~120µm		121~250µm
	on soft substrate (like wood, plaster)		0~120µm		121~250µm
Minimum substrate thickness	hard substrate (like metal)		0.25mm		
	soft substrate (like wood, plaster)		10mm		
Minimum size of test sample	150×100mm				
Dimension	handle		180×30×40mm		180×28×40mm
	blade		Ø30×18mm		Ø30×21mm
Weight	277g				

STANDARD DELIVERY

Handle	1 pc
Blade	1 pc
Test tape	1 pc
2X magnifier	1 pc
Brush	1 pc

OPTIONAL ACCESSORY

Code	Description	Applicable codes
ISQ-PBV	25mm wide test tape, consumable	all codes
ISQ-PB1-A	octahedral blade with 6 teeth and 1mm pitch	ISQ-PB1, ISQ-PB2 ISQ-PB3, ISQ-PB5
ISQ-PB2-A	octahedral blade with 11 teeth and 1mm pitch	
ISQ-PB3-A	octahedral blade with 6 teeth and 2mm pitch	ISQ-PB4
ISQ-PB4-A	octahedral blade with 11 teeth and 2mm pitch	
ISQ-PB5-A	octahedral blade with 6 teeth and 3mm pitch	ISQ-PB1, ISQ-PB2 ISQ-PB3, ISQ-PB5

CONICAL MANDREL TEST APPARATUS CODE PPS-A203



step 1: place specimen



step 2: compress specimen



step 3: start the experiment



step 4: record the results



- To test the cracking resistance and elongation of color paints and varnishes
- According to ASTM D 522, ISO 6860

SPECIFICATION

Conical arbor	small end diameter	3.1±0.1mm
	large end diameter	38±0.1mm
	length	203±3mm
Dimension	300×120×80mm	
Weight	8kg	

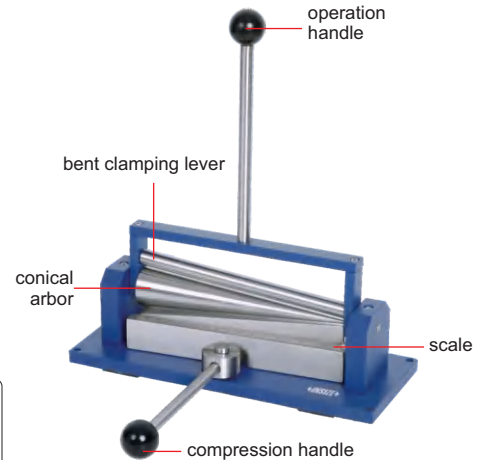

specimens (optional)



OPTIONAL ACCESSORY

Name	Code	Description
specimens	PPS-A203-1	material: burnished tinplate dimension: 150×75×0.28mm
	PPS-A203-2	material: burnished tinplate dimension: 150×100×0.28mm
	PPS-A203-3	material: cold-rolled steel dimension: 150×100×0.8mm



PAINT FILM FLEXIBILITY TESTER CODE PPF-BF62

- To test the flexibility of paint and varnish
- Bend the coated test plates on the shaft rods with different diameter, the minimum shaft rod diameter that does not cause damage to the film is the film flexibility



SPECIFICATION

Shaft rod length	35mm
Shaft rod 1	Ø15mm
Shaft rod 2	Ø10mm
Shaft rod 3	Ø5mm
Shaft rod 4	Ø4mm
Shaft rod 5	cross section 3×10mm, radius of curved surface 1.5mm
Shaft rod 6	cross section 2×10mm, radius of curved surface 1.0mm
Shaft rod 7	cross section 1×10mm, radius of curved surface 0.5mm
Dimension	450×75×100mm
Weight	3.1kg

STANDARD DELIVERY

Main unit	1 pc
Test plate	1 box (500 pcs)
4X magnifier	1 pc

OPTIONAL ACCESSORY

Test plate (dimension: 120×25×0.28mm, 500 pcs/box)	PPF-BF62-TP
--	-------------

**IMPACT TESTER
CODE THD-PF34**



300g main weight (included)



1000g main weight (included)



2lb main weight (included)



2lb additional weight (included)



1000g additional weight (included)



Ø16.3mm die base (included)



Ø12.7mm indenter (included)



Ø15.9mm indenter (included)



- For paint and varnish dry coating. To test the ability to resist cracking or peeling from the substrate when deformation is caused by weights impact under standard conditions
- Indenter, base and weight can be replaced quickly
- Conform to ISO 6272-2:2002, ASTM D 2794

SPCIFICATION

Impact height range	0-100cm (0-40inch)
Graduation	1cm
Impact depth	2.5cm
Weight	1000g (2pcs), 300g (1pc), 2lb (2pcs)
Indenter diameter	Ø12.7mm (1/2 inch DIA), Ø15.9mm (5/8 inch DIA)
Die base diameter	Ø16.3mm

OPTIONAL ACCESSORY

Base plate (120×70×0.5mm, 180pcs/box) *	THD-PF34-T
---	------------

*Can be customized according to the needs of different thickness, size and processing

STANDARD DELIVERY

Main unit	1 pc
1000g main weight	1 pc
300g main weight	1 pc
2lb main weight	1 pc
1000g additional weight	1 pc
2lb additional weight	1 pc
Ø12.7mm indenter	1 pc
Ø15.9mm indenter	1 pc
Ø16.3mm die base	1 pc



Electromagnetic Ultrasonic Thickness Gauges
Page 1072-1073



Ultrasonic Thickness Gauges
Page 1074-1081



Tachometers
Page 1083-1084



Stroboscopes
Page 1084



Vibration Meters
Page 1085-1087



Laser Distance Meters
Page 1088-1090



Stroke Counters
Page 1090



Digital Stopwatches
Page 1091



Digital Moisture Meters
Page 1092



Digital Pressure Calibrators
Page 1093-1094



Pressure Gauge Calibration Pumps
Page 1094-1095



Pressure Gauges
Page 1097-1098



Radiation Detectors
Page 1098



Eddy Current Conductivity Testers
Page 1099



Teslameters
Page 1100-1101



Light Transmittance Meters
Page 1102



Digital Glass Thickness Meters
Page 1103



Tripods
Page 1103

MEASUREMENT THROUGH COATING AND RUST LAYER

ELECTROMAGNETIC ULTRASONIC THICKNESS GAUGE CODE EMU-S340

NO COUPLING AGENT REQUIRED

NON-CONTACT MEASUREMENT

TEMPERATURE COMPENSATION



- No surface polishing required, can penetrate anti-corrosion coating and rust (maximum 4mm), no coupling agent required
- Normal temperature permanent magnetic probe and high temperature permanent magnetic probe are using weak permanent magnet, to replace the strong permanent magnet commonly used nowadays. Completely solve the problem that EMAT transducer suction force is too large and difficult to move, so that the manual inspection is more simple, convenient and safe
- Temperature compensation function, can input the actual temperature of high-temperature components to automatically compensate the speed of sound, making the thickness measurement value more accurate
- Measurement of non verticality up to $\pm 25^\circ$, low verticality requirements for probe placement
- Scanning mode: A-scan format, B-scan image format display of thickness measurement values
- 50000 thickness values and 4000 A-scan or B-scan data can be stored
- Integrated high-brightness LEDs on the back for easy on-site illumination



34

SPECIFICATION

Measuring range	1.5~200mm (steel, stainless steel)
Resolution	0.02mm
Accuracy	$\pm 0.04\text{mm} + H/1000$ ($H \leq 50\text{mm}$) $\pm 0.2\text{mm}$ ($50 \geq H \geq 100\text{mm}$) $\pm 0.3\text{mm}$ ($100 \geq H \geq 200\text{mm}$)
Working gap (the distance between the probe and the measured object)	normal temperature permanent magnetic probe $\leq 4\text{mm}$ high temperature permanent magnetic probe $\leq 2\text{mm}$
Minimum required diameter	$\geq 8\text{mm}$
Non-perpendicularity	$\pm 25^\circ$
Excitation frequency	3.0MHz~3.9MHz
Material velocity	1000~9999m/s
Adjustment increments	1m/s
Gate function	automatic gate, manual single gate, manual double gate
Display	color LCD, 3.5 inch/320×480 pixel
Interface	USB2.0
Power supply	rechargeable lithium battery, working time ≥ 8 hours
Dimension	195×90×40mm
Weight	820g



normal temperature permanent magnetic probe sweep support
EMU-S52 (optional)



high temperature permanent magnetic probe
EMU-S51 (optional)

STANDARD DELIVERY

Main unit	1 pc
Transducer EMU-S50	1 pc
Calibration block (diameter $\varnothing 36 \times$ wall thickness 10mm)	1 pc
4G USB flash disk	1 pc
USB cable	1 pc

OPTIONAL ACCESSORY

High temperature permanent magnetic probe	EMU-S51
Normal temperature permanent magnetic probe sweep support	EMU-S52

SPECIFICATION OF TRANSDUCERS

Code	Magnetism	Magnetic force	Diameter ($\varnothing d$)	Applicable temperature	Application
EMU-S50 (included)	weak permanent magnet	$\leq 15\text{N}$	$\varnothing 30\text{mm}$	$-10 \sim 60^\circ\text{C}$	general use
EMU-S51 (optional)	weak permanent magnet	$\leq 20\text{N}$	$\varnothing 45\text{mm}$	$-50 \sim 800^\circ\text{C}$	for high temperature

PEN TYPE ELECTROMAGNETIC ULTRASONIC THICKNESS GAUGES



COUPLING AGENT IS NOT REQUIRED

MEASUREMENT THROUGH COATING AND RUST LAYER

WORK AT MAXIMUM 600°C

WITH A AND B SCAN



high temperature probe (optional)



calibration block (included)



normal temperature probe (included)

EMU-A100



A-Scan

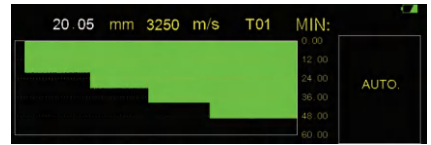

B-Scan

- Measurement without ultrasonic coupling agent, for workpieces with surface temperatures less than 600°C (depending on the probes)
- Compact size, easy to carry, comes with waveform display and full-function keyboard, easy to adjust the measurement parameters
- Non-contact measurement of rough, corroded surfaces without sanding
- Storage of 10000 data and 100 files
- Highly intelligent functions such as alarm for exceeding upper and lower limits, automatic zero calibration, automatic identification of probes, etc.
- Automatic power off
- Suitable for inspection of workpieces of various shapes, such as pipes, small tubes, elbows, etc.

SPECIFICATION

Code	EMU-A100	EMU-B100
Data output	USB	USB, Bluetooth
Measuring range	refer to the specification of probes	
Resolution	0.01mm	
Accuracy	$\pm 0.04\text{mm}$ ($H \leq 10\text{mm}$) $\pm (0.04 + H/1000)\text{mm}$ ($10 \leq H < 100\text{mm}$) $\pm H/333\text{mm}$ ($H \geq 100\text{mm}$) H is measuring thickness in mm	
Working gap (the distance between the probe and the measured object)	$\leq 1\text{mm}$	
Gain	automatic and manual gain	
Material velocity	1000~9999 m/s	
Measurement frequency	2 times/second 10 times/second fast measurement mode	
Measuring mode	auto mode, manual mode	
Display	LED, 800×268	
Storage	10000 data stored in 100 files	
Power supply	5V rechargeable lithium battery, 6 hours working time	
Operation temperature	-10°C~350°C	
Dimension	180×35×34mm	
Weight	300g	

STANDARD DELIVERY

Main unit	1 pc
Normal temperature probe	1 pc
Calibration block (8mm)	1 pc
USB cable	1 pc

OPTIONAL ACCESSORY

High temperature probe	EMU-B100-T02
------------------------	--------------

SPECIFICATION OF PROBES

Code	Magnet	Measuring range	Diameter (Ød)	Working temperature	Applications
EMU-B100-T01 (included)	permanent magnet	1.5~150mm	Ø20mm	-10~120°C	general use, mainly used for fine crystal materials, such as mild steel, aluminum
EMU-B100-T02 (optional)	permanent magnet	1.5~300mm	Ø25mm	-10~600°C	high temperature environment, mainly used for ferromagnetic fine crystal materials, such as mild steel

PENETRATE COATING AND MEASURE THE THICKNESS OF SUBSTRATE

BLUETOOTH

ULTRASONIC THICKNESS GAUGE (ADVANCED TYPE) CODE ISU-800D



REAL-TIME TEMPERATURE COMPENSATION

DATA OUTPUT

- Real-time temperature compensation eliminates the error caused by temperature variation
- Support both single element transducers and dual element transducers
- Measure the thickness of substrate through coating
- Measuring mode: standard mode (dual element transducer P-E mode, single element transducer: I-E mode), penetrate coating mode (dual element transducer: I-E mode, single element transducer: E-E mode or auto mode)
- Measure method: single point, scanning, deviation
- Set upper and lower limits for alarm when out-of-tolerance
- Single point and 2 points calibration
- Keyboard lock function avoids parameter setting change caused by unintended press during measurement
- Memory 1000 measurement values
- Data can be transmitted to PC by Bluetooth connection or Mini-USB cable



transducer
ISU-S15-P06
(included)



transducer
ISU-S2M-P14
(optional)



transducer
ISU-G5M-P10
(optional)



transducer
ISU-G5M-P08
(optional)



transducer
ISU-G7M-P06
(optional)



transducer
ISU-G2M-P12
(optional)



transducer
ISU-H3M-P12
(optional)



delay block
ISU-S15-P06-CB
(optional)



delay block
ISU-S15-P06-CB1
(optional)



SPECIFICATION

Measuring range	refer to the specification of transducers
Resolution	0.01mm/0.001mm
Accuracy	refer to the specification of transducers
Data output	bluetooth and USB
Velocity	1~19999m/s
Power supply	3.7V rechargeable lithium battery
Dimension	157×78×37mm
Weight	260g

STANDARD DELIVERY

Main unit	1 pc
Transducer ISU-S15-P06	1 pc
Power adaptor	1 pc
USB cable	1 pc
Couplant	1 bottle

OPTIONAL ACCESSORY

Transducer	refer to the specification of transducers
Couplant (for ISU-H3M-P12)	ISU-HT5-COUPPLANT
Thermal printer (with cable)	ISU-800D-PRINTER

SPECIFICATION OF TRANSDUCERS (ON STEEL)

Code	Type	Freq	Diameter (Ød)	Measuring range	Min. size of pipes (diameter x wall thickness)	Accuracy	Applicable temperature	Application
ISU-S15-P06 (included)	single element	15MHz	8mm	I-E: 0.9~28mm E-E: 0.15~14mm	Ø10x1.5mm Ø15x0.35mm	±0.02mm/0.3% ^{H*} (take the larger one)	-10~60°C	high precision or thin workpieces
ISU-S15-P06-CB (optional)**	-	-	5mm	I-E: 0.9~10mm E-E: 0.15~5mm	Ø10x1.2mm Ø15x0.35mm			high precision or irregular surface
ISU-S15-P06-CB1 (optional)**	-	-	8mm	I-E: 0.9~38mm E-E: 0.3~19mm	-			high precision or thick workpieces
ISU-S2M-P14 (optional)	single element	2MHz	19mm	I-E: 30~2000mm E-E: 30~1000mm	-	±0.5% ^{H*}	-10~310°C	ultra-thick workpieces
ISU-G5M-P10 (optional)	dual element	5MHz	13mm	0.8~300mm	Ø25x3mm	±0.04mm (range: <10mm) ±H/333mm* (range: ≥10mm)	-10~60°C	normal workpieces
ISU-G5M-P08 (optional)	dual element	5MHz	11mm	0.8~225mm	Ø20x1.2mm			curved surface and normal workpieces
ISU-G7M-P06 (optional)	dual element	7.5MHz	9mm	0.8~50mm	Ø15x1.2mm			curved surface and small workpieces
ISU-G2M-P12 (optional)	dual element	2MHz	17mm	3~700mm	Ø30x4mm			castings and thick workpieces
ISU-H3M-P12 (optional)	dual element	3MHz	15mm	2~200mm	Ø25x3mm	±0.05mm/0.5% ^{H*} (take the larger one)	-10~310°C	workpieces with high temperature

* H is the measured thickness in mm

** Delay blockers, suitable for transducer **ISU-S15-P06**

ULTRASONIC THICKNESS GAUGE CODE ISU-810D

PENETRATE COATING AND MEASURE
THE THICKNESS OF SUBSTRATES

WITH A AND B SCAN

DATA
OUTPUT



- Measure the thickness of substrate through coating
- Measuring mode: standard mode (dual element transducer: P-E), penetrate coating mode (dual element transducer: E-E)
- Display mode: real-time color A-scan waveform mode, real-time color B-scan waveform mode, thickness value mode, Min/Max capture mode, difference or reduction rate mode
- Can measure gray cast iron, ductile iron, PE, PVC pipe, fiberglass, 3PE anticorrosive layer pipes, metal pipes, pressure vessels, shaped parts, wall thickness of small pipes etc.
- Set the upper and lower limits, and the reading color will change when the limit is exceeded
- One-point calibration and two-point calibration
- Can compensate the non-linearity of the twin-crystal probe by automatic V path correction
- Can store 100000 thickness values and 1000 waveforms
- USB 2.0 port connected to computer for statistics
- Languages: Chinese, English, German, French, Japanese
- Power off: automatic/manual



SPECIFICATION

Measuring range	refer to the specification of transducers
Resolution	0.1/0.01mm
Accuracy	±0.05mm (H<10mm) ±(0.05%H+0.01)mm (H≥100mm) H is the thickness to be measured in mm
Display	320×240, color screen display
Measuring frequency	4Hz, 8Hz, 16Hz
Velocity	500~9999m/s
Applicable temperature	-20~50°C
Output	USB
Measuring unit	mm/inch
Power supply	2×1.5V AA batteries
Dimension	153×76×37mm
Weight	280g (including batteries)

STANDARD DELIVERY

Main unit	1 pc
Transducer ISU-810D-TC510	1 pc
Battery (AA)	2 pcs
Couplant	1 bottle
USB cable	1 pc

SPECIFICATION OF TRANSDUCERS

Code	Frequency	Diameter (Ød)	Measuring range	Applicable temperature	Application
ISU-810D-TC510 (included)	5MHz	13.5mm	1.2~400mm	-10~70°C	normal workpieces
ISU-810D-TC550 (optional)	5MHz	13.5mm	1~200mm	-10~70°C	fiberglass and organic material
ISU-810D-PT04 (optional)	10MHz	7mm	0.7~12mm	-10~70°C	small diameter workpieces
ISU-810D-PT06 (optional)	7.5MHz	8.7mm	0.8~30mm	-10~70°C	curved surface and small workpieces
ISU-810D-PT08 (optional)	5MHz	11mm	0.8~100mm	-10~60°C	normal workpieces
ISU-810D-ZT12 (optional)	2MHz	17mm	4~508mm	-10~70°C	cast iron (coarse grain) and thick workpieces
ISU-810D-GT12 (optional)	3MHz	15mm	2~80mm	-20~480°C	workpieces with high temperature

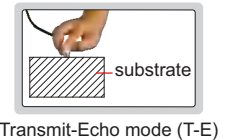
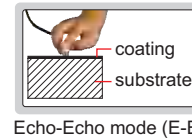

OPTIONAL ACCESSORY

Transducer	refer to the specification of transducers
Couplant (for ISU-810D-GT12)	ISU-HT5-COULPLANT

PENETRATE NON-METALLIC COATING AND MEASURE THE THICKNESS OF METAL SUBSTRATES



DATA OUTPUT

WITH A AND B SCAN

ULTRASONIC THICKNESS GAUGE CODE ISU-720D

- Two measuring modes, Echo-Echo (E-E) and Transmit-Echo (T-E):
 - E-E is applicable for non-metallic coating (such as paint, plastic resin, etc.) on metal substrates, can penetrate coating and measure the thickness of substrates
 - T-E is to measure the thickness of material without coating, such as metal, plastic, glass, nylon, resin, ceramics, ice, etc.
- A scan, through the waveform, judges whether there are impurities, pores, cracks and so on inside, in order to avoid wrong measurement
- B scan, measures continuously, displays the thickness change on the screen
- Transducers can be automatically identified and zeroed
- Memory 10000 measurement values
- Data can be input to Excel and Word as keyboard signal
- Automatic or manual measurement
- When transducers are removed from workpieces, the measurement data are held on screen for easy viewing
- Set upper and lower limits for alarm when out-of-tolerance
- Automatic power off



SPECIFICATION (ON STEEL)

Measuring range	refer to specification of transducers
Resolution	0.1/0.01mm
Accuracy	±0.04mm (H<10mm) ±(0.04+H/1000)mm (10≤H<100mm) ±H/333mm (H≥100mm) H is the thickness to be measured in mm
Frequency	refer to specification of transducers
Display	320×240, color screen display
Velocity	1000~9999m/s
Measuring frequency	2 times/second and 10 times/second
Operation temperature of main unit	-20~50°C
Output	USB
Measuring unit	mm/inch
Power supply	2×1.5V AA batteries
Dimension	133×75×29mm
Weight	260g (including batteries)

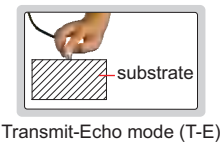
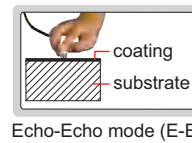

transducer **ISU-T04** (optional)



transducer **ISU-T06** (optional)



transducer **ISU-T08** (optional)



transducer **ISU-T12** (optional)



transducer **ISU-T13** (optional)



transducer **ISU-T25** (optional)



STANDARD DELIVERY

Main unit	1 pc
Bicrystal transducer ISU-T07	1 pc
Battery (AA)	2 pcs
Couplant	1 bottle
USB cable	1 pc

OPTIONAL ACCESSORY

Transducer	ISU-T04, ISU-T06, ISU-T08, ISU-T12, ISU-T13, ISU-T25
Couplant (for ISU-T13)	ISU-HT5-COULPLANT

SPECIFICATION OF TRANSDUCERS (ON STEEL)

Code	Mode	Frequency	Diameter (Ød)	Measuring range	Minimum size of pipes for measurement (diameter × wall thickness)	Applicable temperature	Application
ISU-T07 (included)	T-E E-E	5.0MHz	13.2mm	T-E mode: 1.5~200mm E-E mode: 3~25mm	T-E mode: Ø25×3mm	-20~60°C	general use
ISU-T04 (optional)	T-E	10.0MHz	6mm	0.7~20mm	Ø15×1mm	-20~60°C	for small tubes
ISU-T06 (optional)	T-E	7.5MHz	9mm	0.7~50mm	Ø15×1.2mm	-20~60°C	for thin workpieces
ISU-T08 (optional)	T-E	5.0MHz	11mm	0.8~300mm	Ø25×1.2mm	-20~60°C	general use
ISU-T12 (optional)	T-E	2.0MHz	17mm	2~400mm	Ø40×3mm	-20~60°C	for casting iron
ISU-T13 (optional)	T-E	5.0MHz	15mm	3~100mm	Ø25×2mm	0~350°C	for high temperature
ISU-T25 (optional)	T-E	1.0MHz	26mm	3~200mm	-	-20~60°C	for fiberglass and organic material

ULTRASONIC THICKNESS GAUGE (FOR THICK WORKPIECES MADE OF ORGANIC MATERIALS) CODE ISU-710D

DATA
OUTPUT

WITH A AND B SCAN



34

- For thick workpieces made of organic materials
- A scan, through the waveform, judges whether there are impurities, pores, cracks and so on inside, in order to avoid wrong measurement
- B scan, measures continuously, displays the thickness change on the screen
- Transducers can be automatically identified and zeroed
- Memory 10000 measurement values
- Data can be input to Excel and Word as keyboard signal
- Automatic or manual measurement
- When transducers are removed from workpieces, the measurement data are held on screen for easy viewing
- Set upper and lower limits for alarm when out-of-tolerance
- Automatic power off

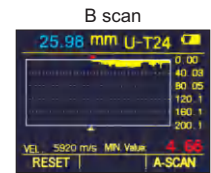
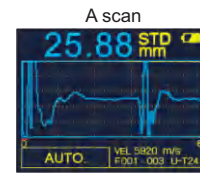

SPECIFICATION (ON STEEL)

Measuring range		20~590mm
Resolution		0.1/0.01mm
Accuracy		±(0.04+H/1000)mm (H<100mm) ±H/333mm (H≥100mm) H is the thickness to be measured in mm
Transducer	type	single element transducer
	frequency	1.0MHz
	diameter (Ød)	26mm
Display		320×240, color screen display
Velocity		1000~9999m/s
Measuring frequency		2 times/second and 10 times/second
Operation temperature		main unit: -20~50°C transducer: -20~60°C
Output		USB
Measuring unit		mm/inch
Power supply		2×1.5V AA batteries
Dimension		133×75×29mm
Weight		260g (including batteries)

STANDARD DELIVERY

Main unit	1 pc
Transducer	1 pc
Battery (AA)	2 pcs
Couplant	1 bottle
USB cable	1 pc

DATA
OUTPUT

WITH A AND B SCAN

ULTRASONIC THICKNESS GAUGE (FOR THIN WORKPIECES) CODE ISU-700D



- For thin workpieces
- A scan, through the waveform, judges whether there are impurities, pores, cracks and so on inside, in order to avoid wrong measurement
- B scan, measures continuously, displays the thickness change on the screen
- Transducers can be automatically identified and zeroed
- Memory 10000 measurement values
- Data can be input to Excel and Word as keyboard signal
- Automatic or manual measurement
- When transducers are removed from workpieces, the measurement data are held on screen for easy viewing
- Set upper and lower limits for alarm when out-of-tolerance
- Automatic power off

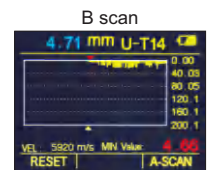

SPECIFICATION (ON STEEL)

Measuring range	Transmit-echo (T-E) mode:	1.5~20mm
	Echo-echo (E-E) mode:	0.2~10mm
Resolution		0.1/0.01/0.001mm
Accuracy		±0.04mm (H<10mm) ±(0.04+H/1000)mm (H≥10mm) H is the thickness to be measured in mm
Transducer	type	single element transducer
	frequency	15.0MHz
	diameter (Ød)	7.5mm
Display		320×240, color screen display
Velocity		1000~9999m/s
Measuring frequency		2 times/second and 10 times/second
Operation temperature		main unit: -20~50°C transducer: -20~60°C
Output		USB
Measuring unit		mm/inch
Power supply		2×1.5V AA batteries
Dimension		133×75×29mm
Weight		260g (including batteries)

transducer protective sleeve (included)

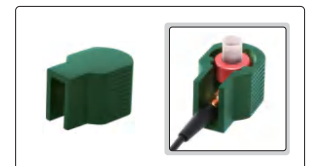

STANDARD DELIVERY

Main unit	1 pc
Transducer	1 pc
Transducer protective sleeve	1 pc
Battery (AA)	2 pcs
Couplant	1 bottle
USB cable	1 pc

ULTRASONIC THICKNESS GAUGE (THROUGH COATING) CODE ISU-300D

PENETRATE NON-METALLIC COATING AND
MEASURE THE THICKNESS OF METAL SUBSTRATE



DATA
OUTPUT

INSPECTION
CERTIFICATE

- Two measuring modes, Echo-Echo (E-E) and Transmit-Echo (T-E):
 - E-E is applicable for non-metallic coating (such as paint, plastic resin, etc.) on metal substrates, can penetrate coating and measure the thickness of substrates
 - T-E is to measure the thickness of material without coating, such as metal, plastic, glass, nylon, resin, ceramics, ice, etc.
- Tolerance measurement
- Average calculation of maximum 9 readings
- Data can be input to Excel and Word as keyboard signal



34

SPECIFICATION (ON STEEL)

Measuring range	refer to specification of transducers
Resolution	0.1/0.01mm
Accuracy	±0.04mm (H<10mm) ±(0.04+H/1000)mm (10≤H<100mm) ±H/333mm (H≥100mm) H is the thickness to be measured in mm
Velocity	1000~9999m/s
Operation temperature of main unit	-20~50°C
Output	USB
Measuring unit	mm/inch
Power supply	2×1.5V AAA batteries
Dimension	116×64×27mm
Weight	220g

STANDARD DELIVERY

Main unit	1 pc
Transducer ISU-T07	1 pc
Battery (AAA)	2 pcs
Couplant (for ISU-T04, ISU-T06, ISU-T07, ISU-T12)	1 bottle
USB cable	1 pc



OPTIONAL ACCESSORY

Transducer	ISU-T04, ISU-T06, ISU-T12, ISU-T13
Couplant (for ISU-T13)	ISU-HT5-COUPPLANT

SPECIFICATION OF TRANSDUCERS (ON STEEL)

Code	Mode	Frequency	Diameter (Ød)	Measuring range	Minimum size of pipes for measurement (diameter × wall thickness)	Applicable temperature	Application
ISU-T07 (included)	T-E E-E	5.0MHz	13.2mm	T-E mode: 1.5~200mm E-E mode: 3~25mm	T-E mode: Ø25×3mm	-20~60°C	general use
ISU-T04 (optional)	T-E	10.0MHz	6mm	0.7~20mm	Ø15×1mm	-20~60°C	for small tubes
ISU-T06 (optional)	T-E	7.5MHz	9mm	0.7~50mm	Ø15×1.2mm	-20~60°C	for thin workpieces
ISU-T12 (optional)	T-E	2.0MHz	17mm	2~400mm	Ø40×3mm	-20~60°C	for casting iron
ISU-T13 (optional)	T-E	5.0MHz	15mm	3~100mm	Ø25×2mm	0~350°C	for high temperature



- Measure the thickness from one side of objects, suitable for pipes, tanks, etc.
- Applicable material: metal, plastic, glass, nylon, resin, ceramic, ice
- Tolerance measurement
- Average calculation of 9 readings
- Data can be input to Excel and Word as keyboard signal



SPECIFICATION (ON STEEL)

Measuring range	refer to specification of transducers
Resolution	0.1/0.01mm
Accuracy	±0.04mm (H<10mm) ±(0.04+H/1000)mm (10≤H<100mm) ±H/333mm (H≥100mm) H is the thickness to be measured in mm
Velocity	1000-9999m/s
Operation temperature of main unit	-20~50°C
Output	USB
Measuring unit	mm/inch
Power supply	2×1.5V AAA batteries
Dimension	64×116×27mm
Weight	220g



transducer ISU-T06 (optional)



transducer ISU-T13 (optional)



transducer ISU-T04 (optional)



transducer ISU-T12 (optional)

STANDARD DELIVERY

Main unit	1 pc
Transducer ISU-T08	1 pc
Battery (AAA)	2 pcs
Couplant (for ISU-T04, ISU-T06, ISU-T08, ISU-T12)	1 bottle
USB cable	1 pc

OPTIONAL ACCESSORY

Transducer	ISU-T04, ISU-T06, ISU-T12, ISU-T13
Couplant (for ISU-T13)	ISU-HT5-COULPLANT

SPECIFICATION OF TRANSDUCERS (ON STEEL)

Code	Frequency	Diameter (Ød)	Measuring range	Minimum size of pipes for measurement (diameter × wall thickness)	Applicable temperature	Application
ISU-T08 (included)	5.0MHz	11mm	0.8~300mm	Ø25×1.2mm	-20~60°C	general use
ISU-T04 (optional)	10.0MHz	6mm	0.7~20mm	Ø15×1mm	-20~60°C	for small tubes
ISU-T06 (optional)	7.5MHz	9mm	0.7~50mm	Ø15×1.2mm	-20~60°C	for thin workpieces
ISU-T12 (optional)	2.0MHz	17mm	2~400mm	Ø40×3mm	-20~60°C	for casting iron
ISU-T13 (optional)	5.0MHz	15mm	3~100mm	Ø25×2mm	0~350°C	for high temperature

ULTRASONIC THICKNESS GAUGE (BASIC TYPE) CODE ISU-100D



ATTENTION: NOT SUITABLE FOR
CASTINGS AND ALUMINUM WORKPIECES

INSPECTION
CERTIFICATE

POPULAR
MODEL



- Measure the thickness from one side of objects, suitable for pipes, tanks, etc.
- Applicable material: steel, stainless steel, glass, copper, brass, polystyrene, titanium, etc.

SPECIFICATION (ON STEEL)

Measuring range		0.8~300mm
Resolution		0.1/0.01mm
Accuracy		±0.05mm (H<10mm) ±(0.05+H/1000)mm (10≤H<100mm) ±H/333mm (H≥100mm) H is the thickness to be measured in mm
Transducer	frequency	5MHz
	diameter (Ød)	10.8mm
Minimum size of pipes		20×1.2mm (diameter×wall thickness)
Velocity		1000-9999m/s
Operation temperature		main unit: -20~50°C transducer: -20~60°C
Measuring unit		mm/inch
Power supply		2×AAA batteries
Dimension		114×64×28mm
Weight		200g



STANDARD DELIVERY

Main unit	1 pc
Transducer	1 pc
Couplant	1 bottle
Battery (AAA)	2 pcs

STEP WEDGE BLOCKS
CAN BE CUSTOMIZED

STANDARD TEST BLOCKS FOR ULTRASONIC THICKNESS GAUGES

INSPECTION
CERTIFICATE



cylinder block

- Supplied with manufacturer inspection certificate
- Material of step wedge blocks can be customized

Cylinder block set (17 blocks are included) (mm)

Code	Material	Diameter	Thickness	Accuracy	QTY
ISU-ST	45#	20	0.5	±0.01	1 pc
	45#	20	1		1 pc
	45#	20	1.2		1 pc
	45#	20	1.5		1 pc
	45#	20	2		1 pc
	45#	20	3.3		1 pc
	45#	20	5.5		1 pc
	45#	20	7.7	±0.02	1 pc
	45#	20	10		1 pc
	45#	20	15		1 pc
	45#	20	20		1 pc
	45#	20	25		1 pc
	45#	20	50		1 pc
	45#	20	75		1 pc
	45#	20	100	±0.05	1 pc
	45#	20	150		1 pc
	45#	20	200		1 pc



round tube block

Round tube block set (2 blocks are included) (mm)

Code	Material	Outer diameter	Wall thickness	Accuracy	Length	QTY
ISU-SWT	45#	30	2	±0.02	40	1 pc
	45#	40	3	±0.02	40	1 pc



step wedge block

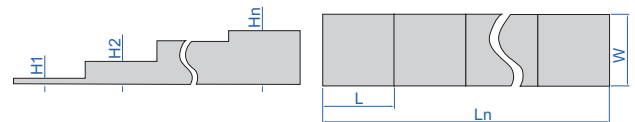

Step wedge blocks

(mm)

Code	Material	QTY of steps (n)	Thickness							Accuracy	Width (W)	Length of each step (L)	Total length (Ln)
			H1	H2	H3	H4	H5	H6	H7				
ISU-S4A	45#	4	6.25	12.5	18.75	25	-	-	-	±0.02	20	20	80
ISU-S4B	45#	4	5	10	15	20	-	-	-	±0.02	20	20	80
ISU-S5A	45#	5	2.5	5	7.5	10	12.5	-	-	±0.02	20	20	100
ISU-S5B	45#	5	2	4	6	8	10	-	-	±0.02	20	20	100
ISU-S7A	45#	7	3	12.5	24	30	36	42	48	±0.02	40	40	280
ISU-S7B	45#	7	1	1.5	2	4	6	8	10	±0.02	40	40	280

CONTACT/NON-CONTACT TACHOMETER CODE 9225-405



- 2 measuring methods, contact and non-contact
- Can measure rotary speed and line speed
- Automatically save the maximum value, minimum value and the last value, 500 data can be stored during continuous measurement
- Automatic power off



cone head
(included)



cone cavity
head (included)



reflection sticker
(included)



wheel with 0.1m
perimeter (included)



small cone head
(included)



clamping sleeve
(included)



34

SPECIFICATION

Measuring method		Non-contact	Contact
Measuring range	rotary speed	2.5~99999RPM	0.5~19999RPM
	line speed	—	0.05~500m/min
Resolution	rotary speed	0.1RPM (range 2.5~999.9RPM) 1RPM (range 1000~99999RPM)	0.1RPM (range 0.5~999.9RPM) 1RPM (range 1000~19999RPM)
	line speed	—	0.01m/min (range 0.05~99.99m/min) 0.1m/min (range 100~500m/min)
Accuracy	rotary speed	$\pm(0.05\%n+1d)$ RPM n is rotary speed, d is resolution	$\pm(0.4\%n+1d)$ RPM (n<300RPM) $\pm(0.05\%n+1d)$ RPM (n≥300RPM) n is rotary speed, d is resolution
	line speed	—	$\pm(1\%+1d)$ m/min d is resolution
Laser power		class 3R, 3mW~4mW	—
Sampling time		0.6s (above 100RPM)	
Measuring distance		50~500mm	—
Operation temperature		0~40°C	
Power supply		3×AA batteries	
Dimension		206×71×36mm	
Weight		170g	

STANDARD DELIVERY

Main unit	1 pc
Reflection sticker (9220-RS)	3 pcs
Wheel with 0.1m perimeter	1 pc
Clamping sleeve	1 pc
Cone head	1 pc
Small cone head	1 pc
Cone cavity head	1 pc
Battery (AA)	3 pcs

NON-CONTACT TACHOMETER CODE 9223-120



- Accurately measure the rotary speed without contact
- Automatically save the maximum value, minimum value and the last value, 500 data can be stored during continuous measurement

SPECIFICATION

Measuring range	2.5~99999RPM
Resolution	0.1RPM (range 2.5~999.9RPM) 1RPM (range 1000~99999RPM)
Accuracy	$\pm(0.05\%n+1d)$ RPM n is rotary speed, d is resolution
Laser power	class 3R, 3mW~4mW
Sampling time	0.6 second (above 100RPM)
Measuring distance	50~500mm
Operation temperature	0~40°C
Power supply	3×AA batteries
Dimension	180×71×29.9mm
Weight	145g



reflection sticker
(included)

STANDARD DELIVERY

Main unit	1 pc
Reflection sticker (9220-RS)	3 pcs
Battery (AA)	3 pcs



- Can measure rotary speed, line speed and line length
- Automatically save the maximum value, minimum value and the last value, 96 data can be stored during continuous measurement
- With backlight display

SPECIFICATION

Measuring range	rotary speed	0.5~19999RPM
	line speed	0.05~500m/min
	line length	0.05~99999m
Resolution	rotary speed	0.1RPM (range 0.5~999.9RPM) 1RPM (range 1000~19999RPM)
	line speed	0.01m/min (range 0.05~99.99m/min) 0.1m/min (range 100~500m/min)
	line length	0.02m
Accuracy	rotary speed	$\pm(0.4\%n+1d)$ RPM ($n<300$ RPM) $\pm(0.05\%n+1d)$ RPM ($n\geq 300$ RPM) n is rotary speed, d is resolution
	line speed	$\pm(1\%+1d)$ m/min d is resolution
	line length	$\pm(1\%+1d)$ m d is resolution
Sampling time	0.8s (above 60RPM)	
Operation temperature	0~40°C	
Power supply	3×AA batteries	
Dimension	171×71×35mm	
Weight	162g	

CONTACT TACHOMETER CODE 9224-213



cone cavity head (included)



clamping sleeve (included)



cone head (included)



small cone head (included)

STANDARD DELIVERY

Main unit	1 pc
Wheel with 0.1m perimeter	1 pc
Clamping sleeve	1 pc
Cone head	1 pc
Small cone head	1 pc
Cone cavity head	1 pc
Battery (AA)	3 pcs



wheel with 0.1m perimeter (included)



- Make cyclical motion (rotation, vibration, etc.) objects to appear slow-moving or stationary
- On-line inspection or observation for moving objects
- Measure the rotation or vibration speed and frequency
- Can be triggered from outside by moving objects, make LED flash frequency same as the rotation or vibration

SPECIFICATION

Flash frequency range	60~120000FPM (flash per minute), 1~2000Hz	
Resolution	FPM	0.1FPM (<100000FPM), 1FPM (≥ 100000 FPM)
	HZ	0.01Hz (<200Hz), 0.1Hz (≥ 200 Hz)
Setting accuracy	$\pm 0.01\%$	
Phase shift increment	3°	
Flash pulse duration time	0.1~2.5°	
LED light	3 pcs CREE 10W lamp	
LED life	3~5 years	
Trigger mode	internal and external	
Power supply	built-in rechargeable battery or AC/DC adapter	
Dimension	208×70×60mm	
Weight	380g	

STANDARD DELIVERY

Main unit	1 pc
AC/DC adapter	1 pc
Proximity trigger	1 pc

DIGITAL LED TACHOMETER/STROBOSCOPE CODE ISQ-TS120K



proximity trigger (included)

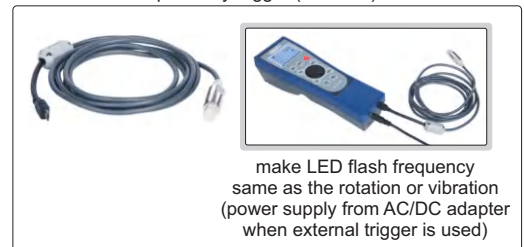

make LED flash frequency same as the rotation or vibration (power supply from AC/DC adapter when external trigger is used)

LASER VIBROMETER CODE 0030-LM15



reflective signal strength indicate

sensitivity setting

computer software (included): time-domain, frequency-domain, dual-display mode

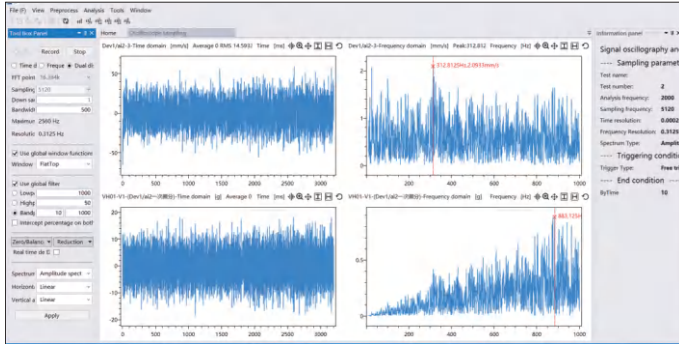

tripod (included)

34

- Non-contact measurement, no additional mass influence
- All-in-one design, integrated optical and electrical systems
- Manual focusing
- Computer software is included

SPECIFICATION

Laser		output<4mW, wavelength 632.8nm, class 3A laser product
Working distance		0.35mm~10m (depending on surface)
Speed decoder	bandwidth	DC~20kHz
	range	±50mm/s, ±500mm/s, ±5000mm/s (adjustable)
	maximum speed resolution *	0.1µm/s/√Hz
Maximum linearity error		±1%
Output voltage range		±10V
Output	digital signal	ethernet port
	analogue signal	BNC port
Low-pass filter		500Hz, 2kHz, 20kHz
Gear control and display		7-inch colour touchscreen with interactive menu-guided setting
Power supply		power adapter
Operation temperature		5°C~45°C
Storage temperature		-10°C~65°C
Dimension		382×160×94mm
Weight		5.2kg

* Maximum speed resolution is defined as the signal amplitude (RMS) measured at 10Hz with a signal-to-noise ratio of 0dB when a reflective film is applied at a distance of 2 meters

STANDARD DELIVERY

Main unit (including speed decoder)	1 pc
Tripod	1 pc
Power adapter	1 pc
Software	1 pc

OPTIONAL ACCESSORY

Laptop computer	0030-COMPUTER-E
------------------------	-----------------

VIBRATION METER CODE 0022-VM20

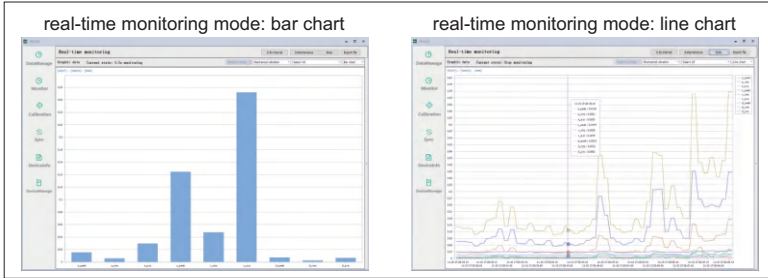

software (included), monitor and collect data to PC software via USB cable, data can sent to Excel



- Can measure vibration frequency
- Can measure virtual value/peak value/peak-peak value of acceleration, velocity and displacement
- Suitable for factory inspection, status monitoring and fault diagnosis of mechanical equipments such as motors, pumps, fans, household appliances, compressors, smoke machines, generators, gearboxes, etc.
- Software is included: on-line monitoring, data storage

SPECIFICATION

Measuring parameter	acceleration (virtual/peak/peak-peak value) $a_{RMS,1}$, $a_{Peak,1}$, $a_{P-P,1}$, a_{Peak} , a_{P-P}	velocity (virtual/peak/peak-peak value) $V_{RMS,1}$, $V_{Peak,1}$, $V_{P-P,1}$, V_{Peak} , V_{P-P}	displacement (virtual/peak/peak-peak value) $d_{RMS,1}$, $d_{Peak,1}$, $d_{P-P,1}$, d_{Peak} , d_{P-P}
Measuring range	0.01~200m/s ² (peak value)	0.1~200mm/s (virtual value)	0.01~2mm (peak-peak value)
Frequency range	10Hz~5kHz	10Hz~1kHz	10Hz~500Hz
Amplitude frequency reponse	±5%		
Amplitude linearity	±5%		
Frequency accuracy	±0.5%		
Cut-off frequency (second-order high-pass filtering)	8kHz sampling frequency: 3.16Hz、10.00Hz、31.60Hz、N/A (adjustable) 32kHz sampling frequency: 12.64Hz、40.00Hz、126.4Hz、N/A (adjustable)		
Display	1.96" 128×64 dot matrix OLED screen		
Language	Chinese, English, Portuguese		
Power	<80mA/5V		
Power supply	4×AAA batteries: 6.0V/1000mAh; AC/DC adapter: 5V/2A		
Operation condition	temperature: -10°C~50°C; humidity: 25%RH~90%RH, non-condensing; pressure: 65kPa~108kPa		
Dimension	172×69×26mm		
Weight	240g		

STANDARD DELIVERY

Main unit	1 pc
Software	1 pc
Accelerometer (including cable)	1 pc
Magnetic base	1 pc
M5 screw	1 pc
Battery (AAA)	4 pcs
AC/DC adapter	1 pc

OPTIONAL ACCESSORY

Tripod	0701-TR175
--------	------------

VIBRATION PEN (THREE PARAMETERS) CODE 0020-A199



- Acceleration, velocity and displacement can be tested
- Automatic power off



SPECIFICATION

Parameter	acceleration	velocity	displacement
Measuring range	0.01~199.9m/s ² (peak value)	0.01~199.9mm/s (virtual value)	0.001~1.999mm (peak~peak value)
Frequency	10Hz~1kHz	10Hz~1kHz	10Hz~500Hz
Frequency response	±5% (≥20Hz) -20%~+10% (<20Hz)		
Linearity	±(5%+2unit)		
Indeterminacy of sensitivity	≤3%		
Operation temperature	0°C~40°C/32°F~104°F		
Operation humidity	<85%		
Power supply	2×LR44 battery (for 10 hours working)		
Dimension	150x22x18mm		
Weight	55g		

STANDARD DELIVERY

Main unit	1 pc
LR44 battery	2 pcs

34

VIBRATION PEN CODE 9720-199



- Measure vibration of motors, fans, pumps, compressors and machine tools to prevent mechanical failure
- Small size, light weight, low energy consumption, easy operation, easy to carry
- One key control
- Automatic power off



SPECIFICATION

Measured parameter	speed
Measuring range	0.1~199.9mm/s
Frequency	10Hz~1kHz
Accuracy	±(5%±2)mm/s
Operation temperature	0°C~40°C
Operation humidity	<85%
Power supply	2×LR44 batteries (for 10 hours wroking)
Dimension	150x22x18mm
Weight	55g

STANDARD DELIVERY

Main unit	1 pc
LR44 battery	2 pcs



PORTABLE VIBRATION CALIBRATOR CODE 0021-AS159

- Quick, easy calibration and checking of vibration measurement, monitoring and recording system

SPECIFICATION

Frequency	159.2Hz±1%
Acceleration	10m/s ² ±3% (RMS)
Distortion	<5%
Transverse vibration	<5%
Warm-up time	<20s
Maximum load	70g
Mounting thread	M5×0.8mm
Operation temperature	0°C~40°C
Operation humidity	10%RH~90%RH, non-condensing
Power supply	rechargeable lithium battery, working time≥5h
Dimension	Ø54.5×147mm
Weight	620g



STANDARD DELIVERY

Main unit	1 pc
Power adapter	1 pc

POPULAR MODEL

- High accuracy models: **9561-50B, 9561-70B**
Low accuracy models: **9561-50B-F, 9561-70B-F**
- Large display with backlight
- Unit: m, ft, in, ft+in
- Distance, area, volume and height measurement
- Continuous measuring mode to track maximum and minimum value
- Memory of 30 measurement values
- Automatic power off: laser 30s, main unit 180s

LASER DISTANCE METERS



9561-50B

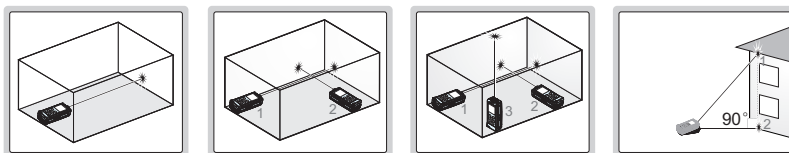

distance measurement area measurement volume measurement height measurement

SPECIFICATION

Code	9561-50B	9561-70B	9561-50B-F	9561-70B-F
Measuring range	0.2~50m	0.2~70m	0.2~50m	0.2~70m
Resolution	0.001m, 0.001ft, 1/16"			
Accuracy	±(3+D/20)mm D: measured distance, unit: m		±(5+D/20)mm D: measured distance, unit: m	
Laser type	red laser, 630~670nm, class II, <1mW			
Power supply	2×AAA batteries			
Dimension (L×W×H)	115×50×28mm			
Weight	95g			

STANDARD DELIVERY

Main unit	1 pc
Battery (AAA)	2 pcs

BLUETOOTH LASER DISTANCE METERS

BUILT-IN
BLUETOOTH



9564-D50

bluetooth connect to phone (APP)



34

- Built-in bluetooth, transmission distance is 10 meters (no obstacles, no electromagnetic interference)
- Built-in angle sensor
- Display with backlight
- Distance, area, volume and height measurement
- Continuous measuring mode to track maximum and minimum value
- Unit: m, ft, in, ft+in
- Memory of 20 measurement values
- Automatic power off: laser 30s, main unit 180s

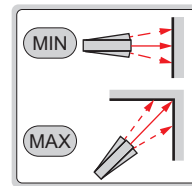

continuous measurement

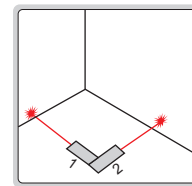

area measurement

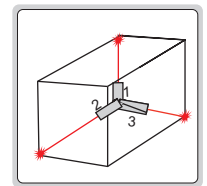

volume measurement

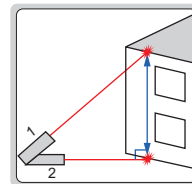

height measurement (1)

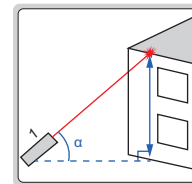

height measurement (2)

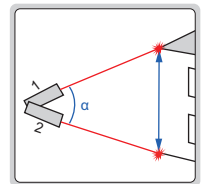

height measurement (3)

SPECIFICATION

Code	9564-D50	9564-D60
Measuring range	0.2~100m	0.2~120m
Resolution	0.001m	<100m: 0.001m 100~120m: 0.01m
Accuracy	$\pm(2+D/20)$ mm D: measured distance, unit: m	<100m: $\pm(2+D/20)$ mm 100~120m: ± 10 mm D: measured distance, unit: m
Laser type	490~670nm, class II, <1mW	
Accuracy of tilt angle*	$\pm(0.4^\circ+0.01^\circ \times T)$ T: operation temperature, unit: $^\circ\text{C}$	
Power supply	3×rechargeable batteries	
Operation temperature	0~40 $^\circ\text{C}$	
Dimension (L×W×H)	120×57×28mm	
Weight	125g	

* Angle between the laser beam and the horizontal line

STANDARD DELIVERY

Main unit	1 pc
Battery (AAA)	3 pcs

OPTIONAL ACCESSORY

Tripod	0701-TR175
--------	------------



BUILT-IN
BLUETOOTH

MINI LASER DISTANCE METER CODE 9565-E40

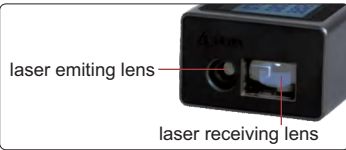

- Built-in bluetooth, transmission distance is 10 meters (no obstacles, no electromagnetic interference)
- Display with backlight
- Unit: m, ft, in, ft+in
- Distance, area, volume and height measurement
- Automatic power off: laser 30s, main unit 180s

SPECIFICATION

Measuring range	0.2~40m
Resolution	0.001m, 0.001ft, 1/16"
Accuracy	$\pm(3+D/20)$ mm, D: measured distance, unit: m
Laser type	red laser, 630~670nm, class II, <1mW
Charging interface	USB (type-C)
Dimension	180×28×40mm
Weight	53g

STANDARD DELIVERY

Main unit	1 pc
USB charging cable	1 pc

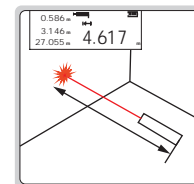

distance measurement

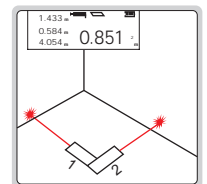

area measurement

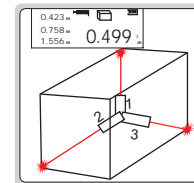

volume measurement

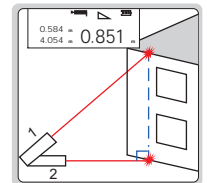

height measurement

bluetooth connect to phone (APP)



STROKE COUNTER CODE 7600-6

- Accumulate and record the number of mechanical movements
- Rotate back to zero



SPECIFICATION

Code	Number of digits	Range
7600-6	6	0-999999

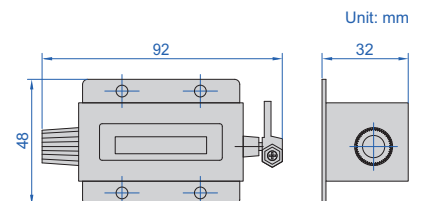

WATERPROOF DIGITAL STOPWATCH CODE DSW-B024

WATERPROOF

- Single row display with backlight
- Count up to 23 hours 59 minutes and 59 seconds
- 2 recallable memory
- Time and calendar display with hour, minute, second, month, date and day



34

SPECIFICATION

Chronograph	range	0~23 hours 59 minutes and 59 seconds
	resolution	0.01s (<30mins) 1s (>30mins)
	accuracy	±1.5s (day error)
Clock	display	12/24 hour format
	function	alarm and hourly chime
Waterproof level		3bar (30meters)
Operation environment *		0°C~50°C
Power supply		CR2032 battery
Dimension		76×64×22mm
Weight		62g

* Underwater button operation is not supported

STANDARD DELIVERY

Main unit	1 pc
String	1 pc

DIGITAL STOPWATCH CODE DSW-A010



- Split time, total time and continuous time can be displayed
- 10 groups of results can be read out from memory after resetting
- Scroll back and forth to read out the memory digits
- The fastest, slowest and average time can be displayed
- Able to record the split times (00-199)



SPECIFICATION

Measuring range		0~9 hours, 59 minutes, 59.99 seconds
Resolution		0.01s
Accuracy		±0.5s
Function	memory	10 groups
	timer	up to 10 hours
	time	12-hour or 24-hour time display, alarm can be set
Power supply		LR44 battery
Screen dimension		33.6×13.6mm
Dimension		76×63×16mm (metal case)

STANDARD DELIVERY

Main unit	1 pc
String	1 pc



DIGITAL MOISTURE METER CODE 9341-50

- Suitable for wood, smooth cement, hard gypsum, mixed mortar, brick, etc.
- Measure moisture, temperature and relative humidity
- Temperature type: ambient, dew point, wet bulb
- Maximum and minimum modes
- Automatic power off

SPECIFICATION

Measuring depth		0~50mm
Measuring range	moisture	0~60%
	temperature	-10~50°C/14~122°F
	relative humidity	0~100%RH
Accuracy	moisture	±2%
	temperature	±2%/±3.6°F
	relative humidity	±5%RH
Resolution	moisture	0.1%
	temperature	0.1°C/0.1°F
	relative humidity	0.1%RH
Sampling time		0.5s for moisture 1s for temperature and relative humidity
Power supply		2×AAA batteries
Dimension		130×56×29mm
Weight		206g



STANDARD DELIVERY

Main unit	1 pc
Battery (AAA)	2 pcs



INDUCTIVE MOISTURE METER CODE 0120-IM24

- Suitable for wood, gypsum and cement
- MAX/MIN/HOLD mode
- Alarm function
- Low battery indication
- Auto power off

SPECIFICATION

Measuring range	0~100%
Resolution	1%
Accuracy	±4%
Detection depth	20~40mm
Sampling time	0.5s
Power supply	9V battery
Dimension	185×55×38mm
Weight	193g



STANDARD DELIVERY

Main unit	1 pc
Battery	1 pc

DIGITAL PRESSURE CALIBRATORS



BACKLIGHT

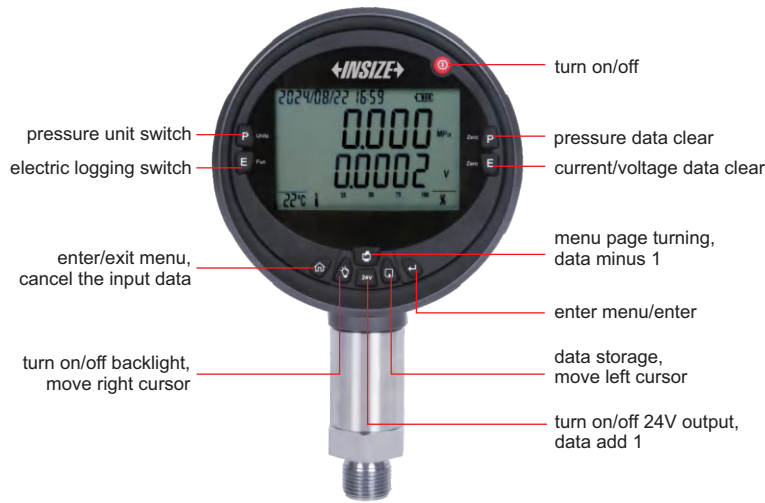

5240-M20Y600

- Calibration of general pressure gauges, precision pressure gauges, pressure transmitters, pressure switches, sphygmomanometers, pressure transducers and other pressure instruments and meters
- Large white backlight LCD display with multiple measurements shown at the same time
- With standard HART interface, built-in HART communication, It can calibrate HART pressure transmitter
- RS232 interface for uploading stored files
- 11 pressure units can be switched
- With automatic temperature compensation function
- With data storage function, the data will not be lost when the pressure calibrator is switched off
- Other additional functions: pressure percentage display, pressure leakage detection, multiple triggering of pressure switches, pressure peak recording, 24V DC output

Range*	Connection*		
	M20	G1/2	NPT1/2
(-100-0)kPa/(-1~0)bar	5240-M20Y010A	5240-G12Y010A	5240-N12Y010A
(0-100)kPa/(0~1)bar	5240-M20Y010	5240-G12Y010	5240-N12Y010
(0-160)kPa/(0~1.6)bar	5240-M20Y016	5240-G12Y016	5240-N12Y016
(0-250)kPa/(0~2.5)bar	5240-M20Y025	5240-G12Y025	5240-N12Y025
(0-400)kPa/(0~4)bar	5240-M20Y04	5240-G12Y04	5240-N12Y04
(0-600)kPa/(0~6)bar	5240-M20Y06	5240-G12Y06	5240-N12Y06
(0-1)MPa/(0~10)bar	5240-M20Y10	5240-G12Y10	5240-N12Y10
(0-1.6)MPa/(0~16)bar	5240-M20Y16	5240-G12Y16	5240-N12Y16
(0-2.5)MPa/(0~25)bar	5240-M20Y25	5240-G12Y25	5240-N12Y25
(0-4)MPa/(0~40)bar	5240-M20Y40	5240-G12Y40	5240-N12Y40
(0-6)MPa/(0~60)bar	5240-M20Y60	5240-G12Y60	5240-N12Y60
(0-10)MPa/(0~100)bar	5240-M20Y100	5240-G12Y100	5240-N12Y100
(0-16)MPa/(0~160)bar	5240-M20Y160	5240-G12Y160	5240-N12Y160
(0-25)MPa/(0~250)bar	5240-M20Y250	5240-G12Y250	5240-N12Y250
(0-40)MPa/(0~400)bar	5240-M20Y400	5240-G12Y400	5240-N12Y400
(0-60)MPa/(0~600)bar	5240-M20Y600	5240-G12Y600	5240-N12Y600

*Other ranges and connection can be customized according to customer requirements

STANDARD DELIVERY

Main unit	1 pc
Power adapter	1 pc
Current and voltage test line	1 set

OPTIONAL ACCESSORY

Pressure gauge pneumatic calibration pump	5220-PP06
Pressure gauge calibration pump	5230-HP□□□
Pressure adapter	5220-PA-□□□

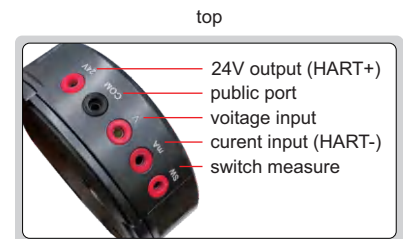

To be continued

Continued from previous page

SPECIFICATION

Accuracy	0.05%FS	
Overload pressure	120%FS	
Long-term stability	±0.1%FS/year	
Zero drift	±0.1%FS	
Dial diameter	120mm	
Pressure type	gauge pressure	
Unit	MPa, kPa, inHg, inH ₂ O, kgf/cm ² , mmH ₂ O, mmHg, mbar, bar, psi, Pa	
Electrical connection	measuring connection standard Ø4mm jack	
Current measurement	range	(-30~30)mA
	resolution	0.1µA
	accuracy	±(0.01%RD+0.003%FS)
Voltage measurement	range	(-30~30)V
	resolution	0.1µV
	accuracy	±(0.01%RD+0.003%FS)
Pressure switch-off measurement	voltage range 3V~24V (if with electric)	
Temperature measurement	range	0~50°C
	accuracy	±1°C
24V DC output	24V±0.5V, 50mA (max)	
Operation environment	work temperature	0~50°C
	humidity	(0~90%)RH (non-condensing)
	atmospheric pressure	0.86~1.01bar/(86~101)kPa
Data interface	RS232	
Power supply	rechargeable lithium battery, power adapter	
Dimension	header Ø120×45mm, overall length 190mm	
Weight	0.70kg	

**PRESSURE GAUGE PNEUMATIC CALIBRATION PUMP
CODE 5220-PP06**

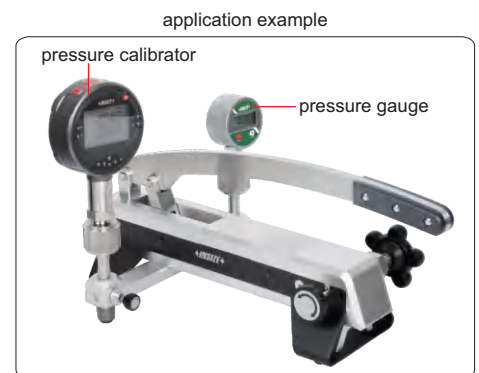
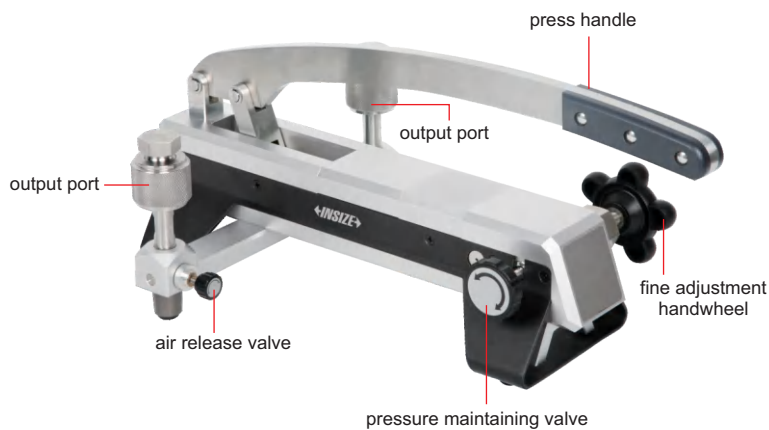

- Energy-saving operation
- Two quick-connect ports
- Screw type fine adjustment
- All parts are made of aluminium alloy
- Easy maintenance and repair

carrying case (optional)



SPECIFICATION

Pressure range	(-0.095~6)MPa (-0.95~70)bar/(-14~1000)psi
Adjustment resolution	10Pa
Output port	M20×1.5 female (Qty 2)*
Medium	air
Dimension (L×W×H)	450×262×170mm
Weight	5.5kg

STANDARD DELIVERY

Main unit	1 pc
O-ring	20 pcs

OPTIONAL ACCESSORY

Pressure calibrator	5240-□□□
Pressure calibration adaptor	5220-PA-□□□
Carrying case	5220-CASE

*Other output port (1/2G, 1/4G, 1/2NPT, 1/4NPT) can be customized

PRESSURE GAUGE CALIBRATION PUMPS

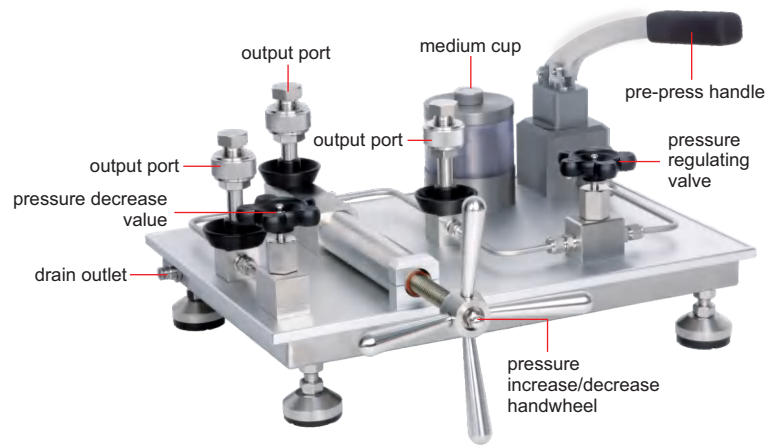
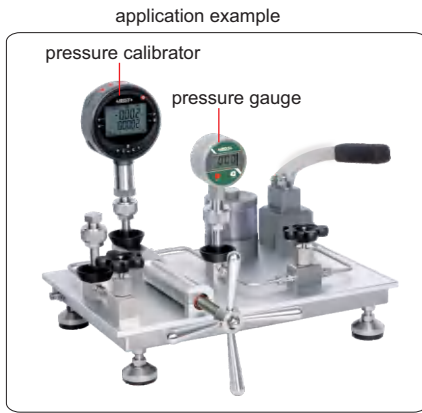

34

- Portable design for laboratory and industrial field use
- Three quick-connect ports, two pressure gauge can be calibrated at the same time
- Stable pressure increase/decrease
- Media drain design, to avoid the dirty media pollution of the system
- The parts are made of stainless steel, stable and reliable quality
- Overall open structure, easy to maintain and repair

5230-HP60W

carrying case (optional)



SPECIFICATION

Code	5230-HP60W	5230-HP60Y
Pressure range	(0~60)MPa/(0~600)bar/(0~9000)psi	
Adjustment resolution	0.1kPa	mineral oil
Medium	pure water	
Output port	M20×1.5 female (Qty 3)*	
Reservoir volume	0.38L	
Dimension (L×W×H)	465×370×240mm	
Weight	15kg	

STANDARD DELIVERY

Main unit	1 pc
O-ring	20 pcs

OPTIONAL ACCESSORY

Pressure calibrator	5240-□□□
Pressure calibration adaptor	5220-PA-□□□
Carrying case	5220-CASE

*Other output port (1/2G, 1/4G, 1/2NPT, 1/4NPT) can be customized

PRESSURE GAUGE ADAPTERS

- The adapters are designed for the conversion connection between different types and specifications of threads during the testing of pressure gauge
- The M20×1.5 male thread is converted to a variety of different specifications and types of threads, which can meet most of the conversion connection needs

5220-PA-SET



Set

Code	Including 38 adapters	Pressure range
5220-PA-SET	5220-PA-M20M, 5220-PA-M20F, 5220-PA-M16M, 5220-PA-M16F, 5220-PA-M14M, 5220-PA-M14F, 5220-PA-M12M, 5220-PA-M12F, 5220-PA-M10M, 5220-PA-M10F, 5220-PA-G12M, 5220-PA-G12F, 5220-PA-G38M, 5220-PA-G38F, 5220-PA-G14M, 5220-PA-G14F, 5220-PA-G18M, 5220-PA-G18F, 5220-PA-ZG12M, 5220-PA-ZG12F, 5220-PA-ZG38M, 5220-PA-ZG38F, 5220-PA-ZG14M, 5220-PA-ZG14F, 5220-PA-ZG18M, 5220-PA-ZG18F, 5220-PA-N12M, 5220-PA-N12F, 5220-PA-N38M, 5220-PA-N38F, 5220-PA-N14M, 5220-PA-N14F, 5220-PA-N18M, 5220-PA-N18F, 5220-PA-N18F, 5220-PA-6HB, 5220-PA-8HB, 5220-PA-10HB, 5220-PA-M20RA	(-1-250) bar

To be continued

Continued from previous page

Individual

Code	Specification
5220-PA-M20M	M20×1.5 male to M20×1.5 male
5220-PA-M20F	M20×1.5 male to M20×1.5 female
5220-PA-M16M	M20×1.5 male to M16×1.5 male
5220-PA-M16F	M20×1.5 male to M16×1.5 female
5220-PA-M14M	M20×1.5 male to M14×1.5 male
5220-PA-M14F	M20×1.5 male to M14×1.5 female
5220-PA-M12M	M20×1.5 male to M12×1.5 male
5220-PA-M12F	M20×1.5 male to M12×1.5 female
5220-PA-M10M	M20×1.5 male to M10×1.0 male
5220-PA-M10F	M20×1.5 male to M10×1.0 female
5220-PA-G12M	M20×1.5 male to G1/2 male
5220-PA-G12F	M20×1.5 male to G1/2 female
5220-PA-G38M	M20×1.5 male to G3/8 male
5220-PA-G38F	M20×1.5 male to G3/8 female
5220-PA-G14M	M20×1.5 male to G1/4 male
5220-PA-G14F	M20×1.5 male to G1/4 female
5220-PA-G18M	M20×1.5 male to G1/8 male
5220-PA-G18F	M20×1.5 male to G1/8 female
5220-PA-ZG12M	M20×1.5 male to ZG1/2 male

Code	Specification
5220-PA-ZG12F	M20×1.5 male to ZG1/2 female
5220-PA-ZG38M	M20×1.5 male to ZG3/8 male
5220-PA-ZG38F	M20×1.5 male to ZG3/8 female
5220-PA-ZG14M	M20×1.5 male to ZG1/4 male
5220-PA-ZG14F	M20×1.5 male to ZG1/4 female
5220-PA-ZG18M	M20×1.5 male to ZG1/8 male
5220-PA-ZG18F	M20×1.5 male to ZG1/8 female
5220-PA-N12M	M20×1.5 male to NPT1/2 male
5220-PA-N12F	M20×1.5 male to NPT1/2 female
5220-PA-N38M	M20×1.5 male to NPT3/8 male
5220-PA-N38F	M20×1.5 male to NPT3/8 female
5220-PA-N14M	M20×1.5 male to NPT1/4 male
5220-PA-N14F	M20×1.5 male to NPT1/4 female
5220-PA-N18M	M20×1.5 male to NPT1/8 male
5220-PA-N18F	M20×1.5 male to NPT1/8 female
5220-PA-6HB	M20×1.5 male to Ø6 hose barb
5220-PA-8HB	M20×1.5 male to Ø8 hose barb
5220-PA-10HB	M20×1.5 male to Ø10 hose barb
5220-PA-M20RA	M20×1.5 male to right angle M20×1.5 female

Gas pressure connection hose

Code	Application	Pressure range
5220-PA-GH	for remote calibration of gas pressure gauge, the gauge is connected to the calibrator	(-1-8) bar



5220-PA-GH

High gas pressure connection hose

Code	Application	Pressure range
5220-PA-HGH	for remote calibration of high gas pressure gauge, the gauge is connected to a calibrator	(-1-40) bar



5220-PA-HGH

High liquid pressure connection hose

Code	Application	Pressure range
5220-PA-LH	for remote calibration of high pressure liquid pressure gauge, the gauge is connected to the calibrator	(0-700) bar



5220-PA-LH

Gas-liquid separation filter

Code	Application	Pressure range
5220-PA-SF	when calibrating gauge with air pressure sources, the filter impurities and excludes oil	(-1-250) bar



5220-PA-SF

Liquid filter

Code	Application	Pressure range
5220-PA-LF	the filter impurities the pressure gauge lumen to prevent contamination of the pressure source	(0-700) bar



5220-PA-LF

Pressure gauge thread cleaner

Code	Application
5220-PA-TC	remove sealing wrappings such as twine and raw tape from threaded connections



5220-PA-TC

Oil-water separator

Code	Application
5220-PA-OWS	used to isolate the upper and lower two (or the same) liquid media, isolation film can also play a role in equipment maintenance and cleaning



5220-PA-OWS

DIGITAL PRESSURE GAUGES (DIAL DIAMETER 60mm)



BACKLIGHT

IP50
WATERPROOF

- The case is made of 304 stainless steel
- Large LCD screen, support unit switching
- Zero, backlight, on/off functions
- Pressure bar display, indicating current pressure percentage
- Built-in high-precision pressure sensor, high accuracy, high long-term stability
- Measurement of gases, liquids, oils and other media that do not corrode stainless steel
- Anti-electromagnetic interference design, conforms to EN61326 standard

Range *	Connection *		
	M14	G1/4	NPT1/4
(0-1.6) MPa	5202-M14Y16	5202-G14Y16	5202-N14Y16
(0-6) MPa	5202-M14Y60	5202-G14Y60	5202-N14Y60
(0-25) MPa	5202-M14Y250	5202-G14Y250	5202-N14Y250

* Other ranges and connection can be customized according to customer requirements

SPECIFICATION

Accuracy	1%FS	
Overload pressure	120% (≥ 10 MPa); 150% (< 10 MPa)	
Pressure type	gauge pressure	
Unit	MPa, kPa, psi, kgf/cm ² , bar	
Power supply	2×1.5V AAA batteries (for 12 months working)	
Operation environment	work temperature	-10~60°C
	humidity	(0~100%)RH (non-condensing)
	storage temperature	-10~50°C
Dial diameter	60mm	
Weight	0.23kg	



5202-M14Y60

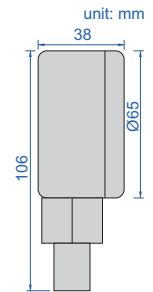

STANDARD DELIVERY

Main unit	1 pc
Battery (AAA)	2 pcs

DIGITAL PRESSURE GAUGES (DIAL DIAMETER 80mm)



BACKLIGHT

IP50
WATERPROOF

- The case is made of 304 stainless steel
- Large LCD screen, support unit switching
- Zero, backlight, on/off, Low voltage alarm, extreme value recording functions
- Pressure bar display, indicating current pressure percentage
- Built-in high-precision pressure sensor, high accuracy, high long-term stability
- Measurement of gases, liquids, oils and other media that do not corrode stainless steel
- Anti-electromagnetic interference design, conforms to EN61326 standard

Range *	Connection *		
	M20	G1/2	NPT1/2
(0-1.6) MPa	5203-M20Y16	5203-G12Y16	5203-N12Y16
(0-6) MPa	5203-M20Y60	5203-G12Y60	5203-N12Y60
(0-25) MPa	5203-M20Y250	5203-G12Y250	5203-N12Y250

* Other ranges and connection can be customized according to customer requirements

SPECIFICATION

Accuracy	0.5%FS	
Overload pressure	150% (> 10 MPa); 200% (≤ 10 MPa)	
Pressure type	gauge pressure	
Unit	MPa, kPa, psi, kgf/cm ² , bar, mH ₂ O, inHg	
Power supply	2×1.5V AAA batteries (for 12 months working)	
Operation environment	work temperature	-10~60°C
	humidity	(0~100%)RH (non-condensing)
	storage temperature	-10~50°C
Dial diameter	80mm	
Weight	0.38kg	



5203-M20Y60

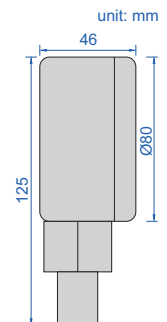

STANDARD DELIVERY

Main unit	1 pc
Battery (AAA)	2 pcs

CAN BE
CUSTOMIZED

BOURDON TUBE PRESSURE GAUGES (LIQUID FILLED)

- Stainless steel case and bezel, copper alloy internals
- Shock-proof and pulse-proof
- Suitable for pneumatic systems, hydraulic systems and compressed air systems

Dial size	Ø63mm		
Process connection	1/4BSP	1/4ZG	1/4NPT
Connector location	bottom	bottom	bottom
Range (0~10bar/0~150psi)	5201-63B2Y10	5201-63Z2Y10	5201-63N2Y10



5201-63B2Y10

SPECIFICATION

Accuracy class	1.6
Ambient temperature	-20~60°C
Medium temperature	≤60°C

34

RADIATION DETECTOR CODE 0522-RF10

- Detect X ray,* β ray, γ ray radiation
- Measure radiation dose rate in real-time and record cumulative dose at the same time, display real-time dose rate curve
- Adjustable dose rate alarm and dose alarm threshold
- Data stored in built-in memory will not lose after power off
- Particle sound switch
- LCD display with backlight
- Battery level display and low battery indication
- Language: English, Chinese



SPECIFICATION

Sensor	glass Geiger counter tube
Dose rate range	0.1μSv/h~10mSv/h
Dose range	0.00μSv~10Sv
Relative error	<10% (at 1mSv/h)
Sensitivity	>1cps/μSv/h (relative to ⁶⁰ Co)
Energy response	48keV~1.5MeV
Working environment	-10°C~50°C
Power supply	3×1.5V AAA batteries or USB-C
Power	<60mW
Dimension	116×60×33mm
Weight	145g

* X ray radiation measurement is for reference only, cannot meet the energy response requirement

STANDARD DELIVERY

Main unit	1 pc
-----------	------

EDDY CURRENT CONDUCTIVITY TESTER CODE 0420-EL60

DATA
OUTPUT

INSPECTION
CERTIFICATE



- Measure conductivity (MS/m, %IACS) and resistivity ($\Omega \cdot \text{mm}^2/\text{m}$) of non-ferromagnetic metals or alloys with eddy current phase detection
- With temperature compensation, even when the temperature of the calibration block and the material are different, test results can be automatically compensated
- Lift-off compensation function ensures accurate results when there are non-conductive layers such as coatings, dust, rough surfaces, etc., and reduces measurement error caused by operation as well
- Measure with high speed and efficiency, results show on screen after probe touch with the material in 1 second
- Data can be saved manually or automatically and exported to Excel with computer software
- Wear-resistant and heat-resistant probe
- Unit switch
- Display with backlight
- Language: English, Chinese, Japanese



probe
(included)

SPECIFICATION

Conductivity	range	0.3MS/m~65MS/m or 0.51%IACS~112%IACS
	unit	MS/m, %IACS
	resolution	0.01 (<30MS/m or <30%IACS) 0.1 (30MS/m~65MS/m or 30%IACS~112%IACS)
Resistivity	accuracy	$\pm 0.5\%$ (20°C); $\pm 1\%$ (0°C~50°C)
	range	0.01538 $\Omega \cdot \text{mm}^2/\text{m}$ ~3.33333 $\Omega \cdot \text{mm}^2/\text{m}$
	unit	$\Omega \cdot \text{mm}^2/\text{m}$
Temperature	resolution	0.00001 $\Omega \cdot \text{mm}^2/\text{m}$
	accuracy	$\pm 0.5\%$ (20°C); $\pm 1\%$ (0°C~50°C)
	range	0°C~50°C
	resolution	0.1°C
	accuracy	$\pm 0.5\%$
Test frequency	60kHz sinewave	
Probe diameter	$\varnothing 14\text{mm}$	
Lift-off compensation	maximum 500 μm	
Storage capacity	16000 groups	
Interface	USB, RS232 protocol	
Calibration block	about 0.60MS/m, 4.10MS/m, 58.0MS/m refer to values marked on the supplied blocks	
Operation environment	temperature: 0°C~50°C humidity: <95%RH, no condensation	
Power supply	3.7V rechargeable Li-ion battery	
Dimension	230×97×60mm	
Weight	370g	



calibration blocks
(included)



USB cable (included)

STANDARD DELIVERY

Main unit	1 pc
Probe (0420-TP01)	1 pc
Calibration block (0420-CB01)	3 pcs
USB cable	1 pc
AC/DC adapter	1 pc



DATA
OUTPUT



0501-MA01

radial probe
(included)



standard magnet
(optional)



magnetic shielding cavity
(optional)



axial probe (optional)

- Measure magnetic induction of DC magnetic field
- Directly display the N/S polarity of the measured magnetic field
- One-key zero function: eliminate the influence of zero drift before measurement
- Maximum value hold: record the maximum value of the changing magnetic field
- Unit switch between mT or G (1mT=10G)
- Auto ranging
- Built-in USB interface for data transmission
- Display with backlight
- Auto power off

SPECIFICATION

Code	0501-MA01	0501-MA05
Range	2000mT	
Resolution	0.01mT (0~200mT) 0.1mT (200mT~2000mT)	
Accuracy	±1.0%	±2.0% (≤1000mT) ±5.0% (1000mT~2000mT)
Temperature coefficient	±0.1%/K	
Zero drift	±0.5mT/h	
Interface	USB	
Power supply	3×1.5V AA batteries or USB	
Dimension (L×W×H)	165×90×40mm	
Weight	350g	

STANDARD DELIVERY

Main unit	1 pc
Radial probe (0501-PR)	1 pc
Battery (AA)	3 pcs

OPTIONAL ACCESSORY

Axial probe	0501-PA
Magnetic shielding cavity	0501-SHIELD
Standard magnet	0501-CT□□□, for verifying accuracy, not for calibration (□□□ is DC magnetic field specification, 100~600mT customizable)

AC/DC TESLAMETERS

DATA
OUTPUT



axial probe (optional)



0502-MC01

- Switch between DC or AC measurement mode
- Display N/S polarity of DC magnetic field
- Zero function: eliminate the influence of zero drift before measurement
- Maximum value hold: record the maximum value of the changing magnetic field
- Auto ranging
- Relative measurement mode
- Set upper and lower alarm limit
- Built-in USB interface for data transmission
- Display with backlight
- Auto power off

SPECIFICATION

Code	0502-MC01	0502-MC02
Range	2500mT	
Resolution	0.001mT (<30mT) 0.01mT (30~300mT) 0.1mT (300~2500mT)	
Unit	mT, G, Oe, kA/m (1mT=10G=10Oe=0.8kA/m)	
Accuracy	DC: ±1.0% AC: ±5.0%	DC: ±2.0% AC: ±5.0%
Frequency range	DC, 40~500Hz	
Temperature coefficient	±0.1%/K	
Zero drift	±0.1mT/h	
Interface	USB	
Operation environment	temperature: 0°C~45°C; humidity: 20%~80%RH, non-condensing	
Storage environment	temperature: -20°C~70°C; humidity: <85%RH, non-condensing	
Power supply	3×1.5V AA batteries or USB	
Dimension (L×W×H)	165×90×40mm	
Weight	350g	

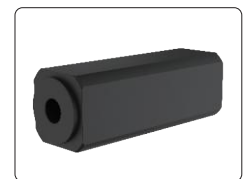

magnetic shielding
cavity (optional)



standard magnet
(optional)

STANDARD DELIVERY

Main unit	1 pc
Radial probe (0502-PR)	1 pc
Battery (AA)	3 pcs

OPTIONAL ACCESSORY

Axial probe	0502-PA
Magnetic shielding cavity	0501-SHIELD
Standard magnet	0501-CT□□□, for verifying accuracy, not for calibration (□□□ is DC magnetic field specification, 100~600mT customizable)



LIGHT TRANSMITTANCE METER CODE 5804-LT21

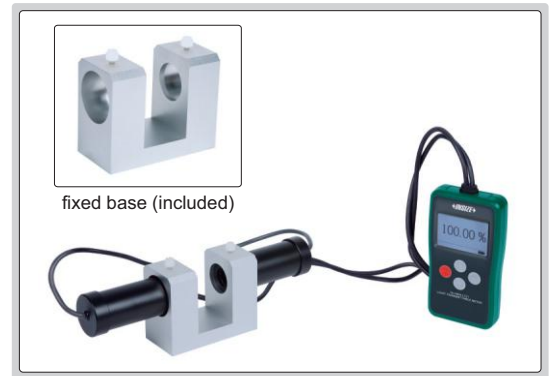

- Suitable for light transmittance testing of various “regular transmission materials”, such as building glasses, auto glasses, transparent films, plastic products, etc.
- With the design of parallel optical path of the light source and condensed light of the receiver, it can measure up to 100mm thickness
- Can measure the high transparent materials such as K9 glasses
- Two measuring modes, fixed base and handheld
- Conforming to CIE photopic luminosity function

regular transmission

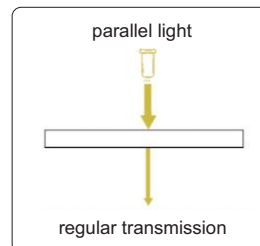

when the light penetrates a flat and evenly textured transparent material, the light does not change its direction

diffused transmission

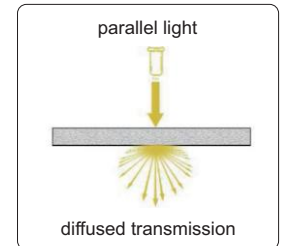

when the light penetrates a material with a rough surface or uneven texture, the light spreads out

SPECIFICATION

Optical source	380nm~760nm, conforming to CIE photopic luminosity function
Measuring range	0.001%~99.8%
Accuracy	±1%
Resolution	0.001% (0%~10%) , 0.01% (10%~100%)
Thickness to be measured	<100mm
Diameter to be measured	>10mm
Power supply	4×1.5V AAA batteries
Dimension	75×140×25mm
Weight	634g

STANDARD DELIVERY

Main unit	1 pc
Transmitter	1 pc (connect to main unit)
Receiver	1 pc (connect to main unit)
Fixed base	1 pc
1.5V AAA battery	4 pcs

DIGITAL GLASS THICKNESS METER CODE 5805-GT22



- Laser reflection principle to measure the thickness of glass and internal air layer. Especially suitable for building laminated glasses, hollow glass windows, etc.
- To test the thickness of single layer glasses, multi-layer glasses, two glasses with one cavity, three glasses with two cavities, laminated glasses, laminated insulating glasses, etc.

34

SPECIFICATION

Measuring range	glass thickness (0~70mm), air layer (0~45mm)
Accuracy	±0.1mm (measuring range≤63mm), ±0.2mm (measuring range>63mm)
Resolution	0.01mm
Display	LCD
Power supply	4×1.5V AAA batteries
Dimension	130×72×33mm
Weight	330g

STANDARD DELIVERY

Main unit	1 pc
Cross screwdriver	1 pc
1.5V AAA battery	4 pcs

TRIPOD CODE 0701-TR175



- Detachable three-dimensional gimbal
- Adjustable height

SPECIFICATION

Height	47cm~175cm (adjustable)
Load	3kg
Material of foot tube	aluminum alloy
Dimension	500×130×130mm
Weight	1.23kg

STANDARD DELIVERY

Main unit	1 pc
-----------	------



Infrared Thermal Imaging Cameras
Page 1106-1109



Infrared Thermometers
Page 1110-1112



Blackbody Radiation Sources
Page 1113



Infrared And Penetration
Thermometers
Page 1113



Multi-channel Temperature Loggers
Page 1114-1115



Thermocouple Thermometers
Page 1116-1117



Thermometers
Page 1117-1118



Data Loggers For Temperature And
Humidity
Page 1119-1120



Thermohygrometers
Page 1121-1122



Thermohygrometers
Page 1123



Large Screen Temperature And
Humidity Meters
Page 1124



Temperature And Humidity
Data Loggers
Page 1125-1126



Portable Temperature Dry Block Calibrators
Page 1126



Differential Pressure Manometers
Page 1127



Anemometers
Page 1128



Hot Wire Anemometers
Page 1129



Sound Level Meters
Page 1130-1132



Light Meters
Page 1133-1134



UV Light Meters
Page 1134-1135



DATA
OUTPUT

IP54
WATERPROOF

INFRARED THERMAL IMAGING CAMERA (BASIC TYPE) CODE 9132-T400

- Suitable for electric power, mechanical and electrical, heating ventilation and air conditioning, intelligent manufacturing, etc.
- High-sensitive infrared detector, resolution 256x192
- Support real-time super resolution technology, 4 times better image quality
- -20°C~550°C wide temperature measurement range, automatic switch
- Software is included: support file management, thermal image analysis, video analysis, report editing, etc.
- Mobile APP is included: support real-time data and video transmission

STANDARD DELIVERY

Main unit	1 pc
Power adapter	1 pc
TYPE-C data cable	1 pc
4G USB flash disk	1 pc
Software	1 pc

OPTIONAL ACCESSORY

Tripod	0701-TR175
--------	------------



35

SPECIFICATION

Imaging and optics	detector type	unrefrigerated vanadium oxide, 7.5μm~14μm
	infrared resolution	256×192@12μm
	super resolution	upgrade to 512×384
	thermal sensitivity/NETD	45mK
	infrared frame rate	25Hz/9Hz
	focal length	3.2mm
	field of view	56°×48°
	spatial resolution/IFOV	3.75mrad
	minimum object distance	0.1m
	distance to spot size/D:S	266:1
focusing mode	focus-free	
Measurement and analysis	measurement range	support auto-switching: -20°C~150°C, 0°C~550°C
	measurement accuracy	±2°C or ±2%, whichever is greater
	analyzed target	center spot, fixed temperature measurement areas: small/medium/large
	temperature alarm	full screen temperature alarm with image and flash
	temperature measuring parameter	emissivity, reflected temperature, target distance
Image display	display screen	2.4" LCD
	image mode	IR, VIS, MIF, PIP
	color palette	6: iron red, white hot, arctic, rainbow 1, rainbow 2, hot iron
	image adjustment	level span mode: automatic, semi-automatic, manual
	digital camera	2MP
Function	laser	laser indication
	recording function	photo and video
Storage and transmission	storage	built-in 16GB
	image storage	JPG with temperature information
	video storage	support real-time video transmission, IRGD with temperature information
	external interface	TYPE-C, 1/4" tripod interface
	WIFI	can be connected to the mobile terminal for image and real-time video transmission
Power supply	battery type	rechargeable lithium-ion battery, non-removable
	operation time	11 hours
	charging mode	TYPE-C charging, capable of charging while using
	charging time	90% of full charge in 2.5 hours
Environmental parameter	operation temperature	-15°C~50°C
	protection	IP54, 2m drop test
	certification	CE, ROHS
Physical parameter	weight	375g
	dimension	194×61.5×76mm

front view



INFRARED THERMAL IMAGING CAMERA CODE 0231-IC650

DATA
OUTPUT

IP54
WATERPROOF



35

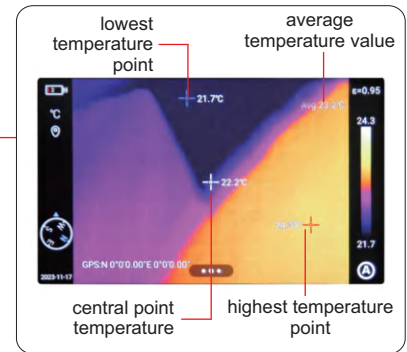

- Suitable for electric power, metallurgy, petrochemical, scientific research and teaching, manufacturing, rail transit, building testing, electronic equipment overhaul, mechanical equipment maintenance, etc.
- Four image presentation: IR, VIS, MIF, PIP
- Real-time image can be photographed and video recorded
- Software is included: image browsing, image parameter editing, infrared image analysis, batch report generation, video editing, etc.
- WIFI real-time sharing, one-click connection to mobile device

SPECIFICATION

Imaging and optics	detector type	unrefrigerated vanadium oxide/7.5μm~14μm
	infrared resolution	256×192@12μm
	super resolution	upgrade to 512×384
	thermal sensitivity/NETD	<45mK
	infrared frame rate	30Hz/9Hz
	focal length	10.5mm
	field of view	25°×19°
	spatial resolution (IFOV)	1.7mrad
	minimum object distance	0.1m
	distance to spot size (D:S)	588:1
	focusing mode	manual/automatic/continuous autofocus
	digital zoom	1.1X~8X
	shot recognition	auto
	laser ranging	indication/ranging: 0.1m~40m
Measurement and analysis	measurement range	support auto-switching: -40°C~150°C, 0°C~650°C
	measurement accuracy	±2°C or ±2%, whichever is greater
	analyzed target	spot×5, line×5, area×5
	tracking/alarm	full screen maximum, minimum and average temperature tracking; the maxium, minimum and average temperature tracking of analyzed target; full screen temperature threshold alarm (image, voice and flash)
	temperature measuring parameter	emissivity, reflected temperature, target distance, humidity, atmospheric transmittance, optical transmittance, dew point
	other	isothermals, smart stroke, intelligently calculate the area

To be continued



Continued from previous page

Image display	display screen	4.3", 800×480 pixel touch screen LCD
	digital camera	5MP
	image mode	IR, VIS, MIF, PIP
	image adjustment	level span mode: automatic, semi-automatic, manual
	color palettes	white hot, iron red, arctic, rainbow 2, hot iron, rainbow 1, fulgurite, medical, tint, black hot, blue hot, sepia, green hot, ice and fire, amber, customized
Function	recording function	photo and video (infrared & visible light)
	cloud service	available
	other	customized physical button, intelligent diagnosis, OTA update
Storage and transmission	storage	local storage (64GB) and external 64GB SD
	image storage	JPG with temperature information
	video storage	MP4 (without temperature information), can be used to record audio synchronously; irgd (with temperature information), up to 30Hz for temperature analysis
	external interface	TYPE-C, SD card slot
	WIFI	can be connected to the mobile terminal for image and real-time video transmission
	bluetooth	bluetooth 5.0, support image transmission (only for Android)
Power system	battery type	lithium-ion rechargeable battery, working time≥5 hours
	charging mode	TYPE-C charging; PC/portable charger; capable of charging while using
	charging time	90% of full charge in 2.5 hours
Environmental parameter	operation temperature	-20°C~50°C
	storage temperature	-40°C~60°C
	protection	IP54, 2-meter drop test
	certification	CE, FCC, ROHS
Physical parameter	hardware	illuminator, microphone, speaker, electronic compass, GPS
	dimension	292×125×125mm
	weight	1.15kg

35

STANDARD DELIVERY

Main unit	1 pc
64G SD card	1 pc
Lithium-ion battery	2 pcs
Desktop charger	1 pc
Power adapter	1 pc
Software	1 pc

OPTIONAL ACCESSORY

Tripod	0701-TR175
--------	------------

DATA
OUTPUT

IP54
WATERPROOF

**POCKET-SIZED THERMAL CAMERA
CODE 0232-PC550**



To be continued

Continued from previous page

- The 256×192 infrared detector produces crisp image
- The IR, VIS, PIP and MIF reveal temperature details
- -20°C to 550°C temperature range with auto-switching capability
- Software is included

SPECIFICATION

Imaging and optics	detector type	unrefrigerated vanadium oxide/7.5μm~14μm
	infrared resolution	256×192@12μm
	thermal sensitivity/NETD	≤45mK
	infrared frame rate	25Hz/9HZ
	focal length	3.2mm
	field of view	56°×48°
	spatial resolution (IFOV)	3.75mrad
	minimum object distance	0.3m
	distance to spot size (D:S)	266:1
	focusing mode	focus-free
	digital zoom	1.1x~8x
	laser ranging	≤8m
Measurement and analysis	measurement range	support auto-switching: -20°C~150°C, 100°C~550°C
	measurement accuracy	±2°C or ±2%, whichever is greater
	analyzed target	spot×2 (include center spot), area×3
	tracking/alarm	full screen maximum/minimum temperature tracking; the maximum or minimum temperature tracking of analyzed target; full screen temperature threshold alarm (image and flash)
	temperature measuring parameter other	emissivity, reflected temperature, target distance intelligently calculate the area
Image display	display screen	3.5" LCD
	digital camera	5MP
	image mode	IR, VIS, MIF, PIP
	image adjustment color palettes	level span mode: automatic, semi-automatic, manual white hot, black hot, iron red, hot iron, rainbow, arctic
Function	recording function	photo
	cloud service	available
	other	customized physical button×2
Storage and transmission	storage media	local storage (16GB)
	image storage	JPG with temperature information
	external interface	TYPE-C
	WIFI	can be connected to the mobile terminal for image transmission
Power system	battery type	rechargeable lithium-ion battery, working time≥4 hours
	charging mode	TYPE-C charging; PC/portable charger; capable of charging while using
	charging time	90% of full charge in 2.5 hours
Environmental parameter	operation temperature	-10°C~50°C
	storage temperature	-40°C~70°C
	protection	IP54, 1m drop test
	certification	CE, FCC, ROHS
Physical parameter	hardware	illuminator, Laser (indication, ranging)
	dimension	138×89×35mm
	weight	296g

STANDARD DELIVERY

Main unit	1 pc
Power adapter	1 pc
Software	1 pc

OPTIONAL ACCESSORY

Tripod	0701-TR175
--------	------------



**POPULAR
MODEL**

INFRARED THERMOMETER (BASIC TYPE) CODE 0222-C520

- Unit: °C, °F
- Automatic data hold
- MAX/MIN/AVG/DIF mode
- High and low alarm
- Adjustable emissivity
- Low battery display
- Over range indicator
- Automatic power off

SPECIFICATION

Temperature range	-50°C~500°C/-58°F~932°F
Temperature accuracy	±3.0°C (at -50°C~0°C), ±2.0°C or ±2% (at 0°C~500°C) ±5.4°F (at -58°F~32°F), ±4.0°F or ±2% (at 32°F~932°F)
Temperature resolution	0.1°C/0.2°F
Distance to spot size (D:S)	12:1
Emissivity	0.10~1.00 (adjustable)
Repeatability	±0.5°C or ±0.5%; ±1.0°F or ±0.5%
Response time	≤500ms (95% of reading)
Spectral response	8μm~14μm
Positioning laser	single-spot, class 2 laser product, output<1mW, wavelength 630nm~670nm
Power supply	2×AAA batteries, working time≥6h
Automatic power off	about in 15 seconds
Operation environment	temperature: 0°C~50°C/32°F~122°F; humidity: <90%RH (non-condensing)
Storage environment	temperature: -20°C~60°C/-4°F~140°F; humidity: <90%RH (non-condensing)
Dimension	148×85×46mm
Weight	160g



STANDARD DELIVERY

Main unit	1 pc
Battery (AAA)	2 pcs

35

INFRARED THERMOMETER (STANDARD TYPE) CODE 0213-A500

- Unit: °C, °F
- Dual-spot laser sighting
- Negativity display
- Automatic power off
- Automatic data hold
- Over range indicator
- Max/Min display

SPECIFICATION

Temperature range	-20°C~380°C/-4°F~716°F
Temperature accuracy	±2.5°C (at -20°C~20°C), ±2% or ±2.0°C (at 20°C~380°C) ±4.5°F (at -4°F~68°F), ±2% or ±3.6°F (at 68°F~716°F)
Temperature resolution	0.1°C/0.1°F
Distance to spot size (D:S)	12:1
Emissivity	0.95 (fixed)
Repeatability	±1°C/1.8°F
Response time	150ms
Spectral response	8μm~14μm
Positioning laser	dual-spot, class 2 laser product, output<1mW, wavelength 630nm~670nm
Operation temperature	0°C~50°C/32°F~122°F
Operation humidity	10%RH~90%RH
Storage temperature	-10°C~60°C/14°F~140°F
Storage humidity	<80%RH
Power supply	1×9V battery
Dimension	137×73×38mm
Weight	135g



STANDARD DELIVERY

Main unit	1 pc
Battery	1 pc

INFRARED THERMOMETER (MEDIUM TEMPERATURE TYPE) CODE 0215-A900

- Ambient temperature, dew point temperature and humidity detection
- Unit: °C, °F
- Circular laser sighting
- Display backlight
- Automatic power off
- Automatic data hold
- Adjustable emissivity
- High and low alarm

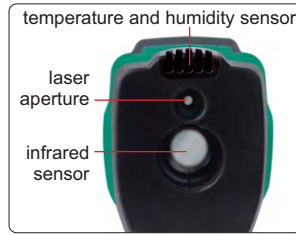

SPECIFICATION

Infrared sensor	temperature range	-30°C~800°C/-22°F~1472°F
	temperature resolution	0.1°C
	temperature accuracy	0.1°F (-22°F~1000°F), other range 1°F
		±3.0°C (at -30°C~20°C) ±(1% of reading +1)°C (at 20°C~450°C) ±(2% of reading)°C (at 450°C~800°C)
	distance to spot size (D:S)	20:1
	emissivity	0.10~1.00 (adjustable)
	response time	<150ms
	spectral response	8µm~14µm
positioning laser	circular, class 2 laser product, output<1mW, wavelength 630nm~670nm	
Temperature and humidity sensor	ambient temperature range	0°C~50°C/32°F~122°F
	dew point temperature range	0°C~50°C/32°F~122°F
	temperature resolution	0.1°C/0.1°F
	temperature accuracy	±1.0°C/±1.8°F
	humidity range	0%RH~100%RH
	humidity resolution	0.1%RH
humidity accuracy	±5%RH (20%RH~80%RH), other range ±7%RH	
Automatic power off	about in 10 seconds	
Power supply	1×9V battery	
Dimension	170×45×85mm	
Weight	196g	

STANDARD DELIVERY

Main unit	1 pc
Battery	1 pc

INFRARED THERMOMETER (MEDIUM-HIGH TEMPERATURE TYPE) CODE 0216-B210

- Unit: °C, °F
- Circular laser sighting
- Over range indicator with LED and buzzer
- 99 data storage
- Auto interval measurement
- MAX/MIN/AVG/DIF display



SPECIFICATION

Temperature range	-32°C~1300°C
Temperature accuracy	±(1.5+0.1· t)°C (<0°C), ±1.5°C or ±1.5% (≥0°C)
Temperature resolution	0.1°C (<1000°C), 1°C (≥1000°C)
Distance to spot size (D:S)	30:1
Emissivity	0.10~1.00 (adjustable)
Repeatability	0.7°C or 0.7%
Response time	≤250ms (95% of reading)
Spectral response	8µm~14µm
Positioning laser	circular, class 3R laser product, output 1mW≤P<3mW, wavelength 630nm~670nm
Operation temperature	0°C~50°C
Operation humidity	<90%RH (non-condensing)
Storage temperature	-20°C~60°C
Power supply	1×9V battery
Dimension	190×127×54mm
Weight	310g

STANDARD DELIVERY

Main unit	1 pc
Battery	1 pc

OPTIONAL ACCESSORY

Tripod	0701-TR175
--------	------------

DATA
OUTPUT

INFRARED THERMOMETER (HIGH TEMPERATURE TYPE) CODE 0218-B610

computer software (included):
connect to software via USB cable to collect, display and stored data

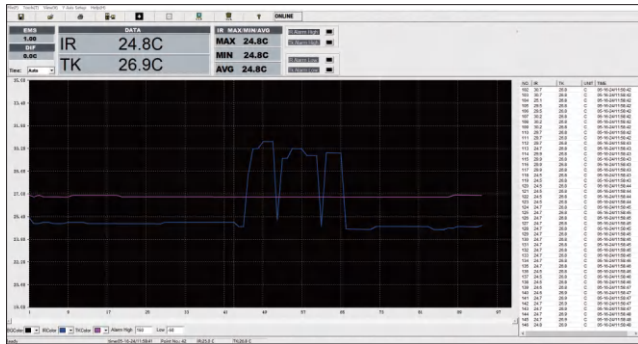

- Unit: °C/°F
- MAX/MIN/AVG/DIF mode
- Trigger lock continuous measurement function
- Adjustable emissivity: 0.10~1.00
- 100 data storage
- High and low alarm
- Automatic data hold
- Low battery display
- Automatic power off
- Computer software is included



tripod (included)



K-type thermocouple (included)

SPECIFICATION

Infrared system	temperature range	-50°C~1850°C/-58°F~3362°F
	temperature accuracy	±(2%· t +3.0°C) (at -50°C~20°C); ±(1%·t+1.0°C) (at 20°C~500°C); ±1.5% (at 500°C~1000°C); ±2.0% (at 1000°C~1850°C)
	temperature resolution	0.1°C/°F (<1000°C/°F), 1°C/°F (≥1000°C/°F)
	distance to spot size (D:S)	50:1
	emissivity	0.10~1.00 (adjustable)
	repeatability	±1.5°C (at -50°C~20°C), ±0.5% or ±0.5°C (at 20°C~1850°C)
	response time	150ms
	spectral response	8μm~14μm
K-Type thermocouple system (electrical signal)	positioning laser	dual-spot, class 2 laser product, output<1mW, wavelength 630nm~670nm
	temperature range	-50°C~1370°C/-58°F~2498°F
	temperature accuracy	±(1.5%· t +3°C) (at -50°C~1000°C) ±(1.5%·t+2°C) (at 1000°C~1370°C)
	temperature resolution	0.1°C/°F (<1000°C/°F), 1°C/°F (≥1000°C/°F)
Power supply	repeatability	±1.5%
Operation environment	1×9V battery	
Storage environment	temperature: 0°C~50°C humidity: 10%RH~90%RH (non-condensing)	
	temperature: -10°C~60°C humidity: <80%RH (non-condensing)	
Dimension	204×155×52mm	
Weight	315g	

STANDARD DELIVERY

Main unit	1 pc
9V battery	1 pc
USB cable	1 pc
K-type thermocouple	1 pc
Tripod	1 pc

SPECIFICATION OF K-TYPE THERMOCOUPLE

Temperature range	-40°C~250°C
Temperature accuracy	±2.5°C
Length	1m

DUAL-CAVITY BLACKBODY RADIATION SOURCE CODE PIC-D155



SPECIFICATION

Temperature range	low range: -15°C~100°C; high range: 50°C~500°C
Resolution	0.01°C (at -15°C~100°C), 0.1°C (at 100°C~500°C)
Stability	≤(0.1°C or 0.1% t , whichever is greater)/10min*
Uniformity	≤(0.15°C or 0.15% t , whichever is greater)*
Emissivity	>0.995
Cavity size	low range: Ø65mm; high range: Ø50mm
Cavity depth	low range: 110mm; high range: 160mm
Cool down time	30 minutes from ambient to -15°C
Heat up time	60 minutes from ambient to 500°C
Power supply	220V/50Hz
Power	850W
Dimension	380×295×320mm
Weight	17.1kg

*|t| is the absolute temperature value of blackbody radiation source

- Large target sizes of 50mm and 65mm for calibrating of infrared thermometers and infrared thermal imagers
- Contain two independent blackbody cavities
- The emissivity of blackbody radiation is better than 0.995
- 0.1 level temperature control meter with high accuracy
- Multi-point temperature correction function

STANDARD DELIVERY

Main unit	1 pc
-----------	------

INFRARED AND PENETRATION THERMOMETER CODE 0321-IT42

IP65
WATERPROOF



SPECIFICATION

Infrared system	temperature range	-15°C~280°C/5°F~536°F
	temperature resolution	0.1°C/0.1°F
	temperature accuracy	±3.0°C (at -15°C~20°C), other range ±(1%+1.0)°C ±5.4°F (at 5°F~68°F), other range ±(1%+1.8)°F
	distance to spot size (D:S)	4:1
	emissivity	0.95 (fixed)
Penetration system	spectral response	8~14μm
	temperature range	-40°C~200°C/-40°F~392°F
	temperature resolution	0.1°C/0.1°F
	temperature accuracy	±2.0°C (at -40°C~0°C), other range ±(1%+1.0)°C ±3.6°F (at -40°F~32°F), other range ±(1%+1.8)°F
	Repeatability	<1.0°C
	Measurement response time	<500ms
	Power supply	2×1.5V AAA batteries
	Dimension	140×39×24mm
	Weight	140g

- Can measure the surface and inside temperature of objects
- Low battery display
- Display backlight
- High and low alarm
- Automatic data hold (infrared system)
- Automatic power off (infrared system)
- Unit: °C/°F

STANDARD DELIVERY

Main unit	1 pc
Battery (AAA)	2 pcs

MULTI-CHANNEL TEMPERATURE LOGGERS



DATA OUTPUT

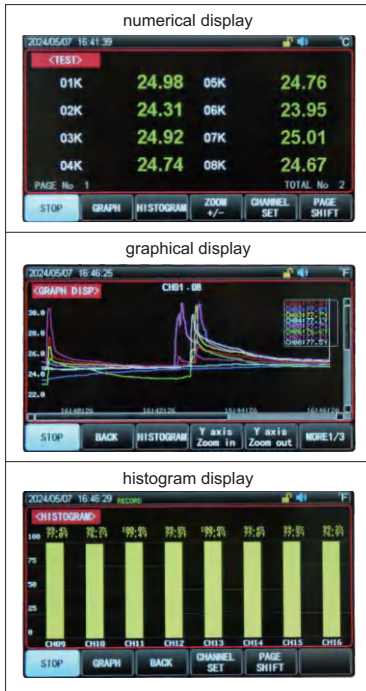

0350-MC16

K-type thermocouples (included)

- Suitable for home appliances, motors, electric heating appliances, thermostats, transformers, ovens, thermal protectors, power supplies, lighting, electric power, LED and other industries
- Unit: °C/°F/K
- Channels are compatible with thermocouple types K/N/E/J/T/R/S/B
- 4.3 inch true color LCD
- Direct numerical value reading, histogram and graphical display mode
- Upper and lower limit overrun alarm
- Independent correction per channel
- Automatic detection of open-circuit thermocouple
- Standard U disk interface, support real-time data storage
- Computer software is included

computer software (included): connect to PC software via RS232 cable or network cable to collect, display and save data as .csv format

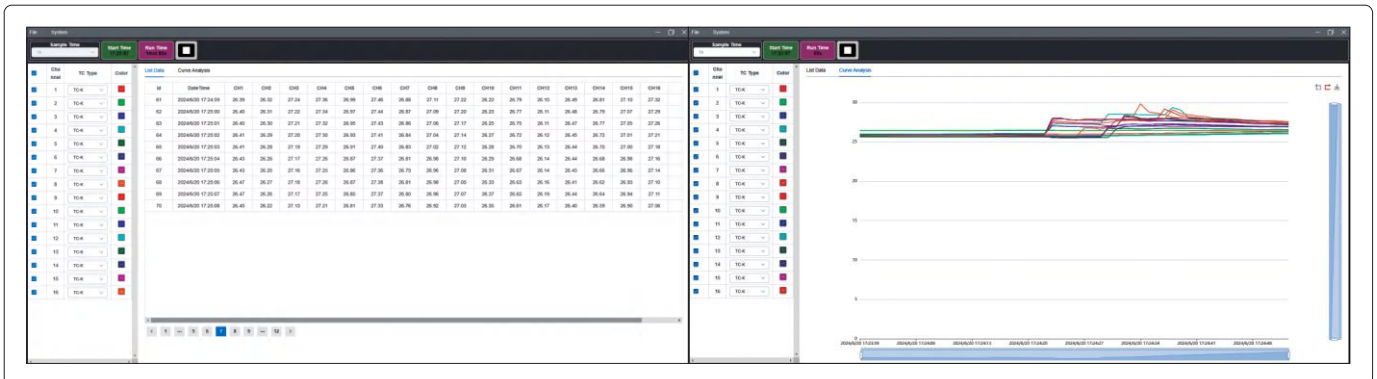

To be continued

Continued from previous page

SPECIFICATION

Code	0350-MC08	0350-MC16	0350-MC32	0350-MC48
Channel number	8	16	32	48
Weight	3.5kg	3.6kg	3.7kg	3.8kg
Thermocouple type	K/J/T/E/N/S/R/B			
Temperature range (electrical signal)	type K	-100°C~1350°C		
	type J	-100°C~1200°C		
	type T	-150°C~400°C		
	type E	-100°C~850°C		
	type N	-100°C~1300°C		
	type S	0°C~1750°C		
	type R	0°C~1750°C		
	type B	600°C~1800°C		
Temperature accuracy* (electrical signal)	type K	±1.2°C (at -100°C~0°C); ±0.8°C (at 0°C~1350°C)		
	type J	±1.0°C (at -100°C~0°C); ±0.7°C (at 0°C~1200°C)		
	type T	±1.0°C (at -150°C~0°C); ±0.8°C (at 0°C~400°C)		
	type E	±0.9°C (at -100°C~0°C); ±0.7°C (at 0°C~850°C)		
	type N	±1.5°C (at -100°C~0°C); ±0.9°C (at 0°C~1300°C)		
	type S	±4.5°C (at 0°C~100°C); ±3.0°C (at 100°C~300°C); ±2.2°C (at 300°C~1750°C)		
	type R	±4.5°C (at 0°C~100°C); ±3.0°C (at 100°C~300°C); ±2.2°C (at 300°C~1750°C)		
	type B	±5.5°C (at 600°C~800°C); ±3.8°C (at 800°C~1000°C); ±2.5°C (at 1000°C~1800°C)		
Temperature resolution	0.01°C			
Test speed	fast: 500ms, slow: 1s			
Cold junction	accuracy: 0.5°C			
Interface	communication interface: RS232C/LAN			
	storage interface: USB (only U disk)			
Remote control	baud rate supports up to 115200bps, compatible with SCPI protocol and ASCII transmission			
Power supply	AC: 100V~240V, 50/60Hz AC/DC adapter: 24V/1A (optional)			
Operation environment	temperature: 10°C~40°C humidity: 10%RH~90%RH (non-condensing)			
Storage environment	temperature: 0°C~50°C humidity: 10%RH~90%RH (non-condensing)			
Dimension	370×260×100mm			

* Accuracy is specified for main unit in the ambient temperature between 15°C and 35°C, the above specification does not include thermocouple probe error

STANDARD DELIVERY

Main unit	1 pc
K-type thermocouple (0350-K01)**	8/16/32/48 pcs
RS232 cable	1 pc
Network cable	1 pc
Software	1 pc

** Number of thermocouples corresponding to the number of channels

SPECIFICATION OF K-TYPE THERMOCOUPLE***

Code	Range	Accuracy	Length
0350-K01	-20°C~200°C	±1.5°C	2m

*** Other models, temperature range and length of thermocouples can be customized

OPTIONAL ACCESSORY

AC/DC adapter	0350-ADAPTER
---------------	--------------



DATA OUTPUT

BUILT-IN BLUETOOTH

THERMOCOUPLE THERMOMETER (FOUR CHANNELS) CODE 0323-CT47

- Unit: °C/°F/K
- Channels are compatible with 7 types of thermocouples K, J, T, E, R, S and N
- MAX/MIN/AVG/DIF mode
- 72000 data storage
- Offset value compensation
- Data hold function
- Display backlight
- Over range indicator
- Battery level display
- Automatic power off
- Built-in Bluetooth, mobile APP is included
- Computer software is included



SPECIFICATION

Thermocouple type	J/K/T/E/R/S/N
Temperature range (electrical signal)	K: -200°C~1372°C
	J: -210°C~1200°C
	T: -250°C~400°C
	E: -150°C~1000°C
	R: 0°C~1767°C
	S: 0°C~1767°C
Temperature accuracy* (electrical signal)	±(0.2%· t +0.5°C) (at -10°C~1767°C);
	±(0.2%· t +1.0°C) (at -200°C~-10°C);
Temperature resolution	0.1°C (<1000°C); 1°C (≥1000°C)
	±(0.1%· t +0.3°C)
Repeatability	±(0.1%· t +0.3°C)
Response time	500ms
Logging interval	1s~24h (adjustable)
Memory capacity	72000
Data transmission	TYPE-C USB, Bluetooth
Power frequency anti-interference	50/60Hz
Input protection	60Vmax
Drop proof	1m
Power supply	3×AAA alkaline batteries, working time>30h;
	TYPE-C USB (only be connected to a PC power)
Operation environment	temperature: -10°C~50°C
	humidity: <90%RH (non-condensing)
Storage environment	temperature: -20°C~60°C
	humidity: <90%RH (non-condensing)
Dimension	180×63×38mm
Weight	250g (including batteries)

*Accuracy is specified for ambient temperature between 18°C and 28°C, the above specification does not include thermocouple probe error

STANDARD DELIVERY

Main unit	1 pc
Battery (AAA)	3 pcs
USB cable	1 pc
K-type thermocouple (0323-K01)	4 pcs

OPTIONAL ACCESSORY

Tripod	0701-TR175
--------	------------

computer software (included): connect to PC software via USB cable to collect, display and stored data

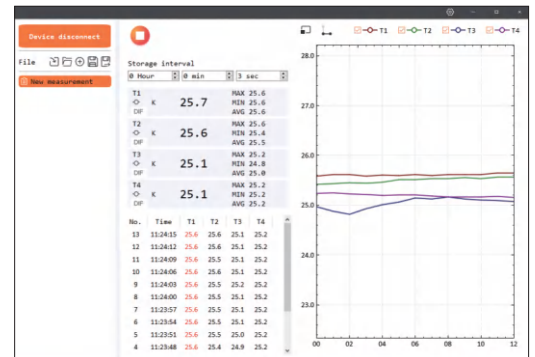

mobile APP (included): connect to mobile APP via Bluetooth to collect, display and stored data, and can export the data stored on the device

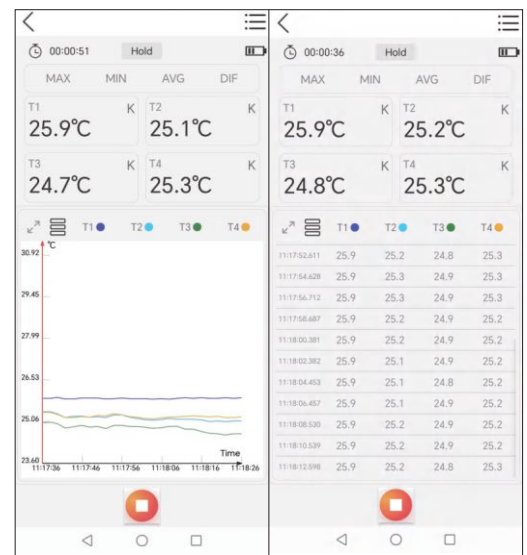

SPECIFICATION OF K-TYPE THERMOCOUPLE**

Code	Range	Accuracy	Length
0323-K01	-40°C~260°C	±0.75%	900mm

**Other models, temperature range and length of thermocouples can be customized

K-TYPE THERMOCOUPLE THERMOMETER (ECONOMIC TYPE) CODE 0320-K230

- Contact K-type thermocouple
- Unit: °C/°F
- Data hold function
- Low battery display
- Display backlight

SPECIFICATION

Temperature range	-50°C~200°C/-58°F~392°F
Temperature accuracy	±2.0°C/±3.6°F
Temperature resolution	0.1°C (at -50°C~199.9°C), 1°C (at -50°C~200°C) 0.1°F (at -58°F~199.9°F), 1°F (at -58°F~392°F)
Sampling rate	2.5 times/sec
Power supply	3×3V CR2450 batteries (for 300 hours working)
Operation voltage	6.8V~10V
Dimension	149×76×34mm
Weight	220g

STANDARD DELIVERY

Main unit	1 pc
Thermocouple (K-type)	1 pc
CR2450 battery	3 pcs



35

HIGH PRECISION DIGITAL THERMOMETERS



- Can measure the temperature of liquid, steam and gas
- Real time/MAX/MIN/AVG temperature display, real time resistance display
- Built-in gravity sensor, automatic horizontal or vertical screen display
- Display backlight
- Automatic power off
- Software is included: on-line monitoring, data storage

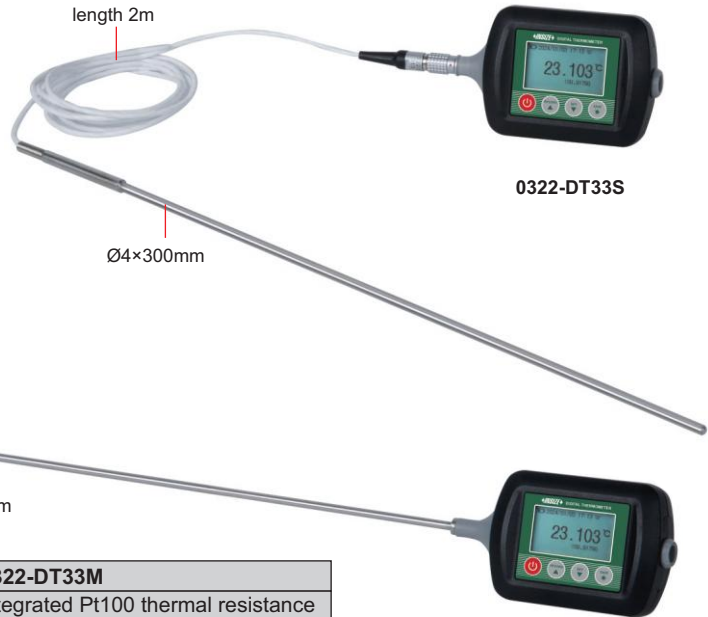

0322-DT33S

0322-DT33M

SPECIFICATION

Code	0322-DT33S	0322-DT33M
Sensor type	separated Pt100 thermal resistance	integrated Pt100 thermal resistance
Sensor dimension	Ø4×300mm	Ø4×500mm
Weight	147g	115g
Measuring range	-30°C~300°C/-22°F~572°F	
Resolution	0.1°C/0.01°C/0.001°C (adjustable) 0.1°F/0.01°F/0.001°F (adjustable)	
Accuracy	±0.5°C/±0.9°F	
Annual stability	±0.2°C/±0.36°F	
Response time	<60s	
Memory capacity	100,000	
Logging interval	1s~99s	
Power supply	rechargeable lithium battery, working time≥40h	
Operation environment	temperature: -10°C~50°C/14°F~122°F humidity: 0%RH~95%RH (non-condensing)	

STANDARD DELIVERY

Main unit	1 pc
Software	1 pc
Power adapter	1 pc



DIGITAL THERMOMETER (HIGH TEMPERATURE TYPE) CODE 0324-DT11

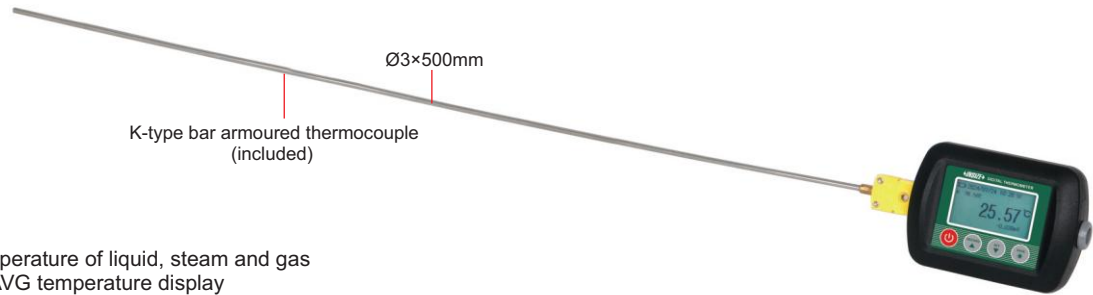

- Can measure the temperature of liquid, steam and gas
- Real time/MAX/MIN/AVG temperature display
- Built-in gravity sensor, automatic horizontal or vertical screen display
- Display backlight
- Automatic power off
- Software is included: on-line monitoring, data storage

35

SPECIFICATION OF MAIN UNIT

Thermocouple type	K/E/N/T/S
Temperature range	K: -200°C~1372°C
	E: -200°C~1000°C
	N: -200°C~1300°C
	T: -200°C~400°C
	S: -50°C~1768°C
Temperature accuracy *	K: ±0.8°C (at -200°C~0°C); ±0.6°C (at 0°C~1372°C)
	E: ±0.7°C (at -200°C~0°C); ±0.5°C (at 0°C~1000°C)
	N: ±0.8°C (at -200°C~0°C); ±0.6°C (at 0°C~1300°C)
	T: ±0.8°C (at -200°C~0°C); ±0.6°C (at 0°C~400°C)
	S: ±1.5°C (at -50°C~0°C); ±1.2°C (at 0°C~1768°C)
Temperature resolution	0.1°C/0.01°C (adjustable)
Annual stability	±8μV
Memory capacity	100,000
Logging interval	2s~99s
Power supply	rechargeable lithium battery, working time≥40h
Operation environment	temperature: -10°C~50°C humidity: 0%RH~95%RH (non-condensing)
Dimension	60×63×83mm
Weight	88g

* Accuracy is specified for ambient temperature between 18°C and 28°C, the above specification includes the error of the cold junction compensation and does not include the error of thermocouple sensor

K-type armoured thermocouple with extension wire (optional)

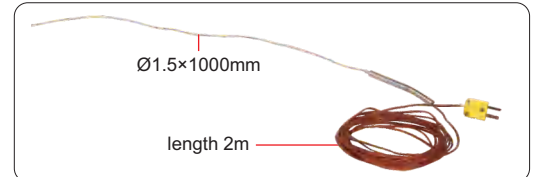

computer software (included): connect to PC software via data cable to collect, display and stored data

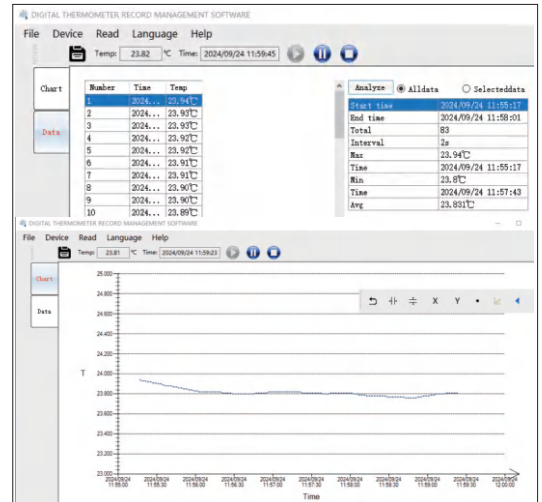

SPECIFICATION OF SENSOR **

Code	Product	Range ***	Accuracy	Dimension	Extension cord
0324-KB1	K-type bar armoured thermocouple	-40°C~1100°C	class 1: ±1.5°C or ±0.4%·t	Ø3×500mm	/
0324-KE2	K-type armoured thermocouple with extension wire	-40°C~1100°C	class 1: ±1.5°C or ±0.4%·t	Ø1.5×1000mm	2m

** Other models, temperature ranges and dimensions of thermocouples can be customized

*** Sensors are consumables and are recommended to be used within 1000°C, beyond that the service life will be reduced

STANDARD DELIVERY

Main unit	1 pc
K-type bar armoured thermocouple (0324-KB1)	1 pc
Software	1 pc
Power adapter	1 pc

OPTIONAL ACCESSORY

K-type armoured thermocouple with extension wire	0324-KE2
--	----------

DATA LOGGER FOR TEMPERATURE AND HUMIDITY (BUILT-IN SENSOR) CODE 0311-3070

IP54
WATERPROOF

DATA
OUTPUT



stand (included)

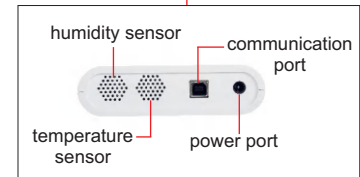

- Signal acquisition, display, storage, analysis function
- Low power consumption
- Built-in high-precision temperature and humidity sensor
- Software is included

SPECIFICATION

Temperature range	-30°C~70°C/-22°F~158°F
Temperature accuracy	±0.3°C (at 23°C±2°C), other range ±0.5°C ±0.6°F (at 73.4°F±3.6°F), other range ±0.9°F
Temperature resolution	0.1°C/0.2°F
Humidity range	0%RH~100%RH
Humidity accuracy	±3%RH (at 10%RH~85%RH), other range ±5%RH
Humidity resolution	0.1%RH
Memory capacity	10918
Alarm	function: alarm when over high or low limit method: display+buzz+backlight
Sampling interval	2s, 5s, 10s, 30s, 60s, 255s (adjustable)
Logging interval	2 seconds~24 hours (adjustable)
Start with delay	1~120 seconds (adjustable)
Start mode	start immediately/delay start/timing start
End mode	Full/FIFO/preset/timing end
Timing start/end	random start/end with format YYMMDD HHMMSS
Interface	USB
Time battery	CR2032
Power supply	3.6V lithium battery (ER14505) or 5~24V DC
Dimension	123×117×33mm
Weight	260g

STANDARD DELIVERY

Main unit	1 pc
Software and USB cable	1 pc
Power adapter	1 pc
Time battery	1 pc
Lithium battery	1 pc

software (included), record and download data to PC software via USB cable

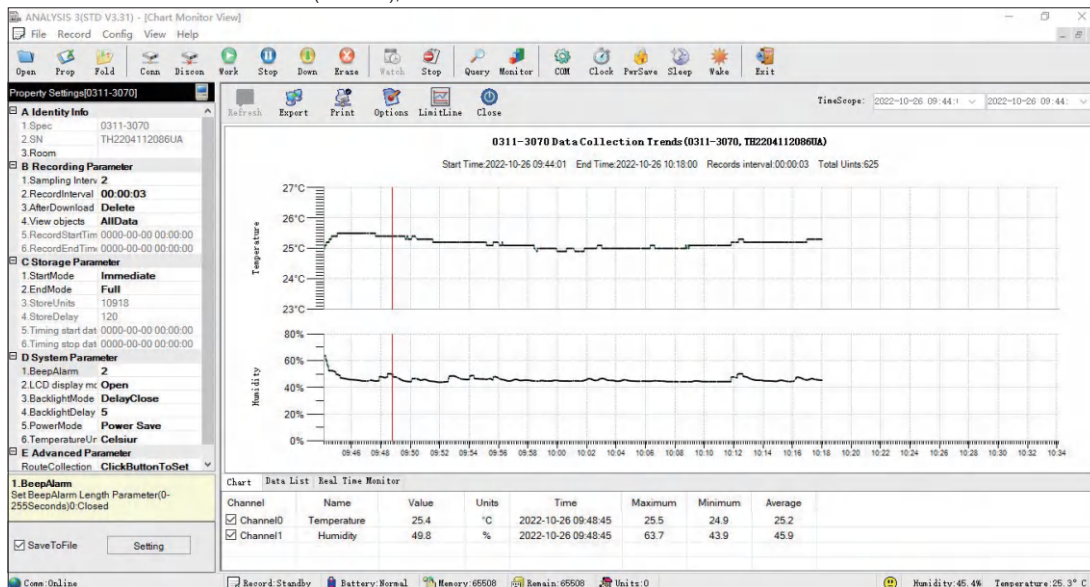



IP64
WATERPROOF

DATA
OUTPUT

MINI DATA LOGGER FOR TEMPERATURE AND HUMIDITY (BUILT-IN SENSOR) CODE 0317-TH37

- Built-in high-precision sensor
- 15000 memory for long-term logging
- Unit: °C/°F
- Display backlight
- Over range indicator
- Battery level display
- Computer software is included



STANDARD DELIVERY

Main unit	1 pc
USB cable	1 pc
Software	1 pc
4G USB flash disk	1 pc

35

SPECIFICATION

Temperature range	-30°C~70°C/-22°F~158°F
Temperature accuracy	±0.5°C/±0.9°F
Temperature resolution	0.1°C/0.2°F
Humidity range	0%RH~100%RH
Humidity accuracy	±3%RH (at 10%RH~85%RH, testing temperature: 23°C±2°C); ±5%RH (at 0%RH~10%RH and 85%RH~100%RH, testing temperature: 23°C±2°C)
Humidity resolution	0.1%RH
Memory size	15,000
Alarm	function: alarm when over high or low limit method: display+backlight
Sampling interval	2s, 5s, 10s, 30s, 60s, 255s
Logging interval	2s~24h (adjustable)
Start with delay time	1s~120s (adjustable)
Start mode	key operation/start immediately/time-lapse start/timing start
End mode	key operation/Full/FIFO/presetting units/timing end
Interface	Mini USB
Power supply	3.6V rechargeable lithium battery, working time: 1 year (with sample rate of 60s)
Storage temperature	-50°C~90°C
Dimension	86.2×64.2×25.4mm
Weight	81g

software (included), record and download data to PC software via USB cable

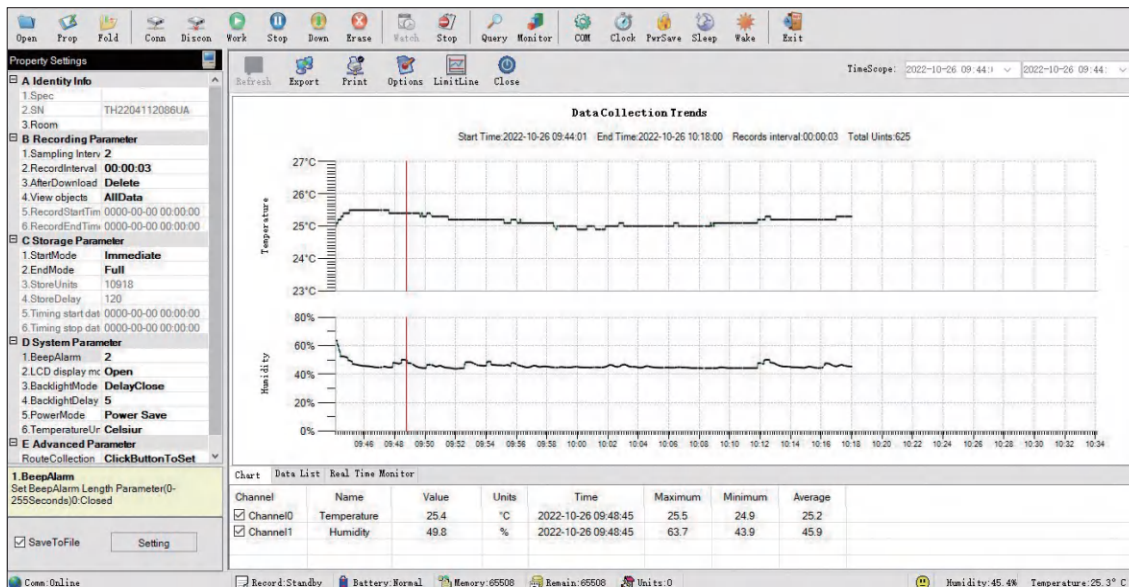

MINI TEMPERATURE AND HUMIDITY METER CODE 0319-TH60



- 3.5" LCD screen
- Temperature/humidity/time/comfort display
- Highest/lowest temperature and humidity memory function
- Unit: °C/°F



35

SPECIFICATION

Temperature range	0°C~55°C/32°F~131°F
Temperature resolution	0.1°C/0.1°F
Temperature accuracy	±0.5°C/±0.9°F
Humidity range	0%RH~99%RH (non-condensing)
Humidity resolution	1%RH
Humidity accuracy	±5%RH (at 10%RH~90%RH), other range ±7%RH
Power supply	2×3V CR2032 batteries
Dimension	88×70×12mm
Weight	62g

STANDARD DELIVERY

Main unit	1 pc
Battery (CR2032)	2 pcs

THERMOHYGROMETER (BASIC TYPE) CODE 0316-TH62

- Temperature/humidity/time display
- High and low alarm
- Low battery display
- Display backlight
- Environment comfort display



SPECIFICATION

Temperature range	-20°C~60°C
Temperature accuracy	±0.5°C (at 26°C~42°C), other range ±1.0°C
Temperature resolution	0.1°C
Humidity range	10%RH~99%RH (non-condensing)
Humidity accuracy	±5%RH (45%RH~79%RH), other range ±7%RH
Humidity resolution	0.1%RH
Sampling interval	3s
Power supply	2×AAA batteries
Dimension	117×94×23mm
Weight	149g

STANDARD DELIVERY

Main unit	1 pc
Battery (AAA)	2 pcs

IP50
DUSTPROOF

DIGITAL THERMOHYGROMETER (ADVANCED TYPE) CODE 9362-TH27

- Measure humidity, ambient temperature and dew-point temperature
- Max/Min/Average mode
- Alarm function
- IP50 protection grade

SPECIFICATION

Sensor model	NTC thermistor/humidity capacitance/digital sensor
Temperature range	-20°C~70°C/-4°F~158°F
Temperature accuracy	±0.5°C/±0.9°F
Temperature resolution	0.1°C/0.2°F (minimum adjustable unit is 0.2°F in setting mode)
Humidity range	0~100%RH
Humidity accuracy	±5%RH
Humidity resolution	0.1%RH
Sampling interval	5s
Power supply	1.5V AAA battery
Dimension	95×107×18mm
Weight	105g



STANDARD DELIVERY

Main unit	1 pc
Battery (AAA)	1 pc

35

THERMOHYGROMETER (EXTERNAL SENSOR) CODE 0313-TH48

- External sensor, 3m cable
- Time/temperature/humidity display
- Temperature and humidity upper and lower limit alarm function
- Unit: °C/°F
- Low battery alarm



SPECIFICATION

Temperature range	-40°C~80°C/-40°F~176°F
Temperature accuracy	±0.5°C (at -20°C~60°C), ±1.0°C (at 60°C~80°C), ±2°C (at -40°C~-20°C), ±2°F (at -20°F~176°F), ±3°F (at -40°F~-20°F)
Temperature resolution	0.1°C (at -20°C~80°C), other range 1°C 0.1°F (at -20°F~100°F), other range 1°F
Humidity range	0%RH~99.9%RH
Humidity accuracy	±5%RH (at 10°C~60°C), other range ±7% ±5%RH (at 50°F~140°F), other range ±7%
Humidity resolution	0.1%RH
Sensitivity attenuation value	temperature: <0.1°C/year (<0.2°F/year) humidity: <1%RH/year
Sampling interval	5 seconds
Power supply	built-in rechargeable lithium battery (USB 5V charging) working time at least one month
Dimension	88×88×21mm
Weight	174g

STANDARD DELIVERY

Main unit	1 pc
USB charging cable	1 pc

THERMOHYGROMETER CODE 0310-H26



- Measure humidity, ambient temperature, dew point temperature and wet bulb temperature
- Min/Max, data hold function
- Bluetooth 4.0
- Auto power off
- Supplied with APP for Apple and Android

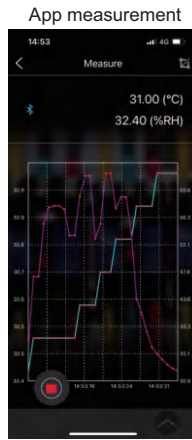

App record

No.	Data Value (°C)	Data Value (%RH)
1	30.90	41.40
2	30.90	38.50
3	30.90	36.10
4	31.00	35.10
5	31.00	34.20
6	31.00	33.40
7	31.00	32.80
8	31.00	32.40
9	31.00	32.10
10	31.00	32.00
11	31.00	31.70
12	31.00	31.40



SPECIFICATION

Function	Measuring range	Resolution	Accuracy
Ambient temperature	0°C~50°C 32°F~122°F	0.1°C/0.1°F	±1.0°C/±1.8°F
Wet bulb temperature	0°C~50°C 32°F~122°F		
Dew point temperature	0°C~50°C 32°F~122°F		
Humidity	0%RH~80%RH	0.1%RH	±5.0%RH
Auto power off	30 minutes		
Data port	Bluetooth 4.0		
Power supply	9V battery		
Dimension	204×54×36mm		
Weight	172g		

STANDARD DELIVERY

Main unit	1 pc
Battery	1 pc

OPTIONAL ACCESSORY

Tripod	0701-TR175
--------	------------

THERMOHYGROMETER CODE 0315-HT164

BUILT-IN
BLUETOOTH

- Real-time value/maximum/minimum display
- Unit: °C/°F
- Display backlight
- Automatic power off
- Low battery display
- Over range indicator
- Built-in bluetooth, mobile APP is included

SPECIFICATION

Temperature range	-10°C~60°C
Temperature accuracy	±1.0°C
Temperature resolution	0.1°C
Humidity range	0%RH~99.9%RH
Humidity accuracy	±5.0%RH
Humidity resolution	0.1%RH
Sampling interval	1s
Power supply	3×AAA batteries, working time≥12h
Operation environment	temperature: 0°C~40°C humidity: <90%RH (non-condensing)
Storage environment	temperature: -20°C~60°C humidity: <75%RH (non-condensing)
Dimension	137×55×28mm
Weight	102g

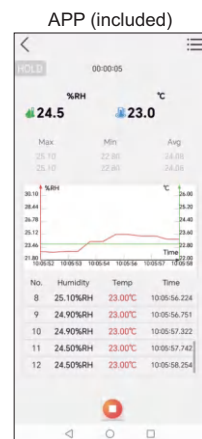

STANDARD DELIVERY

Main unit	1 pc
Battery (AAA)	3 pcs

OPTIONAL ACCESSORY

Tripod	0701-TR175
--------	------------

- Environment comfort display: COMFORT, WET, DRY
- Time/temperature/humidity display
- Highest/lowest temperature and humidity memory function
- Alarm clock function
- Unit: °C, °F

TEMPERATURE AND HUMIDITY METER (ECONOMIC TYPE) CODE 0312-TH50

SPECIFICATION

Temperature range	0°C~50°C/32°F~122°F
Temperature accuracy	±1.0°C (at 5°C~40°C), other range ±1.5°C ±1.8°F (at 41°F~104°F), other range ±2.7°F
Temperature resolution	0.1°C/0.1°F
Humidity range	10%RH~90%RH
Humidity accuracy	±5%RH (at 40%RH~80%RH), other range ±8%RH
Humidity resolution	1%RH
Power supply	1×AAA 1.5V battery
Dimension	108×60×15mm
Weight	74g



STANDARD DELIVERY

Main unit	1 pc
Battery	1 pc

LARGE SCREEN TEMPERATURE AND HUMIDITY METERS

0314-H533A

0314-H533B

- High definition LED large screen display: temperature, humidity, time
- Exceeding limit alarm: buzzer alarm, digit/light flash alarm
- Installation method: wall mounted or ring type

STANDARD DELIVERY

Main unit (including sensor)	1 pc
------------------------------	------

SPECIFICATION

Code	0314-H323A	0314-H323B	0314-H423A	0314-H423B	0314-H533A	0314-H533B	0314-H643A	0314-H643B
Dimension	300×200×36mm		400×265×36mm		500×330×36mm		600×400×36mm	
Sensor type	integrated	separated	integrated	separated	integrated	separated	integrated	separated
Power consumption	5W		5W		9W		10W	
Weight	1.3kg		2kg		3kg		4kg	
Sensor	integrated: plastic probe case (not dustproof, not waterproof) separated: metal probe case (dustproof, waterproof), cable length 1m (can be customized, within 20m)							
Temperature range	integrated: -20°C~60°C; separated: -40°C~85°C							
Temperature resolution	integrated: 0.1°C (at 0°C~60°C), other range 1°C separated: 0.1°C (at 0°C~85°C), other range 1°C							
Temperature accuracy	integrated: ±0.5°C (at 0°C~60°C), other range ±2°C separated: ±0.5°C (at 0°C~85°C), other range ±2°C							
Humidity range	5%RH~95%RH							
Humidity resolution	0.1%RH							
Humidity accuracy	±3%RH (@25°C)							
Long-term stability	temperature≤0.1°C/year; humidity≤1%RH/year							
Repeatability	temperature≤0.1°C; humidity≤0.5%RH							
Sampling speed	1s							
Response time	3 minutes to reach 90% of the final value							
Time accuracy	±15s/month (@25°C±2°C)							
Power supply	AC100~240V (50/60Hz)							
Power cable length	1.8m							
Operation condition	temperature: -20°C~60°C; humidity: 5%~95% (non-condensing)							

TEMPERATURE AND HUMIDITY DATA LOGGER CODE THL-A01



35

- Suitable for testing the temperature field, humidity field, uniformity and volatility of various temperature (humidity) environment experimental equipment, industrial furnaces and verification furnaces
- 24 channels can be independently configured as thermocouple, platinum resistance, humidity sensor and analog input mode
- Each channel provides an accuracy advantage over 0.15°C thermocouple for cold-end compensation
- Support voltage, resistance, temperature, humidity and other data formats display, storage and output
- Support Wireless Network, RS232 communication mode: Wireless Network can remotely browse real-time data and download stored data, RS232 communication protocol based on RSCII code for encoding and reading data
- Built-in 8G large capacity memory, data can be exported via USB port

SPECIFICATION OF TEMPERATURE AND HUMIDITY DATA LOGGER

	Type (electrical signal)	Range	Resolution	Accuracy
Temperature	PT100	-200 ~950°C	0.001°C	0.05°C at 0°C 0.08°C at 300°C 0.12°C at 600°C
	K	-200°C~1300°C	0.01°C	0.5°C
	J	-200°C~900°C		0.5°C
	T	-200°C~400°C		0.5°C
	E	-200°C~1000°C		0.5°C
	N	-200°C~1300°C		0.5°C
	B	250°C~1820°C		0.8°C at 1000°C
	R	0°C~1768°C		0.7°C at 1000°C
	S	0°C~1768°C		0.9°C at 1000°C
Humidity	-	0%RH~100%RH	0.01%RH	0.1%RH
Voltage	range: 100mV	-10mV~100mV	0.1μV	0.01% of reading+0.008% of full scall
	range: 1V	0V~1V	0.1mV	0.01% of reading+0.008% of full scall
Resistance	range: 400Ω	0Ω~400Ω	0.1mΩ	0.004% of reading+0.004% of full scall
Sampling mode	24-channel synchronous sampling			
Sampling speed	0.2s/24 channel			
Memory	8G			
Output	USB, wireless, RS232			
Operation environment	temperature: 5°C~35°C			
	humidity: 0%RH~85%RH (non-condensing)			
Storage environment	temperature: 5°C~35°C			
	humidity: 0%RH~85%RH (non-condensing)			
Power supply	power adapter			
Dimension	250×180×75mm			
Weight	1.7kg			

To be continued

Continued from previous page



K-type thermocouple (optional)



humidity sensor (optional)



platinum resistance PT100 (optional)

STANDARD DELIVERY

Main unit	1 pc
Power adapter	1 pc
16G USB flash disk	1 pc

OPTIONAL ACCESSORY

Platinum resistance PT100	THL-A01-PT100
K-type thermocouple	THL-A01-K
Humidity sensor	THL-A01-H

SPECIFICATION OF SENSOR (OPTIONAL)

Product	Code	Range	Accuracy
platinum resistance PT100	THL-A01-PT100	-80~300°C	class A: $\pm(0.150^{\circ}\text{C}+0.002 \cdot t)$
K-type thermocouple	THL-A01-K	300~1000°C	class 1: $\pm 1.5^{\circ}\text{C}$ (at 300°C~375°C), $\pm 0.004 \cdot t$ (at 375°C~1000°C)
humidity sensor	THL-A01-H	0%RH~100%RH	0.8%RH (at 23°C)



**PORTABLE MEDIUM TEMPERATURE DRY BLOCK CALIBRATOR
CODE DBC-M660**

- Used for temperature calibration in industrial or laboratory
- Unit: °C, °F
- Language: English, Chinese
- Overheat protection
- Multi-point temperature correction function
- Automatic tuning of temperature control parameters
- Segmented PID control, one-button heating, full-automatic temperature control



SPECIFICATION

Temperature range	50°C~660°C	
Horizontal temperature field	≤0.2°C	
Vertical temperature field	within 40mm from the bottom of the well	≤0.5°C (at 50°C~300°C)
		≤1.0°C (at 300°C~660°C)
Temperature fluctuation	±0.15°C	
Temperature resolution	0.01°C	
Control method	touch screen	
Soaking block	insertion aperture: Ø4.5mm, Ø6.5mm, Ø8mm, Ø10mm (can be customized)	
Well depth	170mm	
Power	600W	
Power supply	220V/50Hz	
Dimension	285×170×335mm	
Weight	9.4kg	

real-time display of curve

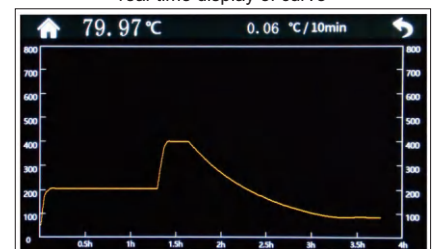

STANDARD DELIVERY

Main unit	1 pc
Soaking block	1 pc

DIFFERENTIAL PRESSURE MANOMETER CODE 0140-DP05

DATA
OUTPUT

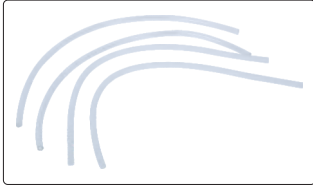

soft tubes (included)

35

- Offset and differential measurement
- Record maximum/minimum/average value with relative timestamp
- Built-in USB interface for data transmission
- Unit: kPa, psi, inH₂O, bar, mbar, inHg, mmHg, oz/in², ftH₂O, cmH₂O, kg/cm²
- Zero adjust
- Data hold
- Display with backlight
- Low battery indication
- Automatic power off
- Safety rating: CAT III 600V

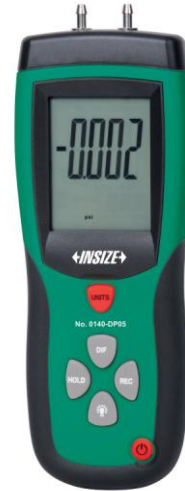

SPECIFICATION

Measurement range	-34.47kPa~34.47kPa
Maximum pressure	137.9kPa
Unit	kPa
Resolution	0.01
Accuracy	±0.3%FSO (25°C)
Repeatability	±0.2% (Max. ±0.5%FSO)
Linearity/hysteresis	±0.29%FSO
Response time	0.5s typical
Operation temperature	0°C~50°C
Power supply	1×9V 6F22 battery or AC/DC adapter
Dimension	165×90×40mm
Weight	350g

STANDARD DELIVERY

Main unit	1 pc
AC/DC adapter	1 pc
9V battery	1 pc
Software and USB cable	1 pc
Soft tubes	4 pcs

software (included), connect to PC via USB cable

OPTIONAL ACCESSORY

Tripod	0701-TR175
--------	------------

export data

display realtime value and curve

export data to Excel

ANEMOMETER CODE 0110-1125



App measurement

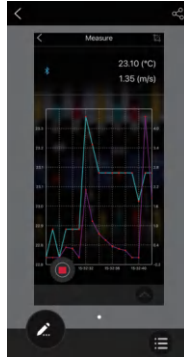

App record

No.	Data Value (°C)	Data Value (m/s)
1	23.10	0.22
2	23.10	0.00
3	23.00	0.00
4	23.10	4.39
5	23.10	1.85
6	23.00	1.06
7	23.00	0.72
8	23.00	0.44
...



- Measure air velocity and temperature
- Min/Max, data hold function
- Bluetooth 4.0
- Auto power off
- Supplied with APP for Apple and Android

SPECIFICATION

	Unit	Measuring range	Resolution	Accuracy
Air velocity	m/s	1.1~25.0	0.01	±(3%+0.3)
	km/h	4~90	0.1	±(3%+1)
	ft/min	220~4920	1	±(3%+40)
	MPH	2.5~56.0	0.1	±(3%+0.4)
	knots	2.2~48.0	0.1	
Air temperature	°C	0~50	0.1	±2
	°F	32~122	0.1	±4
Sensors	air velocity sensor, NTC-type precision thermistor			
Sampling time	0.5s			
Operation altitude	max 2000m			
Operation environment	0~50°C, 0~80%RH			
Storage environment	-10~60°C, 0~80%RH			
Auto power off	10 minutes			
Data port	bluetooth 4.0			
Power supply	9V battery			
Dimension	213×54×36mm			
Weight	172g			

STANDARD DELIVERY

Main unit	1 pc
Battery	1 pc

OPTIONAL ACCESSORY

Tripod	0701-TR175
--------	------------

HOT WIRE ANEMOMETER CODE 0111-HW30



sensor



35

- Measure with platinum resistance sensor, high accuracy and stability
- Retractable aluminum alloy rod with slim probe, split design for convenient operation
- Maximum/minimum/average mode
- Over-range indication
- Display with backlight
- Low battery indication
- Automatic power off

SPECIFICATION

Function	Range	Accuracy	Resolution
Wind velocity	0~30m/s	$\pm(4\%+0.1\text{m/s})$	specified environment temperature: 15°C~30°C
	0~108km/h	$\pm(4\%+0.4\text{km/h})$	
	0~58.3kn	$\pm(4\%+0.2\text{kn})$	
	0~5906fpm	$\pm(4\%+20\text{fpm})$	
	0~67.1mph	$\pm(4\%+0.3\text{mph})$	
	0~11bft	$\pm 1\text{bft}$	
Wind temperature	0°C~40°C	$\pm 0.5^\circ\text{C}$	specified wind velocity: $\geq 1.5\text{m/s}$
	-20°C~0°C, 40°C~70°C	$\pm 0.8^\circ\text{C}$	
Wind flow	maximum range: 9999×10^2 unit: m^3/min , CFM, L/s area setting: area, circle (set radius), rectangle (set length and width)		
Retractable rod length	1.2m		
Storage capacity	99 groups		
Operation environment	temperature: 0°C~40°C, humidity: $\leq 80\%RH$ (no condensation)		
Storage environment	temperature: -20°C~60°C, humidity: $\leq 80\%RH$ (no condensation)		
Power supply	3×AAA battery		
Dimension	181×63×40mm		
Weight	350g		

STANDARD DELIVERY

Main unit	1 pc
Battery (AAA)	3 pcs

OPTIONAL ACCESSORY

Tripod	0701-TR175
--------	------------



SOUND LEVEL METER (ADVANCED TYPE) CODE 0011-FA25

software (included), monitor and collect data to PC software via USB cable,
data can sent to Excel

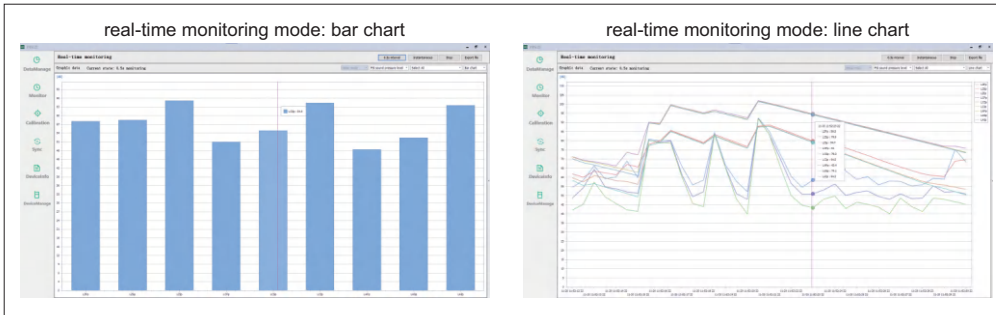

- Integral function: 1s~24h (adjustable)
- Wide frequency range, large dynamic range, low background noise
- Parallel time weight and frequency weight
- Single range without shifting
- Software is included: on-line monitoring, data storage

SPECIFICATION

Accuracy	IEC 61672-1:2013 class 2
Microphone	1/2 inch prepolarized condenser microphone
Measuring range	25dB (A)~141dB (A); 35dB (C)~141dB (C); 50dB (Z)~141dB (Z) other frequency linear ranges: 31.5Hz: 26dB (A)~101dB (A); 12.5kHz: 25dB (A)~136dB (A)
Frequency	20Hz~12.5kHz
Self-generated electrical noise	<17dB (A), <23dB (C), <33dB (Z)
Frequency weighting	parallel A, C, Z weightings
Time weighting	parallel F (Fast), S (Slow), I (Impulse) weightings
Measuring function	Lp, Leq,t, Leq,T, Lmax, Lmin, Lpeak, SEL
Integral time	1s-24h (adjustable)
Start mode	button/clock/limit/interval
Power setting	power on or off regularly
Data storage	4MB FLash RAM 4 sets of parameter templates, 128 measurement point names; 64 calibration records
Language	Chinese, English, Portuguese
Power	<80mA/5V
Power supply	4×AAA batteries (for 10 hours working) AC/DC adapter: 5V/2A
Operation condition	temperature: -10°C~50°C humidity: 25%RH~90%RH, non-condensing pressure: 65kPa~108kPa
Dimension	230×69×26mm
Weight	180g

STANDARD DELIVERY

Main unit	1 pc
Software	1 pc
Windscreen	1 pc
Battery (AAA)	4 pcs
AC/DC adapter	1 pc

OPTIONAL ACCESSORY

Tripod	0701-TR175
--------	------------

DIGITAL SOUND LEVEL METER CODE 9351-130

DATA
OUTPUT

- Automatically select best range: 30~80dB, 40~90dB, 50~100dB, 60~110dB, 70~120dB, 80~130dB
- Over range indicator
- Real time, average, maximum modes
- Memory 16000 measurement values
- AC signal output: 0.707 Vrms at FS, impedance approx. 600Ω
DC signal output: 10mV/dB, impedance approx.100Ω
- Automatic power off



software flash disk
(included)

SPECIFICATION

Measuring range	30~130dB
Accuracy	±2dB
Resolution	0.1dB
Sampling time	0.5s for digital, 0.05s for analogue
Response time	fast: 125ms, slow: 1s
Frequency	30Hz~8kHz
Frequency weighting	A/C
Microphone	electret condenser type
Output	RS232, AC/DC
Power supply	6×AAA batteries
Dimension	265×80×69mm
Weight	317g

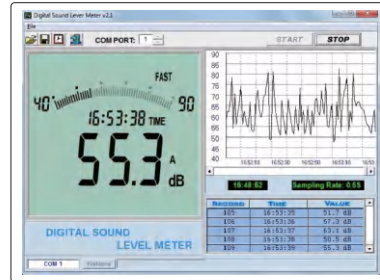

software (included), display measurement values and graph, save and output data



STANDARD DELIVERY

Main unit	1 pc
Software and RS232 cable	1 pc
Output connector	1 pc
Battery (AAA)	6 pcs

OPTIONAL ACCESSORY

Tripod	0701-TR175
--------	------------

SOUND LEVEL METER (BASIC TYPE) CODE 0010-A35

- Auto range selection
- Over range indication
- Display backlight
- Min/Max, data hold function
- Bluetooth 4.0
- Auto power off
- Supplied with APP for Apple and Android

App measurement

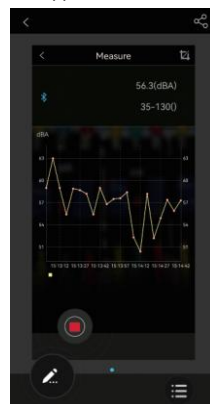

App record

2022-10-27 15-10-45

Data Value(dBA)
 Rec Time: 10/27/2022 15:10:49-15:10:57
 Data num: 9 Sample Rate:1s
 Max: 66.4 dBA 10/27/2022 15:10:55
 Min: 55.6 dBA 10/27/2022 15:10:51
 Avg: 60.5222 dBA

No.	Data Value (dBA)	Data Value	DataTime
1	58.3	50-100	15:10:49
2	61.2	50-100	15:10:50
3	55.6	50-100	15:10:51
4	59.1	50-100	15:10:52
5	56.7	50-100	15:10:53
6	61.7	50-100	15:10:54
7	66.4	50-100	15:10:55
8	64.8	50-100	15:10:56
9	60.9	50-100	15:10:57

SPECIFICATION

Frequency	31.5Hz~8kHz
Measuring range	35dB~130dB
Accuracy	±3.0dB (ref 94dB@1kHz)
Resolution	0.1dB
Frequency weighting	A and C
Display update	2 times/sec
Microphone	1/2 inch electret condenser microphone
Power supply	9V battery
Operation temperature and humidity	0°C~40°C/32°F~104°F, 10%RH~90%RH
Dimension	185×54×36mm
Weight	184g



STANDARD DELIVERY

Main unit	1 pc
Battery	1 pc
Windscreen	1 pc

OPTIONAL ACCESSORY

Tripod	0701-TR175
--------	------------

DIGITAL SOUND LEVEL METER (ADVANCED TYPE) CODE 9353-413

- Automatic range conversion
- Over range indicator
- Maximum mode
- Data hold
- AC signal output: 0.707Vrms, impedance approx.100Ω
- DC signal output: 20mV/dB, impedance approx.1kΩ

SPECIFICATION

Measuring range	40dB~130dB (ref.20μPa)
Frequency	20Hz~12.5kHz
Resolution	0.1dB
Accuracy	IEC 61672-1:2013 class 2
Frequency weighting	A weighting
Response time	fast (125ms), slow (1s)
Microphone	pre polarization condenser microphone
Refercner direction	axial direction of condenser microphone
Power supply	4×1.5V AAA batteries
Dimension	210×68×27mm
Weight	240g



STANDARD DELIVERY

Main unit	1 pc
Battery (AAA)	4 pcs
Precision screwdriver	1 pc

OPTIONAL ACCESSORY

Tripod	0701-TR175
--------	------------

SOUND CALIBRATOR CODE 0012-SC20

- According to IEC 60942:2017
- Calibrate and test the sound pressure sensitivity of class 2 sound level meter, check and adjust the overall sensitivity of acoustic measuring device or system
- Single frequency, multiple sound pressure levels: 1000Hz, 94dB/104dB/114dB/124dB



coupling cavity
1/2" microphone adapter (included)

SPECIFICATION

Accuracy	IEC 60942:2017 class 2
Nominal sound pressure level	94dB, 104dB, 114dB, 124dB
Acceptance limit for sound pressure level	0.4dB
Nominal frequency	1000Hz
Acceptance limit for frequency	1.7%
Total distortion+noise	3.0%
Warm-up time	<15s
Operation environment	temperature: -10°C~50°C humidity: 25%RH~90%RH pressure: 65kPa~108kPa
Power supply	rechargeable lithium battery, working time≥5h
Dimension	58×58×58mm
Weight	170g

STANDARD DELIVERY

Main unit (including 1/2" microphone adapter)	1 pc
1/4" microphone adapter	1 pc
Wrench	1 pc
Power adapter	1 pc



1/4" microphone adapter (included)



wrench (included)

LIGHT METER (ECONOMIC TYPE) CODE 0131-A120



35



- Photosensor can rotate 90° clockwise and 180° counterclockwise
- Build-in calibration filters ensure the accuracy when working in different colors
- Data hold function
- Lux/FC unit switch
- Low battery alarm

SPECIFICATION

Measuring range	0.1~199.9Lux	1~1999Lux	10~19990Lux	100~199900Lux
Resolution	0.1Lux	1Lux	10Lux	100Lux
Measuring range	0.01~19.99FC	0.1~199.9FC	1~1999FC	10~19990FC
Resolution	0.01FC	0.1FC	1FC	10FC
Accuracy	$\pm(4\%+10d)$, range<20000Lux/2000FC $\pm(5\%+10d)$, range \geq 20000Lux/2000FC (d is resolution, calibrated with standard incandescent lamp at color temperature 2856K)			
Repeatability	$\pm 2\%$			
Sampling time	0.5s			
Operation environment	0~40°C, 0~70%RH			
Storage environment	-10~50°C, 0~80%RH			
Power supply	9V battery			
Dimension	185×68×38mm			
Weight	130g			

STANDARD DELIVERY

Main unit	1 pc
Battery	1 pc

OPTIONAL ACCESSORY

Tripod	0701-TR175
--------	------------



LIGHT METER (ECONOMIC TYPE) CODE 0130-L110

- Suitable for measuring illuminance in various occasions
- Data hold function
- Fast switching of measuring range, easy to operate

SPECIFICATION

Measuring range	1~1999Lux	10~19990Lux	100~100000Lux
Resolution	1Lux	10Lux	100Lux
Accuracy	$\pm(4\%+10d)$, range<10000Lux $\pm(5\%+10d)$, range \geq 10000Lux (d is resolution, calibrated with standard incandescent lamp at color temperature 2856K)		
Repeatability	$\pm 2\%$		
Sampling time	0.5s		
Operation environment	0~40°C, 0~70%RH		
Storage environment	-10~50°C, 0~80%RH		
Power supply	9V battery		
Photodetector dimension	105×58×28mm		
Main unit dimension	130×72×30mm		
Weight	170g		



STANDARD DELIVERY

Main unit	1 pc
Battery	1 pc



UV LIGHT METER CODE 0132-UV199

- Self-recognize probes
- Real-time value, maximum value, minimum value, average value, time, energy value are displayed at the same time



PROBE SPECIFICATION

Probe code	0132-UVA1 (included)	0132-UVC0 (optional)	0132-UVCWP1 (optional)
Application	general purpose low power UVA intensity and energy measurement	intensity and energy measurement of 254nm UV sterilization mercury lamp	intensity and energy measurement of 254nm UV sterilization mercury lamp
Spectral response	$\lambda_p=365\text{nm}$ 315nm-400nm	$\lambda_p=254\text{nm}$ 230nm-280nm	
Power measuring range	0~200000 $\mu\text{W}/\text{cm}^2$		
Resolution	0.1 $\mu\text{W}/\text{cm}^2$		
Energy measuring range	0-9999999 $\mu\text{J}/\text{cm}^2$		
Measuring accuracy	$\pm 10\%$		
Record time	0-99999s		
Sampling speed	6 times/second		
Measuring unit	$\mu\text{W}/\text{cm}^2$ (default), mW/cm^2 , W/m^2		
Test hole diameter	$\varnothing 10\text{mm}$		
Probe size	39×32×15mm	$\varnothing 39 \times 15\text{mm}$	$\varnothing 50 \times 20\text{mm}$
Waterproof depth	—	—	1m

To be continued

Continued from previous page

Probe code	0132-UVLED0 (optional)	0132-UVB0 (optional)	0132-UVA0 (optional)
Application	measurement of 260nm-285nm UV LED sterilization lamp	general purpose UVB intensity and energy measurement	intensity and energy measurement of light source of high pressure mercury lamp in UV curing industry
Spectral response	280nm-315nm *	$\lambda_p=310\text{nm}^{**}$ 280nm-315nm	$\lambda_p=365\text{nm}$ 315nm-400nm
Power measuring range	0~200000 $\mu\text{W}/\text{cm}^2$		0~2000 mW/cm^2
Resolution	0.1 $\mu\text{W}/\text{cm}^2$		0.1 mW/cm^2
Energy measuring range	0-9999999 $\mu\text{J}/\text{cm}^2$		
Measuring accuracy	$\pm 10\%$		
Record time	0-99999s		
Sampling speed	6 times/second		2048 times/second
Measuring unit	$\mu\text{W}/\text{cm}^2$ (default), mW/cm^2 , W/m^2		mW/cm^2 (default), W/m^2
Test hole diameter	$\varnothing 10\text{mm}$		
Probe size	$\varnothing 39 \times 15\text{mm}$		$39 \times 32 \times 15\text{mm}$

*Wide spectral range, avoid using in strong light

**Suitable for measuring UVB light source with wavelength 297nm, 308nm, and 313nm

Probe code	0132-UVALED0 (optional)	0132-UVALED1 (optional)	0132-UVALED3 (optional)
Application	intensity and energy measurement of area light source of UV LED in UV curing industry	intensity and energy measurement of point light source of UV LED in UV curing industry	general purpose UVA+UVV LED intensity and energy measurement, low power measuring range
Spectral response	calibrated with 395nm UV LED 340nm-420nm		
Power measuring range	0~20000 mW/cm^2		0~200000 $\mu\text{W}/\text{cm}^2$
Resolution	1 mW/cm^2		0.1 $\mu\text{W}/\text{cm}^2$
Energy measuring range	0-9999999 $\mu\text{J}/\text{cm}^2$		
Measuring accuracy	$\pm 10\%$		
Record time	0-99999s		
Sampling speed	2048 times/second		6 times/second
Measuring unit	mW/cm^2 (default), W/cm^2 , W/m^2		$\mu\text{W}/\text{cm}^2$ (default), mW/cm^2 , W/m^2
Test hole diameter	$\varnothing 10\text{mm}$	$\varnothing 1\text{mm}$	$\varnothing 10\text{mm}$
Probe size	$39 \times 32 \times 15\text{mm}$		

MAIN UNIT SPECIFICATION

Display	240×160 LCD
Power supply	4 AAA alkaline batteries
Dimension	148×76×26mm
Weight	194g

STANDARD DELIVERY

Main unit	1 pc
Probe 0132-UVA1	1 pc
Battery	4 pcs



Conductivity/TDS/Salinity Testers
Page 1137-1140



pH Testers
Page 1141-1144



Water Quality Testers
Page 1145



Online Refractivity Sensors
Page 1146



Refractometers
Page 1147-1148



Handheld Airborne Particle Counters
Page 1149



Dry Laser Particle Size Analyzers
Page 1150



Opacimeters
Page 1151

PEN-TYPE CONDUCTIVITY/TDS/SALINITY TESTER CODE 0412-EB32



36

- Can measure the conductivity, TDS and salinity
- Suitable for water quality testing, aquaculture, food processing, scientific research, etc.
- The same series of electrodes can be replaced with each other
- Automatic temperature compensation
- With the stabilizing and locking functions of the reading
- Can be used normally in any environment with the background light
- Auto power off
- Probe protection level: IP67
- Lightweight, easy to carry and operate

"platinum black needle" electrode (included)



SPECIFICATION

Measuring range	conductivity 0~200.0μS/cm, 0~2000μS/cm, 0~20.00mS/cm
	TDS 0~100.0ppm, 0~1000ppm, 0~10.00ppt
	salinity 0~10.00ppt
	temperature 0~50°C
Resolution	conductivity 0.1μS/cm, 1μS/cm, 0.01mS/cm
	TDS 0.1ppm, 1ppm, 0.01ppt
	salinity 0.01ppt
	temperature 0.1°C
Accuracy	conductivity ±1%FS
	temperature ±0.5°C
Calibration mode	1~3 points
Power supply	4×1.5V AAA batteries
Dimension	178×40×40mm
Weight	133g



electrodes can be replaced

STANDARD DELIVERY

Main unit	1 pc
Standard solution	2 bottles
Test cup	2 pcs
1.5V AAA battery	4 pcs
Platinum black needle electrode	1 pc

IP65
WATERPROOF

PORTABLE CONDUCTIVITY/TDS METER CODE 0411-0200



- Reading mode: auto-read and continuous-read
- Automatic/manual temperature compensation
- Auto-hold feature senses and locks the measurement endpoint
- Cell constant is settable
- 1 point calibration with standard recognition
- Data capacity up to 200 sets for each parameter
- IP65 dust/waterproof
- Auto power off



standard solution
(included)



wristband (included)

SPECIFICATION

Conductivity	range	0.00 μ S/cm~200mS/cm
	resolution	0.01 μ S/cm minimum
	electronic unit accuracy	\pm 1.0%FS
	measurement accuracy	\pm 1.5%FS
	reference temperature	25°C/77°F
	calibration point	1
	standard recognition	84 μ S/cm, 1413 μ S/cm, 12.88mS/cm
TDS	range	0.00mg/L~300g/L
	resolution	0.01mg/L minimum
	accuracy	\pm 1.0%FS
Temperature	range	-5~110°C/23~230°F
	resolution	0.1°C/0.2°F
	accuracy	\pm 0.4°C/ \pm 0.7°F
Input	electrode with 5-pin aviation connector	
Power supply	rechargeable battery	
Dimension	80×225×35mm	
Weight	400g	

STANDARD DELIVERY

Main unit	1 pc
Electrode	1 pc
Electrode holder	2 pcs
Wristband	1 pc
Silicone rubber case	1 pc
AC/DC adapter and charging cable	1 pc
Standard solution	1 bottle

PORTABLE CONDUCTIVITY METER CODE 0413-EC33



36



standard solution (included)



glass conductivity electrode (optional)



high conductivity electrode (optional)



plastic conductivity electrode (included)

- 1~4 points automatic calibration, with calibration guidance and automatic inspection function
- The meter can recognize conductivity standard solutions automatically
- Manual and automatic temperature compensation functions for more accurate measurement
- The meter can be switched between conductivity and TDS
- 50 sets of data storage
- Featuring a foldable stand, suitable for multi scenario applications
- Probe protection level: IP57

SPECIFICATION

Conductivity	range	0~200mS/cm, divided into five ranges (0.00~19.99) μ S/cm, (20.0~199.9) μ S/cm, (200~1999) μ S/cm, (2.00~19.99)mS/cm, (20.0~199.9)mS/cm
	resolution	0.01/0.1/1 μ S/cm, 0.01/0.1mS/cm
	accuracy *	\pm (1.0%FS+1d)
	temperature compensation	0°C~100°C (manual or automatic)
	calibration mode	1~4 points
	electrode constant	0.1/1/10cm ⁻¹
TDS	range	(0~100)g/L
	resolution	0.01/0.1/1mg/L, 0.01/0.1g/L
	accuracy *	\pm (1.0%FS+1d)
	TDS conversion factor	0.40~1.00
Temperature	range	0°C~100°C
	resolution	0.1°C
	accuracy *	\pm (0.5°C+1d)
Standard solution		84 μ S/cm, 1413 μ S/cm, 12.88mS/cm
Power supply		3×1.5V AA batteries
Dimension		86×196×33mm
Weight		286g

*d is the resolution

STANDARD DELIVERY

Main unit	1 pc
Standard solution	3 bottles
1.5V AA battery	3 pcs
Plastic conductivity electrode	1 pc

OPTIONAL ACCESSORY

Glass conductivity electrode	0413-EC33-01
High conductivity electrode	0413-EC33-10



DATA
OUTPUT

CONDUCTIVITY METER CODE 0414-ED34

36



plastic conductivity
electrode (included)

- Equipped with rugged platinum-black conductivity electrode (K=1), rugged platinum-black coating, not only increases the surface area of the electrode and reduces the polarisation effect, but also improves the adhesion of the platinum-black to the metal, corrosion-resistant POM housing, built-in thermistor, automatic temperature compensation
- GLP data storage and management, USB data output
- 1~4 points automatic calibration, with calibration guidance and automatic inspection function
- The meter can recognize conductivity standard solutions automatically
- Manual and automatic temperature compensation functions for more accurate measurement
- The meter can switch conductivity, TDS, salinity
- Equipped with flexible electrode holder, easy to operate with one hand



standard solution (included)

SPECIFICATION

Conductivity	range	(0.00~19.99) μ S/cm, (20.0~199.9) μ S/cm (200~1999) μ S/cm, (2.00~19.99)mS/cm, (20.0~199.9)mS/cm
	resolution	0.01/0.1/1 μ S/cm, 0.01/0.1mS/cm
	accuracy *	\pm (1.0%FS+1d)
	temperature compensation	0 $^{\circ}$ C~50 $^{\circ}$ C (manual or automatic)
	calibration mode	1~4 points
	electrode constant	0.1/1/10cm ⁻¹
TDS	range	(0~100)g/L
	resolution	0.01/0.1/1mg/L, 0.01/0.1g/L
	accuracy *	\pm (1.0%FS+1d)
	TDS conversion factor	0.40~1.00
Temperature	range	0 $^{\circ}$ C~100 $^{\circ}$ C
	resolution	0.1 $^{\circ}$ C
	accuracy *	\pm (0.5 $^{\circ}$ C+1d)
Salinity	range	(0~100)ppt
Data storage		200 groups of USB data
Standard solution		84 μ S/cm, 1413 μ S/cm, 12.88mS/cm
Power supply		AC/DC adapter (9V)
Dimension		195×215×100mm
Weight		950g

*d is the resolution

STANDARD DELIVERY

Main unit	1 pc
Standard solution	3 bottles
Power adapter	1 pc
Plastic conductivity electrode	1 pc
Flexible electrode holder	1 pc
USB flash disk	1 pc
USB cable	1 pc

PEN-TYPE pH TESTER CODE 0432-HB22



36



- 3 types of pH electrodes: bulb type, plane type and puncture type
- Suitable for water quality testing, sewage treatment, food and cosmetics testing, agriculture and scientific research, etc.
- Can measure the ORP, the same series of electrodes can be replaced with each other
- Automatic temperature compensation
- Alarm function: the red backlight displays alarm mode
- With the stabilizing and locking functions of the reading
- Probe protection level: IP67
- Can be used normally in any environment with three colors of backlight
- Auto power off
- Lightweight, easy to carry and operate



ORP "platinum needle" electrode (optional)



SPECIFICATION

Measuring range	-2.00~16.00pH
	temperature 0~50°C
	ORP -1000mV~+1000mV
Resolution	0.01pH
	temperature 0.1°C
	ORP 1mV
Accuracy	±0.02pH
	temperature ±0.5°C
	ORP ±0.2%FS
Calibration mode	1~3 points
Standard solution	USA (pH buffers: 4.00, 7.00, 10.01) NIST (pH buffers: 4.01, 6.86, 9.18)
Power supply	4×1.5V AAA batteries
Dimension	178×40×40mm
Weight	133g

STANDARD DELIVERY

Main unit	1 pc
Standard solution	3 bottles (USA)
Test cup	3 pcs
KCl powder	1 bottle
1.5V AAA battery	4 pcs
pH bulb type electrode	1 pc

OPTIONAL ACCESSORY

pH plane type electrode	0432-HB-F
pH puncture type electrode	0432-HB-P
ORP electrode	0432-HB-O



IP65
WATERPROOF

PORTABLE pH METER
CODE 0431-0018

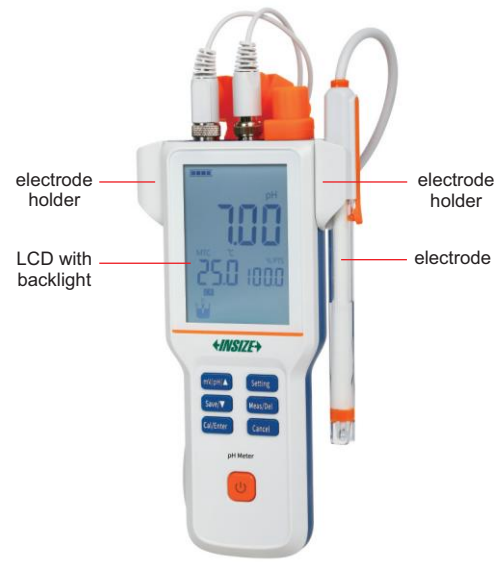

wristband (included)



KCl powder (included)



standard solution (included)

- Reading mode: auto-read and continuous-read
- Automatic/manual temperature compensation
- Auto-hold feature senses and locks the measurement endpoint
- 1 or 2 points calibration with standard recognition
- Data capacity up to 200 sets for each parameter
- IP65 dust/waterproof
- Auto power off

SPECIFICATION

pH	range	-2.00~18.00pH
	resolution	0.01pH
	electronic unit accuracy	±0.01pH
	measurement accuracy	±0.02pH
	calibration point	1 or 2
	standard recognition	NIST pH buffers: 4.01, 7.00, 10.01
Voltage	range	-1999~1999mV
	resolution	1mV
	accuracy	±0.1%FS
Temperature	range	-5~110°C/23~230°F
	resolution	0.1°C/0.2°F
	accuracy	±0.4°C/±0.7°F
Inputs	pH electrode: BNC (Q9) temp. probe: 4-pin aviation connector	
Power supply	rechargeable battery	
Dimension	80×225×35mm	
Weight	400g	

STANDARD DELIVERY

Main unit	1 pc
Electrode	1 pc
Electrode holder	2 pcs
Wristband	1 pc
Silicone rubber case	1 pc
AC/DC adapter and charging cable	1 pc
Standard solution	3 bottles
KCl powder	1 bottle

**PORTABLE pH METER
CODE 0430-HA21**



36



plastic pH electrode (included)



hydrofluoric acid/strong acid resistant glass pH electrode unit (optional)



standard solution (included)

- 1~3 points automatic calibration, with calibration guidance and automatic inspection function
- Manual and automatic temperature compensation functions for more accurate measurement
- The meter provides three types of reading stability criteria
- 50 sets of data storage
- Featuring a foldable stand, suitable for multi scenario applications
- Probe protection level: IP57

SPECIFICATION

pH	range	0.00~14.00pH
	resolution	0.1/0.01pH
	accuracy*	±(0.01pH+1d)
	temperature compensation	0°C~100°C (manual or automatic)
	calibration mode	1~3 points
mV	range	-1000mV~+1000mV
	resolution	1mV
	accuracy*	±(0.2%FS+1d)
Temperature	range	0°C~100°C
	resolution	0.1°C
	accuracy*	±(0.5°C+1d)
Standard solution	pH buffers: 4.00, 7.00, 10.01	
Power supply	3×1.5V AA batteries	
Dimension	86×196×33mm	
Weight	292g	

*d is the resolution

STANDARD DELIVERY

Main unit	1 pc
Standard solution	3 bottles
1.5V AA battery	3 pcs
Plastic pH electrode	1 pc

OPTIONAL ACCESSORY

Hydrofluoric acid/strong acid resistant glass pH electrode	0430-HA21-A
Strong alkali/high salt/high temperature pH electrode	0430-HA21-B



DATA
OUTPUT

BENCHTOP pH METER CODE 0434-HD24



- Equipped with glass pH electrode, using a special gelation process, the solution inside the electrode will not flow, no air bubbles even when inverted, and the electrode glass adopts a thick film process, so there is no need to worry about the sphere rupture caused by ordinary collision
- GLP data storage and management, USB data output
- 1~3 points automatic calibration, with calibration guidance and automatic inspection function
- Automatic recognition of pH buffers, automatic display of slope at the end of calibration
- Manual and automatic temperature compensation functions for more accurate measurement
- Equipped with flexible electrode holder, easy to operate with one hand



standard solution (included)

SPECIFICATION

pH	range	-2.00~20.00pH
	resolution	0.1/0.01pH
	accuracy *	±(0.01pH+1d)
	temperature compensation	0°C~100°C (manual or automatic)
	calibration mode	1~3 points
mV	range	-2000mV~+2000mV
	resolution	1mV
	accuracy *	±(0.1%FS+1d)
Temperature	range	0°C~100°C
	resolution	0.1°C
	accuracy *	±(0.5°C+1d)
Data storage		200 groups of USB data
Standard solution		USA (pH buffers: 4.00, 7.00, 10.01) NIST (pH buffers: 4.01, 6.86, 9.18) China series, user-defined solutions
Power supply		AC/DC adapter (9V)
Dimension		195×215×100mm
Weight		950g

* d is the resolution

STANDARD DELIVERY

Main unit	1 pc
Standard solution	3 bottles (USA)
Power adapter	1 pc
Glass pH electrode	1 pc
Temperature electrode	1 pc
Flexible electrode holder	1 pc
USB flash disk	1 pc
USB cable	1 pc

WATER QUALITY TESTER CODE 0410-EA31



36



- Suitable for measuring tap water, purified water, underground water, surface water (unpolluted) and other drinking water, to determine microorganisms and pesticide residues in water
- Use UV absorption method to measure COD, TOC, UV275 parameters of drinking water, and measure the conductivity to determine TDS of drinking water
- Can simultaneously measure 6 parameters: COD (chemical oxygen demand), TOC (total organic carbon), UV275 (ultraviolet wavelength 275nm), TDS (total dissolved solids), EC (electric conductivity), T (temperature) for comprehensive evaluation of water quality
- With intelligent scoring feature: 4 colors backlight indicate 4 grades of water quality
- Automatic temperature compensation
- Probe protection level: IP67

SPECIFICATION

Measuring range	COD	0~50 mg/L
	TOC	0~50 mg/L
	Conductivity	0~4000 uS/cm
	TDS	0~2000 ppm
	UV275	0~1 au/cm
	Temperature	0-50°C
Resolution	COD	0.01 mg/L
	TOC	0.01 mg/L
	Conductivity	1 uS/cm
	TDS	1 ppm
	UV275	0.001 au/cm
	Temperature	0.1°C
Accuracy	COD	0~5mg/L , ±0.5mg/L 5~50mg/L , ±10%
	TOC	0~5mg/L , ±0.5mg/L 5~50mg/L , ±10%
	Conductivity	±3.5%FS
	TDS	±3.5%FS
	UV275	0~0.1au/cm, ±0.01au/cm 0.1~1au/cm, ±10%
	Temperature	±1°C
Power supply	2×1.5V AAA batteries	
Dimension	157×37×14mm	
Weight	68g	

water quality grade

<table border="1"> <tr> <td>COD</td><td>TOC</td><td>TDS</td></tr> <tr> <td>0.2</td><td>0.2</td><td>61</td></tr> <tr> <td colspan="3">99 (Excellent)</td> </tr> </table>			COD	TOC	TDS	0.2	0.2	61	99 (Excellent)			<table border="1"> <tr> <td>COD</td><td>TOC</td><td>TDS</td></tr> <tr> <td>1.3</td><td>1.7</td><td>61</td></tr> <tr> <td colspan="3">88 (Good)</td> </tr> </table>			COD	TOC	TDS	1.3	1.7	61	88 (Good)			<table border="1"> <tr> <td>COD</td><td>TOC</td><td>TDS</td></tr> <tr> <td>2.9</td><td>4.0</td><td>60</td></tr> <tr> <td colspan="3">76 (Normal)</td> </tr> </table>			COD	TOC	TDS	2.9	4.0	60	76 (Normal)			<table border="1"> <tr> <td>COD</td><td>TOC</td><td>TDS</td></tr> <tr> <td>10.8</td><td>15.4</td><td>30</td></tr> <tr> <td colspan="3">33 (Poor)</td> </tr> </table>			COD	TOC	TDS	10.8	15.4	30	33 (Poor)		
COD	TOC	TDS																																													
0.2	0.2	61																																													
99 (Excellent)																																															
COD	TOC	TDS																																													
1.3	1.7	61																																													
88 (Good)																																															
COD	TOC	TDS																																													
2.9	4.0	60																																													
76 (Normal)																																															
COD	TOC	TDS																																													
10.8	15.4	30																																													
33 (Poor)																																															
COD (mg/L)	TOC (mg/L)	TDS (ppm)	Colour	Score	Grade																																										
0~0.75	0~1.25	0~250	blue	90~100	Excellent																																										
0.75~1.5	1.25~2.5	250~500	green	80~90	Good																																										
1.5~3	2.5~5	500~1000	yellow	60~80	Normal																																										
3~7.5	5~12.5	1000~2000	red	0~60	Poor																																										

STANDARD DELIVERY

Main unit	1 pc
Pure water calibration cup	1 pc



BUILT-IN
BLUETOOTH

IP67
WATERPROOF

ONLINE REFRACTIVITY SENSORS

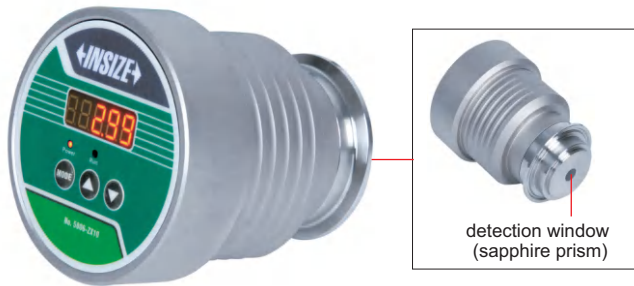

5806-ZX10

- Based on the principle of light refraction and total reflection, measure the concentration of coolant, sugar liquid and other liquids in real time
- High measuring accuracy and wide measuring range
- Automatic temperature compensation
- Built-in bluetooth
- Screw thread, flange, chuck and other installation methods can be customized
- Use sapphire prism, high hardness and wear-resistant
- Resistance to dirty, easy to clean
- Protection level of probe part: IP67

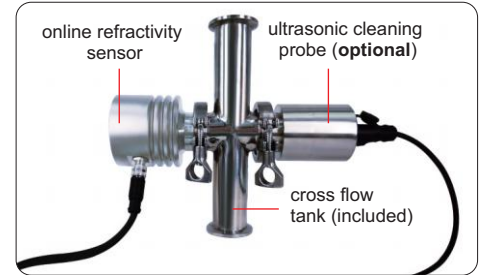

36

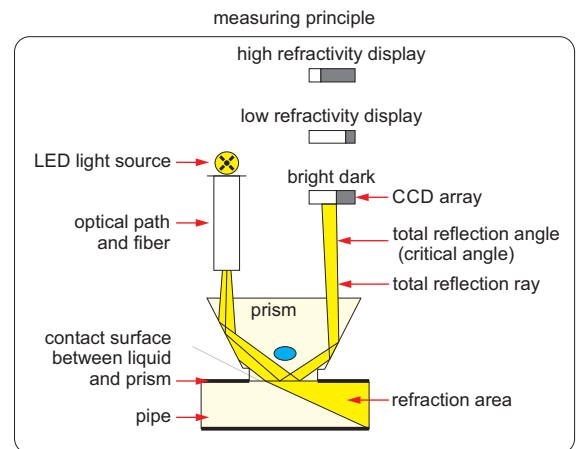

SPECIFICATION

Code	5806-ZX10	5806-ZX20
Type	flat-top	round-top (self-cleaning)
Measuring range	Brix 0.00~90.00%	
	refractivity 1.33299~1.51782	
	temperature 0~60°C	
Accuracy	Brix ±0.20%	
	refractivity ±0.00030	
	temperature ±0.5°C	
Resolution	Brix 0.01%	
	refractivity 0.00001	
	temperature 0.1°C	
Measuring mode	immersion	
Pressure resistance	≤ 1MPa	
Measuring speed	1time/5s	
Output (customizable)	analog output: (4~20)mA for Brix (0.00~90.00)%	
	digital output: RS485	
Power supply	DC 24V±10%, working current <100mA	
Dimension	Ø88×109mm	Ø88×133mm
Weight	827g	882g

application example



STANDARD DELIVERY

Main unit	1 pc
Cross flow tank	1 pc
Clamp	4 pcs
Polytef gasket	6 pcs
Connector	2 pcs
Wall piece	1 pc

OPTIONAL ACCESSORY

Ultrasonic cleaning probe	5806-ZX-UCP
High pressure water/air cleaning device	5806-ZX-HPC
Automatic brush cleaning system	5806-ZX-AC

SEA WATER BAUME METER CODE 5808-SW25

- Rapid measurement of sea water and salt water concentration
- Suitable for measuring the content of NaCl in aqueous solutions, snowmelt, brine, sea water and other saline solutions
- Automatic temperature compensation
- Display content and refractive index
- Automatic power off



VIDEO

SPECIFICATION

Measuring range	-1.00~25.00°Bé (1.3270~1.3950RI)
Accuracy	±0.2°Bé (±0.0003RI)
Resolution	0.01°Bé (0.0001RI)
Power supply	1×AAA battery
Dimension	121×58×25mm
Weight	90g

STANDARD DELIVERY

Main unit	1 pc
Dropper	1 pc
Battery (AAA)	1 pc

dropper (included)



DIGITAL REFRACTOMETER CODE ISQ-DRM31

- Quickly measure the concentration of coolant, sugar solution, juice and drinks
- Two measurement modes:
single measurement and automatic average multiple measurement
- Two units: brix and refractive index
- Refer to the refraction factor of coolant, for example:
the refraction factor of grinding emulsion is 2.1,
the reading value is 6%, so the actual concentration is $(2.1 \times 6\%) = 12.6\%$
- Automatic power off



SUITABLE FOR WATER
BASED COOLANT



VIDEO

SPECIFICATION

Measuring range	0~50% (1.3330~1.4200RI)
Accuracy	±0.2% (±0.0003RI)
Resolution	0.1% (0.0001RI)
Power supply	1×AAA battery
Dimension	121×58×25mm
Weight	90g

STANDARD DELIVERY

Main unit	1 pc
Dropper	1 pc
Battery (AAA)	1 pc

dropper (included)

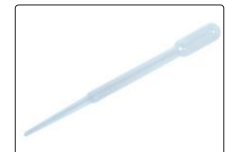

MINI DIGITAL REFRACTOMETER CODE 5801-A55

- Quickly measure the concentration of coolant
- Automatic temperature compensation
- Brix and refractive index can be displayed
- Refer to the refraction coefficient of coolant, for example:
the refraction coefficient of grinding emulsion is 2.1, the reading
value is 6%, so the actual concentration is $(2.1 \times 6\%) = 12.6\%$
- Automatic power off



SUITABLE FOR WATER
BASED COOLANT



VIDEO

SPECIFICATION

Measuring range	0~50% (1.3330~1.4200RI)
Accuracy	±0.2% (±0.0003RI)
Resolution	0.1% (0.0001RI)
Power supply	built-in 3.7V rechargeable lithium battery
Dimension	147×46×27mm
Weight	115g (including battery)

STANDARD DELIVERY

Main unit	1 pc
Dropper	1 pc

dropper (included)





SUITABLE FOR WATER BASED COOLANT

PORTABLE REFRACTOMETERS

- Quickly measure the concentration of coolant, sugar solution, juice and drinks
- Refer to the refraction factor of coolant, for example: the refraction factor of grinding emulsion is 2.1, the reading value is 6%, so the actual concentration is $(2.1 \times 6\%) = 12.6\%$



SPECIFICATION

Code	ISQ-RM10	ISQ-RM30	ISQ-RM80
Measuring range	0~10%	0~32%	0~80%
Accuracy (20°C)	±0.1%	±0.2%	±0.5%
Resolution	0.1%	0.2%	0.5%
Dimension	27×40×184mm	27×40×160mm	27×40×137mm
Weight	230g	207g	187g



PORTABLE REFRACTOMETER FOR AUTOMOTIVE LIQUID CODE 5802-A510

- Measure the freezing point of the antifreeze and the concentration of urea in diesel exhaust fluid
- Measure the specific gravity of battery fluid

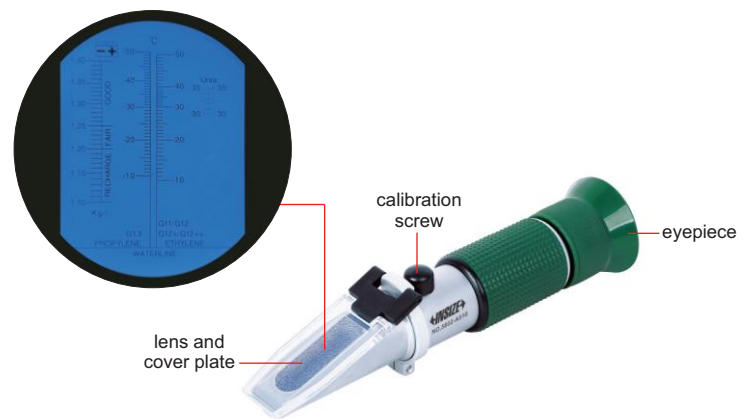

SPECIFICATION

Measuring object	ethylene glycol	propylene glycol	urea	battery fluid
Measuring range	-50~0°C	-50~0°C	30~35%	1.10~1.40kg/l
Accuracy	±5°C	±5°C	±1%	±0.02kg/l
Resolution	1°C	1°C	1%	0.01kg/l
Dimension	27×40×160mm			
Weight	172g			

PORTABLE REFRACTOMETER FOR DIESEL EXHAUST FLUID CODE 5803-B40

- Measure the concentration of urea in diesel exhaust fluid
- Wide measuring range

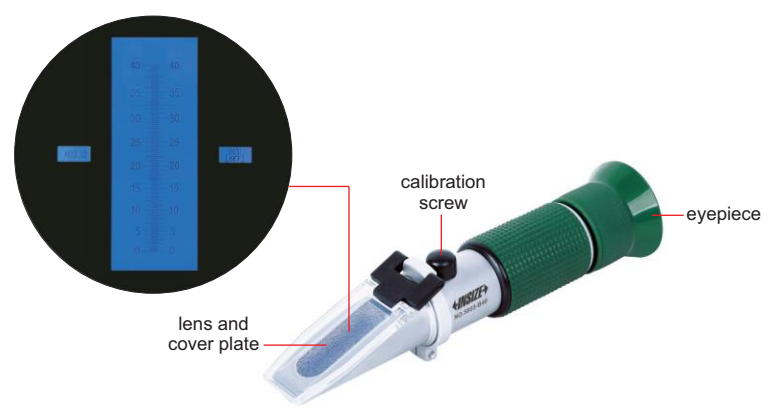

SPECIFICATION

Measuring range	0~40%
Accuracy	±0.2% (20°C)
Resolution	0.2%
Dimension	27×40×160mm
Weight	170g

HANDHELD AIRBORNE PARTICLE COUNTER CODE 0811-CA01

DATA
OUTPUT



high efficiency filter
(included)

36

- Widely used in electronic production clean room testing, filter leakage detection, monitor biological safety, HVAC systems, computer rooms, food packaging environments, pharmaceutical and medical device production environments, hospital clean operating rooms, automotive spraying environments, etc.
- Using semiconductor laser sensor
- Measures the size and number of dust particles per unit volume of air in clean environments, and can be set to alarm at different purification levels
- Simultaneous counting of six counting channels (0.3µm, 0.5µm, 1µm, 3µm, 5µm, 10µm), and can be stored according to the room number respectively, according to the calculation of the upper confidence limit of 95% for each room (UCL value)
- It can be connected to a PC data acquisition system for remote control



SPECIFICATION

Sampling flow	range	2.83L/min (0.1ft ³)
	accuracy	±5%
Particle	particle diameter passage	0.3µm, 0.5µm, 1µm, 3µm, 5µm, 10µm, simultaneous counting of six particle diameters
	repeatability	≤10%FS
	error of particle sizes	±30% (0.5µm, 5µm)
	accuracy	±30%FS (0.5µm)
Self-cleaning time		≤10min
Delay sampling time		0~99s
Sampling time		1s~9999s
Sampling mode		single, repeated, continuous, calculate, remote
Unit conversion		m ³ , ft ³
Counting mode		cumulative value, difference value, concentration value
UCL setting*		sampling points (A): set from 2 to 9, sampling times per point (L): set from 2 to 9, location: set from 0 to 999
Alarm setting		the instrument is equipped with a cleanroom level alarm function, which will alarm when it exceeds the standard of class 100, 1000, 10000, 100000, 300000, 1000000, and will also alarm when the battery voltage is too low
Data storage		store 1000 sets of data (including particle size, data, environmental data, time, sample volume, data location), no data loss after power failure
Environmental requirement		temperature: 0~40°C, relative humidity: 20~90%, no condensation, the instrument should be used in a non-corrosive air environment
Power supply		16.8V rechargeable Li-ion battery, working time 8h
Dimension		230×130×450mm
Weight		600g

* upper confidence limit of 95%

STANDARD DELIVERY

Main unit	1 pc
Isokinetic sampling port	1 pc
High efficiency filter	1 pc
Communication cable	1 set
Adapter	1 pc
USB disk	1 pc

OPTIONAL ACCESSORY

Printer	0811-CA01-PRINTER
Temperature and humidity sensors	0811-CA01-THW
Tripod	0701-TR175

DRY LASER PARTICLE SIZE ANALYZER (BASIC TYPE) CODE 0815-D300



- According to GB/T 19077-2016, ISO 13320:2009
- Suitable for any powdered material, particularly good for materials which react with water, or shape change in liquids
- It can be used for metal and non-metal powder, cements, pharmaceuticals, fillers, catalysts, additives, lubricants, coal powder, mud and sand, dust, foodstuffs, graphites, photographic materials, calcium carbonate, kaolin and other powdery materials
- Using air as the dispersing medium and the principle of turbulent dispersion, ensure that the sample is thoroughly dispersed
- Based on the MIE scattering theory, converging Fourier transform optical path, and with He-Ne laser photodetectors
- Just need put in the sample, dust collection, air supply, feeding are all done automatically

SPECIFICATION

Measuring range		0.1µm~300µm
Channels number		56pcs
Accuracy *		≤1%
Repeatability *		≤1%
Dispersion method		dry-turbulence dispersion
Dispersing medium		compressed air
Test speed		<1min for each time
Software function	analysis mode	free distribution, R-R distribution, logarithm normal distribution, mesh number classification
	statistic method	volume distribution, quantity distribution
	statistic comparison	several testing results of samples, different batches of samples testing result, samples before and after processing, test result of samples in different time
	user-defined analysis	figure out percentage according to the particle size figure out particle size according to the percentage figure out percentage according to the particle size range
	operation mode	automatically control air flow speed, dispersion, test and analysis
test report		word, excel, photo (bmp), text etc.
Power supply		220V, 50Hz
Dimension		main unit: 765×450×325mm dispersion unit: 260×285×135mm
Weight		36kg

* Deviation of D50 on standard sample

STANDARD DELIVERY

Main unit	1 pc
Air compressor	1 pc
Dust collector	1 pc
Diamond standard sample	1 pc
Sampling spoon	2 pcs
Computer	1 pc
Toolkit *	1 set

* Including mirror paper, screwdriver, fuse, PTFE thread seal tape, brush, rubber suction bulb

test principle

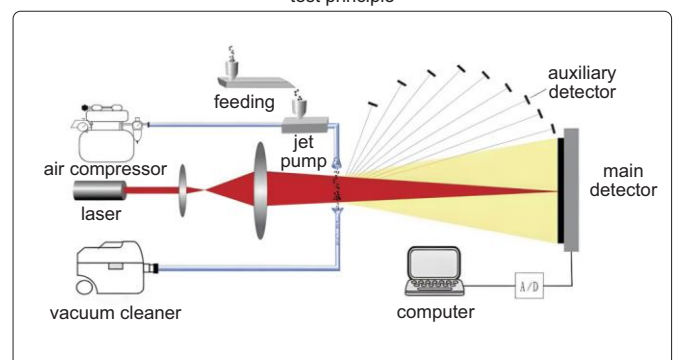

OPACIMETER CODE TSM-C11E



standard filter (included)



- According to ISO11614
- Used to test the visible contaminants in emissions (exhaust smoke) from the compression combustion (diesel) engine. Suitable for environmental protection, motor vehicle testing, engine manufacturing, automobile manufacturing and automobile repair
- LCD display and touch screen, can test "opacity" and "light absorption coefficient", simple and intuitive
- With "free acceleration test" and "transient test" function, automatic data processing
- Use sampling (split) test and "air curtain" protection technology, prevent the optical system from being polluted by exhaust smoke
- Test chamber is controlled under constant temperature, prevent the moisture condensation and temperature fluctuation for accurate measurements
- Automatic preheating and zeroing
- RS232 serial port communicates with external computer

SPECIFICATION

Measuring range	opacity Ns	0~99.9%
	light absorption coefficient K	0~16.0m ⁻¹
	rotary speed	300~8000rpm
	oil temperature	0~120°C
Resolution	opacity Ns	0.1%
	light absorption coefficient K	0.01m ⁻¹
	rotary speed	1rpm
	oil temperature	1°C
Accuracy	opacity Ns	±2%
	light absorption coefficient K	±0.05m ⁻¹
	rotary speed	±1%
	oil temperature	±2°C
Warm-up		15min
Effective length of optical path		215mm
Equivalent length of optical path		430mm
Environment	temperature	5~40°C
	relative humidity	5~95%RH
Power supply		AC220V 50Hz
Dimension	control unit	370×280×220mm
	measurement unit	435×230×360mm
Weight	control unit	5.5kg
	measurement unit	6.5kg



speed adaptor (optional)

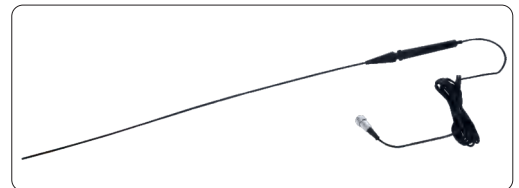

oil temperature sensor (optional)

STANDARD DELIVERY

Main unit	Control unit	1 pc
	Measurement unit	1 pc
Sampling probe		1 pc
Connection cable		1 pc
Standard filter		1 pc

OPTIONAL ACCESSORY

Printer	TSM-C11-PRINT
Speed adaptor	TSM-C11-S
Oil temperature sensor	TSM-C11-T
Software and RS-232C cable	TSM-C11-SOFTWARE



Balances
Page 1153-1163



Density Balances
Page 1164-1165



Moisture Analyzers
Page 1167



Weighing Scales
Page 1168-1169



Electronic Pocket Scales
Page 1170



Platform Scales
Page 1171



Parcel Scales
Page 1172



Floor Scales
Page 1173



Forklift Scales
Page 1174



Electronic Crane Scales
Page 1175-1179



Weights
Page 1182-1185



GSM Cutters
Page 1185

ELECTRONIC ANALYTICAL BALANCES

DATA
OUTPUT



37



printer (optional)



calibration weight
(included in 8310-120M,
8310-210M and 8310-320M)



8310-320A

- Rear electromagnetic sensor
- Separated display unit and weighing unit, reduce vibration error
- Digital processing technology improves reading stability and response speed for micro sample addition, sample weight and balance reading is consistent
- Unit: g, oz, ct, lb
- Weighing, counting, taring, percentage
- Data output

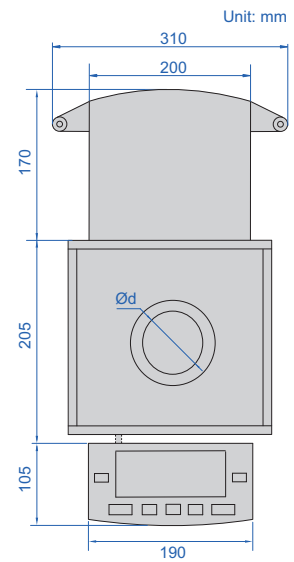
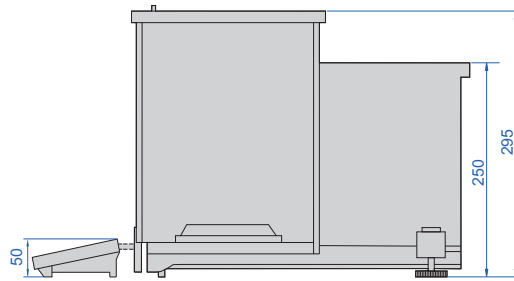

SPECIFICATION

Code	8310-120M	8310-210M	8310-320M	8310-120A	8310-210A	8310-320A
Calibration	external calibration			internal calibration		
Maximum weighing	120g	210g	320g	120g	210g	320g
Minimum weighing	10mg	10mg	10mg	10mg	10mg	10mg
Resolution (d)	0.1mg	0.1mg	0.1mg	0.1mg	0.1mg	0.1mg
Verification interval (e)	1mg	1mg	1mg	1mg	1mg	1mg
Accuracy (m is load)	m≤50g: ±0.5mg; 50g<m≤200g: ±1mg; m>200g: ±1.5mg			m≤50g: ±0.5mg; 50g<m≤200g: ±1mg; m>200g: ±1.5mg		
Repeatability	±0.1mg					
Linearity	±0.2mg					
Stabilization time	2.5s					
Weighing pan size (Ød)	Ø90mm					
Output	RS232					
Operation temperature	10~30°C					
Operation humidity	20~85%RH					
Power supply	power adapter (12V/2A)					
Dimension (L×W×H)	480×310×320mm					
Weight	6kg					

OPTIONAL ACCESSORY

RS232 cable	8304-CABLE *
Printer	8303-PRINTER

* Used to connect with computers

DATA
OUTPUT

ELECTRONIC ANALYTICAL BALANCES (BASIC TYPE)



37



8304-120



calibration weight
(included)



printer (optional)

- Downward-mounted electromagnetic sensor
- Weighing, counting, taring, percentage
- LCD display, with backlight
- Data output
- Unit: g, ct, oz, lb

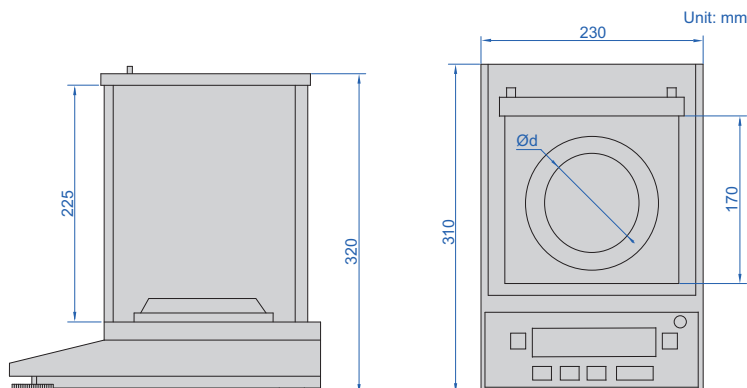

Unit: mm

SPECIFICATION

Code	8304-120	8304-220
Maximum weighing	120g	220g
Minimum weighing	10mg	10mg
Resolution (d)	0.1mg	0.1mg
Verification interval (e)	1mg	1mg
Accuracy (m is load)	m≤50g: ±0.5mg; 50g<m≤120g: ±1mg	m≤50g: ±0.5mg; 50g<m≤200g: ±1mg; m>200g: ±1.5mg
Repeatability	±0.2mg	
Linearity	±0.2mg	
Stabilization time	2.5s	
Output	RS232	
Weighing pan size (Ød)	Ø90mm	
Operation temperature	10~30°C	
Operation humidity	20~85%RH	
Power supply	power adapter (12V/2A)	
Dimension (L×W×H)	230×310×320mm	

OPTIONAL ACCESSORY

RS232 cable	8304-CABLE *
Printer	8303-PRINTER
Data output cable (keyboard format)	7302-8304 page 22

*Used to connect with computers

ELECTRONIC PRECISION BALANCES

DATA
OUTPUT

37



8303-520

- Aluminum alloy shell, wind shield, three side glass sliding doors
- Electromagnetic balance sensor
- Unit: g, ct, ozt, oz, gn, dwt, mg
- Weighing, counting, taring
- Data output
- With a hook at the bottom



class F1 calibration weight (included)



printer (optional)

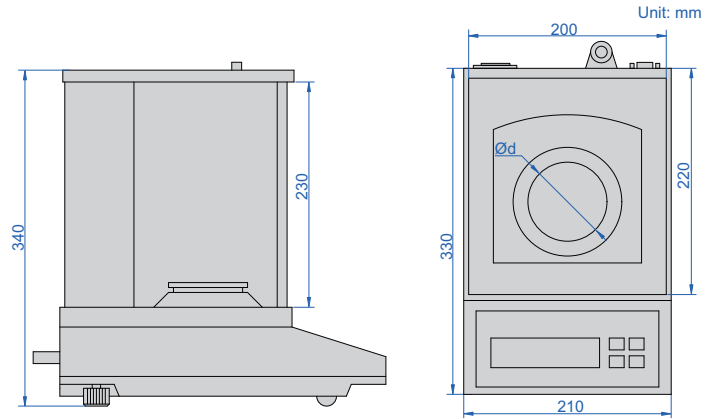

SPECIFICATION

Code	8303-220	8303-320	8303-520	8303-620	8303-1020	8303-1520	8303-2020
Maximum weighing	220g	320g	520g	620g	1020g	1520g	2020g
Minimum weighing	20mg	20mg	100mg	100mg	100mg	100mg	100mg
Resolution (d)	1mg	1mg	1mg	1mg	1mg	1mg	1mg
Verification interval (e)	10mg	10mg	10mg	10mg	10mg	10mg	10mg
Accuracy (m is load)	m≤50g: ±5mg 50g<m≤200g: ±10mg m>200g: ±15mg		m≤500g: ±5mg m>500g: ±10mg				m≤500g: ±5mg 500g<m≤2000g: ±10mg m>2000g: ±15mg
Weighing pan size (Ød)	Ø80mm				Ø120mm		
Operation temperature	15~30°C		18~23°C				
Operation humidity	40%~80%RH		50%~70%RH				
Power supply	220V, 50/60Hz						
Dimension (L×W×H)	330×210×340mm						

OPTIONAL ACCESSORY

RS232 cable	8301-CABLE *
Printer	8303-PRINTER
Data output cable (keyboard format)	7302-8001 page 22
Wireless transmitter (receiver is needed)	7315-8301 page 8

*Used to connect with computers

DATA
OUTPUT

TOUCH
SCREEN

INTERNAL
CALIBRATION

ELECTRONIC PRECISION BALANCES

37



class F1 calibration weight (included)



printer (optional)



8319-320

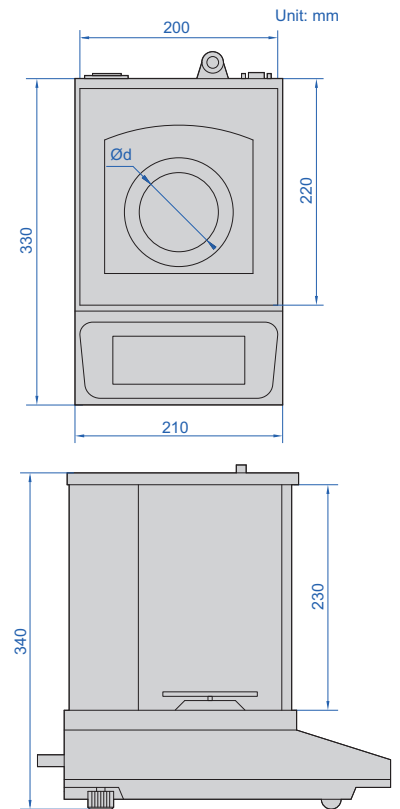

- Built-in calibration weights, automatic internal calibration
- Large touchscreen display
- Weighing, counting, taring, percentage display, density detection
- Aluminium alloy shell, wind shield, three side glass sliding doors
- Unit: g, ct, ozt, oz, gn, dwt, mg
- Electromagnetic balanced sensor
- With a hook at the bottom
- Data output

SPECIFICATION

Code	8319-220	8319-320	8319-520	8319-620	8319-1020	8319-1520
Maximum weighing	220g	320g	520g	620g	1020g	1520g
Minimum weighing	20mg	20mg	100mg	100mg	100mg	100mg
Resolution (d)	1mg	1mg	1mg	1mg	1mg	1mg
Verification interval (e)	10mg	10mg	10mg	10mg	10mg	10mg
Accuracy (m is load)	m≤50g: ±5mg 50g<m≤200g: ±10mg m>200g: ±15mg		m≤500g: ±5mg m>500g: ±10mg			
Weighing pan size (Ød)	Ø80mm				Ø120mm	
Operation temperature	15~30°C		18~23°C			
Operation humidity	40%~80%RH		50%~70%RH			
Power supply	220V, 50/60Hz					
Dimension (L×W×H)	330×210×340mm					

STANDARD DELIVERY

Main unit	1 pc
Calibration weight	1 pc

OPTIONAL ACCESSORY

RS232 cable	8301-CABLE *
Printer	8303-PRINTER
Data output cable (keyboard format)	7302-8001 page 22
Wireless transmitter (receiver is needed)	7315-8301 page 8

* Used to connect with computers

ELECTRONIC BALANCES

DATA
OUTPUT

37



8301-3000



windshield
(included in 8301-300,
8301-600 and 8301-1200)



calibration weight
(included in 8301-300,
8301-600 and 8301-1200)

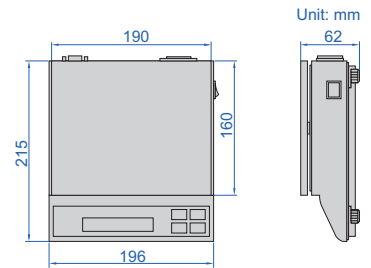

- Automatic zero when power on
- Unit: g (gram), ct (carat), ozt (troy ounce)
- Weighing, counting, taring
- Overload alarm
- Data output

SPECIFICATION

Code	8301-300	8301-600	8301-1200	8301-3000	8301-6000
Maximum weighing	300g	600g	1200g	3000g	6000g
Minimum weighing	0.2g	0.2g	0.2g	2g	2g
Resolution (d)	0.01g	0.01g	0.01g	0.1g	0.1g
Verification interval (e)	0.1g	0.1g	0.1g	1g	1g
Accuracy (m is load)	m≤50g: ±0.05g; 50g<m≤200g: ±0.1g; m>200g: ±0.15g		m≤500g: ±0.05g; m>500g: ±0.1g	m≤500g: ±0.5g; 500g<m≤2000g: ±1g; m>2000g: ±1.5g	
Weighing pan size	Ø135mm			190×160mm	
Operation temperature	0~40°C				
Operation humidity	≤80%RH				
Power supply	220V, 50/60Hz				
Dimension (L×W×H)	215×196×62mm				

OPTIONAL ACCESSORY

RS232 cable	8301-CABLE*
Data output cable (keyboard format)	7302-8001 page 22
Wireless transmitter (receiver is needed)	7315-8301 page 8

*Used to connect with computers



DATA
OUTPUT

ELECTRONIC BALANCES (STANDARD TYPE)

37



8305-5000

Unit: mm



calibration weight
(included in 8305-2000
and 8305-3000)

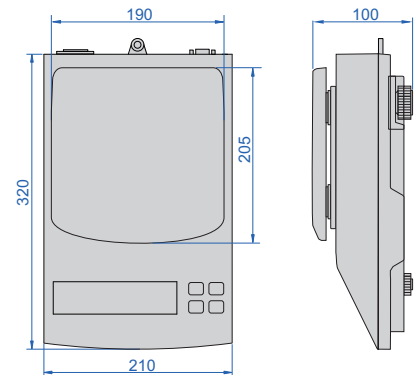

- LCD with back light
- Unit: g, ct, ozt, oz, GN, dwt, lb, kg
- Weighing, counting, taring
- With a hook at the bottom
- Data output

SPECIFICATION

Code	8305-2000	8305-3000	8305-5000	8305-6000
Maximum weighing	2kg	3kg	5kg	6kg
Minimum weighing	0.5g	0.5g	0.5g	0.5g
Resolution (d)	0.01g	0.01g	0.01g	0.01g
Verification interval (e)	0.1g	0.1g	0.1g	0.1g
Accuracy (m is load)	m≤0.5kg: ±0.05g; 0.5kg<m≤2kg: ±0.1g	m≤0.5kg: ±0.05g; 0.5kg<m≤2kg: ±0.1g m>2kg: ±0.15g	m≤0.5kg: ±0.05g; 0.5kg<m≤2kg: ±0.1g m>2kg: ±0.15g	m≤0.5kg: ±0.05g; 0.5kg<m≤2kg: ±0.1g m>2kg: ±0.15g
Weighing pan size	190×205mm			
Output	RS232			
Operation temperature	0~40°C			
Operation humidity	≤80%RH			
Power supply	220V, 50/60Hz			
Dimension (L×W×H)	320×210×100mm			

OPTIONAL ACCESSORY

RS232 cable	8301-CABLE*
Printer	8303-PRINTER
Data output cable (keyboard format)	7302-8001 page 22
Wireless transmitter (receiver is needed)	7315-8301 page 8



printer (optional)

*Used to connect with computers

INDUSTRIAL ELECTRONIC BALANCES (BASIC TYPE)

POPULAR
MODEL



37



printer (optional)



8306-20AD

- Double weighing pan in stainless steel and plastic
- Weighing, simple counting, taring
- Strain balance sensor
- LCD display, with backlight
- Unit: g, lb, ct, oz
- Overload alarm

Unit: mm

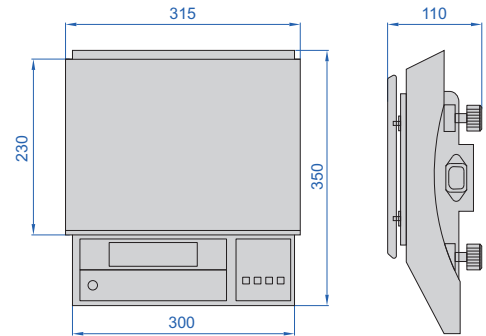

SPECIFICATION

Operation temperature	-10~40°C
Operation humidity	≤85%RH
Dimension of pan	315×230mm
Power supply	rechargeable lead acid battery (6V/4Ah)
Output	≤2s

Code	Maximum weighing	Resolution (d)	Minimum weighing	Verification interval (e)	Number of verification interval (n)	Accuracy (m is load)	Output	
8306-10	10kg	1g	20g	10g	1000	m≤5kg: ±5g; m>5kg: ±10g	no	
8306-15	15kg	1g	20g	10g	1500	m≤5kg: ±5g; m>5kg: ±10g		
8306-20	20kg	1g	20g	10g	2000	m≤5kg: ±5g; m>5kg: ±10g		
8306-30	30kg	1g	20g	10g	3000	m≤5kg: ±5g; 5kg<m≤20kg: ±10g; m>20kg: ±15g		
8306-5A	5kg	0.1g	5g	1g	5000	±0.5g		
8306-10A	10kg	0.1g	5g	1g	10000	m≤5kg: ±0.5g; m>5kg: ±1g		
8306-15A	15kg	0.1g	5g	1g	15000	m≤5kg: ±0.5g; m>5kg: ±1g		
8306-20A	20kg	0.1g	5g	1g	20000	m≤5kg: ±0.5g; m>5kg: ±1g		
8306-10D	10kg	1g	20g	10g	1000	m≤5kg: ±5g; m>5kg: ±10g		RS232
8306-15D	15kg	1g	20g	10g	1500	m≤5kg: ±5g; m>5kg: ±10g		
8306-20D	20kg	1g	20g	10g	2000	m≤5kg: ±5g; m>5kg: ±10g		
8306-30D	30kg	1g	20g	10g	3000	m≤5kg: ±5g; 5kg<m≤20kg: ±10g; m>20kg: ±15g		
8306-5AD	5kg	0.1g	5g	1g	5000	±0.5g		
8306-10AD	10kg	0.1g	5g	1g	10000	m≤5kg: ±0.5g; m>5kg: ±1g		
8306-15AD	15kg	0.1g	5g	1g	15000	m≤5kg: ±0.5g; m>5kg: ±1g		
8306-20AD	20kg	0.1g	5g	1g	20000	m≤5kg: ±0.5g; m>5kg: ±1g		

OPTIONAL ACCESSORY

RS232 cable	8306-CABLE *
Printer	8306-PRINTER

* Used to connect with computers



DATA
OUTPUT

INDUSTRIAL ELECTRONIC BALANCES

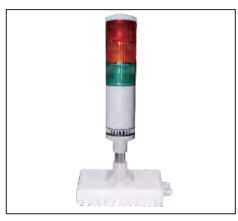

alarm light (optional)



printer (optional)



8307-15K

- Zero-setting, weighing, counting, checking alarm
- Subtracting tare value, accumulation, percentage display
- Overload alarm
- LCD display, with backlight
- Automatic power off
- Data output
- Unit: kg, lb, g, oz, t (ola)

SPECIFICATION

Operation temperature	-10~40°C
Operation humidity	30%~80%RH
Dimension of pan	300×225mm
Power supply	rechargeable lead acid battery (6V/4Ah)
Output	RS232

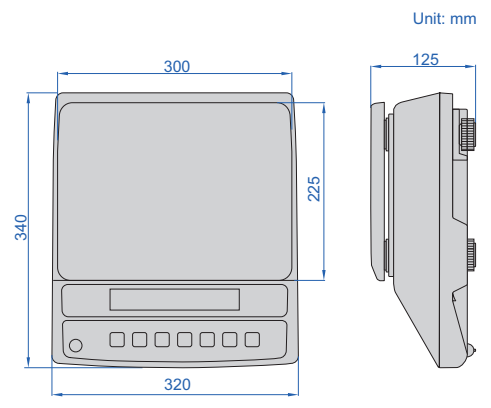

Code	Maximum weighing	Resolution (d)	Minimum weighing	Verification interval (e)	Number of verification interval (n)	Accuracy (m is load)
8307-6K	6kg	0.05g	2.5g	0.1g	60000	m≤500g: ±0.05g; 500g<m≤2kg: ±0.1g; m>2kg: ±0.15g
8307-15K	15kg	0.1g	5g	1g	15000	m≤5kg: ±0.5g; m>5kg: ±1g
8307-30K	30kg	0.2g	10g	1g	30000	m≤5kg: ±0.5g; 5kg<m≤20kg: ±1g; m>20kg: ±1.5g
8307-3KA	3kg	0.05g	2.5g	0.1g	30000	m≤500g: ±0.05g; 500g<m≤2kg: ±0.1g; m>2kg: ±0.15g
8307-6KA	6kg	0.1g	5g	1g	6000	m≤5kg: ±0.5g; m>5kg: ±1g
8307-15KA	15kg	0.2g	10g	1g	15000	m≤5kg: ±0.5g; m>5kg: ±1g
8307-30KA	30kg	0.5g	25g	1g	30000	m≤5kg: ±0.5g; 5kg<m≤20kg: ±1g; m>20kg: ±1.5g
8307-3KB	3kg	0.1g	2g	1g	3000	m≤500g: ±0.5g; 500g<m≤2kg: ±1g; m>2kg: ±1.5g
8307-6KB	6kg	0.2g	10g	1g	6000	m≤5kg: ±0.5g; m>5kg: ±1g
8307-15KB	15kg	0.5g	25g	1g	15000	m≤5kg: ±0.5g; m>5kg: ±1g
8307-30KB	30kg	1g	20g	10g	3000	m≤5kg: ±5g; 5kg<m≤20kg: ±10g; m>20kg: ±15g

OPTIONAL ACCESSORY

Alarm light	8001-ALARM
Printer	8001-PRINTER
Data output cable (keyboard format)	7302-8001 page 22
Wireless transmitter (receiver is needed)	7315-8001 page 8

INDUSTRIAL ELECTRONIC BALANCES

DATA
OUTPUT



37

- Double weighing pan in stainless steel and plastic
- Automatic calibration, zero tracking, weighing, counting, taring
- Aluminium alloy base
- Strain balance sensor
- Data output
- Unit: kg, lb



8308-30KB

SPECIFICATION

Operation temperature	0~40°C
Operation humidity	≤80%RH
Dimension of pan	300×224mm
Power supply	rechargeable lead acid battery (6V/4Ah)
Output	RS232

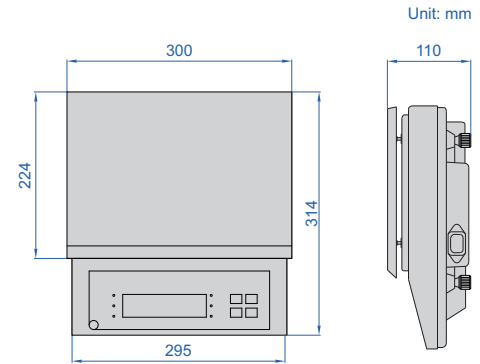

Code	Maximum weighing	Resolution (d)	Minimum weighing	Verification interval (e)	Number of verification interval (n)	Accuracy (m is load)
8308-3K	3kg	0.1g	2g	1g	3000	m≤500g: ±0.5g; 500g<m≤2kg: ±1g; m>2kg: ±1.5g
8308-6K	6kg	0.1g	2g	1g	6000	m≤500g: ±0.5g; 500g<m≤2kg: ±1g; m>2kg: ±1.5g
8308-10K	10kg	1g	20g	10g	1000	m≤5kg: ±5g; m>5kg: ±10g
8308-15K	15kg	0.5g	25g	1g	15000	m≤5kg: ±0.5g; m>5kg: ±1g
8308-20K	20kg	1g	20g	10g	2000	m≤5kg: ±5g; m>5kg: ±10g
8308-30K	30kg	1g	20g	10g	3000	m≤5kg: ±5g; 5kg<m≤20kg: ±10g; m>20kg: ±15g
8308-3KA	3kg	0.5g	10g	1g	3000	m≤500g: ±0.5g; 500g<m≤2kg: ±1g; m>2kg: ±1.5g
8308-6KA	6kg	0.5g	10g	1g	6000	m≤500g: ±0.5g; 500g<m≤2kg: ±1g; m>2kg: ±1.5g
8308-15KA	15kg	1g	20g	10g	1500	m≤5kg: ±5g; m>5kg: ±10g
8308-30KA	30kg	5g	100g	10g	3000	m≤5kg: ±5g; 5kg<m≤20kg: ±10g; m>20kg: ±15g
8308-10KB	10kg	0.1g	5g	1g	10000	m≤5kg: ±0.5g; m>5kg: ±1g
8308-20KB	20kg	0.1g	5g	1g	15000	m≤5kg: ±0.5g; m>5kg: ±1g
8308-30KB	30kg	0.1g	5g	1g	30000	m≤5kg: ±0.5g; 5kg<m≤20kg: ±1g; m>20kg: ±1.5g

OPTIONAL ACCESSORY

RS232 cable	8301-CABLE*
Printer	8303-PRINTER
Data output cable (keyboard format)	7302-8001 page 22
Wireless transmitter (receiver is needed)	7315-8301 page 8

*Used to connect with computers



printer (optional)

CAN BE
CUSTOMIZED

TOUCH
SCREEN

HIGH
ACCURACY

DATA
OUTPUT



INDUSTRIAL ELECTRONIC BALANCES (ADVANCED TYPE)

37



8309-35



printer (optional)



charge pal (optional)

Unit: mm

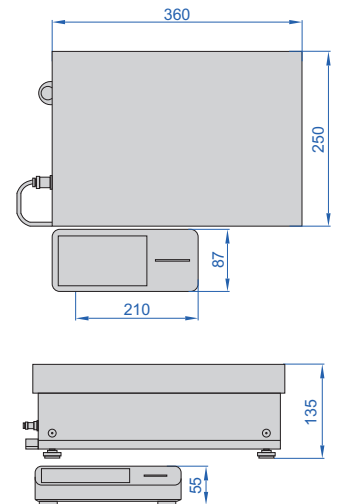

- Electromagnetic balanced sensor
- Compensates for zero stability and weighing accuracy by loading accurately at multiple temperature points
- Stainless steel weighing pan, acid and corrosion resistant
- Manual screen off, screen saver
- Weighing, counting, taring
- Overload alarm
- Unit: g, kg, lb, ct, oz
- Password protection
- Data output

SPECIFICATION

Code	8309-16	8309-20	8309-30	8309-35	8309-16A	8309-20A	8309-30A	8309-35A
Maximum weighing	16kg	20kg	30kg	35kg	16kg	20kg	30kg	35kg
Resolution (d)	0.1g				0.05g			
Verification interval (e)	1g				0.1g			
Accuracy	±0.1g		±0.2g		±0.05g		±0.1g	
Repeatability	±0.1g				±0.05g			
Linearity	±0.1g				±0.05g			
Weight of calibration	10kg		20kg		10kg		20kg	
Calibration method	external calibration							
Minimum weighing	5g							
Stabilization time	≤1.5s							
Operation temperature	10~30°C							
Operation humidity	30%~80%RH							
Weighing pan size	360×250mm							
Power supply	power adapter (5V/2A)							
Data interface	DB9, Type-C, RS485							
Communication protocols	compatible with SBI (RS232) and SICS communication protocols							

To be continued

Continued from previous page

weighing test interface

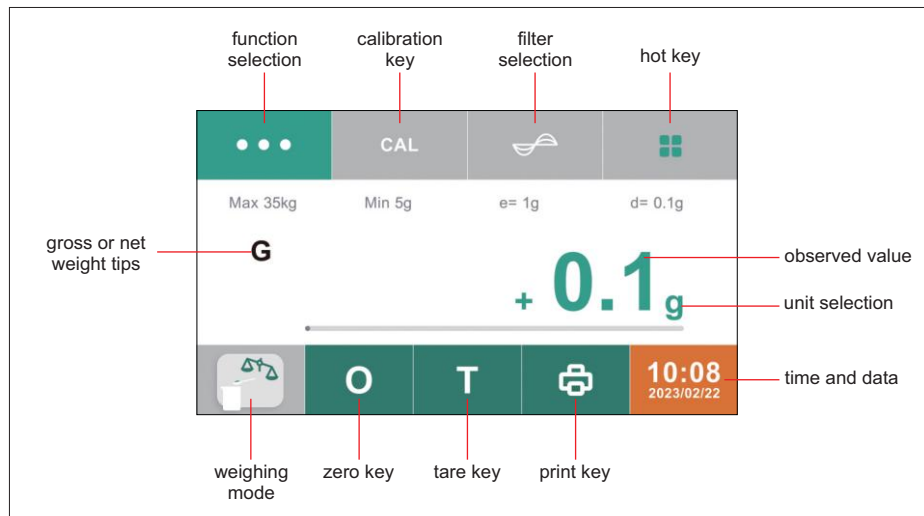

Measurement functions:

<p>Weighing</p> <p>This application determines the weight of the object to be weighed within the specific weighing range of the device</p>	<p>Transition</p> <p>The application can multiply the weighing value with a customizable coefficient to obtain a converted measurement, the last entered coefficient is saved when the power supply is interrupted</p>
<p>Mixing</p> <p>The application allows up to 99 ingredients for a mixture or recipe to be placed sequentially in a container. After each placement of an ingredient, the balance will automatically tare the weight and can display the individual or total weight of the ingredients</p>	<p>Animal weighing</p> <p>The application is suitable for moving weights (e.g. live animals) and for weighing in unstable environments, where a measuring cycle with a defined number of measurements is performed automatically for each object to be weighed, the average value is determined from the individual measurements and displayed as a result</p>
<p>Statistic</p> <p>The application can save up to 99 weighing values and calculated values, and perform statistical evaluations</p>	<p>Check weighing</p> <p>The application checks that the weighing value is within the specified upper and lower limits and determines the test result, allowing weighing of a specific rated weight</p>
<p>Component</p> <p>The application can sum up to 99 weighing values, can weigh components in different containers, and can tare each container before weighing each component</p>	<p>Peak holding</p> <p>This application determines the maximum weighing value (peak value) of a sample and displays the value for up to 5 seconds after the balance has been unloaded</p>
<p>Density</p> <p>The application can determine the density of solid materials based on the buoyancy method (powder density cannot be tested, no density components are supplied as standard)</p>	<p>Counting</p> <p>The application counts almost identical piece weights by comparing them to a reference sample</p>
<p>Percentage</p> <p>This application allows the determination of the percentage or percentage difference of the weighed object based on a reference weight</p>	

STANDARD DELIVERY

Main unit	1 pc
RS232 cable*	1 pc
Touch screen indicator	1 pc

* Used to connect computers

OPTIONAL ACCESSORY

Printer	8309-PRINTER
Charge pal	1155-5-POB

ELECTRONIC DENSITY BALANCES



DATA
OUTPUT

density accessories (included)

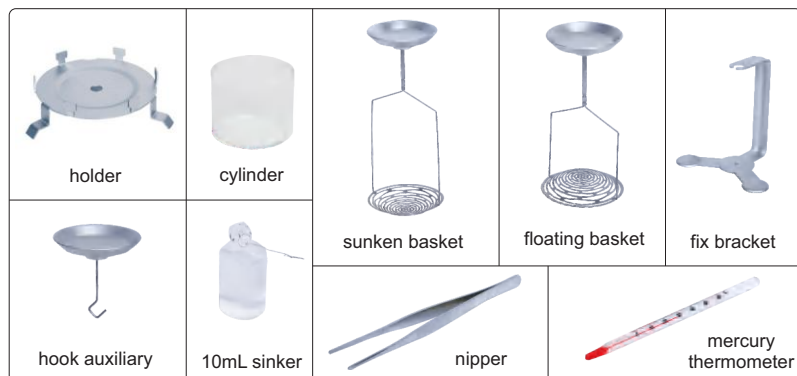

8102-320

- Suitable for measuring the density of solids and liquids
- Aluminium alloy shell, wind shield, three side glass sliding doors
- With a hook at the bottom
- Weighing, counting, taring, percentage display
- Built-in calibration weights, automatic internal calibration
- Unit: g, ct, ozt, oz, gn, dwt, mg
- Electromagnetic balanced sensor
- Large touchscreen display
- Data output



class F1 calibration weight (included)



printer (optional)

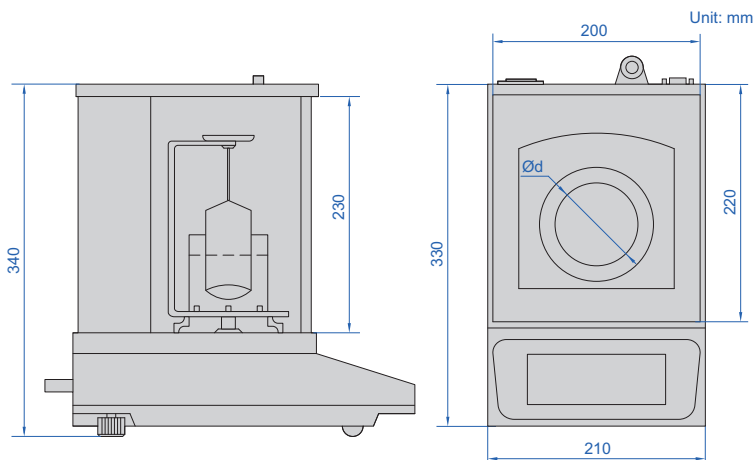

SPECIFICATION

Code	8102-220	8102-320	8102-520	8102-620	8102-1020	8102-1520
Maximum weighing	220g	320g	520g	620g	1020g	1520g
Minimum weighing	20mg	20mg	100mg	100mg	100mg	100mg
Resolution (d)	1mg	1mg	1mg	1mg	1mg	1mg
Verification interval (e)	10mg	10mg	10mg	10mg	10mg	10mg
Accuracy (m is load)	m≤50g: ±5mg; 50g<m≤200g: ±10mg; m>200g: ±15mg		m≤500g: ±5mg; m>500g: ±10mg			
Weighing pan size (Ød)	Ø80mm				Ø120mm	
Operation temperature	15~30°C		18~23°C			
Operation humidity	40%~80%RH		50%~70%RH			
Power supply	220V, 50/60Hz					
Dimension (L×W×H)	330×210×340mm					

OPTIONAL ACCESSORY

RS232 cable	8301-CABLE*
Printer	8303-PRINTER
Data output cable (keyboard format)	7302-8001 page 22
Wireless transmitter (receiver is needed)	7315-8301 page 8
Infrared and penetration thermometer	0321-IT42

* Used to connect computers

STANDARD DELIVERY

Main unit	1 pc
Calibration weight	1 pc
Density accessories	1 set

ELECTRONIC DENSITY BALANCES

DATA
OUTPUT



density accessories (included)

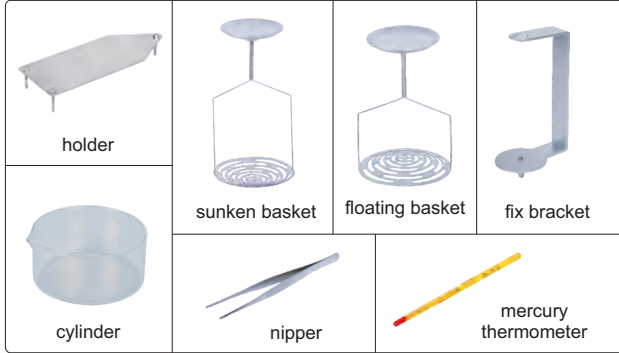

8103-120

- Suitable for measuring the density of solids and liquids
- Transparent glass windshield, bottom with lower weighing hooks
- Weighing, counting, taring, percentage display
- Unit: ct, oz, g, lb
- Rear electromagnetic sensor
- LCD display, with backlight
- Highly accurate and sensitive temperature and humidity sensors reduce the effect of ambient humidity and the sensitivity to temperature changes
- Separated display unit and weighing unit, reduce vibration error
- Data output



class F1 calibration weight (included)



printer (optional)

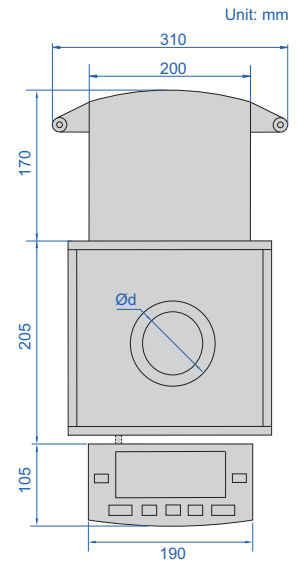
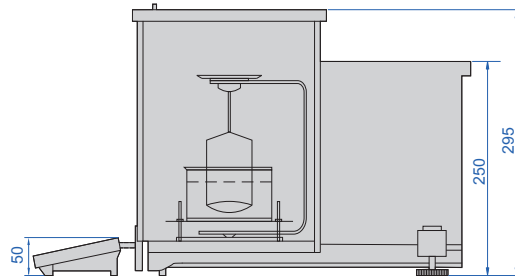

SPECIFICATION

Code	8103-120	8103-210
Maximum weighing	120g	210g
Minimum weighing	10mg	10mg
Resolution (d)	0.1mg	0.1mg
Verification interval (e)	1mg	1mg
Accuracy (m is load)	m≤50g: ±0.5mg; m>50g: ±1mg	m≤50g: ±0.5mg; 50g<m≤200g: ±1mg; m>200g: ±1.5mg
Sample weight	>10g	
Weighing pan size (Ød)	Ø90mm	
Repeatability	±0.1mg	
Linearity	±0.2mg	
Stabilization time	2.5s	
Operation temperature	13~25°C	
Operation humidity	40~80%RH	
Output	RS232	
Power supply	power adapter (12V/2A)	
Dimension (LxWxH)	480×310×320mm	

STANDARD DELIVERY

Main unit	1 pc
Calibration weight	1 pc
Density accessories	1 set

OPTIONAL ACCESSORY

RS232 cable	8301-CABLE*
Printer	8303-PRINTER
Infrared and penetration thermometer	0321-IT42

* Used to connect computers



8106-30KG

Unit: mm

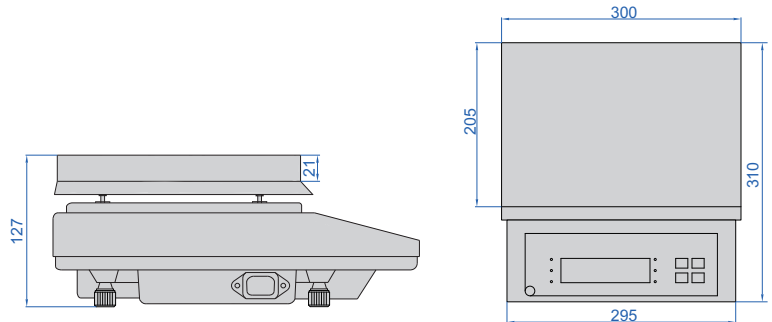

- Automatic calibration, zero tracking, weighing, counting, taring
- Aluminium alloy base, wooden pallet
- Data output
- Strain balance Sensor
- Unit: kg, lb

SPECIFICATION

Code	8106-3KG	8106-6KG	8106-10KG	8106-20KG	8106-30KG
Maximum weighing	3kg	6kg	10kg	20kg	30kg
Minimum weighing	2g	2g	20g	20g	20g
Resolution (d)	0.1g	0.1g	1g	1g	1g
Verification interval (e)	1g	1g	10g	10g	10g
Accuracy (m is load)	m≤500g: ±0.5g; 500g<m≤2kg: ±1g; m>2kg: ±1.5g		m≤5kg: ±5g; m>5kg: ±10g		m≤5kg: ±5g; 5kg<m≤20kg: ±10g m>20kg: ±15g
Operation temperature	0~40°C				
Operation humidity	≤80%RH				
Power supply	220V, 50/60Hz				
Dimension of pan	205×300mm				

OPTIONAL ACCESSORY

RS232 cable	8301-CABLE*
Printer	8303-PRINTER
Data output cable (keyboard format)	7302-8001 page 22
Wireless transmitter (receiver is needed)	7315-8301 page 8

*Used to connect with computers



printer (optional)

MOISTURE ANALYZERS

DATA
OUTPUT



37



calibration weight
(included)



8701-RM40

- LCD screen
- High sensitivity temperature and humidity sensor
- Ring halogen lamp heating evenly, shorten drying time

SPECIFICATION

Code	8701-RM20	8701-RM30	8701-RM40
Maximum weighing	120g	120g	120g
Resolution (d)	5mg	1mg	0.1mg
Accuracy for moisture	sample<10g	±10%	±0.5%
	sample≥10g	±5%	±0.3%
Operation temperature	13~25°C		
Verification interval	2.5s		
Warm-up time	20~30 minutes		
Weighing pan size	Ø90mm		
Heating source	halogen lamp (450W)		
Range for heating temperature	60~200°C		
Heating time setting	0~99 minutes		
Heating mode	standard heating, step heating, rapid heating		
Shutdown mode	automatic shutdown, manual shutdown, timed shutdown		
Output	RS232C		
Power supply	220V, 50/60Hz		
Dimension (L×W×H)	330×210×340mm		

STANDARD DELIEVERY

Main unit	1 pc
Weight	1 pc

OPTIONAL ACCESSORY

RS232 cable	8304-CABLE *
Printer	8303-PRINTER

*Used to connect with computers



WEIGHING SCALES (OIML CERTIFICATE)

- LCD display, with backlight
- Zero-setting, subtracting tare value
- Overload alarm
- Automatic power off
- OIML certificate (No. 0200-NAWI-04601)



8002-30M

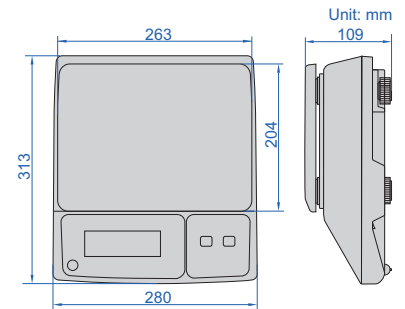

SPECIFICATION

Code	8002-6M	8002-15M	8002-30M	8002-6MD	8002-15MD	8002-30MD
Maximum weighing	3/6kg	6/15kg	15/30kg	3/6kg	6/15kg	15/30kg
Minimum weighing	20g	40g	100g	20g	40g	100g
Resolution (d)	1/2g	2/5g	5/10g	1/2g	2/5g	5/10g
Verification interval (e)	2g	5g	10g	2g	5g	10g
Accuracy (m is load)	m≤3kg: ±1g 3kg<m≤6kg: ±2g	m≤6kg: ±2g 6kg<m≤15kg: ±5g	m≤15kg: ±5g 15kg<m≤30kg: ±10g	m≤3kg: ±1g 3kg<m≤6kg: ±2g	m≤6kg: ±2g 6kg<m≤15kg: ±5g	m≤15kg: ±5g 15kg<m≤30kg: ±10g
Output	no			RS232		
Operation temperature	-10~40°C					
Power supply	rechargeable battery (6V/3.2Ah), power adapter (12V/500mA)					
Dimensions of pan	263×204mm					



printer (optional)

WEIGHING SCALES (HIGH PRECISION)

- LCD display, with backlight
- Zero-setting, subtracting tare value
- Overload alarm
- Automatic power off



8001-30

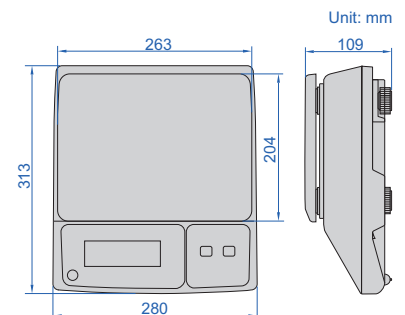

SPECIFICATION

Code	8001-6	8001-15	8001-30	8001-6D	8001-15D	8001-30D
Maximum weighing	6kg	15kg	30kg	6kg	15kg	30kg
Minimum weighing	4g	10g	20g	4g	10g	20g
Resolution (d)	0.2g	0.5g	1g	0.2g	0.5g	1g
Accuracy (m is load)	m≤1kg: ±1g 1kg<m≤4kg: ±2g m>4kg: ±3g	m≤2.5kg: ±2.5g 2.5kg<m≤10kg: ±5g m>10kg: ±7.5g	m≤5kg: ±5g 5kg<m≤20kg: ±10g m>20kg: ±15g	m≤1kg: ±1g 1kg<m≤4kg: ±2g m>4kg: ±3g	m≤2.5kg: ±2.5g 2.5kg<m≤10kg: ±5g m>10kg: ±7.5g	m≤5kg: ±5g 5kg<m≤20kg: ±10g m>20kg: ±15g
Units	kg, lb			kg		
Output	no			RS232		
Operation temperature	-10~40°C					
Power supply	rechargeable lead acid battery (6V/3.2Ah)					
Dimensions of pan	263×204mm					

OPTIONAL ACCESSORY (for scales with RS232)

Printer	8001-PRINTER
Data output cable (keyboard format)	7302-8001 page 22
Wireless transmitter (receiver is needed)	7315-8001 page 8

COUNTING SCALES

37



printer (optional)

- LCD display, with backlight
- Zero-setting, subtracting tare value, counting, accumulation, checking alarm
- Overload alarm
- Units: kg, g, lb, tj, hj, lb-oz



8101-30

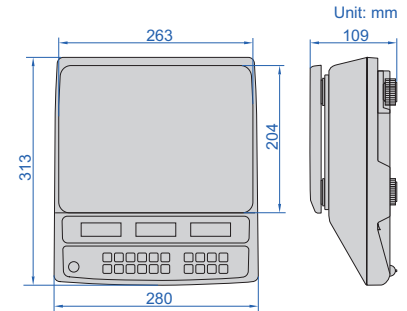

SPECIFICATION

Code	8101-6	8101-15	8101-30	8101-6D	8101-15D	8101-30D
Maximum weighing	6kg	15kg	30kg	6kg	15kg	30kg
Minimum weighing	4g	10g	20g	4g	10g	20g
Resolution (d)	0.2g	0.5g	1g	0.2g	0.5g	1g
Accuracy (m is load)	m≤1kg: ±1g 1kg<m≤4kg: ±2g m>4kg: ±3g	m≤2.5kg: ±2.5g 2.5kg<m≤10kg: ±5g m>10kg: ±7.5g	m≤5kg: ±5g 5kg<m≤20kg: ±10g m>20kg: ±15g	m≤1kg: ±1g 1kg<m≤4kg: ±2g m>4kg: ±3g	m≤2.5kg: ±2.5g 2.5kg<m≤10kg: ±5g m>10kg: ±7.5g	m≤5kg: ±5g 5kg<m≤20kg: ±10g m>20kg: ±15g
Output	no			RS232		
Operation temperature	-10~40°C					
Power supply	rechargeable battery (6V/3.2Ah), power adapter (12V/500mA)					
Dimensions of pan	263×204mm					

OPTIONAL ACCESSORY (for scales with RS232)

Printer	8001-PRINTER
---------	--------------

WEIGHING SCALES (ECONOMIC TYPE)



- Unit: g, oz, lb, tl



8003-3

SPECIFICATION

Code	8003-3	8003-6	8003-10
Maximum weighing	3kg	6kg	10kg
Minimum weighing	2g	10g	20g
Resolution (d)	0.1g	0.5g	1g
Accuracy	±0.5g	±2.5g	±5g
Weighing pan size	157×157mm		
Operation temperature	5~35°C		
Power supply	2×AAA batteries, power adapter		
Dimension (L×W)	160×225mm		

ATTENTION:
LOW ACCURACY

ELECTRONIC POCKET SCALE (ECONOMIC TYPE)

- LCD display, with backlight
- Zero-setting, subtracting tare value, counting
- Overload alarm
- Automatic power off



8602-200

SPECIFICATION

Code	8602-200
Maximum weighing	200g
Minimum weighing	0.2g
Resolution (d)	0.02g
Accuracy (m is load)	0.2g≤m≤2g: ±0.06g; 2g<m≤60g: ±0.1g 60g<m≤100g: ±0.14g; m>100g: ±0.28g
Units	g, oz, dwt, ozt
Dimension of pan	55×64mm
Dimension (L×W×H)	120×70×17mm
Operation temperature	-10~40°C
Power supply	2×CR2032 batteries

use of pan



ATTENTION:
LOW ACCURACY

ELECTRONIC POCKET SCALE (ECONOMIC TYPE)

- LCD display, with backlight
- Zero-setting, subtracting tare value, counting
- Overload alarm
- Automatic power off



8601-100

SPECIFICATION

Code	8601-100
Maximum weighing	100g
Minimum weighing	0.1g
Resolution (d)	0.01g
Accuracy (m is load)	0.1g≤m≤1g: ±0.03g; 1g<m≤30g: ±0.05g 30g<m≤50g: ±0.07g; m>50g: ±0.14g
Units	g, oz, dwt, ozt
Dimension of pan	55×64mm
Dimension (L×W×H)	108×65×21mm
Operation temperature	-10~40°C
Power supply	2×AAA batteries

use of pan



PLATFORM SCALES

DATA
OUTPUT

CAN BE
CUSTOMIZED

37



8501-AL150



printer (optional)

- LCD large screen display with LED backlight
- Weighing, overweight alarm, counting, keyboard lock, accumulating, auto zero and animal scale
- Unit: kg, g, lb, oz

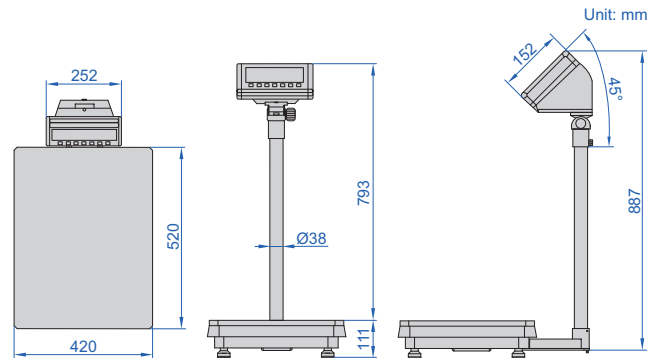

SPECIFICATION

Code	8501-AL60	8501-AL150	8501-AL300
Maximum weighing	60kg	150kg	300kg
Minimum weighing	100g	200g	400g
Resolution (d)	5g	10g	20g
Accuracy	±10g	±20g	±30g
Operation temperature	-10~40°C		
Material	platform: stainless steel, base: die-cast aluminum		
Dimension of platform	420×520mm		
Power supply	rechargeable lead acid battery (6V/4Ah)		
Output	RS232		
Weight	18.3kg		

OPTIONAL ACCESSORY

Printer	8001-PRINTER
Data output cable (keyboard format)	7302-8001 page 22
Wireless transmitter (receiver is needed)	7315-8001 page 8

PARCEL SCALES

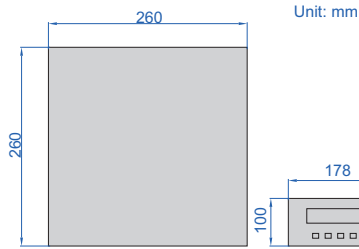

8502-30

- Weighting, counting, subtracting tare value
- LED display, adjustable brightness
- Low voltage indication
- Automatic power off
- Overload indication
- Unit: kg, lb

OPTIONAL ACCESSORY

Cast iron weights	8913
-------------------	------

SPECIFICATION

Code	8502-30	8502-50	8502-60	8502-75
Maximum weighing	30kg	50kg	60kg	75kg
Minimum weighing	2g	20g	20g	20g
Resolution (d)	m≤3kg: 0.1g; 3kg<m≤30kg: 1g	1g	1g	1g
Accuracy (m is load)	m≤3kg: ±0.3g; 3kg<m≤30kg: ±3g	±3g	±3g	±3g
Weight of calibration	20kg	50kg	50kg	50kg
Weighing pan size	260×260mm			
Material	platform: ABS plastic, base: die-cast aluminum			
Operation temperature	5~35°C			
Operation humidity	30%~80%RH			
Power supply	power adapter (6V/300mA) or 4×1.5V AA batteries			

PARCEL SCALES

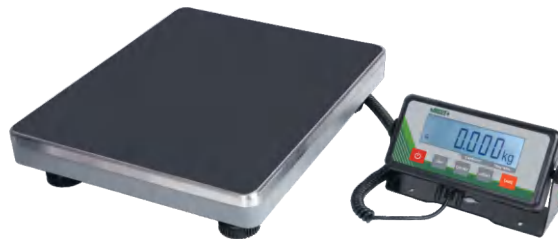
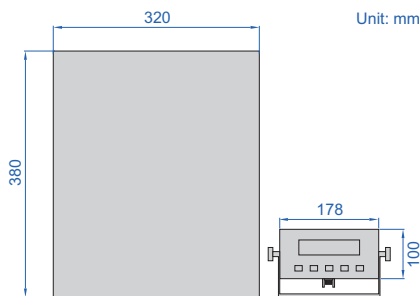

8503-30

- Weighting, counting, subtracting tare value
- LCD display, with backlight
- Overload indication
- Automatic power off
- Low voltage indication
- Unit: kg, lb

OPTIONAL ACCESSORY

Cast iron weights	8913
-------------------	------

SPECIFICATION

Code	8503-30	8503-60	8503-120	8503-200
Maximum weighing	30kg	60kg	120kg	200kg
Minimum weighing	20g	100g	200g	400g
Resolution (d)	1g	5g	10g	20g
Accuracy	±3g	±15g	±30g	±60g
Weight of calibration	20kg	50kg	100kg	200kg
Weighing pan size	320×380mm			
Material	platform: stainless steel, base: die-cast aluminum			
Operation temperature	5~35°C			
Operation humidity	30%~80%RH			
Power supply	power adapter (6V/300mA) or 4×1.5V AA batteries			

FLOOR SCALES

DATA
OUTPUT

37

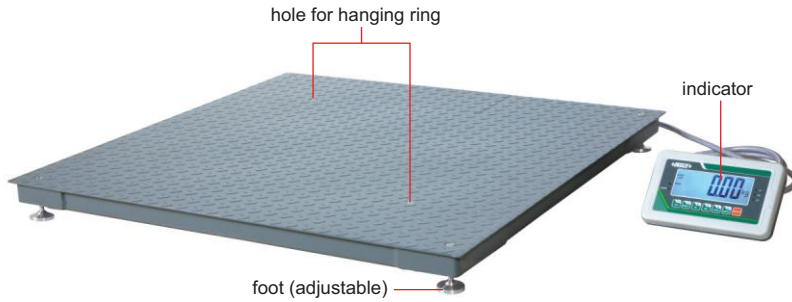

8401-1T1212

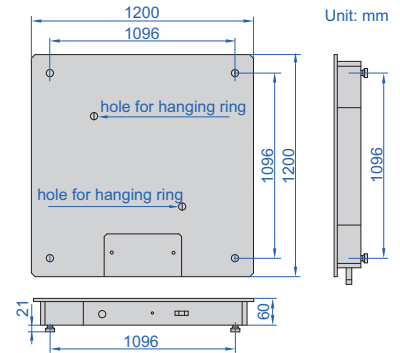

- LCD large screen display with automatic backlight
- Zero, overweight alarm, deduction, unit conversion, accumulating, animal scale, etc.
- Unit: kg, g, lb, oz
- OIML approved load cell

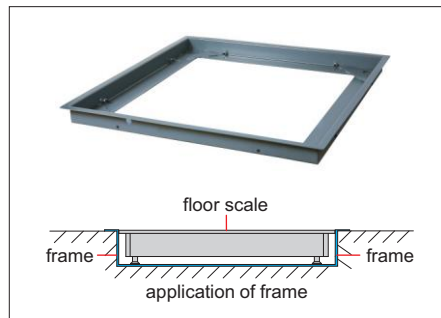

frame (optional)



stand (optional)

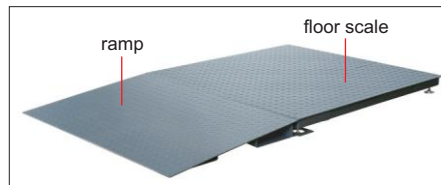

ramp (optional)



printer (optional)

SPECIFICATION

Code	8401-1T1212	8401-2T1212	8401-3T1212
Maximum weighing	1t	2t	3t
Minimum weighing	10kg	20kg	20kg
Resolution (d)	0.5kg	1kg	1kg
Verification interval (e)	0.5kg	1kg	1kg
Accuracy (m is load)	m≤250kg: ±0.25kg; 250kg<m≤1000kg: ±0.5kg	m≤500kg: ±0.5kg; 500kg<m≤2000kg: ±1kg; m>2000kg: ±1.5kg	
Load cell	4 pcs 350Ω		
Operation temperature	-10~40°C		
Material	mild steel		
Dimension of platform	1200×1200mm		
Power supply	rechargeable lead acid battery (6V/4Ah)		
Output	RS232		
Weight	140kg		

STANDARD DELIVERY

Main unit	1 pc
Indicator	1 pc
AC/DC adapter	1 pc
Stainless steel foot	4 pcs
Hanging ring	2 pcs

OPTIONAL ACCESSORY

Ramp	8401-1212-1
Frame	8401-1212-2
Stand	8401-STAND
Printer	8001-PRINTER



LED indicator

8801-A20

- Zero-setting, subtracting tare value, counting, check weighing
- Automatic screen off, automatic power off
- Low voltage indication, overload indication
- Weight hold, weight totalisation, percentage display
- LED large screen display
- Unit: kg, lb

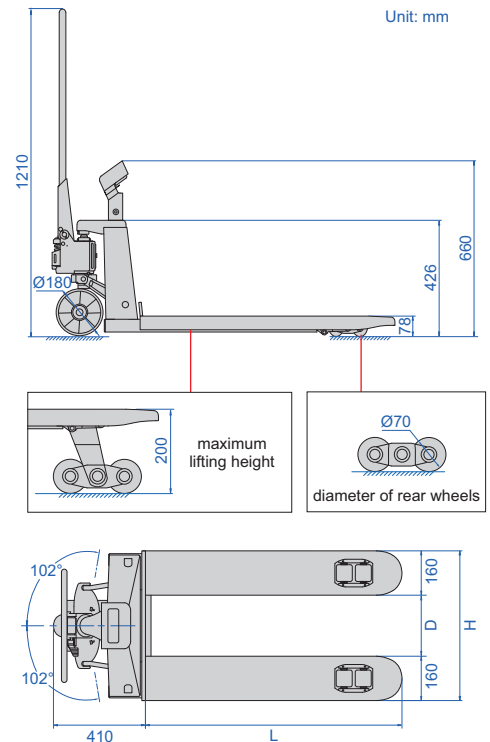

SPECIFICATION

Code	8801-A15	8801-A20	8801-A25	8801-B15	8801-B20	8801-B25
Maximum weighting	1500kg	2000kg	2500kg	1500kg	2000kg	2500kg
Minimum weighting	10kg	20kg	20kg	10kg	20kg	20kg
Resolution	0.5kg	1kg	1kg	0.5kg	1kg	1kg
Accuracy	±1kg	±1kg	±2kg	±1kg	±1kg	±2kg
Forklift arm length (L)	1150mm			1220mm		
Forklift arm distance (D)	220mm			360mm		
Overall forklift width (H)	540mm			680mm		
Weight	98kg			105kg		
Material	mild steel					
Indicator power supply	rechargeable lead acid battery (6V/4Ah)					
Operation temperature	-10~50°C					
Operation humidity	30%~90%RH					
Limited load	2500kg	3000kg	3000kg	2500kg	3000kg	3000kg

DIRECT VIEW ELECTRONIC CRANE SCALES

IP65
WATERPROOF

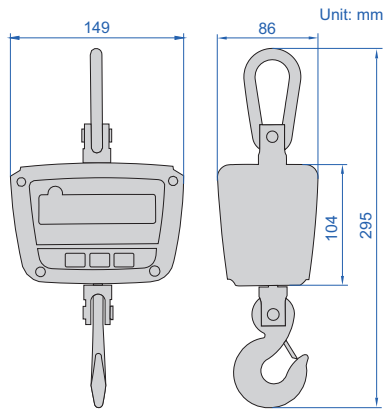
- Dust/waterproof level: IP65
- LED display, remote control
- Low voltage indicator
- Unit: kg, lb
- Automatic power off
- Overload alarm
- 360° safe rotary hook and shackle
- Aluminum alloy die casting case with high strength



SPECIFICATION

Code	8201-50KG	8201-150KG	8201-300KG
Maximum weighing	50kg	150kg	300kg
Minimum weighing	0.4kg	1.0kg	2.0kg
Resolution (d)	0.02kg/0.01kg	0.05kg/0.02kg	0.10kg/0.05kg
Verification interval (e)	0.02kg	0.05kg	0.10kg
Accuracy	±0.02kg	±0.05kg	±0.10kg
Operation temperature	-10~40°C		
Operation humidity	30%~90%RH		
Overload alarm	100%FS+9e		
Maximum safe load	125%FS		
Limited overload	400%FS		
Power supply	rechargeable battery 6V/3Ah (for 40 hours working)		
Stable reading time	≤8s		



remote controller
(included)

8201-150KG

STANDARD DELIVERY

Main unit	1 pc
Remote controller	1 pc
Battery charger	1 pc

DIRECT VIEW ELECTRONIC CRANE SCALES (BASIC TYPE)

- LED display, remote control
- Low voltage indicator
- Unit: kg, lb
- Automatic power off
- Overload alarm
- 360° safe rotary hook and shackle
- Plastic case

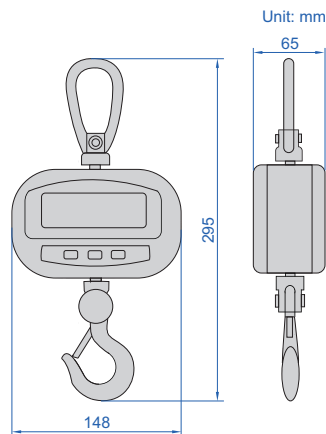

SPECIFICATION

Code	8202-50KG	8202-150KG	8202-300KG
Maximum weighing	50kg	150kg	300kg
Minimum weighing	0.4kg	1.0kg	2.0kg
Resolution (d)	0.02kg/0.01kg	0.05kg/0.02kg	0.10kg/0.05kg
Verification interval (e)	0.02kg	0.05kg	0.10kg
Accuracy	±0.02kg	±0.05kg	±0.10kg
Operation temperature	-10~40°C		
Operation humidity	30%~90%RH		
Overload alarm	100%FS+9e		
Maximum safe load	125%FS		
Limited overload	400%FS		
Power supply	4×1.5V AA batteries (for 40 hours working)		
Stable reading time	≤8s		



remote controller
(included)

8202-150KG

STANDARD DELIVERY

Main unit	1 pc
Remote controller	1 pc

ELECTRONIC CRANE SCALES



- Zeroing, taring, weighing
- LED display, remote control
- Low voltage indicator
- Unit: kg, lb
- Overload alarm
- Automatic power off
- Aluminum alloy die casting case with high strength

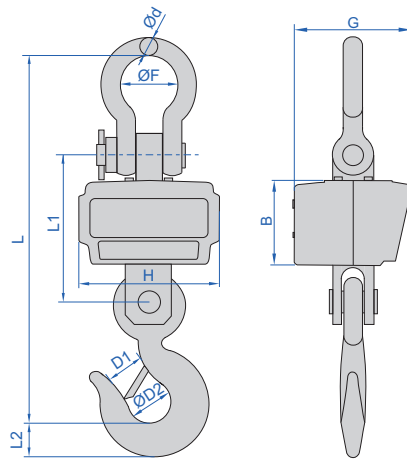

8204-CS3T

remote controller (included)

(mm)

Code	B	G	H	L	L1	L2	D1	ØD2	Ød	ØF
8204-CS06T	120	163	198	420	190	33	40	47	21	76
8204-CS1T	120	163	198	420	190	33	40	47	21	76
8204-CS2T	120	163	198	420	190	33	50	47	21	76
8204-CS3T	120	163	198	462	196	40	50	50	23	76
8204-CS5T	120	163	198	511	204	47	52	60	26	80
8204-CS10T	135	181	206	589	239	66	52	70	36	90
8204-CS15T	135	181	206	727	257	77	60	85	47	135

SPECIFICATION

Overload alarm	100%FS+9e
Maximum safe load	150%FS
Limited overload	400%FS
Stable reading time	≤8s
Power supply	rechargeable battery 6V/4Ah (for 40 hours working)
Operation temperature	-10~40°C
Operation humidity	≤85%RH

Code	8204-CS06T	8204-CS1T	8204-CS2T	8204-CS3T
Maximum weighing	600kg	1000kg	2000kg	3000kg
Minimum weighing	5kg	10kg	20kg	30kg
Resolution (d)	0.2kg/0.1kg	0.5kg/0.2kg	1kg/0.5kg	1kg/0.5kg
Verification interval (e)	0.2kg	0.5kg	1kg	1kg
Accuracy (m is load)	m≤100kg: ±0.1kg; 50kg<m≤200kg: ±0.2kg; m>200kg: ±0.3kg	m≤250kg: ±0.25kg; 250kg<m≤1000kg: ±0.5kg	m≤500kg: ±0.5kg; 500kg<m≤2000kg: ±1kg	m≤500kg: ±0.5kg; 500kg<m≤2000kg: ±1kg; m>2000kg: ±1.5kg

Code	8204-CS5T	8204-CS10T	8204-CS15T
Maximum weighing	5000kg	10000kg	15000kg
Minimum weighing	50kg	100kg	100kg
Resolution (d)	2kg/1kg	5kg/2kg	5kg/2kg
Verification interval (e)	2kg	5kg	5kg
Accuracy (m is load)	m≤1000kg: ±1kg; 1000kg<m≤4000kg: ±2kg; m>4000kg: ±3kg	m≤2500kg: ±2.5kg; 2500kg<m≤10000kg: ±5kg	m≤2500kg: ±2.5kg; 2500kg<m≤10000kg: ±5kg; m>10000kg: ±7.5kg

To be continued

Continued from previous page

37

STANDARD DELIVERY

Main unit	1 pc
Remote controller	1 pc
Battery charger	1 pc



handheld display (optional)



large display (optional)

OPTIONAL ACCESSORY

Handheld display	8204-INDICATOR (must be supplied with scales together)
Large display	8204-SCREEN (must be supplied with scales together)

ELECTRONIC CRANE SCALES (BASIC TYPE)



- Zeroing, taring, weighing
- LED display, remote control
- Low voltage indicator
- Unit: kg, lb
- Overload alarm
- Automatic power off
- Aluminum alloy die casting case with high strength



8203-CW05T



remote controller (included)

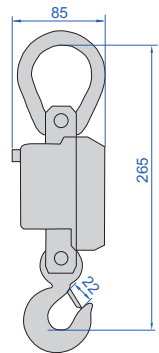
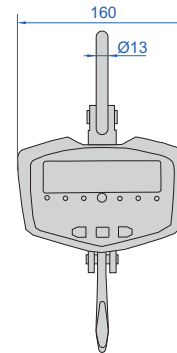

Unit: mm

SPECIFICATION

Code	8203-CW03T	8203-CW05T	8203-CW1T
Maximum weighing	300kg	500kg	1000kg
Minimum weighing	2kg	4kg	10kg
Resolution (d)	0.1kg/0.05kg	0.2kg/0.1kg	0.5kg/0.2kg
Verification interval (e)	0.1kg	0.2kg	0.5kg
Accuracy (m is load)	m≤50kg: ±0.05kg; 50kg<m≤200kg: ±0.1kg; m>200kg: ±0.15kg	m≤100kg: ±0.1kg; 100kg<m≤400kg: ±0.2kg; m>400kg: ±0.3kg	m≤250kg: ±0.25kg; 250kg<m≤1000kg: ±0.5kg
Overload alarm	100%FS+9e		
Maximum safe load	150%FS		
Limited overload	400%FS		
Stable reading time	≤8s		
Power supply	3×1.5V AA batteries		
Operation temperature	-10~40°C		
Operation humidity	30%~90%RH		

STANDARD DELIVERY

Main unit	1 pc
Remote controller	1 pc

WIRELESS ELECTRONIC CRANE SCALES



IP65
WATERPROOF

37

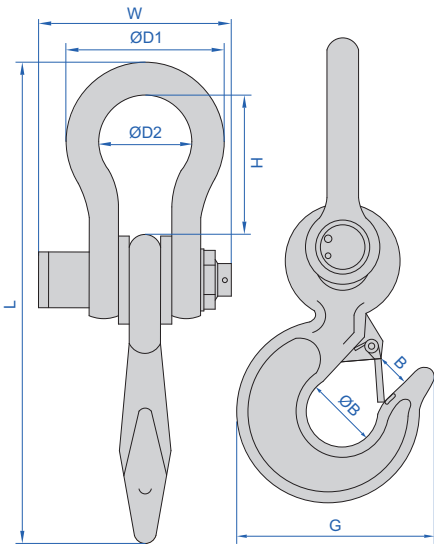

remote controller
(included)



8205-3T



wireless printer (optional)



large display (optional)

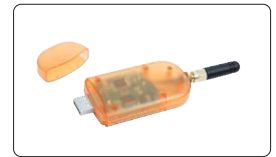

wireless receiver (optional)

- Wireless zero-setting, subtracting tare value, totalization
- Remote reading
- Wireless transmission distance up to 100 meters
- Low voltage indication, overload alarm
- Unit: kg, lb
- Automatic power off

SPECIFICATION

Overload alarm	100%FS+9e
Maximum safe load	150%FS
Limited overload	400%FS
Stable reading time	≤8s
Power supply	rechargeable battery 4.2V/1A (for 40 hours working)
Operation temperature	-10~40°C
Operation humidity	≤85%RH

Code	L	H	ØD1	ØD2	W	G	B	ØB
8205-2T	319	88	132	72	198	126	34	48
8205-3T	319	88	132	72	198	126	34	48
8205-5T	407	105	160	88	219	161	42	57
8205-10T	465	105	170	95	246	202	46	65
8205-15T	520	130	215	120	263	203	60	77
8205-20T	621	135	251	142	294	284	75	105
8205-30T	770	205	325	180	356	305	85	125
8205-50T	1020	340	360	200	436	470	135	170

(mm)

Code	8205-2T	8205-3T	8205-5T	8205-10T
Maximum weighing	2t	3t	5t	10t
Minimum weighing	10kg	20kg	40kg	100kg
Resolution (d)	1kg/0.5kg	1kg/0.5kg	2kg/1kg	5kg
Accuracy (m is load)	m≤0.5t: ±0.5kg; m>0.5t: ±1kg	m≤0.5t: ±0.5kg; 0.5t<m≤2t: ±1kg; m>2t: ±1.5kg	m≤1t: ±1kg; 1t<m≤4t: ±2kg; m>4t: ±3kg	m≤2.5t: ±2.5kg; m>2.5t: ±5kg

Code	8205-15T	8205-20T	8205-30T	8205-50T
Maximum weighing	15t	20t	30t	50t
Minimum weighing	100kg	200kg	200kg	400kg
Resolution (d)	5kg	10kg	10kg	20kg
Accuracy (m is load)	m≤2.5t: ±2.5kg; 2.5t<m≤10t: ±5kg; m>10t: ±7.5kg	m≤5t: ±5kg; m>5t: ±10kg	m≤5t: ±5kg; 5t<m≤20t: ±10kg; m>20t: ±15kg	m≤10t: ±10kg; 10t<m≤40t: ±20kg; m>40t: ±30kg

To be continued

Continued from previous page

STANDARD DELIVERY

Main unit	1 pc
Remote controller	1 pc

OPTIONAL ACCESSORY

Wireless printer	8205-PRINTER (must be supplied with scales together)
Large display	8205-SCREEN (must be supplied with scales together)
Wireless receiver (serial port signal, connect to computers)	8205-RECEIVER (must be supplied with scales together)

37

HANG SCALES

CAN BE CUSTOMIZED



hang scale pull rings (optional)

- Unit: kg, N
- LED display, remote control
- Zeroing, taring, weighing, totalization
- Peak (max.) and tracking mode
- Low voltage indicator
- Built-in buzzer
- Automatic power off
- Overload alarm



remote controller (included)



8206-3T

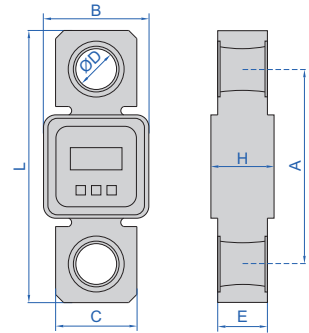

SPECIFICATION

Operation temperature	-10~55°C
Operation humidity	≤85%RH
Material	alloy steel
Power supply	3×1.5V AA batteries
Stable reading time	≤8s
Limited overload	300%FS
Maximum safe load	150%FS
Overload alarm	100%FS+9e

Code	Dimension (mm)						
	L	B	C	H	E	A	ØD
8206-05T	204	99	46	50	30	158	26
8206-1T	204	99	46	50	30	158	26
8206-2T	204	99	46	50	30	158	26
8206-3T	204	99	46	54	30	158	26
8206-5T	222	99	60	58	35	162	31
8206-10T	268	104	80	62	49	192	41
8206-15T	304	110	92	66	58	212	46.5
8206-20T	344	120	120	66	66	232	56.5
8206-30T	394	132	132	73	73	264	66
8206-50T	500	150	150	100	100	340	80

Code	Maximum weighing		Minimum weighing		Resolution (d)		Verification interval (e)	Accuracy		Weight
	mass values	force values	mass values	force values	mass values	force values		mass values	force values	
8206-05T	0.5t	5kN	4kg	40N	0.2kg/0.1kg	2N/1N	0.2kg	±0.2kg	±1%	1.6kg
8206-1T	1t	10kN	10kg	100N	0.5kg/0.2kg	5N/2N	0.5kg	±0.5kg		2kg
8206-2T	2t	20kN	20kg	200N	1kg/0.5kg	10N/5N	1kg	±1kg		2.1kg
8206-3T	3t	30kN	20kg	200N	1kg/0.5kg	10N/5N	1kg	±1.5kg		2.3kg
8206-5T	5t	50kN	40kg	400N	2kg/1kg	20N/10N	2kg	±2kg		3.6kg
8206-10T	10t	100kN	100kg	1kN	5kg/2kg	50N/20N	5kg	±5kg		6.2kg
8206-15T	15t	150kN	100kg	1kN	5kg/2kg	50N/20N	5kg	±7.5kg		9.5kg
8206-20T	20t	200kN	200kg	2kN	10kg/5kg	100N/50N	10kg	±10kg		15kg
8206-30T	30t	300kN	200kg	2kN	10kg/5kg	100N/50N	10kg	±15kg		21.9kg
8206-50T	50t	500kN	400kg	4kN	20kg/10kg	200N/100N	20kg	±20kg		45.5kg

STANDARD DELIVERY

Main unit	1 pc
Remote controller	1 pc

OPTIONAL ACCESSORY

Hang scale pull rings	page 1181
-----------------------	-----------

CAN BE CUSTOMIZED

WIRELESS HANG SCALES



hang scale pull rings (optional)



8207-3T



LCD remote controller (included)

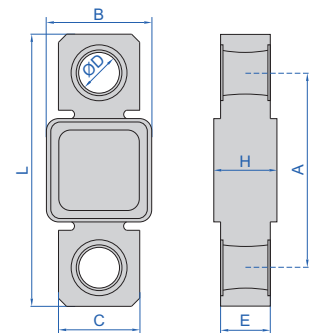

- Unit: kg, N
- LCD handheld display, remote control
- Wireless zero-setting, subtracting tare value, totalization
- Peak (max.) and tracking mode
- Wireless transmission distance up to 100 meters
- Low voltage indicator
- Built-in buzzer
- Automatic power off
- Overload alarm

SPECIFICATION

Operation temperature	-10~55°C
Operation humidity	≤85%RH
Material	alloy steel
Power supply	3×1.5V AA batteries
Stable reading time	≤8s
Limited overload	300%FS
Maximum safe load	150%FS
Overload alarm	100%FS+9e

Code	Dimension (mm)						
	L	B	C	H	E	A	ØD
8207-05T	204	99	46	50	30	158	26
8207-1T	204	99	46	50	30	158	26
8207-2T	204	99	46	50	30	158	26
8207-3T	204	99	46	54	30	158	26
8207-5T	222	99	60	58	35	162	31
8207-10T	268	104	80	62	49	192	41
8207-15T	304	110	92	66	58	212	46.5
8207-20T	344	120	120	66	66	232	56.5
8207-30T	394	132	132	73	73	264	66
8207-50T	500	150	150	100	100	340	80

Code	Maximum weighing		Minimum weighing		Resolution (d)		Verification interval (e)	Accuracy		Weight
	mass values	force values	mass values	force values	mass values	force values		mass values	force values	
8207-05T	0.5t	5kN	4kg	40N	0.2kg/0.1kg	2N/1N	0.2kg	±0.2kg	±1%	1.6kg
8207-1T	1t	10kN	10kg	100N	0.5kg/0.2kg	5N/2N	0.5kg	±0.5kg		2kg
8207-2T	2t	20kN	20kg	200N	1kg/0.5kg	10N/5N	1kg	±1kg		2.1kg
8207-3T	3t	30kN	20kg	200N	1kg/0.5kg	10N/5N	1kg	±1.5kg		2.3kg
8207-5T	5t	50kN	40kg	400N	2kg/1kg	20N/10N	2kg	±2kg		3.6kg
8207-10T	10t	100kN	100kg	1kN	5kg/2kg	50N/20N	5kg	±5kg		6.2kg
8207-15T	15t	150kN	100kg	1kN	5kg/2kg	50N/20N	5kg	±7.5kg		9.5kg
8207-20T	20t	200kN	200kg	2kN	10kg/5kg	100N/50N	10kg	±10kg		15kg
8207-30T	30t	300kN	200kg	2kN	10kg/5kg	100N/50N	10kg	±15kg		21.9kg
8207-50T	50t	500kN	400kg	4kN	20kg/10kg	200N/100N	20kg	±20kg		45.5kg

STANDARD DELIVERY

Main unit	1 pc
LCD remote controller	1 pc

OPTIONAL ACCESSORY

Hang scale pull rings	page 1181
-----------------------	-----------

HANG SCALE PULL RINGS

- Used with 8206 series and 8207 series hang scales



8290-1

application

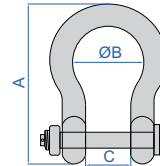

SPECIFICATION

Code	Material	Dimension (mm)			Adapted products
		A	ØB	C	
8290-1	alloy steel	76	169	107	8207-05T, 8207-1T, 8207-2T, 8207-3T, 8206-05T, 8206-1T, 8206-2T, 8206-3T
8290-2		80	192	122	8206-5T, 8207-5T
8290-3		90	241	145	8206-10T, 8207-10T
8290-4		135	318	202	8206-15T, 8207-15T
8290-5		150	355	220	8206-20T, 8207-20T
8290-6		150	448	279	8206-30T, 8207-30T
8290-7		214	504	313	8206-50T, 8207-50T

STANDARD DELIVERY

Main unit 1 pair

PORTABLE CRANE SCALE CODE 8604-40

ATTENTION:
LOW ACCURACY

- Zero-setting, subtracting tare value
- Automatic power off
- LCD display, with backlight
- Unit: kg
- Overload indication

SPECIFICATION

Maximum weighing	40kg
Minimum weighing	1kg
Resolution (d)	50g
Accuracy	±50g
Operation temperature	-10~45°C
Operation humidity	30%~90%RH
Limited load	50kg
Power supply	2×AAA batteries



built-in measuring tape
(included)

TUBE FORCE GAUGES

REFER TO PAGE 981
FOR DETAILS



8603-100



1kg 200g 500mg 200mg 100mg

- Supplied with manufacturer inspection certificate

CLASS SELECTION

Resolution of the weighing instruments	Required class of weights
0.001mg	E1
0.01mg	E2
0.1mg	E2/F1
1mg	F2
0.01g/0.1g	M1

OIML R111-2004 TOLERANCE

Weight	E2	F1	F2	M1
1mg	0.006mg	0.020mg	0.06mg	0.20mg
2mg	0.006mg	0.020mg	0.06mg	0.20mg
5mg	0.006mg	0.020mg	0.06mg	0.20mg
10mg	0.008mg	0.025mg	0.08mg	0.25mg
20mg	0.010mg	0.03mg	0.10mg	0.3mg
50mg	0.012mg	0.04mg	0.12mg	0.4mg
100mg	0.016mg	0.05mg	0.16mg	0.5mg
200mg	0.020mg	0.06mg	0.20mg	0.6mg
500mg	0.025mg	0.08mg	0.25mg	0.8mg
1g	0.03mg	0.10mg	0.3mg	1.0mg
2g	0.04mg	0.12mg	0.4mg	1.2mg
5g	0.05mg	0.16mg	0.5mg	1.6mg
10g	0.06mg	0.20mg	0.6mg	2.0mg
20g	0.08mg	0.25mg	0.8mg	2.5mg
50g	0.10mg	0.3mg	1.0mg	3.0mg
100g	0.16mg	0.5mg	1.6mg	5.0mg
200g	0.3mg	1.0mg	3.0mg	10mg
500g	0.8mg	2.5mg	8.0mg	25mg
1kg	1.6mg	5.0mg	16mg	50mg
2kg	3.0mg	10mg	30mg	100mg
5kg	8.0mg	25mg	80mg	250mg
10kg	16mg	50mg	160mg	500mg
20kg	30mg	100mg	300mg	1000mg

Weight	Class and material						Shape
	E2 (non-magnetic stainless steel)	F1 (non-magnetic stainless steel)	F1 (304 stainless steel)	F2 (304 stainless steel)	M1 (304 stainless steel)	M1 (2Cr13 stainless steel)	
1mg	8911-1MGE2	8911-1MGF1	8911-1MGF1S	8911-1MGF2	8911-1MGM1	8911-1MGM1C	sheet
2mg	8911-2MGE2	8911-2MGF1	8911-2MGF1S	8911-2MGF2	8911-2MGM1	8911-2MGM1C	
5mg	8911-5MGE2	8911-5MGF1	8911-5MGF1S	8911-5MGF2	8911-5MGM1	8911-5MGM1C	
10mg	8911-10MGE2	8911-10MGF1	8911-10MGF1S	8911-10MGF2	8911-10MGM1	8911-10MGM1C	
20mg	8911-20MGE2	8911-20MGF1	8911-20MGF1S	8911-20MGF2	8911-20MGM1	8911-20MGM1C	
50mg	8911-50MGE2	8911-50MGF1	8911-50MGF1S	8911-50MGF2	8911-50MGM1	8911-50MGM1C	
100mg	8911-100MGE2	8911-100MGF1	8911-100MGF1S	8911-100MGF2	8911-100MGM1	8911-100MGM1C	
200mg	8911-200MGE2	8911-200MGF1	8911-200MGF1S	8911-200MGF2	8911-200MGM1	8911-200MGM1C	
500mg	8911-500MGE2	8911-500MGF1	8911-500MGF1S	8911-500MGF2	8911-500MGM1	8911-500MGM1C	
1g	8911-1GE2	8911-1GF1	8911-1GF1S	8911-1GF2	8911-1GM1	8911-1GM1C	cylinder
2g	8911-2GE2	8911-2GF1	8911-2GF1S	8911-2GF2	8911-2GM1	8911-2GM1C	
5g	8911-5GE2	8911-5GF1	8911-5GF1S	8911-5GF2	8911-5GM1	8911-5GM1C	
10g	8911-10GE2	8911-10GF1	8911-10GF1S	8911-10GF2	8911-10GM1	8911-10GM1C	
20g	8911-20GE2	8911-20GF1	8911-20GF1S	8911-20GF2	8911-20GM1	8911-20GM1C	
50g	8911-50GE2	8911-50GF1	8911-50GF1S	8911-50GF2	8911-50GM1	8911-50GM1C	
100g	8911-100GE2	8911-100GF1	8911-100GF1S	8911-100GF2	8911-100GM1	8911-100GM1C	
200g	8911-200GE2	8911-200GF1	8911-200GF1S	8911-200GF2	8911-200GM1	8911-200GM1C	
500g	8911-500GE2	8911-500GF1	8911-500GF1S	8911-500GF2	8911-500GM1	8911-500GM1C	
1kg	8911-1KGE2	8911-1KGF1	8911-1KGF1S	8911-1KGF2	8911-1KGM1	8911-1KGM1C	
2kg	8911-2KGE2	8911-2KGF1	8911-2KGF1S	8911-2KGF2	8911-2KGM1	8911-2KGM1C	
5kg	8911-5KGE2	8911-5KGF1	8911-5KGF1S	8911-5KGF2	8911-5KGM1	8911-5KGM1C	
10kg	8911-10KGE2	8911-10KGF1	8911-10KGF1S	8911-10KGF2	8911-10KGM1	8911-10KGM1C	
20kg	8911-20KGE2	8911-20KGF1	8911-20KGF1S	8911-20KGF2	8911-20KGM1	8911-20KGM1C	
25kg	8911-25KGE2	8911-25KGF1	8911-25KGF1S	8911-25KGF2	8911-25KGM1	8911-25KGM1C	

WEIGHT SETS



37

- Supplied with manufacturer inspection certificate



8910-5KGF1

CLASS AND MATERIAL

Specification	Code				
	E2 (non-magnetic stainless steel)	F1 (non-magnetic stainless steel)	F1 (304 stainless steel)	F2 (304 stainless steel)	M1 (304 stainless steel)
1mg~100g	8910-100GE2	8910-100GF1	8910-100GF1S	8910-100GF2	8910-100GM1
1mg~200g	8910-200GE2	8910-200GF1	8910-200GF1S	8910-200GF2	8910-200GM1
1mg~500g	8910-500GE2	8910-500GF1	8910-500GF1S	8910-500GF2	8910-500GM1
1mg~1kg	8910-1KGE2	8910-1KGF1	8910-1KGF1S	8910-1KGF2	8910-1KGM1
1mg~2kg	8910-2KGE2	8910-2KGF1	8910-2KGF1S	8910-2KGF2	8910-2KGM1
1mg~5kg	8910-5KGE2	8910-5KGF1	8910-5KGF1S	8910-5KGF2	8910-5KGM1

SPECIFICATION AND SHAPE

Weight	Specification					
	1mg~100g	1mg~200g	1mg~500g	1mg~1kg	1mg~2kg	1mg~5kg
1mg	◆	◆	◆	◆	◆	◆
2mg	◆◆*	◆◆*	◆◆*	◆◆*	◆◆*	◆◆*
5mg	◆	◆	◆	◆	◆	◆
10mg	◆	◆	◆	◆	◆	◆
20mg	◆◆*	◆◆*	◆◆*	◆◆*	◆◆*	◆◆*
50mg	◆	◆	◆	◆	◆	◆
100mg	◆	◆	◆	◆	◆	◆
200mg	◆◆*	◆◆*	◆◆*	◆◆*	◆◆*	◆◆*
500mg	◆	◆	◆	◆	◆	◆
1g	■	■	■	■	■	■
2g	■◆*	■◆*	■◆*	■◆*	■◆*	■◆*
5g	■	■	■	■	■	■
10g	■	■	■	■	■	■
20g	■◆*	■◆*	■◆*	■◆*	■◆*	■◆*
50g	■	■	■	■	■	■
100g	■	■	■	■	■	■
200g		■◆*	■◆*	■◆*	■◆*	■◆*
500g			■	■	■	■
1kg				■	■	■
2kg					■◆*	■◆*
5kg						■
Quantity	21 pcs	23 pcs	24 pcs	25 pcs	27 pcs	28 pcs
Total range	1mg~211.11g	1mg~611.11g	1mg~1111.11g	1mg~2111.11g	1mg~6111.11g	1mg~11111.11g

- ◆ sheet
- cylinder
- ◆* sheet, with mark
- * cylinder, with mark



STAINLESS STEEL WEIGHTS



aluminum box (included)



8912-10KM1

- Supplied with manufacturer inspection certificate

SPECIFICATION

Weight	Class		
	F1	F2	M1
500g	8912-500F1	8912-500F2	8912-500M1
1kg	8912-1KF1	8912-1KF2	8912-1KM1
2kg	8912-2KF1	8912-2KF2	8912-2KM1
5kg	8912-5KF1	8912-5KF2	8912-5KM1
10kg	8912-10KF1	8912-10KF2	8912-10KM1
15kg	8912-15KF1	8912-15KF2	8912-15KM1
20kg	8912-20KF1	8912-20KF2	8912-20KM1
25kg	8912-25KF1	8912-25KF2	8912-25KM1

OIML R111-2004 TOLERANCE

Weight	F1	F2	M1
500g	2.5mg	8.0mg	25mg
1kg	5.0mg	16mg	50mg
2kg	10mg	30mg	100mg
5kg	25mg	80mg	250mg
10kg	50mg	160mg	500mg
20kg	100mg	300mg	1000mg

CLASS SELECTION

Resolution of the weighing instruments	Required class of weights
0.1mg	F1
1mg	F2
0.01g/0.1g	M1



CAST IRON WEIGHTS



8913-10M2

- Supplied with manufacturer inspection certificate

SPECIFICATION

Weight	Class	
	M1	M2
1kg	8913-1M1	8913-1M2
2kg	8913-2M1	8913-2M2
5kg	8913-5M1	8913-5M2
10kg	8913-10M1	8913-10M2
20kg	8913-20M1	8913-20M2
25kg	8913-25M1	8913-25M2
50kg	8913-50M1	8913-50M2
100kg	8913-100M1	8913-100M2
200kg	8913-200M1	8913-200M2
500kg	8913-500M1	8913-500M2
1000kg	8913-1000M1	8913-1000M2

OIML R111-2004 TOLERANCE

Weight	M1	M2
1kg	50mg	160mg
2kg	100mg	300mg
5kg	250mg	800mg
10kg	500mg	1600mg
20kg	1000mg	3000mg
50kg	2500mg	8000mg
100kg	5000mg	16000mg
200kg	10000mg	30000mg
500kg	25000mg	80000mg
1000kg	50000mg	160000mg

CLASS SELECTION

Resolution of the weighing instruments	Required class of weights
0.01g/0.1g	M1
0.1g	M2

SINGLE HOOK WEIGHTS

CAN BE CUSTOMIZED

ATTENTION: THE GRAVITATIONAL ACCELERATION G OF THE FORCE WEIGHTS IS TAKEN AS 9.8m/s²



37

- Supplied with manufacturer inspection certificate

SINGLE HOOK WEIGHTS FOR MASS VALUES

Weight	Class and material		
	F1 (304 stainless steel)	F2 (304 stainless steel)	M1 (2Cr13 stainless steel)
1g	8914-1GF1	8914-1GF2	8914-1GM1
2g	8914-2GF1	8914-2GF2	8914-2GM1
5g	8914-5GF1	8914-5GF2	8914-5GM1
10g	8914-10GF1	8914-10GF2	8914-10GM1
20g	8914-20GF1	8914-20GF2	8914-20GM1
50g	8914-50GF1	8914-50GF2	8914-50GM1
100g	8914-100GF1	8914-100GF2	8914-100GM1
200g	8914-200GF1	8914-200GF2	8914-200GM1
500g	8914-500GF1	8914-500GF2	8914-500GM1
1kg	8914-1KGF1	8914-1KGF2	8914-1KGM1
2kg	8914-2KGF1	8914-2KGF2	8914-2KGM1
5kg	8914-5KGF1	8914-5KGF2	8914-5KGM1
10kg	8914-10KGF1	8914-10KGF2	8914-10KGM1
15kg	8914-15KGF1	8914-15KGF2	8914-15KGM1
20kg	8914-20KGF1	8914-20KGF2	8914-20KGM1



8914-1KF2



8914-2KF2

OIML R111-2004 TOLERANCE

Weight	F1	F2	M1
1g	0.10mg	0.3mg	1.0mg
2g	0.12mg	0.4mg	1.2mg
5g	0.16mg	0.5mg	1.6mg
10g	0.20mg	0.6mg	2.0mg
20g	0.25mg	0.8mg	2.5mg
50g	0.3mg	1.0mg	3.0mg
100g	0.5mg	1.6mg	5.0mg
200g	1.0mg	3.0mg	10mg
500g	2.5mg	8.0mg	25mg
1kg	5.0mg	16mg	50mg
2kg	10mg	30mg	100mg
5kg	25mg	80mg	250mg
10kg	50mg	160mg	500mg
20kg	100mg	300mg	1000mg

SINGLE HOOK WEIGHTS FOR FORCE VALUES

Weight	Class and material		
	F1 (304 stainless steel)	F2 (304 stainless steel)	M1 (2Cr13 stainless steel)
1N	8914-1NF1	8914-1NF2	8914-1NM1
2N	8914-2NF1	8914-2NF2	8914-2NM1
5N	8914-5NF1	8914-5NF2	8914-5NM1
10N	8914-10NF1	8914-10NF2	8914-10NM1
20N	8914-20NF1	8914-20NF2	8914-20NM1
50N	8914-50NF1	8914-50NF2	8914-50NM1
100N	8914-100NF1	8914-100NF2	8914-100NM1
200N	8914-200NF1	8914-200NF2	8914-200NM1

CLASS SELECTION

Resolution of the weighing instruments	Required class of weights
0.1mg	F1
1mg	F2
0.01g/0.1g	M1

GSM (GRAMS PER SQUARE METER) CUTTER CODE 8390-100

- Suitable for cutting round samples of woolen, cotton, knitted fabrics, etc.

SPECIFICATION

Area	100cm ²
Thickness	4mm
Blade	4 pcs
Material	aluminum
Mat	rubber mat
Dimension (L×W×H)	160×160×115mm
Weight	2kg





Salt Spray Test Chambers
Page 1187



Temperature And Humidity Chambers
Page 1188-1190



Electrodynamic Vibration Systems
Page 1191-1192

SALT SPRAY TEST CHAMBERS

CUSTOMIZABLE CHAMBER SIZE

COMPLY WITH ISO STANDARD SALT SPRAY TEST REQUIREMENT



38

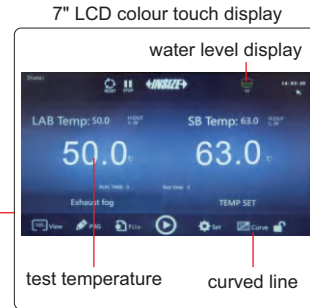

- Adopting plastic precision nozzle and cone spraying device, even mist falling, fast, long nozzle life, no crystallisation
- Spraying time can be controlled internally without the need for an external time relay
- Adjustment of brine flow and compressed air pressure by means of a flow meter and a high-pressure valve to ensure uniform salt spray deposition
- Adopt manual water filling system, water level is insufficient to automatically replenish the function, to ensure that the test is not interrupted
- USB port for download curves and historical data

SPECIFICATION

Advanced type	Code	SFT-T350	SFT-U680	SFT-E305	SFT-S410
	test condition	suitable for NSS (Neutral), AASS (Acid), CASS (Copper Accelerated) test			
Basic type	Code	SFT-S210R	SFT-G550	SFT-L965	SFT-V125
	test condition	NSS (Neutral), AASS (Acid) test only			
Chamber dimension (W×H×D)		900×600×500mm	1200×850×500mm	1600×850×550mm	2000×950×600mm
Chamber volume		270L	480L	740L	1440L
Saline tank volume		25L	90L	90L	120L
Chamber temperature		(NSS, AASS) test temperature: 35°C±1°C/(CASS) test temperature: 50°C±1°C			
Saturated barrel temperature		(NSS, AASS) test temperature: 47°C±1°C/(CASS) test temperature: 63°C±1°C			
Saline temperature		(NSS, AASS) test temperature: 35°C±1°C/(CASS) test temperature: 50°C±1°C			
Heat type		advanced type: thermal radiation heat/basic type: steam heat			
Test fluid		NSS: pure water+NaCl (pH 6.5~7.2), AASS: pure water+NaCl+CH ₃ COOH (pH 3.0~3.3) CASS: pure water+NaCl+CuCl ₂ (pH 3.0~3.3)			
Compressed air pressure		0.2MPa	0.6MPa	0.6MPa	0.6MPa
Power		2kW	3kW	4kW	4.5kW
Power supply		AC 220V, 1Ø, 50Hz			
External dimension (W×H×D)		1460×910×500mm	1900×1150×1500mm	2300×1150×1550mm	2700×1350×1600mm
Weight (basic type)		108kg	485kg	585kg	760kg
Weight (advanced type)		105kg	385kg	480kg	580kg

STANDARD DELIVERY

Main unit	1 pc
Sample holder	1 group
Sodium chloride NaCl	2 bottles
10L salt water preparation cup	1 pc
80cm ² collection cup	2 pcs
50cm glass measure cylinder	2 pcs

OPTIONAL ACCESSORY

Nozzle	SFT-S210R-NOZZLE
Brine filter	SFT-S210R-FILTER



DESKTOP TEMPERATURE AND HUMIDITY CHAMBER CODE THT-Z158

temperature and humidity control range chart

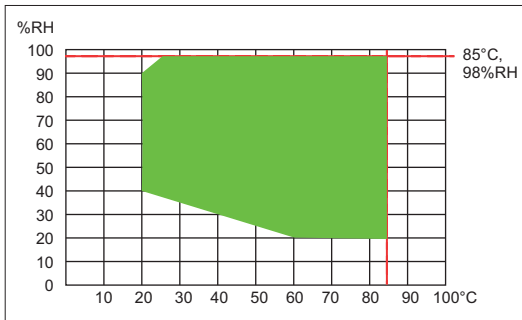

- Table design, quiet and small
- Equipped with operation system with 7 inch touch screen controller
- Intelligent refrigeration and dehumidification system, it can save 30~45% of electricity compared with traditional machines
- Output excel data report through USB port



SPECIFICATION

Chamber dimension (W×H×D)		300×350×300mm
Chamber volume		30L
Temperature range		-40~120°C
Humidity range		20%RH~98%RH
Temperature deviation		±2.0°C
Temperature fluctuation		±0.5°C
Temperature uniformity		≤2.0°C
Humidity deviation		±3.0%RH (at 75%RH~98%RH), ±5.0%RH (at 20%RH~75%RH)
Humidity fluctuation		±3.0%RH
Humidity uniformity		≤5.0%RH (at 75%RH~98%RH), ≤7.0%RH (at 20%RH~75%RH)
Heating rate		1°C/min~3°C/min
Cooling rate		0.7°C/min~1°C/min
Operation environment	temperature	5~35°C
	humidity	≤85%RH
Material	case material	cold rolled steel plate+varnish
	chamber material	SUS#304 stainless steel
	thermal insulation material	polyurethane foam
Cooling system		air-cold compressor
Protector		compressor overload protection switch, refrigerant high pressure protection switch, ceramic fuse, water plate of water shortage protection switch, electromagnetic switch, air burn protection switch, alarm
Power supply		AC220, 50/60Hz, 2kW
External dimension (W×H×D)		550×850×1050mm
Weight		125kg

STANDARD DELIVERY

Main unit	1 pc
Test hole	1 pc
Shelf	2 pcs

TEMPERATURE AND HUMIDITY CHAMBERS



temperature and humidity control range chart

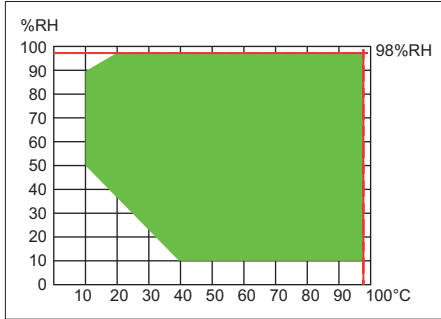

THT-A101T

- The chamber is equipped with an independent operation system with 7-inch or 10.1-inch touch screen controller
- Intelligent refrigeration and dehumidification system, combined with energy-saving control algorithm, can adjust the refrigeration level and save energy. Compared with traditional machines, it can save 30~45% of electricity
- It can output excel data report through USB port

SPECIFICATION

Code	THT-A101T	THT-A102T	THT-A103T	THT-A104T	THT-A105T
Chamber dimension (W×H×D)	500×600×500mm	500×500×400mm	500×750×600mm	700×850×700mm	1000×1000×1000mm
Chamber volume	150L	100L	225L	416L	1000L
Temperature range	-40~150°C				
Humidity range	10~98%RH				
Temperature/humidity fluctuation	±0.5°C, ±2.5%RH				
Temperature/humidity uniformity	<2°C, 5%RH				
Temperature/humidity stability	0.2°C, 2%RH				
Temperature/humidity deviation	±2°C, 3%RH				
Warm up time	about 3°C/min				
Cooling time	about 1°C/min				
Material	case material	cold rolled steel plate+varnish			
	chamber material	SUS#304 stainless steel			
	thermal insulation material	rigid polyurethane foam			
Cooling system	compressor				
Protector	no fuse switch, compressor overpressure, overheat protection, overtemperature protection, overload protection, dry burning protection, water shortage protection, etc.				
Power supply	AC220V, 50Hz, 4.5kW	AC220V, 50Hz, 2kW	AC380V, 3Ø, 50Hz, 4kW	AC380V, 3Ø, 50Hz, 3.5kW	AC380V, 3Ø, 50Hz, 3.5kW
Dimension (W×H×D)	800×1660×1400mm	750×1550×1170mm	850×1750×1200mm	950×1850×1400mm	1300×1950×1850mm
Weight	365kg	285kg	385kg	510kg	950kg

STANDARD DELIVERY

Main unit	1 pc
Test hole	1 pc
Shelf	2 pcs



PROGRAMMABLE TEMPERATURE AND HUMIDITY CHAMBER (ADVANCED TYPE) CODE HTT-A150

temperature and humidity control range diagram

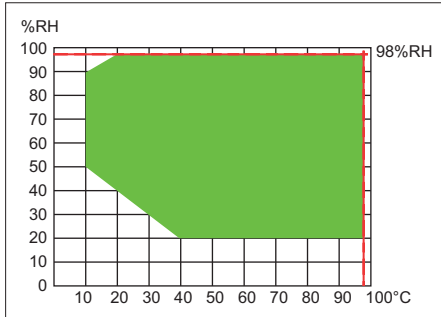

- The chamber is equipped with a standalone operation system and uses a 7-inch human-machine interface touch screen programmable controller
- Adopt advanced balanced temperature and humidity control system, dynamic PID and steam partial pressure control, HFC environmental refrigerant
- Remote control and data acquisition can be performed through the RS232 interface, and CSV data files can be directly exported to a USB flash drive

SPECIFICATION

Chamber dimension (W×H×D)		500×600×500mm
Chamber volume		150L
Temperature range		-40~150°C
Humidity range		20~98%RH
Temperature/humidity deviation		±2.0°C, ±2.5%RH
Temperature/humidity fluctuation		±0.5°C, ±2.0%RH
Temperature/humidity uniformity		±2.0°C, ±3.0%RH
Warm up time		2.0~3.0°C/min (empty)
Cooling time		1.0~1.5°C/min (empty)
Cooling system		compressor
Material	case material	double-sided galvanized steel plate+spray treatment
	chamber material	SUS#304 stainless steel
	thermal insulation	rigid polyurethane foam
Protector		total power supply phase sequence and out-of-phase protection, leakage protection, load short-circuit protection, adjustable over-temperature protection, humidification system water-deficit protection, compressor over-pressure protection, etc.
Power supply		AC380V, 50Hz, 5kW
Dimension (W×H×D)		765×1670×1575mm
Weight		370kg

STANDARD DELIVERY

Main unit	1 pc
Test hole	1 pc
Shelf	2 pcs

ELECTRODYNAMIC VIBRATION SYSTEMS



- According to ISO 5344
- Suitable for a variety of typical vibration and simulated transport tests for small and medium-sized automotive part, electronic component, household appliance and so on
- Light weight and good rigidity, high first-order resonant frequency
- High-efficiency, low-noise fan cooling, long-time continuous operation
- Power amplifier modular design, complete system interlocking protection function



EDV-AC2400

working principle

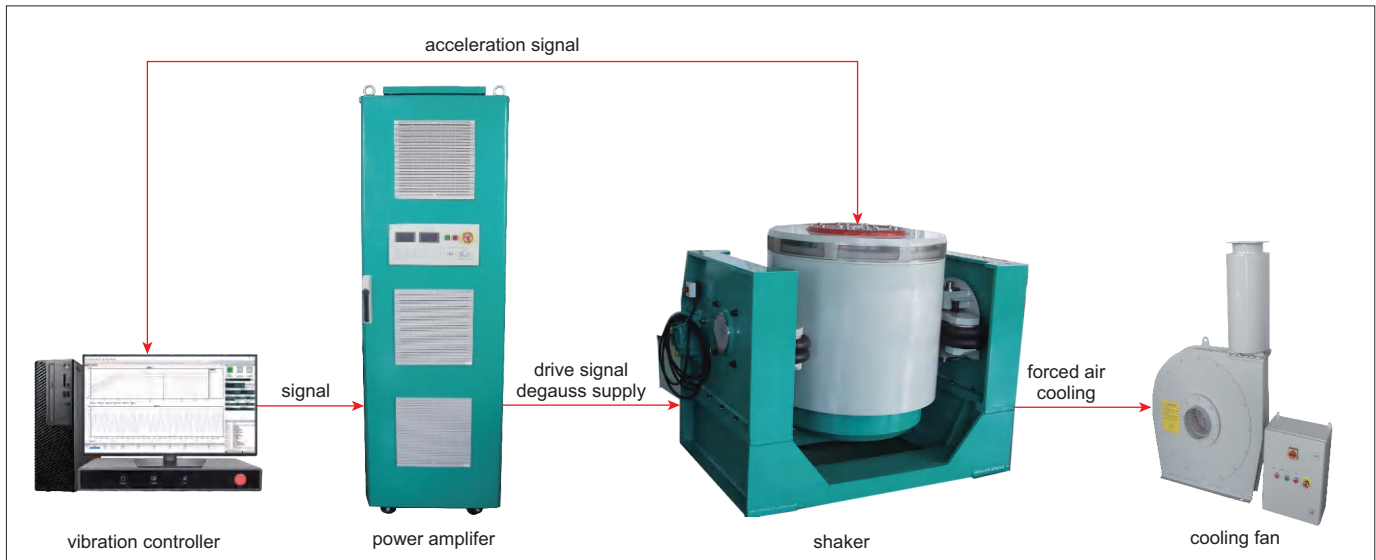

armature insert pattern

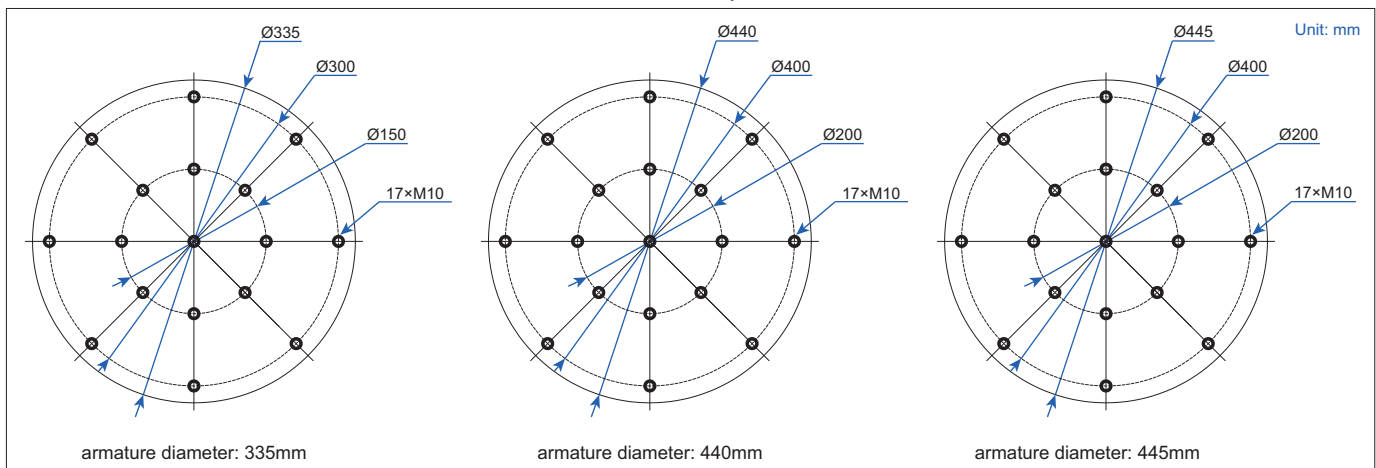

To be continued



Continued from previous page

SPECIFICATION*

Code		EDV-AC1100	EDV-AC2400	EDV-AC3000	EDV-AC4000	EDV-AC5000	
System parameter	rated sine/random force	1100kgf	2400/2200kgf	3000kgf	4000kgf	5000kgf	
	shock force	3300kgf	4800kgf	6000kgf	8000kgf	10000kgf	
	frequency range	5Hz~3500Hz	5Hz~3000Hz			5Hz~2800Hz	
	Max. acceleration	85g	100g				
	Max. velocity	2.0m/s					
	Max. displacement (P-P)	51mm					
Shaker	Max. load	300kg		500kg	1000kg		
	armature diameter	335mm		440mm		445mm	
	armature resonance	3000Hz±5%	2600Hz±5%	2500Hz±5%		2400Hz±5%	
	effective armature mass	13kg	24kg	30kg		50kg	
	inserts size	M10					
	load attachment points	17					
	natural frequency	<3Hz (thrust axis)					
	stray magnetic field	≤1mT (at 152mm above table)					
	dimension	940×715×780mm	1160×880×1050mm	1270×980×1135mm		1650×1130×1280mm	
	weight	1000kg	1700kg	2500kg		4500kg	
Power amplifier	rated output capacity	10KVA	20KVA	30KVA	40KVA	50KVA	
	signal to noise ratio	≥75dB	≥65dB				
	amplifier efficiency	≥90%					
	system protection	multiple					
	dimension	610×900×1550mm	610×900×2000mm				
	weight	400kg	460kg	500kg	520kg	560kg	
Cooling fan	power	4KVA	7.5KVA		15KVA		
	air flow	0.33m³/s	0.46m³/s		1.1m³/s		
	air pressure	0.0035 (MPa)	0.0088 (MPa)		0.0077 (MPa)		
	air duct diameter/length	Ø120×4000mm	Ø200×4500mm				
	dimension	610×750×1450mm	700×950×1500mm		1050×897×1970mm		
	weight	120kg	180kg	320kg			
Operation temperature	temperature: 0°C~40°C						
Operation humidity	humidity: 0%RH~90%RH (non-condensing)						
System power supply	3Ø AC 400V±10%, 50/60Hz						
System power	22KVA	42KVA	56KVA	76KVA	95KVA		
Compressed air requirement	0.6MPa						

* Can be customized according to test requirements

STANDARD DELIVERY

Main unit	shaker	1 pc
	amplifier	1 pc
	cooling fan	1 pc

OPTIONAL ACCESSORY **

Vibration controller	customizable
Accelerometer	
Head expander	
Slip table	
Automatic reversing device	
Fixture	
Heat insulation board	
Temperature and humidity chamber	

** Can be customized according to test requirements



Digital Oscilloscopes
Page 1194



AC/DC Digital Power Meters
Page 1195



DC Resistance Testers
Page 1196-1197



Handheld DC Ohmmeters
Page 1198



LCR Meters
Page 1199-1200



AC Ground Resistance Testers
Page 1201



AC/DC Withstanding Voltage Insulation Testers
Page 1202



Insulation Resistance Testers
Page 1203-1204



Earth Resistance Testers
Page 1204



DC Power Supplies
Page 1205



Digital Multimeters
Page 1205-1210



Digital AC/DC Clamp Meters
Page 1211



Voltage Testers
Page 1212



Soldering Irons
Page 1213



Soldering Stations
Page 1214-1215



passive probe (included)

- Analogue bandwidth: 100MHz
- Memory depth: 64kpts
- Sampling rate per channel: 1GSa/s (non-interleaved mode)
- Waveform capture rate: 5,000wfms/s
- Automatic measurement of multiple waveform parameters
- Multiple frequency standard square waves can be output:10Hz, 100Hz, 1kHz, 10kHz
- Sampling mode: real-time sampling and equivalent sampling
- Lissajous method: measuring the phase of a waveform

SPECIFICATION

Analogue bandwidth	100MHz
Channel	2
Maximum real-time sampling rate	1GSa/s (non-interleaved mode)
Rise time	≤3.5ns
Memory depth	64kpts
Waveform capture rate	5000wfms/s
Vertical scale (V/div)	1mV/div~20V/div
Time base scale (s/div)	2ns/div~50s/div
Storage method	setup, wave, bitmap
Trigger type	edge, pulse, alternate, slope, video
Trigger mode	auto, normal, single
Trigger coupling	DC, AC, HF, LF, noise
Cursor measurement	time, voltage, tracking
Parameter measurement	automatic measurement of multiple waveform parameters
Mathematical operation	+, -, ×, ÷, FFT, filter
Digital filter	low pass, high pass, band pass, band stop
Setting	internal: 20 groups, USB: 200 groups
Waveform	internal: 20 groups, USB: 200 groups
Recorded frame	1000 frames of screen data
Interface	USB Host, USB Device, Pass/Fail
Maximum input voltage	300Vrms, the transient over voltage is 1000 Vpk.
Probe compensator output	voltage: about 3Vp-p frequency: 10Hz,100Hz,1kHz, 10kHz
Power supply	AC 100V~240V, 50-60Hz
Dimension (L×W×H)	306mm×138mm×124mm
Weight	2.5kg

STANDARD DELIVERY

Main unit	1 pc
Passive probe	2 pcs
USB cable	1 pc

AC/DC DIGITAL POWER METER CODE 9670-PM70



- Basic accuracy: 0.2%
- AC/DC universal, input signal bandwidth: DC, 15Hz-5kHz
- High measurement speed, up to 0.1s refresh rate
- Voltage and current ratio function
- Sound and light alarm for voltage, current, power over the limits
- Standard RS232 interface to support test automation and data transmission

SPECIFICATION

Measurement parameters		voltage (U), current (I), active power (P), reactive power (Q), apparent power (S), power factor (λ), phase angle (\varnothing), voltage frequency (f), voltage peak (Vpk), current peak (Apk), electric energy (Wh), current integration (Ah), electric energy time (Time)
Wiring method		single phase
Voltage range		15/30/60/150/300/600V
Current range		100mA/200mA/500mA/1A/2A/5A/10A/20A
Voltage	display range	0.15V~600V
	accuracy (at 23±5°C)	DC, 15Hz≤f≤5kHz: ±(0.1%×display+0.1%×range)
Current	display range	0.5mA~20A
	accuracy (at 23±5°C)	DC, 15Hz≤f≤5kHz: ±(0.1%×display+0.1%×range)
Active power	display range	1.0mW~12kW
	accuracy (at 23±5°C)	DC, 15Hz≤f≤5kHz: PF>0.5: ±(0.1%×display+0.1%×range) PF≤0.5: ±(0.25%×display+0.25%×range)
Frequency	display range	15Hz~5kHz
	accuracy (at 23±5°C)	±(0.1%×display) (voltage amplitude should be greater than 10% of range)
Electric energy	display range	0~9999MWh
	accuracy (at 23±5°C)	±(0.5%×display)
Current integration	display range	0~9999MAh
	accuracy (at 23±5°C)	±(0.5%×display)
Power factor		±(0.010~1.000)
Ratio range (voltage, current)		0.1~6000
Interface		RS232 interface, supports MODBUS and ASCII code protocols
Power supply		AC 100V~240V, 50/60Hz
Dimension (L×W×H)		281×213×99mm
Weight		2550g

STANDARD DELIVERY

Main unit	1 pc
RS232 communication cable	1 pc

 test probe 9651-TL
(optional)

- Maximum reading: 220000
- Basic accuracy: 0.05%
- 3.5 inch LCD screen
- Temperature compensation function
- Short-circuit zeroing calibration
- Bad contact detection
- Comparator: pass or fail judge
- Keyboard lock function



temperature probe (included)

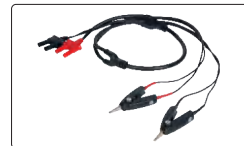

test clip (included)

 RS232 communication cable
(included)

SPECIFICATION

Function	Range	Resolution	Accuracy ("d" is the least reading)
Slow test	20mΩ	0.001mΩ	±(0.1%+3d)
	200mΩ/2Ω/20Ω/200Ω/ 2kΩ/20kΩ/200kΩ	0.001mΩ/0.00001Ω/0.0001Ω/0.001Ω/ 0.00001kΩ/0.0001kΩ/0.001kΩ	±(0.05%+2d)
	2MΩ	0.0001MΩ	±(0.1%+5d)
Medium speed test	20mΩ	0.001mΩ	±(0.2%+5d)
	200mΩ/2Ω/20Ω/200Ω/ 2kΩ/20kΩ/200kΩ	0.001mΩ/0.00001Ω/0.0001Ω/0.001Ω/ 0.00001kΩ/0.0001kΩ/0.001kΩ	±(0.1%+3d)
	2MΩ	0.0001MΩ	±(0.2%+5d)
Fast test	20mΩ	0.01mΩ	±(0.8%+5d)
	200mΩ/2Ω/20Ω/200Ω/ 2kΩ/20kΩ/200kΩ	0.01mΩ/0.0001Ω/0.001Ω/0.01Ω/ 0.0001kΩ/0.001kΩ/0.01kΩ	±(0.5%+5d)
	2MΩ	0.001MΩ	±(0.8%+5d)
Range mode	auto range, manual range and nominal range		
Test speed	slow: 3t/s, medium speed: 18t/s, fast: 60t/s		
Trigger	internal trigger, manual trigger, external trigger		
Interface	handler interface, RS232 interface, RS485 interface, USB interface and temperature compensation interface		
Power supply	AC 100V~240V, 50Hz/60Hz		
Dimension (L×W×H)	307×264×107mm		
Weight	2.5kg		

STANDARD DELIVERY

Main unit	1 pc
RS232 communication cable	1 pc
Temperature probe	1 pc
Test clip	1 pc

OPTIONAL ACCESSORY

Test probe	9651-TL
------------	---------

**DC RESISTANCE TESTER
CODE 9654-LW50**



- Maximum reading: 5000
- Basic accuracy: 0.2%
- 0.8 inch high brightness digital tube
- Full-range short-circuit zero function
- Comparator function: upper and lower limit alarms



test clip (included)

SPECIFICATION

Function	Range	Resolution	Accuracy ("d" is the least reading)
Slow test	50mΩ	0.01mΩ	±(0.2%+5d)
	500mΩ	0.1mΩ	±(0.2%+3d)
	5Ω/50Ω/500Ω/5kΩ	0.001Ω/0.01Ω/0.1Ω/0.001 kΩ	±(0.2%+2d)
	50kΩ	0.01kΩ	±(0.2%+3d)
	200kΩ	0.1kΩ	±(0.2%+5d)
Fast test	50mΩ	0.01mΩ	±(0.5%+5d)
	500mΩ/5Ω/50Ω/500Ω/ 5kΩ/50kΩ	0.1mΩ/0.001Ω/0.01Ω/ 0.1Ω/0.001kΩ/0.01kΩ	±(0.5%+3d)
	200kΩ	0.1kΩ	±(0.5%+5d)
Range mode	auto range and manual range		
Test speed	slow: 3t/s, fast: 10t/s		
Beep	OK, NG		
Power supply	AC 220V±10%, 50Hz		
Dimension (L×W×H)	259×220×85mm		
Weight	2.1kg		

STANDARD DELIVERY

Main unit	1 pc
Test clip	1 pc



- Maximum reading: 20000
- Basic accuracy: 0.05%
- 3.5 inch LCD screen with adjustable backlight
- Temperature compensation function
- Full-range short-circuit zero function
- Comparator function: upper and lower limit alarms
- Data hold
- Keyboard lock function
- Automatic power off



test clip (included)

SPECIFICATION

Function		Range	Resolution	Accuracy ("d" is the least reading)
High current mode	Slow & medium speed test	20mΩ	0.01mΩ	±(0.5%+3d)
		200mΩ/2Ω/20Ω/200Ω/ 2kΩ/20kΩ/200kΩ	0.01mΩ/0.0001Ω/0.001Ω/0.01Ω/ 0.0001kΩ/0.001kΩ/0.01kΩ	±(0.05%+1d)
		2MΩ	0.0001MΩ	±(0.5%+1d)
	Fast speed test	20MΩ	0.01MΩ	±(1%+3d)
		20mΩ	0.01mΩ	±(0.5%+5d)
		200mΩ/2Ω/20Ω/200Ω/ 2kΩ/20kΩ/200kΩ	0.01mΩ/0.0001Ω/0.001Ω/0.01Ω/ 0.0001kΩ/0.001kΩ/0.01kΩ	±(0.1%+3d)
Low current mode *	Slow, medium, fast speed test	2MΩ	0.0001MΩ	±(1%+3d)
		20MΩ	0.01MΩ	±(2%+5d)
		20mΩ	0.01mΩ	±(0.5%+5d)
		200mΩ/2Ω/20Ω/200Ω/ 2kΩ/20kΩ/200kΩ	0.01mΩ/0.0001Ω/0.001Ω/0.01Ω/ 0.0001kΩ/0.001kΩ/0.01kΩ	±(0.1%+3d)
Range mode		auto range, manual range and nominal range		
Test speed		slow: 3t/s, medium speed: 15t/s, fast: 30t/s		
Trigger		internal trigger, manual trigger, remote trigger		
Interface		Mini USB interface, compatible with SCPI command		
Power supply		rechargeable lithium battery (operation time ≥ 8 hours)		
Dimension		130×210×38mm		
Weight		700g		

* When using the 2MΩ and 20MΩ ranges, it is recommended to select the high current mode

STANDARD DELIVERY

Main unit	1 pc
Power adapter	1 pc
Mini USB communication cable	1 pc
Test clip	1 pc

OPTIONAL ACCESSORY

Test probe	9650-TL
------------	---------

**LCR METER
CODE 9653-YS01**



- 3.5-inch TFT LCD display
- Basic accuracy: 0.05%
- Auto level control
- Calibration function: full-scale open circuit and short-circuit sweep frequency clear, three groups of users point frequency calibration
- List test: cyclic scanning of up to 10 groups of frequency or level is performed and the results are compared to the set values
- Comparator: 11-level sorting function, up to 999,999 measured parts can be counted



kelvin clip lead
(include)



test fixture
(include)



SMD test fixture
(optional)



short-circuit plate
(included)



SMD tweezer lead
(optional)



SMD tweezer lead
(optional)

SPECIFICATION

Parameters	Cs-Rs, Cs-D, Cp-Rp, Cp-D, Lp-Rp, Lp-Q, Ls-Rs, Ls-Q, G-B, R-X, Z-θrad, Z-θdeg, DCR
Monitor parameters	Z, D, Q, θrad, θdeg, R, X, G, B, Y, Vac, Iac, Δ, Δ%
Test frequency	10Hz~100kHz
Signal level	voltage: 10mV~2V; current: 100μA~20mA
DC bias	-2.5V~+2.5V
Source resistance	30Ω, 50Ω, 100Ω
Range	auto range, manual range and nominal range, 9 levels of ranges
Maximum reading	main parameter: 999999; secondary parameter: 999999
Test speed	fast: 40 t/s; medium speed: 10 t/s; slow: 3 t/s
Comparator	11-level sorting, 9-level GD, 1-level NG, 1-level AUX
Interface	RS232 interface, RS485 interface, USB interface, HANDLER interface
Power supply	AC 100V~240V, 50/60Hz
Dimension (L×W×H)	350×264×107mm
Weight	2.6kg

STANDARD DELIVERY

Main unit	1 pc
Kelvin clip lead	1 pc
Test fixture	1 pc
Short-circuit plate	1 pc

OPTIONAL ACCESSORY

SMD test fixture	9653-ST01
SMD tweezer lead	9653-ST02
SMD tweezer lead	9653-ST03

DATA
OUTPUT

INSPECTION
CERTIFICATE



HANDHELD LCR METER CODE 9652-RC02

39



SMD tweezer lead
(included)



short-circuit plate
(included)

- Automatic measure inductance (L), capacitance (C), resistance (R), impedance (Z), quality factor (Q), dissipation factor (D), phase (θ) and DC resistance (DCR)
- Internal trigger
- Data hold
- Full range open and short compensation
- Equivalent circuit: series and parallel
- Compare main parameter with nominal value and display percent deviation
- Built in USB-C interface for data transmission and charging
- Language: English, Chinese
- LCD touch screen with adjustable backlight
- Automatic power off



kelvin clip lead
(included)

SPECIFICATION

Measuring parameters	C-D, C-Q, C-R, L-D, L-Q, L-R, L-Rdc, R-Q, R-X, R-Rdc, Rdc, Z-D, Z-Q, Z- θ r, Z- θ d
Range	8 levels, auto range or hold range
Basic accuracy	0.2%
Test frequency	50Hz, 60Hz, 100Hz, 120Hz, 200Hz, 400Hz, 500Hz, 1kHz, 2kHz, 4kHz, 5kHz, 10kHz, 20kHz, 40kHz, 50kHz, 100kHz accuracy: 0.02%
Signal level	0.1V, 0.3V, 0.7V, 1V; accuracy: 10%
Test speed	slow 2.5 times/sec, fast 10 times/sec
Interface	USB-C interface: support HID and VCOM communication, compatible with SCPI command
Operation environment	0°C~40°C, <80%RH
Working time	50% brightness: 9h; 100% brightness : 7h
Power supply	rechargeable Li-ion battery
Power	<1.5W
Dimension	195×90×41mm
Weight	380g

STANDARD DELIVERY

Main unit	1 pc
Kelvin clip lead	1 pc
SMD tweezer lead	1 pc
Short-circuit plate	1 pc

AC GROUND RESISTANCE TESTER CODE 9460-GR40



- 5-inch LCD touch screen display
- Comparator function: sound and light alarms for upper and lower limit
- User correction function
- Keyboard lock function



test clamps (included)

SPECIFICATION

Current	range	AC 5A~40A
	resolution	0.1A
	accuracy	$\pm(2\%+5d)$
Resistance test	range	0~600m Ω
	resolution	0.1m Ω
	accuracy	$\pm(2\%+5d)$
Frequency		50Hz, 60Hz
Output voltage		$\leq 6V$
Output power		when the input voltage is 110V, the output power $\leq 75VA$; when the input voltage is 220V, the output power $\leq 150VA$
Time		0~999.9s
Interface		HANDLER interface, RS-232C interface
Power supply		AC 110V/220V, 50Hz/60Hz
Dimension (L×W×H)		320×250×120mm
Weight		7kg

STANDARD DELIVERY

Main unit	1 pc
Test clamp	2 pcs

AC/DC WITHSTANDING VOLTAGE INSULATION TESTER CODE 9453-ST01



VIDEO



high voltage test clips (included)

high voltage test rod
(included)RS232 communication cable
(included)

- 5-inch LCD touch screen display
- Arc detection function
- Electric shock protection function
- 10 test files can be stored, each file can be edited with 16 test steps
- Standard communication interface to meet automation test requirements
- Applications: home appliance, transformer, electrical device, component

SPECIFICATION

Withstand voltage test	output voltage	range	AC: 5kV; DC: 6kV
		resolution (d)	0.001kV
		accuracy	$\pm(2\%+5d)$
	test current	range	AC: 10mA; DC: 5mA
		resolution (d)	AC: 0.001mA~0.01mA; DC: 0.1 μ A~0.01mA
		accuracy	$\pm(2\%+5d)$
Insulation resistance test	output voltage	range	1kV
		resolution (d)	0.001kV
		accuracy	$\pm(1\%+2d)$
	test resistance	range	10G Ω
		resolution (d)	0.001M Ω ~0.01G Ω
		accuracy	output voltage \geq 500V, test resistance 1M Ω -1G Ω : $\pm(5\%+5d)$; output voltage \geq 500V, test resistance 1G Ω -10G Ω : $\pm(10\%+5d)$; output voltage<500V, test resistance 0.1M Ω -1G Ω : $\pm(10\%+5d)$
Discharge function			discharge after testing
Arc detection			1~9 level (AC/DC), factory default is 5
Time			voltage rising time: 0.1s~999.9s; voltage falling time: 0.1s~999.9s; voltage testing time: 0.1s~999.9s
Interface			HANDLER interface, RS232C interface, USB interface
Operation environment			temperature: 10°C~40°C; relative humidity: \leq 70%
Power supply			AC 110V/220V, 50Hz/60Hz
Dimension (L×W×H)			450×270×130mm
Weight			9.2kg

STANDARD DELIVERY

Main unit	1 pc
High voltage test clip	2 pcs
High voltage test rod	1 pc
RS232 communication cable	1 pc

INSULATION RESISTANCE TESTER CODE 9454-SR35

DATA
OUTPUT

computer software (included):
connects to PC via USB cable,
displays and stores data

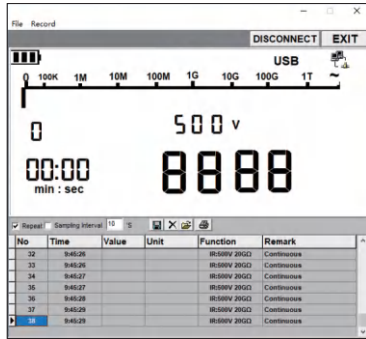

- Continuous measurement, comparative measurement
- Timed measurement, polarization index measurement
- AC and DC voltage measurement
- Data storage, USB interface data transmission
- High voltage output warning, automatic discharge
- Battery level indication
- Backlight display function
- Auto power off function

SPECIFICATION

Insulation resistance	test voltage *	500V	1000V	2500V	5000V
	range	0.5MΩ~20MΩ	1MΩ~40GΩ	2.5MΩ~100GΩ	5MΩ~1000GΩ
	resolution	0.5MΩ~99.9MΩ: 0.1MΩ 100MΩ~999MΩ: 1MΩ 1GΩ~9.99GΩ: 0.01GΩ 10GΩ~1000GΩ: 0.1GΩ			
	accuracy **	0.5MΩ~99.9MΩ: ±(3%+5d) 100MΩ~9.99GΩ: ±(5%+5d) 10GΩ~99.9GΩ: ±(10%+5d) 100GΩ~1000GΩ: ±(20%+5d)			
DC voltage	range	±(30~600)V			
	resolution	1V			
	accuracy	±(2%+3d)			
AC voltage (50/60Hz)	range	(30~600)V			
	resolution	1V			
	accuracy	±(2%+3d)			
Short-circuit current	>3.0mA				
Operation environment	temperature: -10°C~40°C; humidity: ≤85%RH				
Power supply	8 LR14 batteries or power adapter				
Dimension	202×155×94mm				
Weight	1.28kg				

* Open-circuit voltage: DC voltage 0%~+20%

** Insulation resistance of 100GΩ or more should be measured under 50% RH humidity

STANDARD DELIVERY

Main unit	1 pc
Alligator clip test lead	3 pcs
Battery (LR14)	8 pcs
Power adapter	1 pc
USB cable	1 pc

**INSULATION RESISTANCE TESTER
CODE 9452-IR21**



- Continuous measurement: press and rotate the test button to measure continuously
- Alarm function: the tester alerts with buzzer when the insulation resistance is less than 4MΩ
- Over-range indication
- Data hold
- High-voltage output alert
- Auto backlight display
- Low battery indication
- Auto power off



test clips (included)



test leads (included)

SPECIFICATION

Insulation resistance	test voltage*	100V	250V	500V	1000V
	range	100MΩ	500MΩ	2.00GΩ	5.00GΩ
	resolution	0.00MΩ~9.99MΩ: 0.01MΩ 10.0MΩ~99.9MΩ: 0.1MΩ 100MΩ~999MΩ: 1MΩ 1.00GΩ~5.00GΩ: 0.01GΩ			
	accuracy	0~99.9MΩ: ±(3%+5d); 100MΩ~5.00GΩ: ±(5%+5d)			
AC voltage**	range	30~750V (50/60Hz)			
	resolution	1V			
	accuracy	±(2%+3d)			
Short-circuit current	<2.0mA				
Operation environment	temperature: 0°C~35°C; humidity: <75%RH				
Power supply	6×1.5V AA batteries or AC/DC adapter (optional)				
Dimension	184×115×75mm				
Weight	600g				

*Open-circuit voltage: DC voltage 0~+10%

**Data hold and backlight display function are not applicable for AC voltage measurement

STANDARD DELIVERY

Main unit	1 pc
Test lead	2 pcs
Test clip	2 pcs
Battery (AA)	6 pcs

OPTIONAL ACCESSORY

AC/DC adapter	9452-AP
---------------	---------



**EARTH RESISTANCE TESTER
CODE 0716-ER120**

- Timed measurement function
- Auto power off
- Display with backlight
- Data hold
- Low battery indication

auxiliary grounding rods (included)



SPECIFICATION

Function	Range	Resolution	Accuracy ("d" is the least reading)
Earth resistance	20Ω	0.01Ω	±(2%+10d)
	200Ω/2000Ω	0.1Ω/1Ω	±(2%+3d)
AC earth voltage	1000V	1V	±(2%+5d)
DC voltage	1500V	1V	±(1%+5d)
Test methods	2-wire testing, 3-wire testing		
Power supply	8×1.5V AA batteries		
Dimension	178×110×59mm		
Weight	600g		

STANDARD DELIVERY

Main unit	1 pc
Test lead	5 pcs
Auxiliary grounding rod	2 pcs
Battery (AA)	8 pcs

DC POWER SUPPLY CODE 9914-BP506



SPECIFICATION

Rate output voltage	0~50V	
Rate output current	0~6A	
Maximum output power	150W	
Voltage	setting resolution	10mV
	setting accuracy	≤0.5%+50mV
	readback resolution	10mV
	readback accuracy	≤0.5%+50mV
	load regulation	≤0.05%+5mV
	line regulation	≤0.1%+3mV
	ripple	≤5mVrms
Current	setting resolution	1mA
	setting accuracy	≤0.5%+5mA
	readback resolution	1mA
	readback accuracy	≤0.5%+5mA
	load regulation	≤0.1%+3mA
	line regulation	≤0.1%+3mA
ripple	≤20mArms	
OVP	0~55V	
OCP	0~6.5A	
Work condition	temperature: 0°C~40°C, humidity: ≤75%RH	
Storage condition	temperature: -20°C~50°C, humidity: ≤90%RH	
Cool system	fan cool	
Power supply	110V/220V±10%, 50Hz/60Hz	
Dimension	200×80×155mm	
Weight	1.23kg	

- Four-digit LED display
- Independent voltage and current control knob
- Output switch control
- Panel locking function to prevent misoperation
- USB interface for power supply
- OVP/OCP protection
- 3 shortcut keys for presetting

STANDARD DELIVERY

Main unit	1 pc
Test lead	2 pcs

PEN-TYPE DIGITAL MULTIMETER CODE 9241-ML200



- Auto/manual ranging
- Maximum mode
- Data hold
- NCV detection
- Low battery indication
- Auto power off
- Safety rating: CAT III 600V

STANDARD DELIVERY

Main unit	1 pc
Test lead	1 pc
Clip	2 pcs
Battery (AAA)	2 pcs



test lead (included)



clips (included)

SPECIFICATION

Function	Range	Resolution	Accuracy
DC Voltage	200mV/2V/20V/200V/600V	0.1mV/1mV/10mV/0.1V/1V	±(0.7%+2)
AC Voltage	200mV/2V/20V/200V	0.1mV/1mV/10mV/0.1V	±(0.8%+3)
	600V	1V	±(1.0%+3)
DC Current	20mA/200mA	10μA/0.1mA	±(1.5%+3)
AC Current	20mA/200mA	10μA/0.1mA	±(2.0%+3)
Resistance	200Ω	0.1Ω	±(1.0%+3)
	2kΩ/20kΩ/200kΩ/2MΩ	1Ω/10Ω/0.1kΩ/1kΩ	±(1.0%+1)
	20MΩ	10kΩ	±(1.0%+5)
Logic level test	<1.5V (green LED on); 1.5~3.5V (green & red LED off); >3.5V (red LED on)		
Diode	open circuit voltage 1.5V		
Continuity buzzer	<50Ω		
Power supply	2×1.5V AAA batteries		



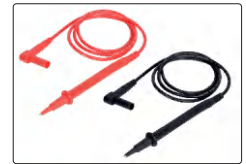

test leads (included)

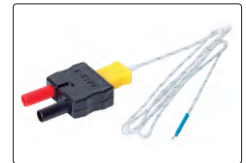

temperature probe and adapter (included)

- 2000 counts digital display
- Auto ranging (except 200mV AC)
- Data hold
- Max hold
- Display with backlight
- Low battery indication
- Auto power off
- Safety rating: CAT III 600V

SPECIFICATION

Function	Range	Resolution	Accuracy ("d" is the least reading)
DC Voltage	200mV	0.1mV	$\pm(0.5\%+2d)$
	2V/20V/200V	0.001V/0.01V/0.1V	$\pm(1.0\%+2d)$
	600V	1V	$\pm(1.2\%+2d)$
AC Voltage (50~60Hz)	200mV	0.1mV	$\pm(1.5\%+30d)$
	2V	0.001V	$\pm(1.2\%+3d)$
	20V/200V	0.01V/0.1V	$\pm(1.5\%+3d)$
DC Current	600V	1V	$\pm(2.0\%+4d)$
	200 μ A	0.1 μ A	$\pm(1.0\%+3d)$
	2000 μ A/20mA/200mA	1 μ A/0.01mA/0.1mA	$\pm(1.5\%+3d)$
AC Current (50~60Hz)	10A	0.01A	$\pm(2.5\%+5d)$
	200 μ A	0.1 μ A	$\pm(1.5\%+5d)$
	2000 μ A/20mA/200mA	1 μ A/0.01mA/0.1mA	$\pm(1.8\%+5d)$
Resistance	10A	0.01A	$\pm(3.0\%+7d)$
	200 Ω	0.1 Ω	$\pm(1.2\%+4d)$
	2k Ω	0.001k Ω	$\pm(1.0\%+2d)$
	20k Ω /200k Ω /2M Ω	0.01k Ω /0.1k Ω /0.001M Ω	$\pm(1.2\%+2d)$
Temperature (type-K)	20M Ω	0.01M Ω	$\pm(2.0\%+3d)$
	-50°C to 1000°C	1°C	$\pm(3.0\%+5^\circ\text{C})$
	-58°F to 1832°F	1°F	$\pm(3.0\%+8^\circ\text{F})$
Diode test	test current: 0.3mA typical	1mV	$\pm(10\%+5d)$
Continuity check	less than 100 Ω		
Power supply	9V battery		
Dimension (L×W×H)	150×70×48mm		
Weight	255g		

STANDARD DELIVERY

Main unit	1 pc
Thermocouple adapter	1 pc
Temperature probe	1 pc
9V battery	1 pc
Test lead	2 pcs

MINI DIGITAL MULTIMETER (BASIC TYPE) CODE 9242-ML100A



- Portable size with protective case
- 1999 counts digital display
- Data hold
- Display with backlight
- Low battery indication
- Auto power off
- Safety rating: CAT II 600V

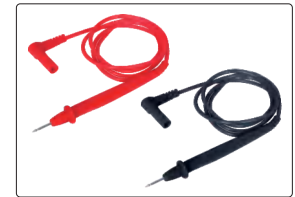

test leads (included)

SPECIFICATION

Function	Range	Resolution	Accuracy ("d" is the least reading)
DC Voltage	200.0mV	0.1mV	±(0.7%+3d)
	2000mV	1mV	±(0.5%+2d)
	20.00V/200.0V/600V	0.01V/0.1V/1V	±(0.7%+3d)
AC Voltage (40~400Hz)	200.0V/600V	0.1V/1V	±(1.2%+3d)
DC Current	200.0µA/200.0mA	0.1µA/0.1mA	±(1.0%+2d)
	10.00A	0.01A	±(1.2%+5d)
Resistance	200.0Ω	0.1Ω	±(1.0%+2d)
	2000Ω/20.00kΩ/200.0kΩ	1Ω/0.01kΩ/0.1kΩ	±(0.8%+2d)
	20.00MΩ	0.01MΩ	±(1.2%+3d)
Battery test	1.5V/9V/12V battery check		
Diode test	open circuit voltage: 2.1V DC		
Continuity test	<50Ω		
Power supply	2×1.5V AAA batteries		
Dimension (LxWxH)	134×77×47mm		
Weight	206g		

STANDARD DELIVERY

Main unit	1 pc
Battery (AAA)	2 pcs
Test lead	2 pcs

SMART DIGITAL MULTIMETER CODE 9247-190

- Automatically identify test modes for AC voltage/DC voltage/resistance/continuity
- NCV detection and judge the strength by light and buzzer
- Self-calibration when power on to ensure accuracy
- LIVE firewire recognition
- Display with backlight
- True RMS measurement
- Data hold
- Low battery indication
- Auto power off
- Safety rating: CAT III 600V



test leads (included)



STANDARD DELIVERY

Main unit	1 pc
Test lead	2 pcs
Battery (CR2032)	2 pcs

SPECIFICATION

Function	Range	Resolution	Accuracy
DC Voltage	60mV/600mV/6V/60V/600V	0.01mV/0.1mV/0.001V/0.01V/0.1V	±(0.5%+3)
AC Voltage	60mV/600mV/6V/60V/600V	0.01mV/0.1mV/0.001V/0.01V/0.1V	±(1.0%+3)
DC Current	6000µA/60mA/600mA	1µA/0.01mA/0.1mA	±(1.2%+5)
AC Current	6000µA/60mA/600mA	1µA/0.01mA/0.1mA	±(1.5%+5)
Resistance	600Ω/6kΩ/60kΩ/600kΩ	0.1Ω/0.001kΩ/0.01kΩ/0.1kΩ	±(1.0%+5)
	6MΩ/60MΩ	0.001MΩ/0.01MΩ	±(1.5%+3)
Capacitance	6nF/60nF/600nF/6µF/60µF/600µF	0.001nF/0.01nF/0.1nF/0.001µF/0.01µF/0.1µF	±(4.0%+5)
	6mF/60mF	0.001mF/0.01mF	±(5.0%+5)
Frequency	10Hz/100Hz/1000Hz/10kHz/100kHz/1000kHz	0.001Hz/0.01Hz/0.1Hz/0.001kHz/0.01kHz/0.1kHz	±(1.0%+5)
	10MHz	0.001MHz	±(3.0%+5)
Duty cycle	1~99%	0.1%	±(3.0%+5)
Diode measurement	open circuit voltage 2.0V		
Continuity measurement	<50Ω		
Power supply	2×3V CR2032 batteries		
Dimension (L×W×H)	133×68×18mm		
Weight	178g		



DIGITAL MULTIMETER (WITH JACK INDICATOR LIGHT) CODE 9246-180



- Jack indicator light: jacks flash green to indicate the corresponding jacks for test leads
- NCV detection and judge the strength by light and buzzer
- Self-calibration when power on to ensure accuracy
- LIVE firewire recognition
- Double color backlight (orange backlight prompts high voltage or current: the orange backlight automatically lights up when voltage is higher than 80V or the current is higher than 1A)
- Large range capacitance meter 100mF
- True RMS measurement
- Battery test function
- Max/Min mode
- Data hold
- Low battery indication
- Auto power off
- Safety rating: CAT III 1000V, CAT IV 600V



test leads (included)

STANDARD DELIVERY

Main unit	1 pc
Test lead	2 pcs
Battery (AA)	2 pcs

SPECIFICATION

Function	Range	Resolution	Accuracy
DC Voltage	600mV/6V/60V/600V/1000V	0.1mV/0.001V/0.01V/0.1V/1V	±(0.5%+3)
AC Voltage	6V/60V/600V/750V	0.001V/0.01V/0.1V/1V	±(0.8%+5)
DC Current	60μA/60mA/600mA/10A	0.01μA/0.01mA/0.1mA/0.01A	±(1.2%+3)
AC Current	60mA/600mA/10A	0.01mA/0.1mA/0.01A	±(1.5%+3)
Resistance	600Ω/6kΩ/60kΩ/600kΩ	0.1Ω/0.001kΩ/0.01kΩ/0.1kΩ	±(1.0%+3)
	6MΩ/60MΩ	0.001MΩ/0.01MΩ	±(1.5%+3)
Capacitance	10nF/100nF/1000nF/10μF/100μF/1000μF	0.001nF/0.01nF/0.1nF/0.001μF/0.01μF/0.1μF	±(4.0%+5)
	10mF/100mF	0.001mF/0.01mF	±(5.0%+5)
Frequency	10Hz/100Hz/1000Hz/10kHz/100kHz/1000kHz	0.001Hz/0.01Hz/0.1Hz/0.001kHz/0.01kHz/0.1kHz	±(1.0%+3)
	10MHz	0.001MHz	±(3.0%+3)
Duty cycle	1~99%	0.1%	±(3.0%+3)
Diode measurement	forward DC current 2.5mA, reverse DC voltage 3.0V		
Continuity measurement	<30Ω		
Power supply	2×1.5V AA batteries		
Dimension (L×W×H)	188×88×50mm		
Weight	424g		

BLUETOOTH DIGITAL MULTIMETER CODE 9219-KV220

DATA
OUTPUT



- Built-in bluetooth
- Mobile app is included
- 9999 counts digital display
- True RMS measurement
- Display with backlight
- Relative measurement mode
- Auto/manual ranging
- Auto power off
- Data hold
- NCV detection
- Low battery indication
- Safety rating: CAT III 600V

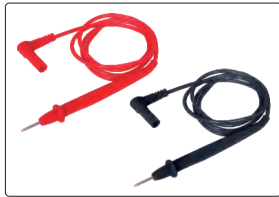

test leads (included)

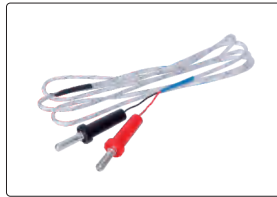

temperature probe (included)

app (included)

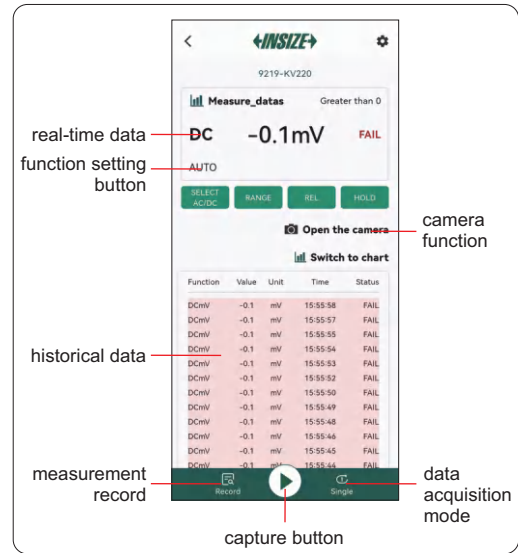

STANDARD DELIVERY

Main unit	1 pc
Test lead	2 pcs
Temperature probe	1 pc
Battery (AAA)	3 pcs

SPECIFICATION

Function	Range	Resolution	Accuracy ("d" is the resolution)	
DC Voltage	9.999mV/99.99mV	0.001mV/0.01mV	±(0.7%+8d)	
	999.9mV/9.999V/99.99V/999.9V	0.1mV/0.001V/0.01V/0.1V	±(0.5%+3d)	
AC Voltage (40~400Hz)	9.999mV/99.99mV	0.001mV/0.01mV	±(1.0%+3d)	
	999.9mV/9.999V/99.99V/999.9V	0.1mV/0.001V/0.01V/0.1V	±(0.8%+3d)	
DC Current	999.9µA	0.1µA	±(0.8%+3d)	
	999.9mA/9.999A	0.1mA/0.001A	±(1.0%+3d)	
AC Current (40~400Hz)	999.9µA	0.1µA	±(1.0%+3d)	
	999.9mA/9.999A	0.1mA/0.001A	±(1.2%+3d)	
Resistance	999.9Ω/9.999kΩ/99.99kΩ/999.9kΩ	0.1Ω/0.001kΩ/0.01kΩ/0.1kΩ	±(0.8%+2d)	
	9.999MΩ	0.001MΩ	±(1.5%+3d)	
	99.99MΩ	0.01MΩ	±(2.0%+5d)	
Capacitance	9.999nF	0.001nF	±(4.0%+10d)	
	9.999nF/99.99nF/999.9nF/9.999µF	0.001nF/0.01nF/0.1nF/0.001µF	±(4.0%+5d)	
	99.99µF/999.9µF	/0.01µF/0.1µF		
Frequency	9.999mF	0.001mF	±(10.0%)	
	99.99Hz~9.999MHz	0.01Hz~0.001MHz	±(0.1%+5d)	
Temperature	-40~1000°C	-40~0°C	1°C	±4°C
		>0~100°C	1°C	±(1.0%+5d)
		>100~1000°C	1°C	±(2.0%+5d)
	-40~1832°F	-40~32°F	1°F	±5°F
		>32~212°F	1°F	±(1.5%+5d)
>212~1832°F	1°F	±(2.5%+5d)		
Duty cycle	0.1%~99.9%	0.1%	±(3%+5d)	
Diode test	open circuit voltage 3.3V, test current 1.5mA			
Continuity check	<30Ω			
Power supply	3×1.5V AAA batteries			
Dimension (L×W×H)	187×88×56mm			
Weight	400g			

**DIGITAL MULTIMETER
CODE 9215-E510**

**DATA
OUTPUT**

- 22000 counts digital display
- Data transmission via USB
- True RMS measurement
- Data hold
- Peak/Max/Min mode
- Low pass filter function
- NCV detection
- Low battery indication
- Auto power off
- Safety rating: CAT III 1000V, CAT IV 600V

 USB connection cable
(included)

 conversion plug (transistor)
(included)

computer software (included): connect to PC software via USB cable to collect, display and store data

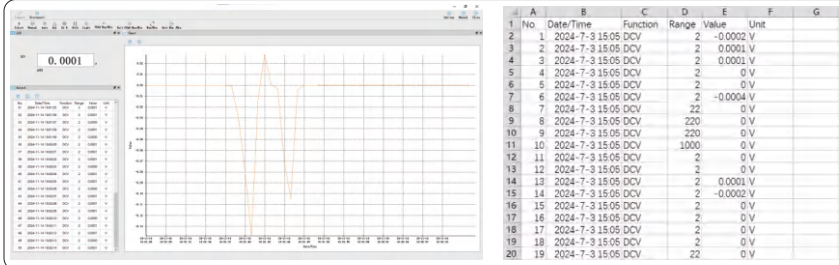

STANDARD DELIVERY

Main unit	1 pc
Test lead	2 pcs
USB connection cable	1 pc
Conversion plug (transistor)	1 pc
Battery (AAA)	4 pcs

SPECIFICATION

Function	Range	Resolution	Accuracy ("d" is the resolution)
DC Voltage	220mV	0.01mV	±(0.1%+5d)
	2.2V/22V/220V	0.1mV/0.001V/0.01V	±(0.05%+5d)
	1000V	0.1V	±(0.1%+5d)
AC Voltage	220mV	0.01mV	±(1.0%+10d), 40Hz~1kHz ±(1.5%+30d), 1kHz~10kHz
	2.2V/22V	0.1mV/1mV	±(0.8%+10d), 40Hz~1kHz ±(1.2%+50d), 1kHz~10kHz
	220V	10mV	±(0.8%+10d), 40Hz~1kHz ±(2.0%+50d), 1kHz~10kHz
	1000V	0.1V	±(1.2%+10d), 40Hz~1kHz ±(3.0%+50d), 1kHz~10kHz
DC Current	220μA/2200μA/22mA/220mA	0.01μA/0.1μA/0.001mA/0.01mA	±(0.5%+10d)
	20A	0.001A	±(1.2%+50d)
AC Current	220μA/2200μA	0.01μA/0.1μA	±(0.8%+10d), 40Hz~1kHz ±(3.0%+50d), 1kHz~10kHz
	22mA/220mA/20A	0.001mA/0.01mA/0.001A	±(1.2%+10d), 40Hz~1kHz ±(3.0%+50d), 40Hz~1kHz
Resistance	220Ω/2.2kΩ/22kΩ/220kΩ	0.01Ω/0.0001kΩ/0.001kΩ/0.01kΩ	±(0.5%+10d)
	2.2MΩ	0.0001MΩ	±(0.8%+10d)
	22MΩ	0.001MΩ	±(1.5%+10d)
	220MΩ	0.01MΩ	±(3.0%+50d)
Capacitance	22nF/220nF/2.2μF/22μF	0.001nF/0.01nF/0.0001μF/0.001μF	±(3.0%+5d)
	220μF/2.2mF	0.01μF/0.0001mF	±(4.0%+5d)
	22mF	0.001mF	±(10%+5d)
	220mF	0.01mF	±(20%+5d)
Frequency	10Hz~220MHz	0.01Hz~0.01MHz	±(0.01%+5d)
Duty cycle	0.1%~99.9%	0.1%	±(2.0%+5d)
Transistor hFE	range: 1β~1000β		
Diode test	open circuit voltage: 3V		
Continuity check	<50Ω		
Power supply	4×1.5V AAA batteries		
Dimension	186×89×49mm		
Weight	400g		

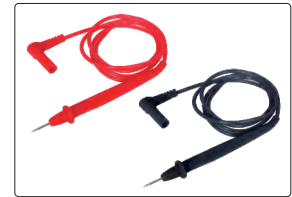
DIGITAL AC/DC CLAMP METER CODE 9315-CF210



test leads (included)

- 4000 counts display
- 28mm jaw opening
- NCV detection with light and sound alarm
- True RMS measurement
- Auto ranging
- REL (zero) function
- Data hold
- Polarity indication
- LCD screen with backlight
- Low battery indication
- Auto power off
- Safety rating: CAT III 300V/CAT II 600V

STANDARD DELIVERY

Main unit	1 pc
Battery (AAA)	2 pcs
Test lead	2 pcs

SPECIFICATION

Function	Range	Resolution	Accuracy ("d" is the least reading)
DC Current	40.00A/400.0A	0.01A/0.1A	±(2.0%+5d)
AC Current *	40.00A/400.0A	0.01A/0.1A	±(2.0%+5d)
DC Voltage	400.0mV	0.1mV	±(0.7%+3d)
	4.000V/40.00V/400.0V/600V	0.001V/0.01V/0.1V/1V	±(0.5%+2d)
AC Voltage *	4.000V	0.001V	±(1.0%+5d)
	40.00V/400.0V/600V	0.01V/0.1V/1V	±(0.8%+5d)
AC Voltage frequency	10Hz~60kHz	0.01Hz~0.01kHz	±(0.5%+2d)
Resistance	400.0Ω	0.1Ω	±(1.0%+2d)
	4.000kΩ/40.00kΩ/400.0kΩ	0.001kΩ/0.01kΩ/0.1kΩ	±(0.8%+2d)
	4MΩ/40MΩ	0.001MΩ/0.01MΩ	±(2.5%+5d)
Capacitance	40.00nF/400.0nF/4.000μF/ 40.00μF/400.0μF	0.01nF/0.1nF/0.001μF/ 0.01μF/0.1μF	±(4.0%+5d)
	4.000mF/40.00mF	0.001mF/0.01mF	±10.0%
Frequency	10Hz~10MHz	0.01Hz~0.01MHz	±(0.1%+4d)
Duty cycle	0.1%~99.0%	0.1%	±(3.0%+5d)
Diode test	open circuit voltage: 4V		
Continuity check	<30Ω		
Power supply	2×1.5V AAA batteries		
Dimension (L×W×H)	215×75×37mm		
Weight	235g		

* AC voltage/current frequency response: 45Hz~400Hz, true RMS display



AC PHASE AND VOLTAGE DETECTOR CODE 9723-400

- Non-contact detection of phase sequence, high and low voltage, wire distinction
- Low battery indication
- Auto power off
- Flashlight

SPECIFICATION

Phase sequence detection	screen shows clockwise or counterclockwise
High and low voltage detection	beep: slow~fast backlight: green~red analog bar: low~high
Wire distinction	green backlight indicates neutral wire red backlight indicates live wire
Power supply	2×1.5V AAA batteries
Dimension	157×27×23mm
Weight	32g



DIGITAL VOLTAGE TESTER CODE 9721-250

- Direct AC test (contact): 12-250V
two way display: voltage displays on LCD screen and neon lamp lights up (when voltage>80V)
- Induction AC test (non-contact): 12-250V
to detect power source or recognize the phase line, ground line and break point
- Direct DC test (contact): 6-36V
instant sense and display
- Work without battery
- Tester tip: CRV material

SPECIFICATION

Range	AC: 12-250V; DC: 6-36V
Neon lamp life	30000 times
Dimension	133×21×19mm
Weight	22g



VOLTAGE TESTER CODE 9722-250

- Tester tip: CRV material

SPECIFICATION

Range	AC: 100-250V
Neon lamp life	30000 times
Dimension	145×Ø15mm
Weight	21g



INTELLIGENT CORDLESS SOLDERING IRON CODE 0710-SD420



soldering tip **0710-SK** (included)



soldering tip **0710-J** (included)



- Built-in lithium battery, easy to carry
- Integral precision soldering tip, fast heating speed
- Automatic sleep function
- Temperature calibration function

soldering tips (included)

Unit: mm

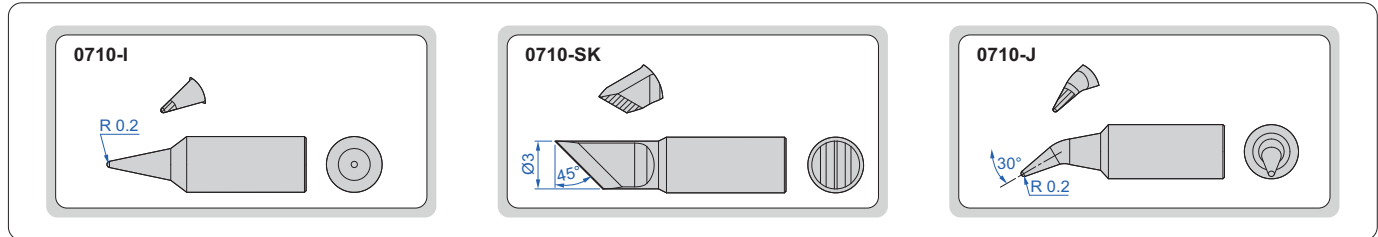

soldering tips (optional)

Unit: mm

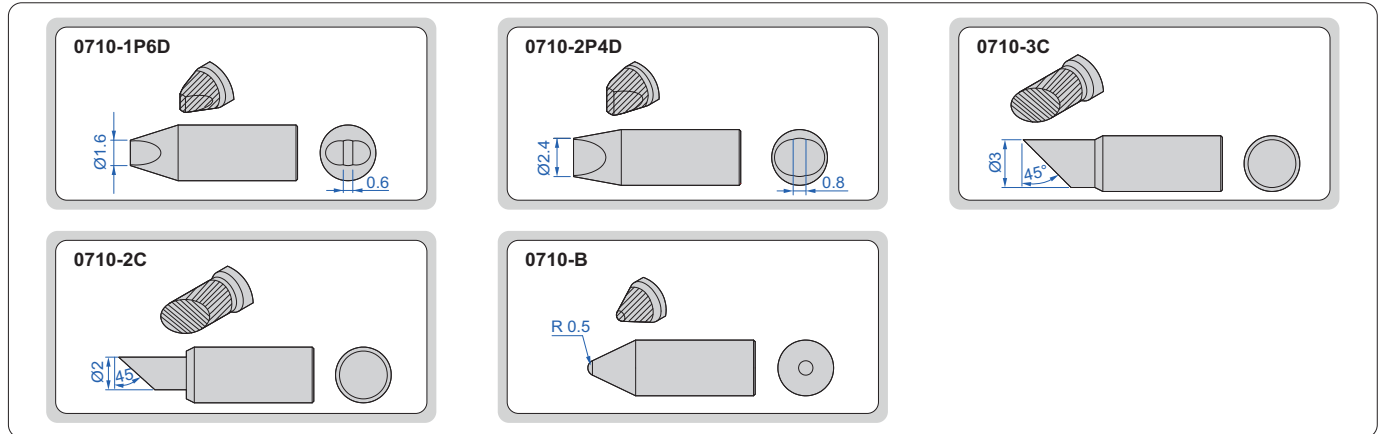

SPECIFICATION

Display screen	OLED
Temperature range	100°C~420°C
Power	10W
Work hours	30 minutes (indicates V-P when the battery is low)
Power supply	rechargeable lithium battery: 3.7V, 2600mAh
Dimension	198×27×21mm
Weight	85g



soldering iron stand (included)

STANDARD DELIVERY

Main unit	1 pc
Soldering tip (0710-I)	1 pc
Soldering tip (0710-J)	1 pc
Soldering tip (0710-SK)	1 pc
Soldering iron stand	1 pc

OPTIONAL ACCESSORY

Soldering tip	0710-1P6D
Soldering tip	0710-2P4D
Soldering tip	0710-3C
Soldering tip	0710-2C
Soldering tip	0710-B



**LEAD FREE SOLDERING STATION
CODE 0711-SS480**

- Fast heat-up and temperature return of the welding table
- Quickly switch between 3 different temperatures
- Temperature calibration function
- Compatible with general-purpose soldering nozzles, easy to use and economical



SPECIFICATION

Display screen	LCD
Temperature range	100°C~480°C
Temperature stability	±2°C (when the air is still and no load)
Power	70W (MAX)
Tip to ground potential	<2mV
Tip to ground resistance	<2Ω
Power supply	AC 220V, 50Hz
Dimension	87×140×119mm
Weight	1.75kg

OPTIONAL ACCESSORY

Soldering tip	0711-0P8D
Soldering tip	0711-1P2D
Soldering tip	0711-2P4D
Soldering tip	0711-3P2D
Soldering tip	0711-LB
Soldering tip	0711-I
Soldering tip	0711-1C
Soldering tip	0711-2C
Soldering tip	0711-3C
Soldering tip	0711-4C
Soldering tip	0711-0P8C
Soldering tip	0711-K
Soldering tip	0711-LI
Soldering tip	0711-SK

STANDARD DELIVERY

Main unit	1 pc
Soldering tip (0711-B)	1 pc
Soldering iron stand	1 pc

soldering tips (included)

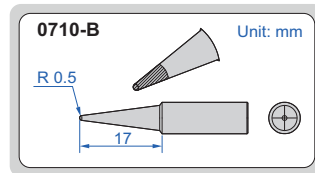

soldering tips (optional)

Unit: mm

<p>0711-0P8D</p>	<p>0711-LB</p>	<p>0711-1C</p>	<p>0711-1P2D</p>
<p>0711-I</p>	<p>0711-2C</p>	<p>0711-2P4D</p>	<p>0711-SK</p>
<p>0711-3C</p>	<p>0711-3P2D</p>	<p>0711-K</p>	<p>0711-4C</p>
<p>0711-0P8C</p>	<p>0711-LI</p>		

39 INTELLIGENT LEAD FREE SOLDERING STATION CODE 0712-SS450



- Fast heat-up and temperature return of the welding table
- Quickly switch between 3 different temperatures
- Temperature calibration function
- Automatic sleep function
- Unit: °C/°F



soldering tip 0712-SK (included)



soldering tip 0712-J (included)



soldering tip 0712-I (included)

soldering iron stand (included)

soldering tips (included)

Unit: mm

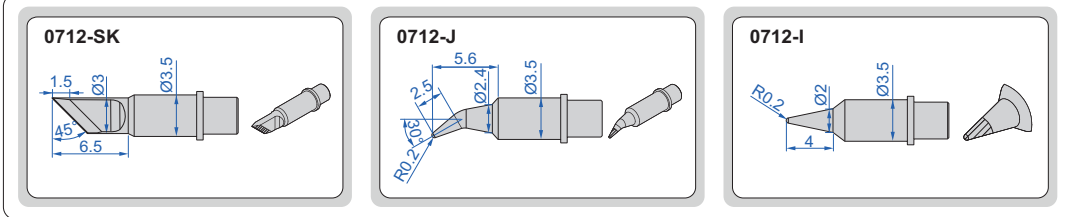

soldering tips (optional)

Unit: mm

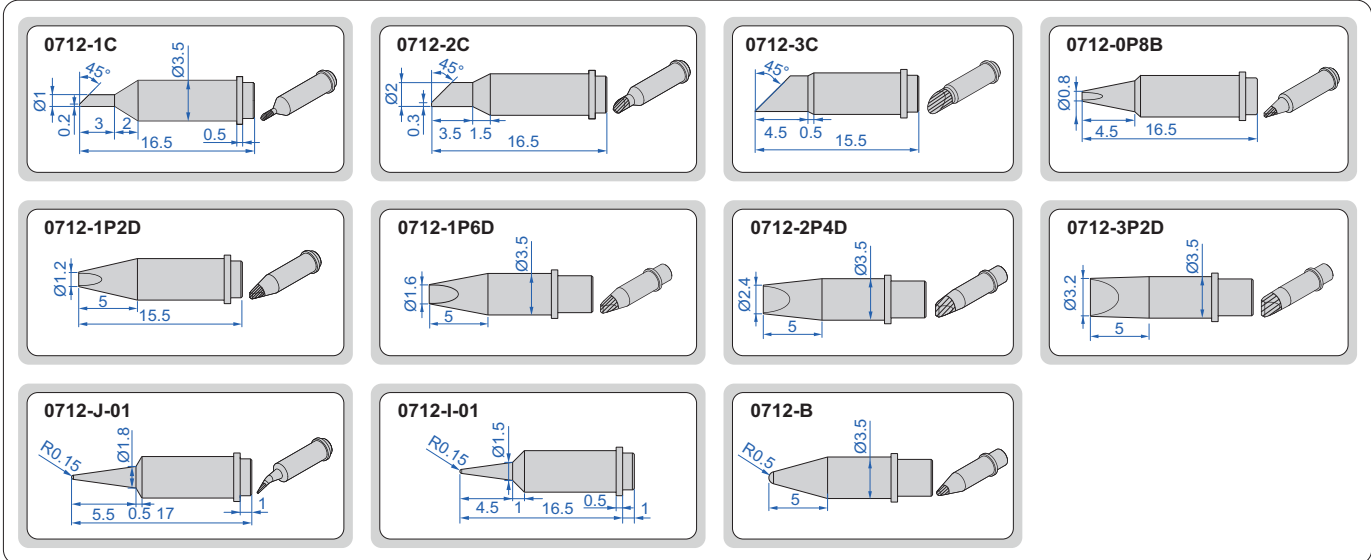

SPECIFICATION

Display screen	IPS
Temperature range	100°C~450°C/212°F~842°F
Temperature stability	±2°C (when the air is still and no load)
Power	90W (MAX)
Tip to ground potential	<2mV
Tip to ground resistance	<2Ω
Power supply	AC 220V, 50Hz
Dimension	116×149×93mm
Weight	1.8kg

STANDARD DELIVERY

Main unit	1 pc
Soldering tip (0712-SK)	1 pc
Soldering tip (0712-J)	1 pc
Soldering tip (0712-I)	1 pc
Soldering iron stand	1 pc

OPTIONAL ACCESSORY

Soldering tip	0712-1C
Soldering tip	0712-2C
Soldering tip	0712-3C
Soldering tip	0712-0P8D
Soldering tip	0712-1P2D
Soldering tip	0712-1P6D
Soldering tip	0712-2P4D
Soldering tip	0712-3P2D
Soldering tip	0712-J-01
Soldering tip	0712-I-01
Soldering tip	0712-B



CODE	PAGE
00	
0010	1131
0011	1130
0012	1132
0020	1087
0021	1088
0022	1086
0030	1085
01	
0110	1128
0111	1129
0120	1092
0130	1134
0131	1133
0132	1134~1135
0140	1127
02	
0213	1110
0215	1111
0216	1111
0218	1112
0222	1110
0231	1107~1108
0232	1108~1109
03	
0310	1123
0311	1119
0312	1124
0313	1122
0314	1124
0315	1123
0316	1121
0317	1120
0319	1121
0320	1117
0321	1113
0322	1117
0323	1116
0324	1118
0350	1114~1115
04	
0410	1145
0411	1138
0412	1137
0413	1139
0414	1140
0420	1099
0430	1143
0431	1142
0432	1141
0434	1144
05	
0501	1100
0502	1101
0522	1098
07	

CODE	PAGE
0701	1103
0710	1213
0711	1214
0712	1215
0716	1204
08	
0811	1149
0815	1150
11	
1102	32
1103	31
1106	42
1108	30
1109	33
1110	35
1111	37
1113	30
1114	31
1117	43
1118	29
1119	33
1120	57
1121	56
1122	72
1123	66
1124	53
1125	50~51
1128	61
1129	61
1130	34
1135	44
1136	43
1138	67
1139	37
1140	93
1141	85
1142	86
1143	89
1144	87
1145	93
1146	325
1147	86
1148	88
1149	85
1150	105
1151	107
1154	108
1155	102
1156	106
1157	103
1158	104
1160	455
1161	76
1162	81
1163	323
1164	72
1165	78
1166	479
1167	81
1168	82
1169	64

CODE	PAGE
1170	36
1171	36
1172	78
1176	58
1177	70
1178	60
1179	76
1180	243
1181	80
1183	65
1184	75
1185	63
1186	75
1187	63
1188	71
1189	238
1191	62
1192	70
1193	34
1195	29
1196	32
1199	59
12	
1201	37
1202	38
1203	37
1204	37
1205	38
1207	44
1208	45
1210	45
1214	46
1215	46
1217	40
1223	39
1224	40
1226	40
1229	74
1233	39
1236	44
1238	39
1239	40
1240	90
1243	92
1244	92
1246	324
1247	90
1248	91
1249	91
1250	109
1251	109
1253	108
1262	58
1267	243
1273	73
1275	478
1281	80
1291	62
13	
1311	41
1312	41

CODE	PAGE
1316	41
1338	67
1339	41
1340	89
1341	89
1351	107
1376	59
15	
1501	239
1520	55
1521	68
1524	71
1525	69
1526	51~52
1527	77
1528	77
1529	74
1530	54
1531	241
1532	66
1533	79
1534	65
1535	64
1536	79
1537	244
1538	82
1539	73
1540	87
21	
2103	251
2104	251
2108	255
2109	256
2112	249
2114	256
2115	253
2116	250
2117	258
2118	257
2121	301
2122	220
2124	212
2126	219
2127	224
2128	222
2130	221
2131	306
2132	307
2133	260
2134	259
2135	262~263
2136	261
2137	255
2138	252
2139	252
2140	264
2141	96
2142	94
2143	97
2144	426
2145	97

CODE	PAGE
2146.....	326
2147.....	325
2149.....	266
2150.....	265
2151.....	302
2152.....	217
2153.....	216
2163.....	323
2164.....	323
2165.....	320
2166.....	322
2167.....	322
2168.....	324
2170.....	545
2171.....	411
2174.....	410
2175.....	543
2176.....	411
2177.....	410
2179.....	543
2182.....	242
2183.....	237
2184.....	321
2186.....	322
2187.....	374
2188.....	236
2189.....	242
2197.....	238
2198.....	544
2199.....	541~542
22	
2222.....	301
2223.....	305
2230.....	332
2231.....	333
2232.....	336
2233.....	335
2234.....	329
2235.....	330
2236.....	341
2237.....	339
2238.....	330
2239.....	331
2240.....	332
2241.....	334
2242.....	336
2243.....	335
2245.....	329
2246.....	340
2247.....	338
2250.....	343
2251.....	342
2252.....	114~115
2253.....	327
2254.....	327
2255.....	337
2256.....	337
2257.....	536
2258.....	536
2259.....	315
2260.....	343
2261.....	342

CODE	PAGE
2262.....	318
2263.....	317
2274.....	475
2275.....	421
2276.....	475
2278.....	476
2280.....	421
2281.....	477
2282.....	477
2283.....	218
2284.....	215
23	
2301.....	267
2302.....	269
2307.....	271
2308.....	267
2309.....	270
2310.....	269
2311.....	267
2313.....	266
2314.....	268
2316.....	271
2318.....	270
2321.....	302
2322.....	220
2324.....	268
2326.....	271
2328.....	269
2332.....	307
2333.....	307
2334.....	304
2335.....	303
2341.....	95
2342.....	95
2343.....	94
2344.....	1048
2348.....	226
2361.....	312
2363.....	313
2364.....	310
2365.....	312
2366.....	310
2367.....	318
2372.....	414
2373.....	414
2374.....	413
2380.....	246
2381.....	246
2383.....	246
2385.....	518
2386.....	247
2394.....	535
2395.....	227
2396.....	279
2397.....	535
2398.....	247
2399.....	247
24	
2480.....	248
25	

CODE	PAGE
2501.....	254
2511.....	237
2530.....	221
26	
2673.....	309
2674.....	311
27	
2710.....	315
2711.....	306
2715.....	234
2716.....	235
2724.....	222~223
2771.....	415
28	
2801.....	268
2824.....	222~223
2825.....	219
2827.....	224
2828.....	222
2841.....	326
2843.....	1048
2844.....	1049
2850.....	309
2852.....	217
2853.....	216
2859.....	320
2862.....	314
2863.....	314
2866.....	314
2870.....	314
2871.....	310
2872.....	311
2873.....	319
2876.....	319
2877.....	313
2878.....	316
2879.....	308
29	
2931.....	112~113
2932.....	116~117
2933.....	119~121
2934.....	118
2935.....	121~123
2962.....	228
31	
3101.....	133
3102.....	135
3108.....	134
3109.....	136
3127.....	208~209
3128.....	210
32	
3202.....	138
3203.....	139~140
3205.....	147
3206.....	144
3208.....	141

CODE	PAGE
3209.....	143
3210.....	140
3216.....	143
3220.....	198
3221.....	199
3222.....	202
3224.....	200
3225.....	202
3226.....	206
3227.....	207~208
3228.....	210
3229.....	200
3230.....	162
3231.....	142
3232.....	166
3233.....	169
3234.....	176
3235.....	148
3236.....	142
3238.....	179
3239.....	175
3240.....	98
3241.....	99
3260.....	172
3261.....	171
3262.....	175
3263.....	185
3264.....	185
3266.....	168
3280.....	178
3281.....	157
3282.....	182
3283.....	180
3285.....	186
3287.....	153
3288.....	174
3290.....	177
3291.....	160
3292.....	185
3293.....	186
3294.....	183
3296.....	153
3297.....	164
33	
3331.....	151
3332.....	150
3333.....	148
3334.....	321
3335.....	321
3338.....	181
3346.....	151
3350.....	131
3351.....	132
3352.....	167
3353.....	184
3354.....	163
3355.....	173
3356.....	170
3358.....	130
3359.....	129
34	

CODE NO. INDEX



CODE	PAGE
3400.....	141
35	
3506.....	145
3507.....	149
3508.....	150
3520.....	199
3521.....	203
3522.....	225
3530.....	162
3532.....	166
3533.....	169
3534.....	176
3538.....	179
3539.....	175
3540.....	98
3560.....	172
3561.....	171
3562.....	176
3565.....	136
3566.....	168
3580.....	178
3581.....	158
3583.....	180
3588.....	174
3590.....	177
3591.....	161
3594.....	183
3597.....	164
36	
3621.....	211
3634.....	203
3635.....	204
3636.....	159
3638.....	205
3641.....	205
3650.....	165
3653.....	174
3658.....	168
3659.....	162
3675.....	146
3676.....	181
3677.....	182
3678.....	199
3679.....	198
3680.....	155
3681.....	138
3682.....	137
3683.....	201
3684.....	201
3685.....	152
37	
3701.....	137
40	
4001.....	357
4002.....	361
4004.....	504
4006.....	503
41	

CODE	PAGE
4100.....	351
4101.....	352
4103.....	350
4104.....	353
4105.....	348
4106.....	349
4107.....	356
4108.....	355
4110.....	365
4111.....	347
4113.....	366
4118.....	365
4120.....	389
4121.....	396
4124.....	375
4128.....	376
4129.....	390~394
4130.....	385
4131.....	395
4139.....	386~388
4141.....	416
4142.....	498
4143.....	502
4144.....	415
4147.....	424
4155.....	505
4157.....	440
4158.....	506
4160.....	356
4164.....	354
4166.....	363
4168.....	381
4169.....	364
4172.....	379
4176.....	355
4177.....	403
4178.....	404~405
4179.....	100
4180.....	424
4184.....	186
4190.....	380
4191.....	425
4192.....	366
4193.....	365
4194.....	362
4198.....	618
4199.....	186
42	
4206.....	229
4208.....	228
4209.....	229
46	
4601.....	445
4602.....	445
4605.....	446
4608.....	446
4621.....	448
4622.....	448
4623.....	447
4624.....	447
4630.....	456

CODE	PAGE
4647.....	397
4649.....	383
4662.....	381
4666.....	384
4676.....	382
4677.....	398~402
4683.....	213~214
47	
4700.....	423
4701.....	421
4702.....	423
4706.....	423
4707.....	420
4710.....	416
4712.....	416
4720.....	438
4721.....	440
4722.....	439
4723.....	436
4725.....	428
4726.....	429
4728.....	439
4731.....	432
4733.....	436
4734.....	431
4735.....	438
4736.....	431
4737.....	430
4738.....	434
4739.....	433
4741.....	435
4745.....	422
4747.....	422
4754.....	423
4760.....	422
4762.....	422
4770.....	417
4771.....	687
4780.....	412
4781.....	412
4782.....	435
4786.....	432
4788.....	437
4789.....	429
4790.....	417
4791.....	418
4792.....	420
4793.....	419
4794.....	418
4795.....	420
4796.....	419
4797.....	413
4799.....	412
48	
4801.....	451
4802.....	452
4803.....	454
4804.....	452
4806.....	451
4807.....	451
4808.....	454

CODE	PAGE
4809.....	454
4810.....	450
4812.....	450
4820.....	449
4824.....	449
4829.....	457
4830.....	458
4831.....	459
4832.....	461
4833.....	456
4834.....	460
4835.....	463
4836.....	461
4837.....	457
4838.....	462
4839.....	464
4840.....	460
4841.....	464
4842.....	453
4843.....	453
4844.....	244
4845.....	1049
4846.....	461
4847.....	462
4848.....	460
4849.....	462
4850.....	459
4851.....	459
4852.....	458
4853.....	455
4854.....	453
4855.....	458
4860.....	450
4865.....	241
49	
4902.....	545
4903.....	547
4905.....	547
4906.....	546
4907.....	547
4908.....	547
4910.....	548
4911.....	550
4912.....	548
4913.....	549
4914.....	550
4917.....	552
4918.....	551
4921.....	549
4922.....	549
4923.....	551
4950.....	546
4952.....	539
50	
5013.....	486
5021.....	481
5022.....	481
5023.....	482
5024.....	482
5031.....	482
5032.....	483

CODE	PAGE
5041.....	483
5042.....	483
5051.....	484
5052.....	484
5061.....	484
5062.....	485
5063.....	485
5064.....	465
5071.....	465
5072.....	465
5081.....	485
5091.....	486
51	
5101.....	741
5102.....	739
5103.....	736
5104.....	742
5106.....	747
5107.....	743
5108.....	737
5109.....	740
5110.....	738
52	
5201.....	1098
5202.....	1097
5203.....	1097
5220-PP06.....	1094
5220-PA-□□□.....	1095~1096
5230.....	1095
5240.....	1093~1094
53	
5301.....	703
5302.....	699
5303.....	700
5305.....	749
5307.....	723
5310.....	709~710
5311.....	731~732
5313.....	704
5314.....	516~517
5315.....	701~702
5316.....	716
5317.....	717~718
5318.....	707~708
5319.....	724
5320.....	697~698
5322.....	721~722
5323.....	691
5324.....	692
5325.....	719~720
54	
5401.....	1041
5402.....	1042~1043
5403.....	1045
5404.....	1046
57	
5700.....	1064
5701.....	1062~1063

CODE	PAGE
5702.....	1050
5704.....	1064
5705.....	1057~1058
5706.....	1055~1056
5707.....	1058~1059
5711.....	1052
5712.....	1051
5721.....	1054
58	
5801.....	1147
5802.....	1148
5803.....	1148
5804.....	1102
5805.....	1103
5806.....	1146
5808.....	1147
59	
5900.....	983
5910.....	983
61	
6140.....	48
6141.....	92
6143.....	64
6144.....	48
6145.....	49
6146.....	49
62	
6200.....	285
6201.....	285
6202.....	285
6207.....	287
6210.....	283
6211.....	286
6212.....	286
6214.....	287
6215.....	286
6216.....	286
6217.....	287
6219.....	282
6221.....	284
6224.....	284
6225.....	289
6226.....	288
6227.....	289
6228.....	284
6229.....	282
6230.....	288
6231.....	285
6250.....	336
6251.....	330
6252.....	334
6253.....	331
6254.....	343
6255.....	337
6272.....	283
6282.....	272~276
6284.....	248
6291.....	281
6293.....	280

CODE	PAGE
6294.....	281
6295.....	281
6296.....	280
6297.....	280
6298.....	248
63	
6300.....	189
6301.....	189
6302.....	188
6307.....	192
6309.....	47
6310.....	190
6312.....	370
6315.....	188
6316.....	373
6317.....	371
6318.....	191
6319.....	372
6331.....	377
6332.....	378
6333.....	377
6335.....	441
6341.....	378
6342.....	379
6353.....	192
6354.....	192
6372.....	193
6373.....	193
6375.....	196
6377.....	195
6381.....	195
6384.....	194
6385.....	193
6386.....	194
6387.....	194
6388.....	196
6389.....	195
6391.....	437
6392.....	437
65	
6509.....	500
6511.....	500
6512.....	501~502
6513.....	507
6516.....	509
6519.....	510
6520.....	508
6521.....	509
6523.....	507
6524.....	508
6525.....	508
6526.....	509
6527.....	506
6528.....	510
6531.....	503
6533.....	500
6534.....	502
6535.....	504
6536.....	506
6537.....	499
6538.....	507

CODE	PAGE
6539.....	498
6540.....	362
6542.....	499
6547.....	504
6548.....	505
6549.....	505
6553.....	534
6554.....	534
6555.....	535
6556.....	534
6557.....	534
6558.....	522
6562.....	521
6566.....	520
6567.....	521
6568.....	521
6571.....	519
6572.....	519
6573.....	520
6582.....	511
6583.....	514
6584.....	512
6585.....	513
6586.....	513
6587.....	513
6588.....	514
68	
6801.....	496
6802.....	492
6803.....	492
6804.....	493
6805.....	494
6806.....	493
6832.....	463
6841.....	290
6842.....	297
6843.....	125
6844.....	124
6845.....	295
6846.....	296
6847.....	126
6852.....	426
6861.....	293
6862.....	293
6863.....	292
6864.....	292
6865.....	298
6866.....	290
6867.....	291
6868.....	294
6869.....	295
6870.....	291
6874.....	621
6875.....	582
6876.....	290
6877.....	294
6878.....	497
6879.....	503
6880.....	100
6881.....	358
6882.....	619~620
6883.....	359



CODE	PAGE
6884.....	360
6885.....	618
6886.....	359
6887.....	494
6888.....	494
6889.....	495
6890.....	496
6891.....	497
6896.....	491
6897.....	495
6898.....	491
69	
6900.....	489
6902.....	490
6903.....	490
6990.....	480
71	
7100.....	474
7101.....	575
7102.....	576
7106.....	563
7107.....	564
7107-1□□□.....	562
7110.....	473
7111.....	425
7113.....	472
7114.....	231
7117.....	424
7118.....	425
7119.....	473
7120.....	478
7123.....	473
7130.....	555~556
7131.....	561
7133.....	565~566
7134.....	557~558
7135.....	230
7136.....	231
7137.....	229
7138.....	560
7139.....	471
7140.....	469
7142.....	469
7143.....	471
7144.....	471
7145.....	472
7146.....	472
7147.....	469
7148.....	470
7149.....	470
7150.....	110
7160.....	771
7161.....	772
7162.....	771
7163.....	772
72	
7202.....	479
7203.....	479
7205.....	478
7210.....	24~25

CODE	PAGE
7212.....	559
7213.....	13~14
7214.....	11~12
7215.....	23
7230.....	480
7231.....	480
7232.....	480
7240.....	466
7241.....	466
7247.....	467
7260.....	467
7261.....	466
7262.....	467
73	
7302.....	20~22
7304.....	27
7305.....	16~19
7315.....	5~10
7317.....	2~4
7321.....	206
7324.....	26
7325.....	26
7327.....	27
7330.....	278
7331.....	277
7332.....	277
7333.....	277
7338.....	481
7340.....	366
7341.....	368
7342.....	367
7344.....	369
7345.....	367
7350.....	227
7351.....	226
7353.....	227
7360.....	257
7377.....	328
7381.....	159
7382.....	154
7383.....	160
7384.....	156
7385.....	206
7386.....	190
7390.....	156
7391.....	161
7394.....	154
75	
7511.....	767
7512.....	770
7513.....	769
7514.....	767
7515.....	767
7516.....	764
7517.....	764
7520.....	764
7521.....	764
7522.....	769
7523.....	770
7524.....	767
7525.....	765

CODE	PAGE
7526.....	766
7527.....	768
7528.....	768
7529.....	769
7530.....	771
76	
7600.....	1090
79	
7901.....	27
80	
8001.....	1168
8002.....	1168
8003.....	1169
81	
8101.....	1169
8102.....	1164
8103.....	1165
8106.....	1166
82	
8201.....	1175
8202.....	1175
8203.....	1177
8204.....	1176~1177
8205.....	1178~1179
8206.....	1179
8207.....	1180
8290.....	1181
83	
8301.....	1157
8303.....	1155
8304.....	1154
8305.....	1158
8306.....	1159
8307.....	1160
8308.....	1161
8309.....	1162~1163
8310.....	1153
8319.....	1156
8390.....	1185
84	
8401.....	1173
85	
8501.....	1171
8502.....	1172
8503.....	1172
86	
8601.....	1170
8602.....	1170
8603.....	981
8604.....	1181
8650.....	980
87	
8701.....	1167

CODE	PAGE
88	
8801.....	1174
89	
8910.....	1183
8911.....	1182
8912.....	1184
8913.....	1184
8914.....	1185
91	
9132.....	1106
92	
9215.....	1210
9216.....	1206
9219.....	1209
9223.....	1083
9224.....	1084
9225.....	1083
9241.....	1205
9242.....	1207
9246.....	1208
9247.....	1207
93	
9315.....	1211
9341.....	1092
9351.....	1131
9353.....	1132
9362.....	1122
94	
9401.....	795
9408.....	797
9410.....	523
9411.....	533
9412.....	532
9413.....	526~527
9414.....	528~529
9415.....	530~531
9416.....	796
9420.....	555
9426.....	524~525
9440.....	798
9452.....	1204
9453.....	1202
9454.....	1203
9460.....	1201
95	
9501.....	1040
9503.....	1047
9511.....	1054
9530.....	1194
9561.....	1088
9563.....	468
9564.....	1089
9565.....	1090
96	
9643.....	874

CODE	PAGE
9646.....	851~852
9650.....	1198
9651.....	1196
9652.....	1200
9653.....	1199
9654.....	1197
9670.....	1195
97	
9710.....	1060~1061
9720.....	1087
9721.....	1212
9722.....	1212
9723.....	1212
99	
9914.....	1205
ALT	
ALT-P150.....	794
ATM	
ATM.....	1005
AVIM	
AVIM.....	813~814
CMM	
CMM-BE□□□.....	613~615
CMM-CM□□□.....	613~615
CMM-HP□□□.....	613~615
CMM-LE□□□.....	611~612
CMM-LM□□□.....	611~612
CMM-PE□□□.....	607~610
CMM-PM□□□.....	607~610
CSA	
CSA-R300.....	938
CST	
CST-D101.....	877
CST-D102.....	877
DBC	
DBC-M660.....	1126
DSW	
DSW-A010.....	1091
DSW-B024.....	1091
ECT	
ECT-S610.....	898
EDV	
EDV-AC1100.....	1191~1192
EDV-AC2400.....	1191~1192
EDV-AC3000.....	1191~1192
EDV-AC4000.....	1191~1192
EDV-AC5000.....	1191~1192
EMU	
EMU-A100.....	1073
EMU-B100.....	1073

CODE	PAGE
EMU-S340.....	1072
EST	
EST.....	912~913
FTI	
FTI-A170.....	937
GCT	
GCT-2400.....	939
GCT-3600.....	940~941
GRL	
GRL-L340.....	553
HDT	
HDT-AMV338.....	836~837
HDT-AVH05.....	842~843
HDT-AVH10.....	842~843
HDT-AVH30.....	842~843
HDT-AVH50.....	842~843
HDT-B-□□□.....	875~876
HDT-B430.....	859
HDT-BRV330.....	846~847
HDT-CB320.....	853~854
HDT-CRS200.....	819~820
HDT-DB337.....	869
HDT-DM290.....	821~822
HDT-DM300.....	821~822
HDT-DM310.....	821~822
HDT-DMV90.....	834~835
HDT-ESA.....	870
HDT-ESD.....	870
HDT-ES-STD.....	870
HDT-L301.....	861
HDT-L410.....	858
HDT-L411.....	860
HDT-LP200.....	857
HDT-LP200B.....	857
HDT-MB325.....	849
HDT-MB326.....	849
HDT-MB610.....	845
HDT-MB710.....	845
HDT-MBE320.....	844
HDT-MVE1300.....	832
HDT-MVH1100.....	833
HDT-PB350.....	865
HDT-RA151.....	827
HDT-RH411.....	829
HDT-RM421.....	828
HDT-RT151.....	823~824
HDT-RT152.....	823~824
HDT-RT153.....	823~824
HDT-RW160.....	831
HDT-ST300.....	825~826
HDT-ST310.....	825~826
HDT-ST320.....	825~826
HDT-VE03.....	838~839
HDT-VE14.....	838~839
HDT-VE35.....	838~839
HDT-VE56.....	838~839
HDT-VH05.....	840~841
HDT-VH11.....	840~841

CODE	PAGE
HDT-VH31.....	840~841
HDT-VH51.....	840~841
HDT-WL320.....	853~854
HDT-WP201.....	856
HES	
HES-E□□□.....	1002~1003
HES-S□□□.....	1004
HHL	
HHL-R240.....	919
HHL-S360.....	920
HLC	
HLC-3000.....	942~944
HLS	
HLS-B410.....	917~918
HSM	
HSM-A310.....	916
HTT	
HTT-A150.....	1190
IPT	
IPT-ZP1300.....	910
ISBR	
ISBR-H181.....	864
ISD	
ISD-CL□□□.....	674
ISD-E320.....	659~660
ISD-E430.....	659~660
ISD-F432.....	655~657
ISD-H210.....	663~664
ISD-H320.....	663~664
ISD-H430.....	663~664
ISD-LF.....	816
ISD-R320.....	658~659
ISD-R430.....	658~659
ISD-R540.....	658~659
ISD-TD1.....	815
ISD-TD2.....	815
ISD-TD3.....	815
ISD-TM215.....	695~696
ISD-TM320.....	695~696
ISD-TM330.....	695~696
ISD-TM430.....	695~696
ISD-U322.....	652~653
ISD-U432.....	652~653
ISD-U532.....	652~653
ISD-U542.....	652~653
ISD-V150A.....	664~665
ISD-V220□□□.....	661~662
ISD-V250A.....	664~665
ISD-V270□□□.....	661~662
ISD-V300A.....	664~665
ISD-V370□□□.....	661~662
ISD-V400A.....	664~665
ISD-V500HN.....	667~668
ISD-V500N.....	667~668

CODE	PAGE
ISD-V501HN.....	667~668
ISD-V501N.....	667~668
ISD-VMM□□□.....	693~694
ISD-W3150.....	654
ISD-Y□□□.....	665~666
ISE	
ISE-2DT.....	540
ISE-DF10.....	799~800
ISE-L051.....	538
ISE-L051L.....	538
ISF	
ISF-1DF□□□.....	973
ISF-DF□□□.....	971
ISF-DFAT1.....	972
ISF-DFAT2-C1.....	972
ISF-DFAT2-C3.....	972
ISF-DFAT2-C2.....	972
ISF-DFAT2-C4.....	972
ISF-DG1.....	999
ISF-DG2.....	999
ISF-DG3.....	999
ISF-DG4.....	999
ISF-DGD15.....	187
ISF-DGD50.....	187
ISF-DT□□□.....	982
ISF-F□□□.....	974
ISF-H20A.....	977
ISF-H20D.....	977
ISF-MH2.....	978
ISF-MT1K.....	973
ISF-MT500.....	974
ISF-P□□□.....	975
ISF-P30A.....	978
ISF-P30D.....	978
ISF-RH62.....	976
ISF-RV61.....	976
ISF-S□□□.....	970
ISF-TG□□□.....	981
ISF-V10A.....	977
ISF-V10D.....	977
ISF-YT□□□.....	979
ISGF	
ISGF-0501.....	480
ISGF-0901.....	480
ISH	
ISH-BL01.....	850
ISH-BRV.....	848
ISH-DSA.....	871
ISH-DSD.....	871
ISH-DSOO.....	871
ISH-DS-STANDA.....	872
ISH-OS2.....	873
ISH-PHB-B.....	855
ISH-PH-SP9.....	862
ISH-R150.....	830
ISH-S30A.....	872
ISH-S30D.....	872
ISH-SAM.....	873
ISH-SDM.....	873



CODE	PAGE
ISH-ST02	850
ISH-STAC	874
ISH-STD	874
ISHB	
ISHB-B300	869
ISHB-C161	866
ISHB-H131	866
ISHB-P101	865
ISHR	
ISHR-B141	863
ISHR-D121	862
ISHR-M111	863
ISHR-P151	864
ISHW	
ISHW-B000	867
ISHW-D000	868
ISHW-H000	868
ISHW-L000	867
ISL	
ISL-A1000	568~569
ISL-A5000	568~569
ISL-B5000	568~569
ISL-C1000	569~570
ISL-C5000	569~570
ISL-DR2	571
ISL-DR3	571
ISL-LCD7	572
ISM	
ISM-AD-0D	763
ISM-AD-A0D5	763
ISM-AD-0D75	763
ISM-AD-A0D75	763
ISM-CM20	757~758
ISM-CM63	754~755
ISM-CT820	684
ISM-DF80	751~752
ISM-DL300	705~706
ISM-DL301	705~706
ISM-DL302	711
ISM-DL400	725~726
ISM-DL510	714~715
ISM-DL520	712~713
ISM-DL-COAXIAL	729
ISM-DL-LED	729
ISM-DL-OB000	730
ISM-DL-STAGE1	728
ISM-H5000	689~690
ISM-KM60	755~756
ISM-LED-100L4	728
ISM-LED-9245R	728
ISM-LED-BRACKET	729
ISM-LED-CTRL	728
ISM-MAS100	761~762
ISM-MP8B	759~760
ISM-MV10	756
ISM-PM20	763
ISM-PM40	763
ISM-PM50	763

CODE	PAGE
ISM-PM100	763
ISM-PM200SA	733
ISM-PM200SB	733
ISM-POL1000	750
ISM-WF200	734~735
ISM-ZS100	745
ISM-ZS100T	745
ISM-ZS200	744
ISM-ZS30	748
ISM-ZS50	746
ISM-ZS50T	746
ISM-ZS70-S	753
ISM-ZS-LED	729
ISO	
ISO-1000FN	1043
ISO-1200FN	1044
ISO-8000FN	1039
ISP	
ISP-A1000E	630~631
ISP-A3000E	636~637
ISP-A350	676~677
ISP-A000	632~633
ISP-A6000	640~641
ISP-A6000E	640~641
ISP-A7000E	638~639
ISP-AZ3010	634~635
ISP-AZ3020	634~635
ISP-AZ3025	634~635
ISP-AZ3030	634~635
ISP-AZ3040	634~635
ISP-B420	678~679
ISP-W3020	636~637
ISP-W4025	638~639
ISP-Z3015	630~631
ISQ	
ISQ-16-000	617
ISQ-20-000	616~617
ISQ-25-000	616~617
ISQ-30-000	616~617
ISQ-35-000	616~617
ISQ-40-000	616~617
ISQ-45-000	616~617
ISQ-50-000	616~617
ISQ-55-000	616~617
ISQ-DG6	1050
ISQ-DG8	1053
ISQ-DRM31	1147
ISQ-PB000	1067
ISQ-RM10	1148
ISQ-RM30	1148
ISQ-RM80	1148
ISQ-TE100	407~408
ISQ-TS120K	1084
ISQ-ULM000	807~808
ISR	
ISR-C002	595~596
ISR-C003	603
ISR-C200	593~594
ISR-C300	597~599

CODE	PAGE
ISR-CS3000	604
ISR-CS017	605
ISR-CS018	605
ISR-CS130-W	603
ISR-CS2	604
ISR-LS000	605
ISR-RS000	605
ISR-T120	600~602
IST	
IST-04TT000	992
IST-06TS1100	994
IST-06TS2000	994
IST-06TS350	994
IST-07TS3000	995
IST-11WM000	1027~1028
IST-12W30A	1009
IST-12W135A	1009
IST-12W200A	1009
IST-12W340A	1009
IST-13W000	1010
IST-15W000	1008
IST-16W000	1017~1018
IST-17W000	1007
IST-18W000	1011~1012
IST-19WM000	1021
IST-1W000	1015
IST-21W30A	1020
IST-21W135A	1020
IST-21W200A	1020
IST-21W340A	1020
IST-24W000	1020
IST-25WM000	1021~1022
IST-28WM000	1023
IST-29WM000	1024~1025
IST-2SD50	1001
IST-2SD200	1001
IST-2SD400	1001
IST-2SD600	1001
IST-2W000	1013~1014
IST-30WM000	1026
IST-31WM1500	1029
IST-31WM2000	1029
IST-31WM3000	1029
IST-32WM1500	1029~1030
IST-32WM2000	1029~1030
IST-32WM3000	1029~1030
IST-3SD50	1000
IST-3SD200	1000
IST-3SD400	1000
IST-3SD600	1000
IST-4W000	1016
IST-5W30A	1034
IST-5W135A	1034
IST-5W200A	1034
IST-5W340A	1034
IST-9WM000	1026
IST-DCT2	990
IST-DCT5	990
IST-DCT10	990
IST-DCT20	990
IST-DT000	1037
IST-DTT000	989

CODE	PAGE
IST-DW000	1032
IST-HP000	991
IST-IR000	996
IST-MG100	1001
IST-MG250	1001
IST-MG360	1001
IST-MG600	1001
IST-NJ000	998
IST-PW000	1031
IST-S-000	1032~1033
IST-SD200	1000
IST-SD400	1000
IST-SD50	1000
IST-ST000	1036~1037
IST-TA000	997
IST-TM000	1035
IST-TT000	993
IST-W000	1019
IST-WP12	1006
IST-WP20	1006
IST-WP6	1006
IST-WS000	1006
ISU	
ISU-100D	1081
ISU-250C	1080
ISU-300D	1079
ISU-700D	1078
ISU-710D	1077
ISU-720D	1076
ISU-800D	1074
ISU-810D	1075
ISU-PB3	910
ISU-PB5	910
ISU-S000	1082
ISV	
ISV-1H000	790
ISV-1HLED	791
ISV-1LED1	792
ISV-2CAM	791
ISV-CF5	789
ISV-E30	786
ISV-E40	785
ISV-H000	792
ISV-J000	783~784
ISV-K000	780~781
ISV-L	776~778
ISV-P6	784
ISV-S	778~779
ISV-U000	781~782
ISV-Y	774~775
ISY	
ISY-100	626~627
ISY-200	622
ISY-300	624
ISY-400	625
ISY-500	623
ISY-600	628
ISY-700	673
ITM	

CODE	PAGE
ITM-B□□□	964
ITM-S□□□	960~961
ITM-T□□□	962~963
ITM-UV□□□	965
ITM-U32	965
LDM	
LDM-030	801~802
LDM-065	801~802
LDM-090	801~802
LDM-AT01	804~805
LDM-D090	803
LDM-H02	806
LDM-RF001-B	806
LDM-RF001-K	806
LDM-RF001-P	806
LDS	
LDS-N□□□	567
LSK	
LSK-A□□□	573
LSK-B□□□	574
LSK-C□□□	574
LSK-E□□□	573
MLP	
MLP-10□□□	893
MLP-20□□□	893
MLP-30□□□	893
MLP-40□□□	893
MLP-50□□□	893
MLP-60□□□	893
MLP-ACM160	879
MLP-CM□□□	895
MLP-CM60	881
MLP-CM86	882
MLP-DL□□□	896
MLP-DQ□□□	893
MLP-DR□□□	894
MLP-GP260	886
MLP-GP270	887
MLP-GP280	887
MLP-GP305	885
MLP-GP314	888
MLP-GP406	883
MLP-GP505	884
MLP-HCM102	880
MLP-MP25	892
MLP-MP30	891
MLP-MP43	890
MLP-MP53	890
MLP-MP62	891
MLP-OL□□□	894
MLP-PLD101	889
MLP-PLD101S	889
MLP-QM□□□	895
MLP-QP1	896
MLP-QP2	896
MLP-RA	896
MPI	
MPI-CC20	911

CODE	PAGE
MPI-CP30	911
MPI-CX50	905
MPI-FX□□□	906
MPI-HD130	907
MPI-HF360	908
MPI-HW369	908
MPI-M510-B	905
MPI-M510-K	905
MPI-M510-P	905
MPI-MTU3	907
MPI-P110	904
MPI-P220	904
MPI-P330	904
MPI-SC608	909
MSS	
MSS-AL□□	935~936
MSS-CU□□	935~936
MSS-FE□□	935~936
MSS-P□□□	934
OES	
OES-MY100	936
OES-P200	928~930
OES-R420	921~923
OES-T350	924~927
OPP	
OPP-GZ01	811
OPP-OM53	812
PHT	
PHT-C751	1066
PIC	
PIC-D155	1113
PPF	
PPF-BF62	1068
PPS	
PPS-A203	1068
QMS	
QMS-A110	648~649
QMS-A200	648~649
QMS-A220	646~647
QMS-A315	646~647
QMS-A320	646~647
QMS-A450	642~643
QMS-B530	650~651
QMS-H210	644~645
QMY	
QMY-AP32	1066
RCT	
RCT-300	578~579
RCT-RA260	580~581
RFS	
RFS-BT□□□	984~985
RFS-CAT□□□	984~985

CODE	PAGE
RFS-HSK□□□	984~985
RFS-SK□□□	984~985
RXT	
RXT-BM301	912
RXT-F290	911
SCX	
SCX-DMM72	810
SFT	
SFT-□□□	1187
SPM	
SPM-1000	583~584
SPM-2000	585~586
SPM-4000	591~592
SPM-5000	587~588
SPM-6000	589~591
SPT	
SPT-AD21	1065
STM	
STM-A05	967
STM-A10	967
STM-A30	967
STM-B1	968
STM-C1	966
TCM	
TCM	406
TGI	
TGI	405
THD	
THD-PF34	1069
THL	
THL-A01	1125~1126
THT	
THT-A□□□	1189
THT-Z158	1188
TLP	
TLP-300H	683
TLP-300HP	683
TLP-400E	682
TLP-400EP	682
TLP-C500	680
TLP-D150	685~686
TLP-P340B	681
TSA	
TSA-B33	809
TSM	
TSM-C11E	1151
UFD	
UFD-CS1-5	903

CODE	PAGE
UFD-CSK-2A	903
UFD-P710	899~900
UFD-T680	901~902
UTM	
UTM-E□□□	947~948
UTM-EX□□□	955
UTM-F□□□	958~959
UTM-H□□□	954~955
UTM-M□□□	956~957
UTM-S□□□	953
UTM-SC□□□	969
UTM-TT□□□	987~988
UTM-X□□□	950~951
UTM-Z□□□	952
UTT	
UTT-M□□□	949
VMM	
VMM-L□□□	669~670
VSP	
VSP-201	787~788
XRF	
XRF-B210	932~933
XRF-PT230	931

APPLICATION INDEX OF MEASURING TOOLS

SHAFT DIAMETER



Dial Snap Gauges
2186-
(page 322)



Adjustable Snap Gauges
2187- (page 374)



Indicating Micrometers
3332-, 3333-, 3508-, 3307-
(page 148-150)



Micrometers With Dial Indicator
3296-, 3331-, 3346-, 3685-
(page 151-153)



Dial Snap Gauges
3335-, 3334-
(page 321)



Outside Micrometers
(page 133-143)



Universal Calipers
1125-
(page 50-51)

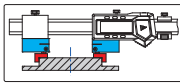

Digital/Dial/Vernier Calipers
(page 29-46)



External Caliper Gauges
2131-, 2333-, 2332-, 2132-
(page 306-307)



Circumference Meters
(page 231)



Internal And External Diameter Comparison Instruments
6844-, 6843-
(page 124-125)



EXTERNAL GROOVE DIAMETER

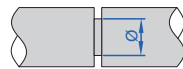

Digital Blade Calipers
1188-, 1532-
(page 71/66)

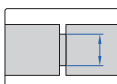

Blade Micrometers
3232-, 3532-, 3650-
(page 165-166)

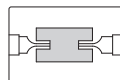

High Precision Digital Blade Micrometers/Snap Gauges
3352-
(page 167)

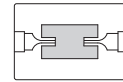

Digital Outside Neck Calipers
1187-, 1185-, 1535-
(page 63-64)

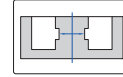

Digital Calipers With Interchangeable Points
1526-, 1124-, 1530-
(page 51-54)

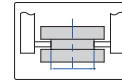

Universal Calipers
1125-
(page 50-51)

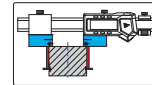

Carbon Fiber Comparison Gauges
2931-
(page 112-113)



Comparison Gauges
2252-
(page 114-115)



External Measuring Gauges
2934-, 2935-
(page 118/121-123)



External Caliper Gauges
2131-, 2333-, 2332-, 2132-
(page 306-307)



Outside Calipers
7262-, 7241-
(page 466-467)



ARC RADIUS

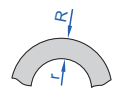

Outside Diameter Variation Measuring Instruments
2715-
(page 234)



Outside Diameter Measuring Instruments
2716-
(page 235)



Digital Radius Gauges
2183, 2197, 2511
(page 237-238)

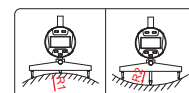

APPLICATION INDEX OF MEASURING TOOLS

Digital Radius Gauges

2188-, 1501-
(page 236/239)

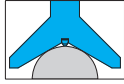

Bore Plug Gauges

4683-
(page 213-214)



Digital Arc Radius Calipers

1189-
(page 238)

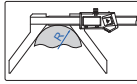

Bore Gauges

(page 215-226)



Radius Gauges

4801-, 4804-, 4802-
(page 451-452)



Carbon Fiber Bore Gauges

3522-
(page 225)



BORE DIAMETER



Digital/Dial/Vernier Calipers With Internal Measuring Jaws

(page 29-46)

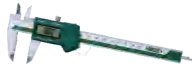

Telescoping Gauges

4208-, 4206-, 4209-
(page 228-229)



Universal Calipers

1125-
(page 50-51)

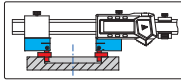

Inside Calipers

7261-, 7240-
(page 466)



Internal Caliper Gauges

(page 301-306)



Carbon Fiber Comparison Gauges

2931-
(page 112-113)



Taper Bore Gauges

4852-, 4855-
(page 458)



Comparison Gauges

2252-
(page 114-115)



Pin Gauges

(page 362-366)



Internal Measuring Gauges

2932-, 2933-
(page 116-117/119-121)



Plain Plug Gauges

(page 375-378)



Taper Gauges

4833-, 4837-
(page 456-457)



Digital Inside Knife-Edge Calipers

1123-, 1138-
(page 66-67)

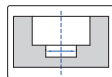

Internal And External Diameter Comparison Instruments

6844-, 6843-
(page 124-125)



DIAMETER OF GROOVE INSIDE HOLES

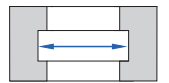

Inside Micrometers

3220-, 3520-, 3679-, 3678-
(page 198-199)



Universal Calipers

1125-
(page 50-51)

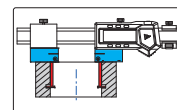

Three Points Internal Micrometers

(page 207-211)



Carbon Fiber Comparison Gauges

2931-
(page 112-113)



Pistol Grip Three Points Bore Gauges

2124-
(page 212)



Tubular Inside Micrometers

(page 199-204)



Comparison Gauges

2252-
(page 114-115)



APPLICATION INDEX OF MEASURING TOOLS

Carbon Fiber Bore Gauges
3522-
(page 225)



External Measuring Gauges
2934-, 2935-
(page 118/121-123)



Digital Calipers With Interchangeable Points
1526-, 1124-, 1530-
(page 51-54)



Inside Groove Calipers
(page 55-62)



Accessory Sets For Digital Calipers
6144-, 6145-, 6146-
(page 48-49)



Internal Caliper Gauges
(page 301-306)



WIDTH AND POSITION OF GROOVE INSIDE HOLES



Digital Hook Calipers
1122-
(page 72)



Digital External Hook Calipers
1164-
(page 72)



Depth Gauges With Hook
1142-, 1144-
(page 86-87)
1540-, 1248-, 1243-
(page 87/91-92)

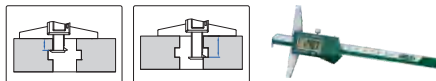

Digital Depth Gauges With Round Depth Bar
1148-
(page 88)

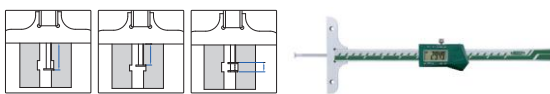

Groove Micrometers
3287- (page 153)

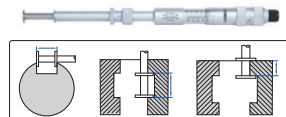

Digital Groove Gauges
2145-
(page 97)

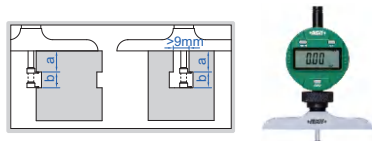

Digital Groove Measurement Stands
6870-
(page 291)



DIAMETER OF BORE WITH CHAMFER

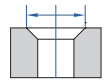

Internal Chamfer Gauges
2962-
(page 228)

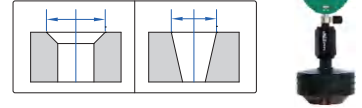

CHAMFER

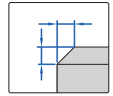

Chamfer Gauges
4844-, 1180-, 1267-
(page 243-244)



Digital Chamfer Gauges
1537-
(page 244)



TUBE WALL THICKNESS

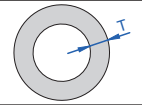

Ultrasonic Thickness Gauges
(page 1072-1081)



Digital Tube Thickness Calipers
1161- (page 76)



Cylindrical Anvil Tube Micrometers
3261-, 3561-
(page 171)



Spherical Anvil Tube Micrometers
3260-, 3560-, 3355-
(page 172-173)



Tube Thickness Gauges
2876-, 2367-, 2859-, 2873-
(page 318-320)

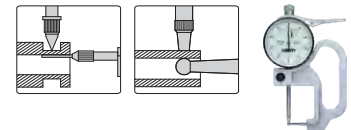

HEIGHT

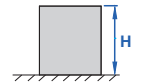

Digital Height Gauges
1155-, 1157-, 1158-
(page 102-104)



Height Gauges
(page 105-109)



APPLICATION INDEX OF MEASURING TOOLS

Dial Indicator Stands
(page 290-297)



Thickness Gauges
(page 308-315)



Transfer Stands
6865-
(page 298)



Digital Snap Gauges
2166-, 2167-, 2163-, 1163-
(page 322-323)



Mini Digital Height Gauges
1146-, 1246-
(page 324-325)

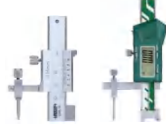

External Caliper Gauges
2131-, 2333-, 2332-, 2132-
(page 306-307)



SHAFT DIAMETER INSIDE HOLE

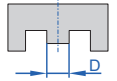

Digital/Dial Height Gauges
2147-, 2146-
(page 325-326)



Caliper Type Micrometers
3238-, 3538-
(page 179)



DEPTH



Depth Gauges
(page 85-87)



Jaw Type Micrometers
3283-, 3583-
(page 180)



Depth Gauges With Point
1143-
(page 89)

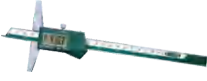
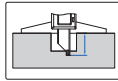

Digital Outside Neck Calipers
1187-, 1185-, 1535-
(page 63-64)



Depth Gauges With Hook
1142-, 1144- (page 86-87)
1540-, 1248-, 1243-
(page 87/91-92)

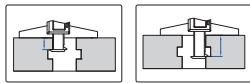

Comparison Gauges
2252-
(page 114-115)



Digital Depth Gauges With Round Depth Bar
1148- (page 88)

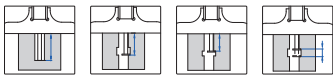

Mini Depth Gauges
1244-, 1145-, 1140-
(page 92-93)



External Measuring Gauges
2934-, 2935-
(page 118/121-123)



SLOT WIDTH

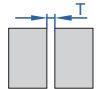

Digital Gap Gauges
ISE-DF10
(page 799-800)



Dial/Digital Depth Gauges
(page 94-97)



Taper Gauges
4833-, 4837-
(page 456-457)



Depth Micrometers
3540-, 3240-, 3241-
(page 98-99)



Taper Slot Gauges
1160-, 4630-
(page 455-456)



Digital/Dial/Vernier Calipers
With Depth Bar
(page 29-46)



Internal Caliper Gauges
(page 301-306)



THICKNESS

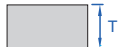

Feeler Gauges
(page 445-447)



APPLICATION INDEX OF MEASURING TOOLS

Step And Gap Gauges

2168-
(page 324)

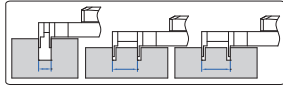

Angle Gauge Blocks

4002-, 6540-
(page 361-362)



Groove Micrometers

3287- (page 153)

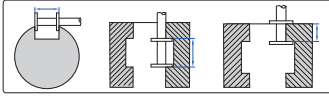

Digital Levels And Slope Meters

(page 541-545)

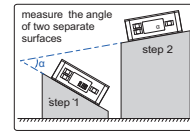

HOLE CENTER-TO-CENTER AND CENTER-TO-EDGE DISTANCE

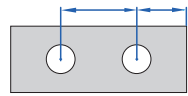

Digital Centering Calipers

(page 68-71)



Universal Calipers

1125-
(page 50-51)

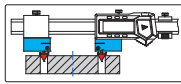

STRAIGHTNESS AND FLATNESS

Straight Edges

(page 423-425)



Straightness/Flatness Gauges

2144-
(page 426)



Flatness Measurement Stands

6852-
(page 426)

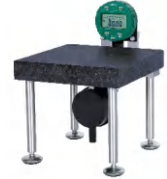

Optical Flats

4191-
(page 425)



ANGLE

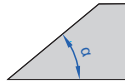

Protractors

(page 410-413)



Digital Angle Meters

2177-
(page 410)



SQUARENESS

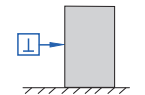

Squares

4141-, 4144-, 4710-, 4712-
(page 415-416)



Granite Squares With V Groove

4142-, 6539-
(page 498)



Protractors

2374-, 2372-, 2373-, 2771-
(page 413-415)



Perpendicularity Testers

4770-
(page 417)



Squares

(page 422-423)



Squares

(page 417-421)



Angle Gauges

4806-, 4807-
(page 451)



COAXIALITY AND RUNOUT

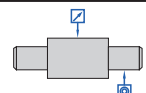

APPLICATION INDEX OF MEASURING TOOLS

Concentricity Gauges
(page 428-432)



Bench Centers
(page 433-440)



V-blocks
(page 491-495)



Magnetic V-blocks
(page 495-497)



DIAMETER OF CUTTING TOOLS WITH ODD FLUTES



V Shape Calipers
1229-, 1273-, 1539-, 1529-
(page 73-74)



V-Anvil Micrometers
3290-, 3590-
(page 177)



GEAR AND SPLINE



Spline Ring/Plug Gauges
6341-, 6342-
(page 378-379)



Digital Gear Tooth Calipers
1181-, 1281-
(page 80)

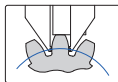

Disk Micrometers
(page 181-184)

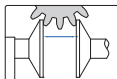

External Gear Tooth Micrometers
3291-, 3591-, 3636-
(page 159-160)

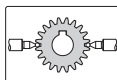

Comparison Gauges
2252-
(page 114-115)



Internal/External Measuring Gauges
2934-, 2935-, 2933-, 2932-
(page 116-123)



Internal Gear Tooth Micrometers
3638-
(page 205)



Internal Gear Tooth Micrometers
3678-
(page 199)



Universal Calipers
1125-
(page 50-51)

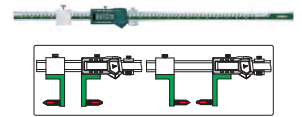

Digital Calipers With Interchangeable Points
1526-, 1124-
(page 51-53)



Gear Tooth Pitch Gauges
4860-
(page 450)



KEYWAY

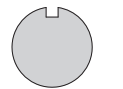

Keyway Depth Gauges
2182-, 2189-
(page 242)

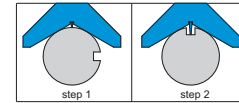

Keyway Symmetry Gauges
4865-
(page 241)



Keyway Symmetry Digital Calipers
1531-
(page 241)



THREAD

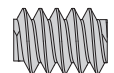

Threaded Hole Location Gauges
4662-, 4676-
(page 381-382)



APPLICATION INDEX OF MEASURING TOOLS

Thread Depth Gauges
4649-, 4666-
(page 383-384)



3-Wires
7382-, 7394-
(page 154)



External Screw Thread Micrometers
3281-, 3581-, 3680-
(page 157-158/155)

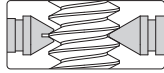

Internal Screw Thread Micrometers
3641-, 3226-
(page 205-206)

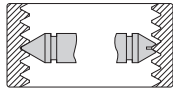

Thread/Lead Screw Pitch Diameter Snap Gauges
2165-
(page 320)



Thread Plug Gauges
(page 385-402)



Thread Ring Gauges
(page 389-396)



External Thread Measuring Devices
ISQ-TE100
(page 407-408)



Internal/External Measuring Gauges
2934-, 2935-, 2933-, 2932-
(page 116-123)



Pitch Gauges
4824-, 4820-
(page 449)



Universal Calipers
1125- (page 50-51)

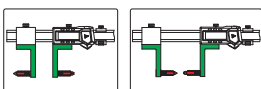

Digital Calipers With Interchangeable Points
1526-, 1124-
(page 51-53)

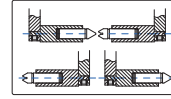

FOR OIL PIPES AND FLANGES

Thread Pitch Measuring Instruments
2235-, 2234-, 2245-
(page 329-330)



Thread Taper Measuring Instruments
2230-, 2231-, 2240-, 2241-
(page 332-334)



Thread Height Measuring Instruments
(page 335-337)



Thread Crest Diameter Measuring Instruments
2237-, 2236-, 2246-, 2247-
(page 338-341)



Digital Groove Width Measuring Instrument
2250-, 2260-
(page 343)



Digital Groove Diameter Measuring Instrument
2251-, 2261-
(page 342)



Digital Calipers With Interchangeable Ball Tips
1527-, 1528-
(page 77)



Digital RTJ Ring Groove Calipers
1179-
(page 76)





www.insize-eu.com



The products with this mark are supplied with manufacturer inspection certificate.

INSIZE Inspection Certificate

Product name: Digital Caliper Traceable to: USA NIST No.821/279484-10
Code No.: 1108-150 Germany DKD No.D-K-15190-01-00
Measuring range: 0-150mm / 0-6"
Resolution: 0.01mm / 0.0005" Inspector: *[Signature]*
Serial No.: 0910120004 Judgement: Passed
Standard temperature: 20°C / 68°F

Measuring Length	Permissible Error	Error		Measuring Length	Permissible Error	Error	
		External	Internal			External	Internal
0.4 DIA	+0.0005 -0.0010	/	0.0005	Φ10	+0.01 -0.02	/	0.01
2	±0.0010	-0.0005	/	50	±0.02	-0.01	/
4		-0.0005	/	100		-0.01	/
6		-0.0010	/	150		-0.02	/
8	±0.0015	/	/	200	±0.03	/	/
10		/	/	250		/	/
12		/	/	300		/	/

Distributed by:

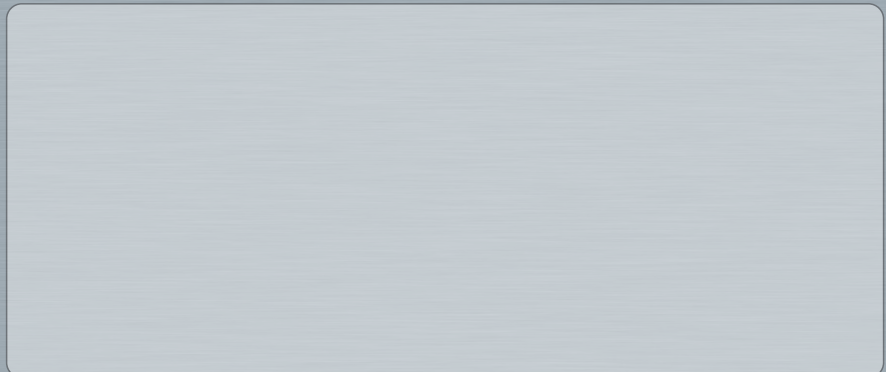

INSIZE EUROPE S.L.
Add: Aresti No 8, 48160, Derio, Spain
Tel: +34-94-4544308
E-mail: europe@insize.com
Website: www.insize-eu.com